

NOTES:

1. DESIGN: Lens mounts the Litepipe securely to display panel providing 180° viewing angle
2. MOUNTING: Panel mounting hole .250 (6.35mm) on 3/8" centers
3. PANEL THICKNESS: For CLB 300 and SQB 400: 1/32" to 1/4".
For Panels less than 3/16" use SPC 125
4. LENS LOCK: Insert Litepipe into lens aligning the tabs with the lens slot
Standoff used to adjust the height of a standard LED above the PCB and maintain a maximum .050" clearance between the Litepipe and LED.
5. Standoff used to adjust the height of a standard LED above the PCB and maintain a maximum .050" clearance between the Litepipe and LED.
6. Length is from front of panel to LED
7. Custom lengths available upon request (Minimum order quantity may apply)
8. U.S. & Foreign Pat. Issued and Pend.

REVISIONS				
ECN #	REV	DESCRIPTION	DATE	INITIALS
	N/A	INITIAL RELEASE	1/25/96	JS
	001	REVISED PER ECN111009AZ01	4/23/10	KH

D

D

C

C

B

B

A

A

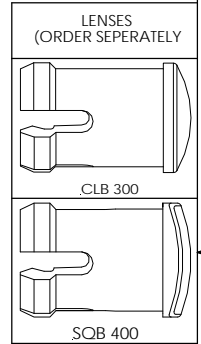
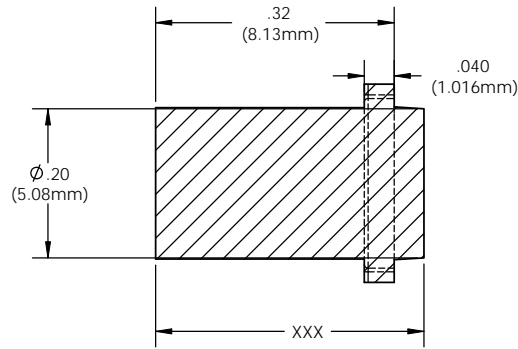
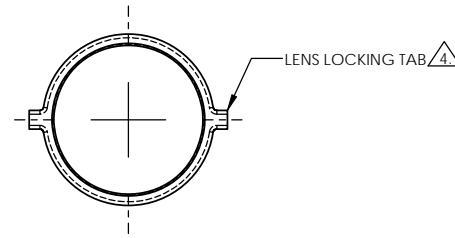
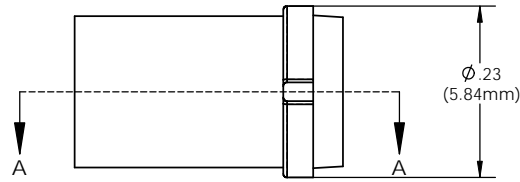
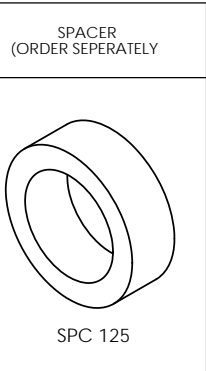

ORDERING CODE:
LCV XXX CTP

LENGTH CODE	
036	= .360"
056	.560"
076	.760"
096	.960"
116	1.160"
136	1.360"

COLOR	
CTP	CLEAR

CUSTOM LENGTHS
AVAILABLE UPON
REQUEST
(SEE NOTE7)

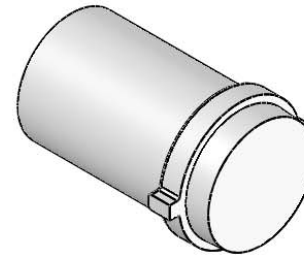
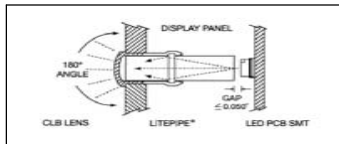

UNLESS OTHERWISE SPECIFIED DIMENSIONS ARE IN INCHES		MATERIAL		VISUAL COMMUNICATIONS COMPANY, INC.	
ANGLES ±1°	DECIMALS X ±.020 XX ±.010 XXX ±.005	ACRYLIC (OPTICAL GRADE) U.L. 94-HB		190 Bossick Boulevard, Suite 101 San Marcos, CA 92069 USA Phone (760) 560-1300 Fax (760) 560-1301 email vccsales@vccite.com	
FINISH		FINISH		TITLE:	
BREAK ALL CORNERS AND SHARP EDGES (R1 MIN)		SEE NOTES		5MM ROUND LITEPIPE	
THIRD ANGLE PROJECTION		APPROVAL	DATE	SIZE	DWG. NO.
PROPRIETARY AND CONFIDENTIAL THE INFORMATION CONTAINED IN THIS DRAWING IS THE SOLE PROPERTY OF VISUAL COMMUNICATIONS COMPANY, INC. REPRODUCTION IN PART OR AS A WHOLE WITHOUT THE WRITTEN CONSENT OF VISUAL COMMUNICATIONS COMPANY, INC. IS PROHIBITED.		DRAWN K.Howard	4/23/10	B	LCV XXX CTP
		CHECKED DPZ	5/4/10	REV	001
		DO NOT SCALE DRAWING		SCALE: 6:1 SHEET 1 OF 1	

8

7

6

5

4

3

2

1

Mouser Electronics

Authorized Distributor

Click to View Pricing, Inventory, Delivery & Lifecycle Information:

VCC:

[LCV_036_CTP](#) [LCV_056_CTP](#) [LCV_076_CTP](#) [LCV_096_CTP](#) [LCV_116_CTP](#) [LCV_136_CTP](#)