



BAS40 SERIES

SURFACE MOUNT SCHOTTKY DIODES

VOLTAGE 40 Volt **CURRENT** 0.2 Ampere

FEATURES

- Fast switching speed
- Surface mount package ideally suited for automatic insertion
Electrical identical standard JEDEC
- High conductor
- Lead free in compliance with EU RoHS 2.0
- Green molding compound as per IEC 61249 standard

MECHANICAL DATA

- Case: SOT-23, Plastic
- Terminals: Solderable per MIL-STD-750, Method 2026
- Approx. Weight: 0.0003 ounces, 0.0084 grams

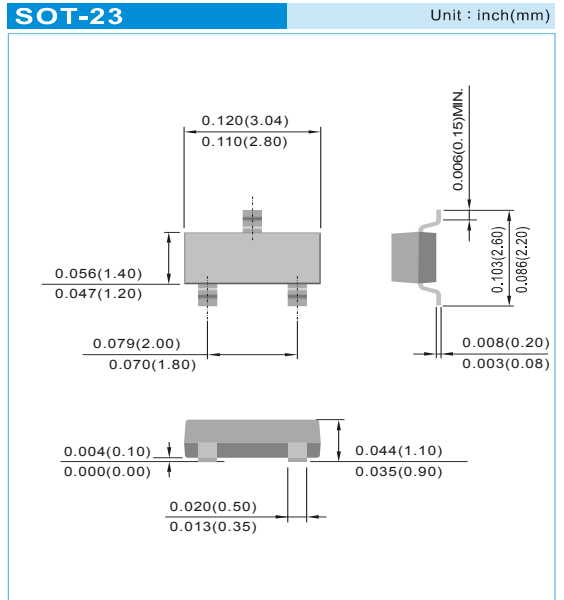

ABSOLUTE RATINGS

PARAMETER	Symbol	BAS40	BAS40A	BAS40C	BAS40S	Units
Marking Code		S40	S42	S43	S44	
Reverse Voltage	V_R	40				V
Peak Reverse Voltage	V_{RRM}	40				V
Average Rectified Current at Temp=25°C	$I_{F(AV)}$	0.2				A
Non-repetitive Peak Forward Surge Current at t=1.0 s	I_{FSM}	0.6				A

THERMAL CHARACTERISTICS

PARAMETER	Symbol	BAS40	BAS40A	BAS40C	BAS40S	Units
Power Dissipation	P_{TOT}	225				mW
Thermal Resistance , Junction to Ambient	$R_{\theta JA}$	556				°C/W
Junction Temperature	T_J	-55 to 150				°C
Storage Temperature at Temp=25°C	T_{STG}	-55 to 150				°C
Circuit Figure		SINGLE	COMMON ANODE	COMMON CATHODE	SERIES	

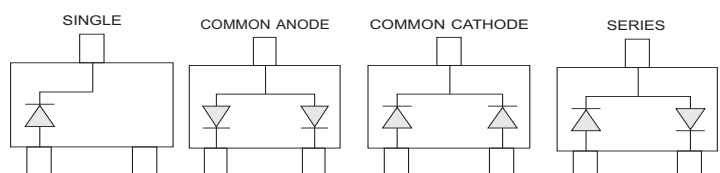



BAS40 SERIES

ELECTRICAL CHARACTERISTICS

PARAMETER	SYMBOL	TEST CONDITION	MIN.	TYP.	MAX.	UNITS
Reverse Breakdown Voltage	$V_{(BR)}$	$I_R=10 \mu A$	40	--	--	V
Reverse Current	I_R	$V_R=25 V$	--	--	1.0	μA
Forward Voltage	V_F	$I_F=1.0mA$ $I_F=10mA$ $I_F=40mA$	--	--	0.38 0.50 1.00	V
Total Capacitance	C_T	$V_R=0V, f=1.0MHz$	--	--	5.0	pF



BAS40 SERIES

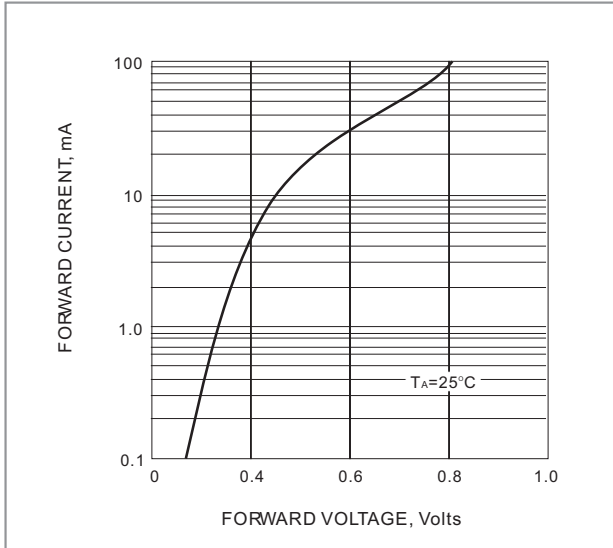

FIG. 1-TYPICAL FORWARD CHARACTERISTIC

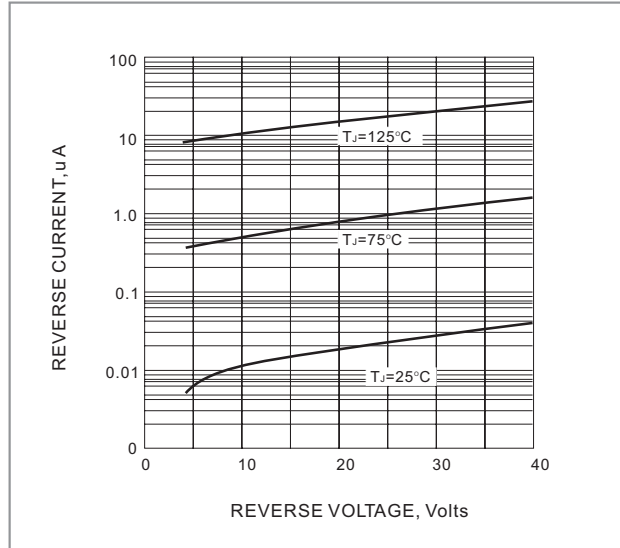

FIG. 2-TYPICAL REVERSE CHARACTERISTICS

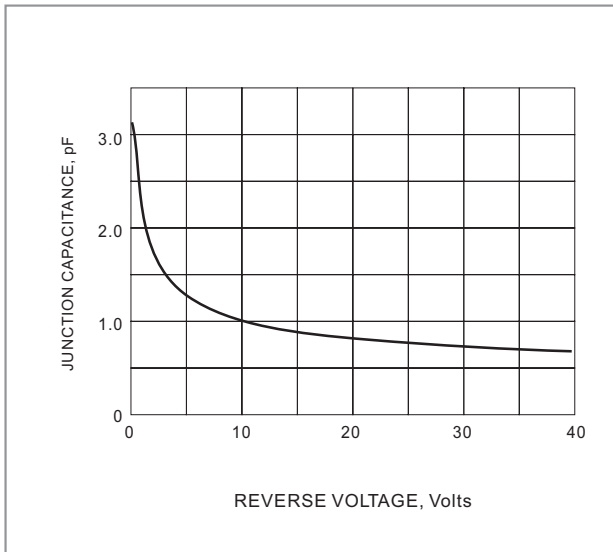

FIG. 3 TYPICAL JUNCTION CAPACITANCE

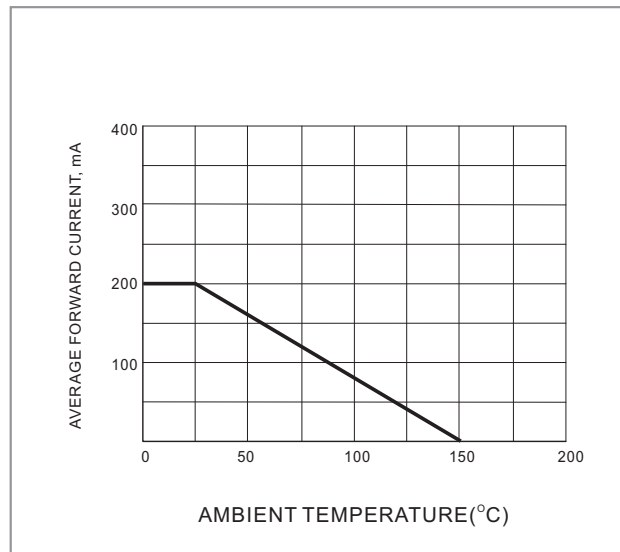

FIG. 4 FORWARD CURRENT DERATING

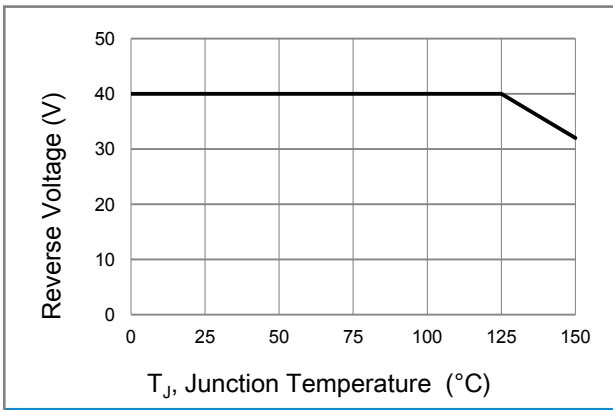

Fig.5 Operating Temperature Derating Curve



BAS40 SERIES

MOUNTING PAD LAYOUT

SOT-23

Unit : inch(mm)

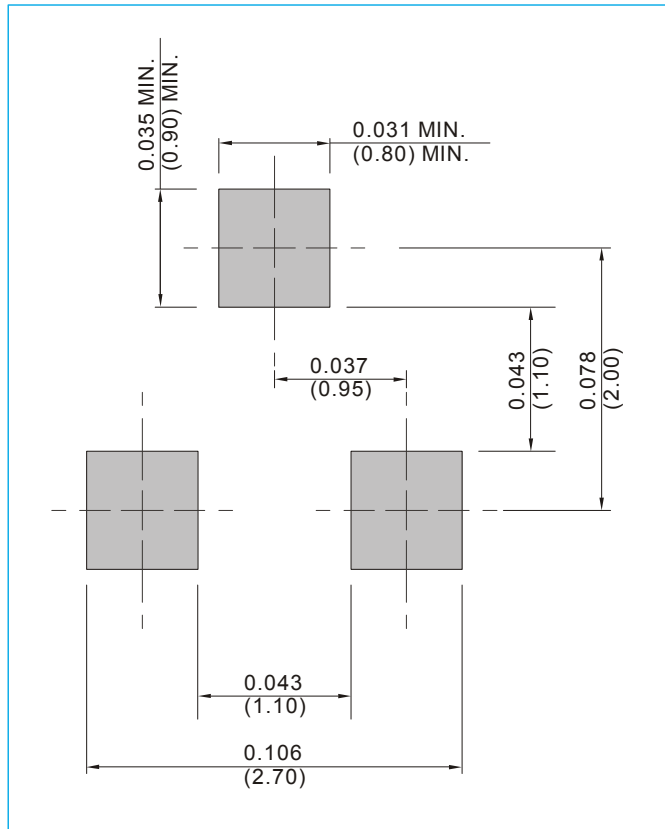

ORDER INFORMATION

- Packing information
 - T/R - 12K per 13" plastic Reel
 - T/R - 3K per 7" plastic Reel



BAS40 SERIES

Part No._packing code_Version

BAS40_R1_00001

BAS40_R2_00001

For example :

RB500V-40_R2_00001



Packing Code XX				Version Code XXXXX		
Packing type	1 st Code	Packing size code	2 nd Code	HF or RoHS	1 st Code	2 nd ~5 th Code
Tape and Ammunition Box (T/B)	A	N/A	0	HF	0	serial number
Tape and Reel (T/R)	R	7"	1	RoHS	1	serial number
Bulk Packing (B/P)	B	13"	2			
Tube Packing (T/P)	T	26mm	X			
Tape and Reel (Right Oriented) (TRR)	S	52mm	Y			
Tape and Reel (Left Oriented) (TRL)	L	PANASERT T/B CATHODE UP (PBCU)	U			
FORMING	F	PANASERT T/B CATHODE DOWN (PBCD)	D			



BAS40 SERIES

Disclaimer

- Reproducing and modifying information of the document is prohibited without permission from Panjit International Inc..
- Panjit International Inc. reserves the rights to make changes of the content herein the document anytime without notification. Please refer to our website for the latest document.
- Panjit International Inc. disclaims any and all liability arising out of the application or use of any product including damages incidentally and consequentially occurred.
- Panjit International Inc. does not assume any and all implied warranties, including warranties of fitness for particular purpose, non-infringement and merchantability.
- Applications shown on the herein document are examples of standard use and operation. Customers are responsible in comprehending the suitable use in particular applications. Panjit International Inc. makes no representation or warranty that such applications will be suitable for the specified use without further testing or modification.
- The products shown herein are not designed and authorized for equipments requiring high level of reliability or relating to human life and for any applications concerning life-saving or life-sustaining, such as medical instruments, transportation equipment, aerospace machinery et cetera. Customers using or selling these products for use in such applications do so at their own risk and agree to fully indemnify Panjit International Inc. for any damages resulting from such improper use or sale.
- Since Panjit uses lot number as the tracking base, please provide the lot number for tracking when complaining.

Mouser Electronics

Authorized Distributor

Click to View Pricing, Inventory, Delivery & Lifecycle Information:

[Panjit:](#)

[BAS40S_R1_00001](#) [BAS40S_R1_10001](#) [BAS40S_R2_00001](#) [BAS40S_R2_10001](#)