

Features

- 0805 size
- Magnetic shielding
- Height as low as 0.85 mm
- Nickel barrier
- RoHS compliant*

CV201210 Series - Ferrite Multi-Layer Chip Inductors

Applications

- Prevention of electromagnetic interference to signals on the secondary side of electronic equipment

Electrical Specifications

Bourns® Part No.	Inductance		Q	Test Freq. (MHz)	SRF (MHz)	DCR (mΩ)	I rms (mA)
	μH	Tol. %					
CV201210-47NK	0.047	±10	15	50*	320	200	300
CV201210-68NK	0.068	±10	15	50	280	200	300
CV201210-82NK	0.082	±10	15	50	255	200	300
CV201210-R10K	0.10	±10	20	25	235	300	250
CV201210-R12K	0.12	±10	20	25	220	300	250
CV201210-R15K	0.15	±10	20	25	200	400	250
CV201210-R18K	0.18	±10	20	25	185	400	250
CV201210-R22K	0.22	±10	20	25	170	500	250
CV201210-R27K	0.27	±10	20	25	150	500	250
CV201210-R33K	0.33	±10	20	25	145	550	250
CV201210-R39K	0.39	±10	25	25	135	650	200
CV201210-R47K	0.47	±10	25	25	125	650	200
CV201210-R56K	0.56	±10	25	25	115	750	150
CV201210-R68K	0.68	±10	25	25	105	800	150
CV201210-R82K	0.82	±10	25	25	100	1000	150
CV201210-1R0K	1.0	±10	45	10	75	400	50
CV201210-1R2K	1.2	±10	45	10	65	500	50
CV201210-1R5K	1.5	±10	45	10	60	500	50
CV201210-1R8K	1.8	±10	45	10	55	600	50
CV201210-2R2K	2.2	±10	45	10	50	650	30
CV201210-2R7K	2.7	±10	45	10	45	750	30
CV201210-3R3K	3.3	±10	45	10	41	800	30
CV201210-3R9K	3.9	±10	45	10	38	900	30
CV201210-4R7K	4.7	±10	45	10	35	1000	30
CV201210-5R6K	5.6	±10	45	4	32	900	15
CV201210-6R8K	6.8	±10	45	4	29	1000	15
CV201210-8R2K	8.2	±10	45	4	26	1100	15
CV201210-100K	10	±10	45	2	24	1150	15
CV201210-120K	12	±10	45	2	22	1250	5
CV201210-150K	15	±10	30	1	19	800	5
CV201210-180K	18	±10	30	1	18	900	5
CV201210-220K	22	±10	30	1	16	1100	5
CV201210-270K	27	±10	30	1	14	1150	5
CV201210-330K	33	±10	30	0.4	13	1250	5

*Test Frequency for L (inductance) of CV201210-47NK is 10 MHz.

Packaging Specifications

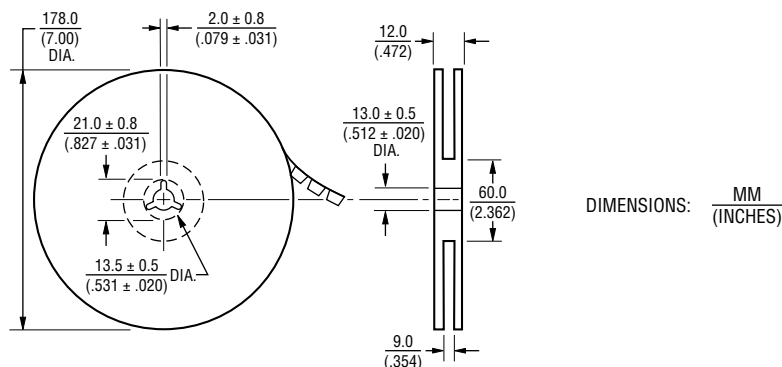

Additional Information

Click these links for more information:



General Specifications

Inductance Test Voltage 60 mV
 Temperature Rise 30 °C max. at rated current
 Operating Temperature -55 °C to +125 °C
 Storage Temperature -55 °C to +125 °C
 Reflow Soldering ... 230 °C, 50 sec. max.
 Resistance to Soldering Heat +260 °C, 10 seconds

Materials

Base Material..... Ferrite
 Terminal Ag/Ni/Sn
 Packaging
 0.85 mm Product Height 4,000 pcs. per reel
 1.25 mm Product Height 2,000 pcs. per reel

Product Dimensions

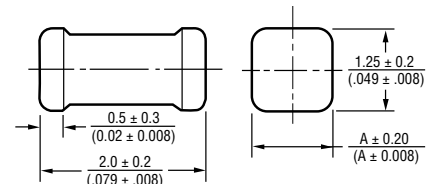

DIMENSIONS: $\frac{\text{MM}}{\text{(INCHES)}}$

Model	Dim. A
CV201210-47NK through CV201210-R39K	0.85 (0.033)
CV201210-R47K through CV201210-R82K	1.25 (0.050)
CV201210-1R0K through CV201210-2R2K	0.85 (0.033)
CV201210-2R7K through CV201210-330K	1.25 (0.050)

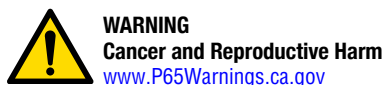

* RoHS Directive 2015/863, Mar 31, 2015 and Annex. Specifications are subject to change without notice. Users should verify actual device performance in their specific applications. The products described herein and this document are subject to specific legal disclaimers as set forth on the last page of this document, and at www.bourns.com/docs/legal/disclaimer.pdf.

CV201210 Series - Ferrite Multi-Layer Chip Inductors

BOURNS®

Recommended Layout

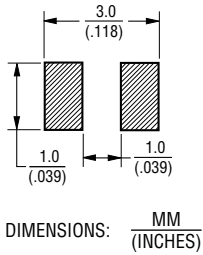

Solder Profile

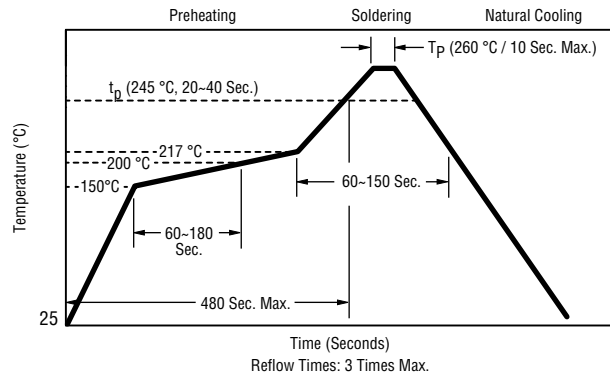

Electrical Specifications

Q Characteristics

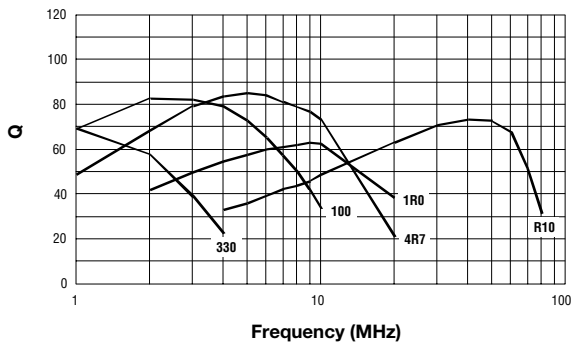

DC Bias Characteristics

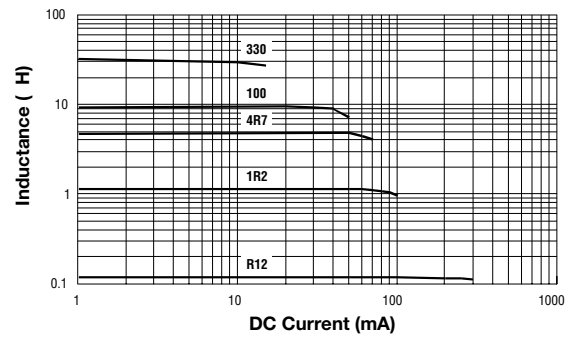

Inductance Characteristics

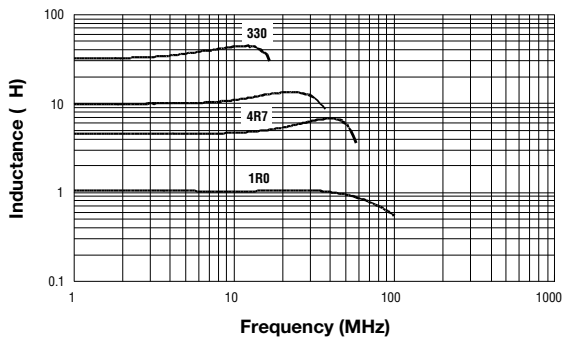

Impedance Characteristics

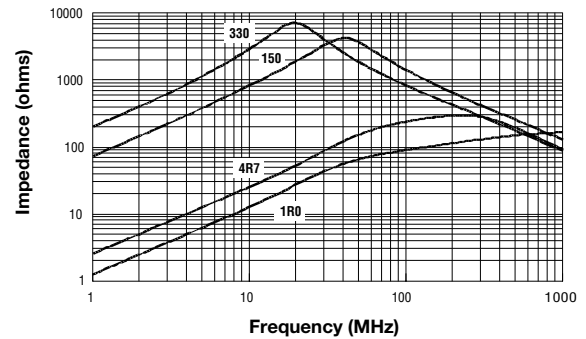

REV. 04/21

Specifications are subject to change without notice.

Users should verify actual device performance in their specific applications.

The products described herein and this document are subject to specific legal disclaimers as set forth on the last page of this document, and at www.bourns.com/docs/legal/disclaimer.pdf.

This legal disclaimer applies to purchasers and users of Bourns® products manufactured by or on behalf of Bourns, Inc. and its affiliates (collectively, “Bourns”).

Unless otherwise expressly indicated in writing, Bourns® products and data sheets relating thereto are subject to change without notice. Users should check for and obtain the latest relevant information and verify that such information is current and complete before placing orders for Bourns® products.

The characteristics and parameters of a Bourns® product set forth in its data sheet are based on laboratory conditions, and statements regarding the suitability of products for certain types of applications are based on Bourns’ knowledge of typical requirements in generic applications. The characteristics and parameters of a Bourns® product in a user application may vary from the data sheet characteristics and parameters due to (i) the combination of the Bourns® product with other components in the user’s application, or (ii) the environment of the user application itself. The characteristics and parameters of a Bourns® product also can and do vary in different applications and actual performance may vary over time. Users should always verify the actual performance of the Bourns® product in their specific devices and applications, and make their own independent judgments regarding the amount of additional test margin to design into their device or application to compensate for differences between laboratory and real world conditions.

Unless Bourns has explicitly designated an individual Bourns® product as meeting the requirements of a particular industry standard (e.g., ISO/TS 16949) or a particular qualification (e.g., UL listed or recognized), Bourns is not responsible for any failure of an individual Bourns® product to meet the requirements of such industry standard or particular qualification. Users of Bourns® products are responsible for ensuring compliance with safety-related requirements and standards applicable to their devices or applications.

Bourns® products are not recommended, authorized or intended for use in nuclear, lifesaving, life-critical or life-sustaining applications, nor in any other applications where failure or malfunction may result in personal injury, death, or severe property or environmental damage. Unless expressly and specifically approved in writing by two authorized Bourns representatives on a case-by-case basis, use of any Bourns® products in such unauthorized applications might not be safe and thus is at the user’s sole risk. Life-critical applications include devices identified by the U.S. Food and Drug Administration as Class III devices and generally equivalent classifications outside of the United States.

Bourns expressly identifies those Bourns® standard products that are suitable for use in automotive applications on such products’ data sheets in the section entitled “Applications.” Unless expressly and specifically approved in writing by two authorized Bourns representatives on a case-by-case basis, use of any other Bourns® standard products in an automotive application might not be safe and thus is not recommended, authorized or intended and is at the user’s sole risk. If Bourns expressly identifies a sub-category of automotive application in the data sheet for its standard products (such as infotainment or lighting), such identification means that Bourns has reviewed its standard product and has determined that if such Bourns® standard product is considered for potential use in automotive applications, it should only be used in such sub-category of automotive applications. Any reference to Bourns® standard product in the data sheet as compliant with the AEC-Q standard or “automotive grade” does not by itself mean that Bourns has approved such product for use in an automotive application.

Bourns® standard products are not tested to comply with United States Federal Aviation Administration standards generally or any other generally equivalent governmental organization standard applicable to products designed or manufactured for use in aircraft or space applications. Bourns expressly identifies Bourns® standard products that are suitable for use in aircraft or space applications on such products’ data sheets in the section entitled “Applications.” Unless expressly and specifically approved in writing by two authorized Bourns representatives on a case-by-case basis, use of any other Bourns® standard product in an aircraft or space application might not be safe and thus is not recommended, authorized or intended and is at the user’s sole risk.

The use and level of testing applicable to Bourns® custom products shall be negotiated on a case-by-case basis by Bourns and the user for which such Bourns® custom products are specially designed. Absent a written agreement between Bourns and the user regarding the use and level of such testing, the above provisions applicable to Bourns® standard products shall also apply to such Bourns® custom products.

Users shall not sell, transfer, export or re-export any Bourns® products or technology for use in activities which involve the design, development, production, use or stockpiling of nuclear, chemical or biological weapons or missiles, nor shall they use Bourns® products or technology in any facility which engages in activities relating to such devices. The foregoing restrictions apply to all uses and applications that violate national or international prohibitions, including embargos or international regulations. Further, Bourns® products and Bourns technology and technical data may not under any circumstance be exported or re-exported to countries subject to international sanctions or embargoes. Bourns® products may not, without prior authorization from Bourns and/or the U.S. Government, be resold, transferred, or re-exported to any party not eligible to receive U.S. commodities, software, and technical data.

To the maximum extent permitted by applicable law, Bourns disclaims (i) any and all liability for special, punitive, consequential, incidental or indirect damages or lost revenues or lost profits, and (ii) any and all implied warranties, including implied warranties of fitness for particular purpose, non-infringement and merchantability.

For your convenience, copies of this Legal Disclaimer Notice with German, Spanish, Japanese, Traditional Chinese and Simplified Chinese bilingual versions are available at:

Web Page: <http://www.bourns.com/legal/disclaimers-terms-and-policies>

PDF: <http://www.bourns.com/docs/Legal/disclaimer.pdf>