



TISP4015L1AJ, TISP4030L1AJ, TISP4040L1AJ
 TISP4015L1BJ, TISP4030L1BJ, TISP4040L1BJ

**VERY LOW VOLTAGE
 BIDIRECTIONAL THYRISTOR OVERVOLTAGE PROTECTORS**

TISP40xxL1AJ/BJ VLV Overvoltage Protectors

Low Capacitance

'4015.....	28 pF
'4030.....	27 pF
'4040.....	23 pF

Digital Line Signal Level Protection

- ISDN
- xDSL

Safety Extra Low Voltage, SELV, values

Device	V _{DRM} V	V _(BO) V
'4015	± 8	± 15
'4030	± 15	± 30
'4040	± 25	± 40

30 A "L" Series specified for:

- ITU-T recommendations K.20, K.45, K.21
- FCC Part 68 and GR-1089-CORE

Wave Shape	Standard	I _{TSP} A
2/10 μs	GR-1089-CORE	150
8/20 μs	IEC 61000-4-5	120
10/160 μs	FCC Part 68	65
10/700 μs	ITU-T K.20/45/21 FCC Part 68	45
10/560 μs	FCC Part 68	35
10/1000 μs	GR-1089-CORE	30

Available in SMA and SMB Packages
SMA Saves 25 % Placement Area Over SMB

Description

These devices are designed to limit overvoltages on digital telecommunication lines. Overvoltages are normally caused by a.c. power system or lightning flash disturbances which are induced or conducted on to the telephone line. A single device provides 2-point protection and is typically used for the protection of transformer windings and low voltage electronics.

The protector consists of a symmetrical voltage-triggered bidirectional thyristor. Overvoltages are initially clipped by breakdown clamping until the voltage rises to the breakover level, which causes the device to crowbar into a low-voltage on-state condition. This low-voltage on state causes the current resulting from the overvoltage to be safely diverted through the device. The device switches off when the diverted current falls below the holding current value.

How to Order

Device	Package	Carrier	Order As
TISP40xxL1	SMA/DO-214AC J-Bend (AJ)	Embossed Tape Reeled (R)	TISP40xxL1AJR-S
	SMB/DO-214AA J-Bend (BJ)		TISP40xxL1BJR-S

Insert xx value corresponding to protection voltages of 15 V, 30 V and 40 V.



WARNING Cancer and Reproductive Harm
www.P65Warnings.ca.gov

Agency Recognition

Description	
UL	File Number: E215609

SMA Package (Top View)

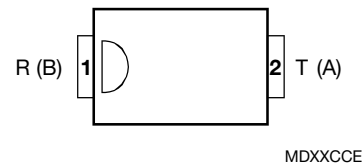

SMB Package (Top View)

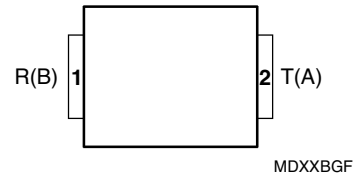

Device Symbol

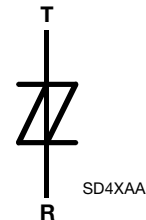

Terminals T and R correspond to the alternative line designators of A and B

..... **UL Recognized Components**

AUGUST 1999 – REVISED JULY 2019
 *RoHS Directive 2015/863, Mar 31, 2015 and Annex.
 Specifications are subject to change without notice.
 Users should verify actual device performance in their specific applications.
 The products described herein and this document are subject to specific legal disclaimers as set forth on the last page of this document, and at www.bourns.com/docs/legal/disclaimer.pdf.

TISP40xxL1AJ/BJ VLV Overvoltage Protectors

BOURNS®

Absolute Maximum Ratings, $T_A = 25\text{ }^\circ\text{C}$ (Unless Otherwise Noted)

Rating	Symbol	Value	Unit
Repetitive peak off-state voltage	V_{DRM}	± 8	V
		± 15	
		± 25	
Non-repetitive peak on-state pulse current (see Notes 1 and 2) 2/10 μs (Telcordia GR-1089-CORE, 2/10 μs voltage wave shape) 8/20 μs (IEC 61000-4-5, combination wave generator, 1.2/50 voltage, 8/20 current) 10/160 μs (FCC Part 68, 10/160 μs voltage wave shape) 5/310 μs (ITU-T K.20/45/21, 10/700 μs voltage wave shape) 5/320 μs (FCC Part 68, 9/720 μs voltage wave shape) 10/560 μs (FCC Part 68, 10/560 μs voltage wave shape) 10/1000 μs (Telcordia GR-1089-CORE, 10/1000 μs voltage wave shape)	I_{TSP}	± 150	A
		± 120	
		± 65	
		± 45	
		± 45	
		± 35	
		± 30	
Non-repetitive peak on-state current (see Notes 1 and 2) 20 ms (50 Hz) full sine wave 16.7 ms (60 Hz) full sine wave 0.2 s 50 Hz/60 Hz a.c. 2 s 50 Hz/60 Hz a.c. 1000 s 50 Hz/60 Hz a.c.	I_{TSM}	20	A
		22	
		13	
		5	
		1.8	
Initial rate of rise of current (2/10 waveshape)	di/dt	130	A/ μs
Maximum junction temperature	T_{JM}	150	$^\circ\text{C}$
Storage temperature range	T_{stg}	-65 to +150	$^\circ\text{C}$

- NOTES: 1. Initially, the device must be in thermal equilibrium with $T_J = 25\text{ }^\circ\text{C}$.
 2. The surge may be repeated after the device returns to its initial conditions.

Electrical Characteristics, $T_A = 25\text{ }^\circ\text{C}$ (Unless Otherwise Noted)

Parameter	Test Conditions	Min	Typ	Max	Unit
I_{DRM} Repetitive peak off-state current	$V_D = V_{\text{DRM}}$			± 5	μA
$V_{(\text{BO})}$ Breakover voltage	$di/dt = \pm 0.8\text{ A/ms}$	'4015		± 15	V
		'4030		± 30	
		'4040		± 40	
$V_{(\text{BO})}$ Impulse breakover voltage	$dv/dt = \pm 1000\text{ V}/\mu\text{s}$, Linear voltage ramp, Maximum ramp value = $\pm 500\text{ V}$ $di/dt = \pm 5\text{ A}/\mu\text{s}$, Linear current ramp, Maximum ramp value = $\pm 10\text{ A}$	'4015		± 34	V
		'4030		± 50	
		'4040		± 63	
$I_{(\text{BO})}$ Breakover current	$di/dt = \pm 0.8\text{ A/ms}$			± 0.8	A
I_D Off-state current	$V_D = \pm 6\text{ V}$	'4015			μA
	$V_D = \pm 13\text{ V}$	'4030		± 2	
	$V_D = \pm 22\text{ V}$	'4040			
I_H Holding current	$I_T = \pm 5\text{ A}$, $di/dt = \pm 30\text{ mA/ms}$	± 50			mA

AUGUST 1999 – REVISED JULY 2019

Specifications are subject to change without notice.

Users should verify actual device performance in their specific applications.

The products described herein and this document are subject to specific legal disclaimers as set forth on the last page of this document, and at www.bourns.com/docs/legal/disclaimer.pdf.

TISP40xxL1AJ/BJ VLV Overvoltage Protectors

BOURNS®

Electrical Characteristics, $T_A = 25\text{ °C}$ (Unless Otherwise Noted)

Parameter	Test Conditions	Min	Typ	Max	Unit
C_{off} Off-state capacitance	f = 1 MHz, $V_d = 1\text{ V rms}$, $V_D = 0$	'4015	28	36	pF
		'4030	27	35	
		'4040	23	29	
	f = 1 MHz, $V_d = 1\text{ V rms}$, $V_D = 1\text{ V}$	'4015	25	33	
		'4030	24	31	
		'4040	20	26	
	f = 1 MHz, $V_d = 1\text{ V rms}$, $V_D = 2\text{ V}$	'4015	23	30	
		'4030	22	29	
		'4040	18	24	

Thermal Characteristics

Parameter	Test Conditions	Min	Typ	Max	Unit
$R_{\theta JA}$ Junction to free air thermal resistance	EIA/JESD51-3 PCB, $I_T = I_{TSM(1000)}$, SMA			125	°C/W
	$T_A = 25\text{ °C}$, (see Note 3) SMB			120	
	265 mm x 210 mm populated line card, SMA		60		
	4-layer PCB, $I_T = I_{TSM(1000)}$, $T_A = 25\text{ °C}$ SMB		55		

NOTE 3: EIA/JESD51-2 environment and PCB has standard footprint dimensions connected with 5 A rated printed wiring track widths.

AUGUST 1999 – REVISED JULY 2019

Specifications are subject to change without notice.

Users should verify actual device performance in their specific applications.

The products described herein and this document are subject to specific legal disclaimers as set forth on the last page of this document, and at www.bourns.com/docs/legal/disclaimer.pdf.

Parameter Measurement Information

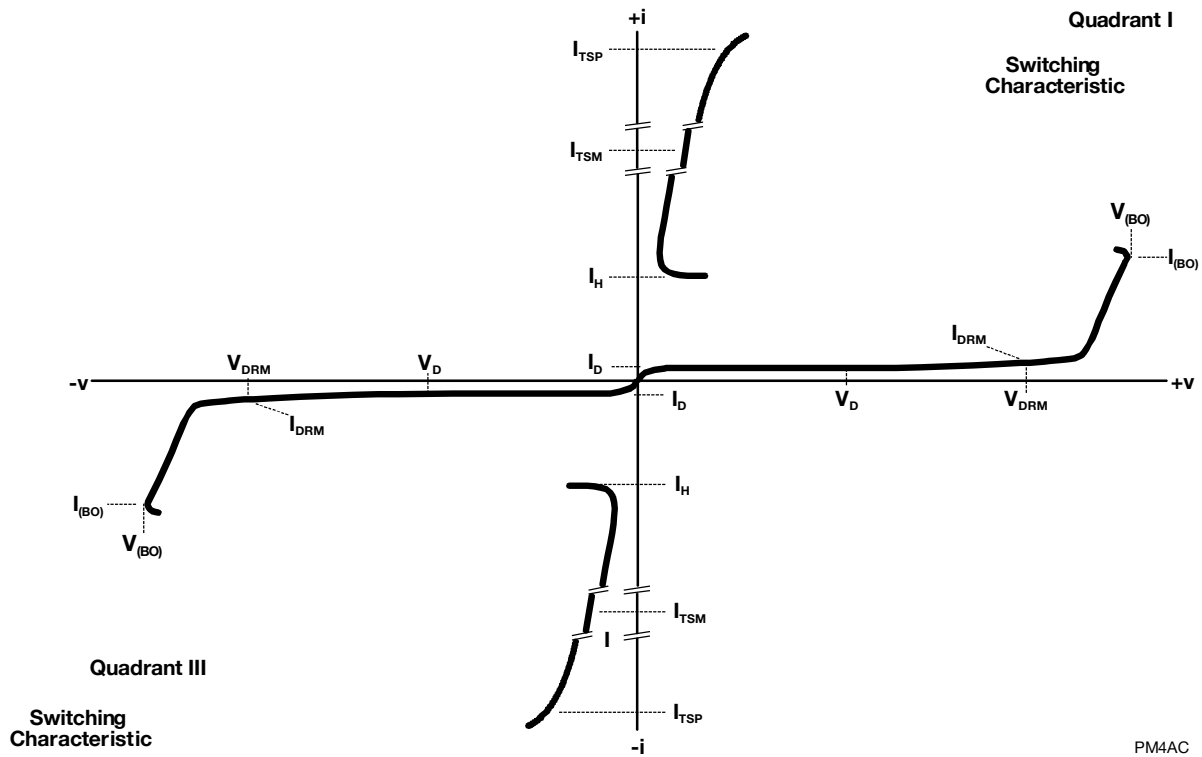

PM4AC

Figure 1. Voltage-Current Characteristic for T and R Terminals
All Measurements are Referenced to the R Terminal

Typical Characteristics

**OFF-STATE CURRENT
vs
JUNCTION TEMPERATURE**

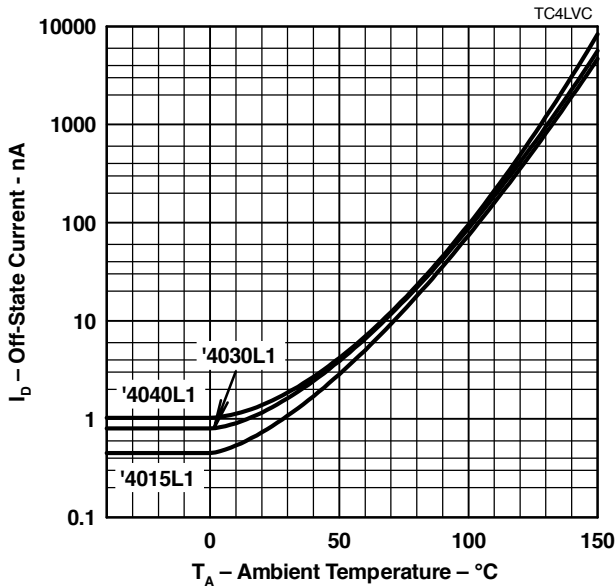

Figure 2.

**NORMALIZED BREAKOVER VOLTAGE
vs
JUNCTION TEMPERATURE**

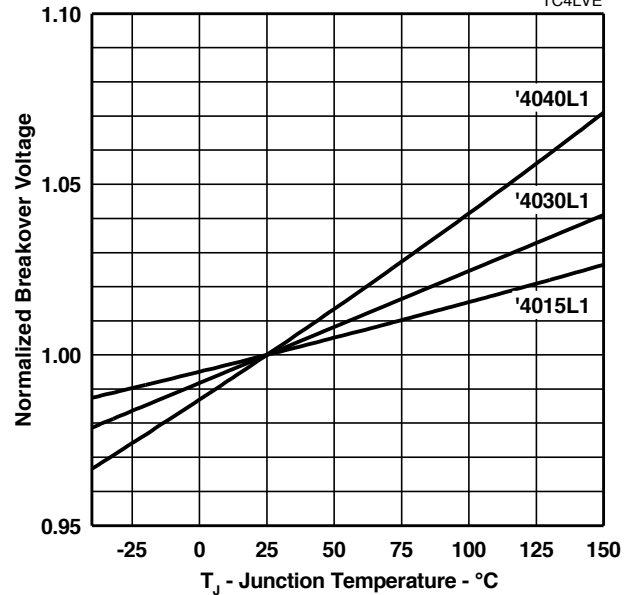

Figure 3.

**ON-STATE CURRENT
vs
ON-STATE VOLTAGE**

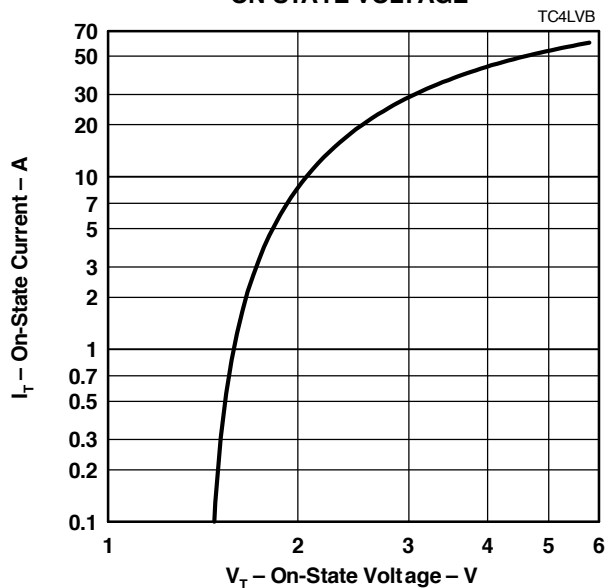

Figure 4.

**NORMALIZED HOLDING CURRENT
vs
JUNCTION TEMPERATURE**

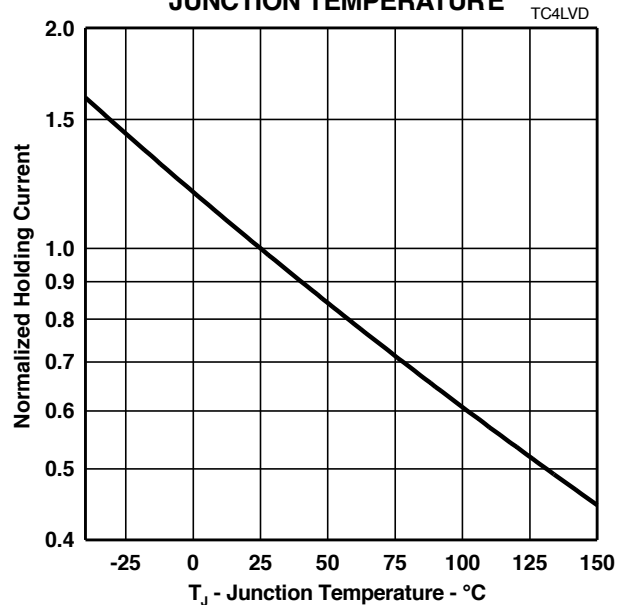

Figure 5.

AUGUST 1999 – REVISED JULY 2019

Specifications are subject to change without notice.

Users should verify actual device performance in their specific applications.

The products described herein and this document are subject to specific legal disclaimers as set forth on the last page of this document, and at www.bourns.com/docs/legal/disclaimer.pdf.

Typical Characteristics

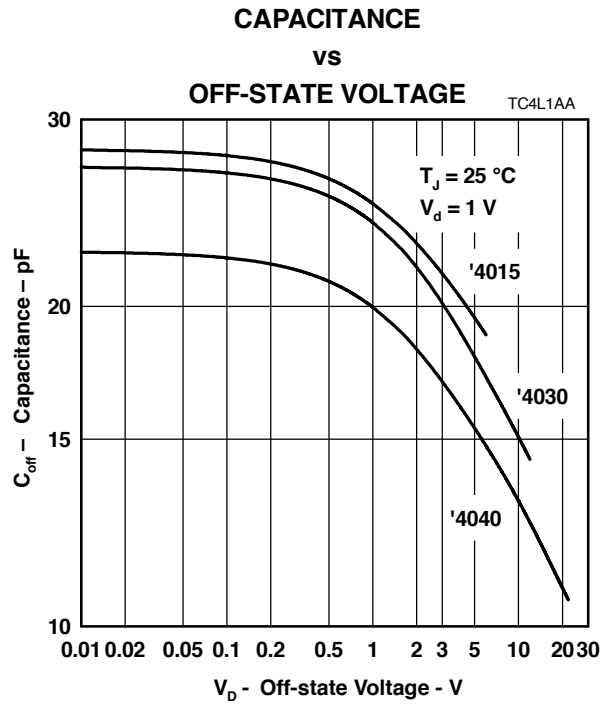

Rating and Thermal Information

NON-REPETITIVE PEAK ON-STATE CURRENT vs CURRENT DURATION

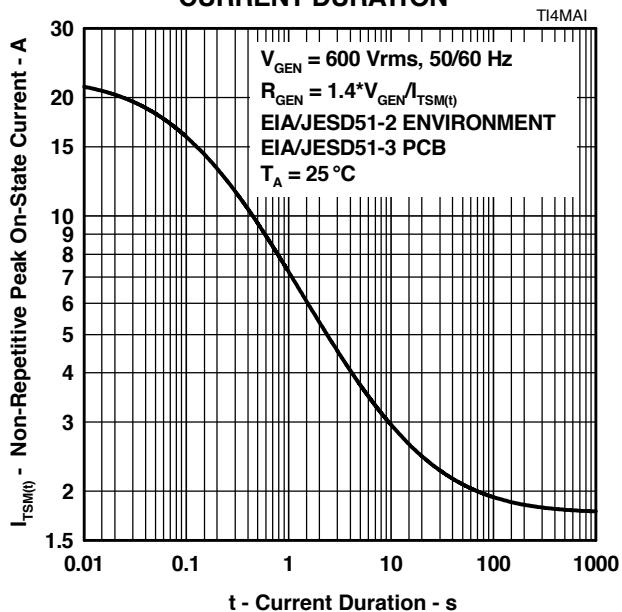

Figure 7.

V_{DRM} DERATING FACTOR vs MINIMUM AMBIENT TEMPERATURE

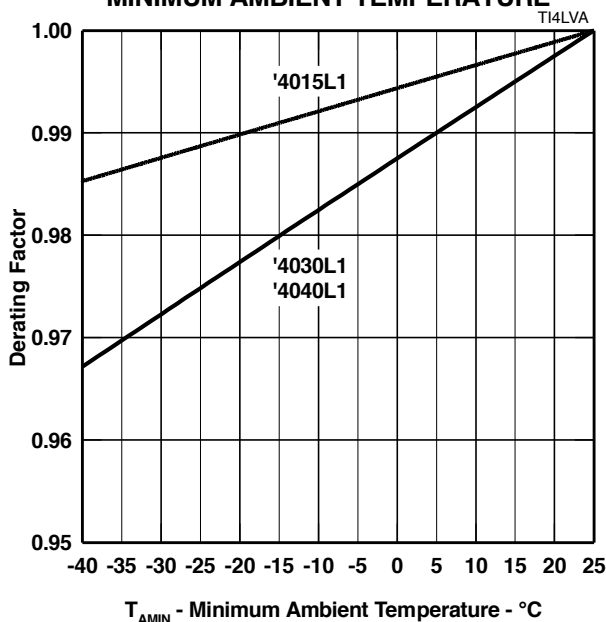

Figure 8.

AUGUST 1999 – REVISED JULY 2019

Specifications are subject to change without notice.

Users should verify actual device performance in their specific applications.

The products described herein and this document are subject to specific legal disclaimers as set forth on the last page of this document, and at www.bourns.com/docs/legal/disclaimer.pdf.

APPLICATIONS INFORMATION

Transformer Protection

The inductance of a transformer winding reduces considerably when the magnetic core material saturates. Saturation occurs when the magnetizing current through the winding inductance exceeds a certain value. It should be noted that this is a different current to the transformed current component from primary to secondary. The standard inductance-current relationship is:

$$E = -\left(L \frac{di}{dt}\right)$$

where:

L = unsaturated inductance value in H

di = current change in A

dt = time period in s for current change di

E = winding voltage in V

Rearranging this equation and working large Δ changes to saturation gives the useful circuit relationship of:

$$E \times \Delta t = L \times \Delta i$$

A transformer winding volt-second value for saturation gives the designer an idea of circuit operation under overvoltage conditions. The volt-second value is not normally quoted, but most manufacturers should provide it on request. A 50 V μ s winding will support rectangular voltage pulses of 50 V for 1 μ s, 25 V for 2 μ s, 1 V for 50 μ s and so on. Once the transformer saturates, primary to secondary coupling will be lost and the winding resistance, RW, shunts the overvoltage protector, Th1 - see Figure 9. This saturated condition is a concern for long duration impulses and a.c. fault conditions because the current capability of the winding wire may be exceeded. For example, if the on-state voltage of the protector is 1 V and the winding resistance is 0.2 Ω , the winding would bypass a current of 1/0.2 = 5 A, even though the protector was in the low voltage condition.

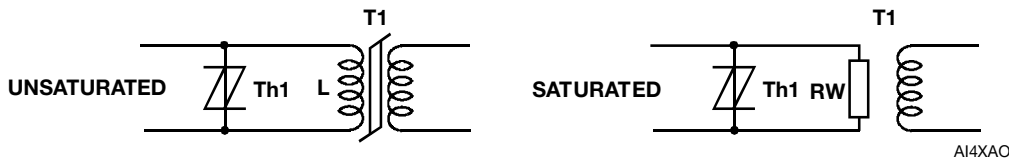

Figure 9. Transformer Saturation

Figure 10 shows a generic protection arrangement. Resistors R1 and R2, together with the overcurrent protection, prevent excessive winding current flow under a.c. conditions. Normally these resistors would only be needed for special cases, e.g. some T1/E1 designs. Alternatively, a split winding could be used with a single resistor connecting the windings. This resistor could be by-passed by a small capacitor to reduce signal attenuation.

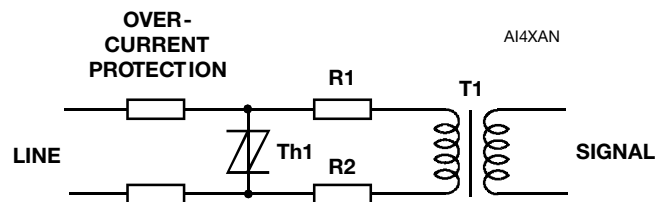

Figure 10. Transformer Winding Protection

Overcurrent protection upstream from the overvoltage protector can be fuse, PTC or thick film resistor based. For very high frequency circuits, fuse inductance due to spiral wound elements may need to be evaluated.

TISP® Device Voltage Selection

Normally, the working voltage value of the protector, V_{DRM} , would be chosen to be just greater than the peak signal amplitude over the equipment temperature range. This would give the lowest possible protection voltage, $V_{(BO)}$. This would minimize the peak voltage applied to the transformer winding and increase the time to core saturation.

In high frequency circuits, there are two further considerations. Low voltage protectors have a higher capacitance than high voltage protectors.

AUGUST 1999 – REVISED JULY 2019

Specifications are subject to change without notice.

Users should verify actual device performance in their specific applications.

The products described herein and this document are subject to specific legal disclaimers as set forth on the last page of this document, and at www.bourns.com/docs/legal/disclaimer.pdf.

TISP® Device Voltage Selection (Continued)

So a higher voltage protector might be chosen specifically to reduce the protector capacitive effects on the signal.

Low energy short duration spikes will be clipped by the protector. This will extend the spike duration and the data loss time. A higher protector voltage will reduce the data loss time. Generally, this will not be a significant factor for inter-conductor protection.

However, clipping is significant for protection to ground, where there is continuous low-level a.c. common mode induction. In some cases the induced a.c. voltage can be over 10 V. Repetitive clipping at the induced a.c. peaks by the protector would cause severe data corruption. The expected a.c. voltage induced should be added to the maximum signal level for setting the protector V_{DRM} value.

2-Wire Digital Systems

Typical systems using a single twisted pair connection are: Integrated Services Digital Network (ISDN) and Pair Gain.

Signal level protection at the transformer winding is given by protectors Th3 and Th5. Typically these could be TISP4015L1 type devices with a 15 V voltage protection level.

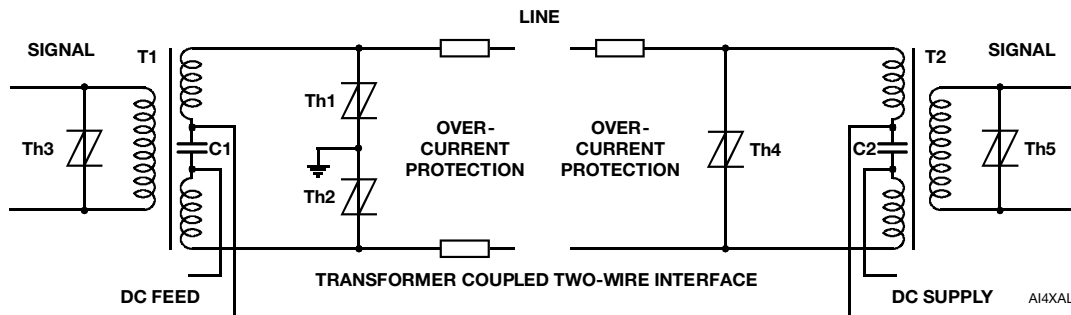

Figure 11. 2-Wire System

Two line protection circuits are given; one referenced to ground using Th1 and Th2 (left) and the other inter-wire using protector Th4 (right) - see Figure 11. For ISDN circuits compliant to ETSI ETR 080:1993, ranges 1 and 2 can be protected by the following device types: TISP4095M3, TISP4095H3, TISP3095H3 (combines Th1 and Th2) and TISP7095H3 (combines Th1, Th2 and Th4). Ranges 4 through 5 can be protected by: TISP4145M3, TISP4145H3, TISP3145H3 (combines Th1 and Th2) and TISP7145H3 (combines Th1, Th2 and Th4). Device surge requirement, H or M, will be set by the overcurrent protection components and the standards complied with. Protection of just the d.c. feed to ETSI ranges is covered in the TISP5xxxH3 data sheet.

When loop test voltages exceed the normal d.c. feed levels, higher voltage protectors need to be selected. For two terminal protectors, for levels up to 190 V (135 V rms) the TISP4250, H3 or M3, can be used and for 210 V (150 V rms) the TISP4290, H3 or M3, can be used.

In Pair Gain systems, the protector V_{DRM} is normally set by the d.c. feed value. The following series of devices have a 160 V working voltage at 25 °C: TISP4220M3, TISP4220H3, TISP3210H3 (combines Th1 and Th2) and TISP7210H3 (combines Th1, Th2 and Th4). These devices can be used on 150 V d.c. feed voltages down to an ambient temperature of -25 °C. Where the subscriber equipment may be exposed to POTS (Plain Old Telephone Service) voltage levels, protector Th4 needs a higher working voltage of about 275 V. Suitable device types are: TISP4350M3, TISP4350H3, TISP3350H3 (combines Th1 and Th2) and TISP7350H3 (combines Th1, Th2 and Th4).

The overcurrent protection for the overvoltage protector can be fuse, PTC or thick film resistor based. Its a.c. limiting capability should be less than the ratings of the intended overvoltage protector. Equipment complying with the year 2000 international K.20, K.21 and K.45 recommendations from the ITU-T, may be required to demonstrate protection coordination with the intended primary protector. Without adding series resistance, a simple series fuse overcurrent protection is likely to fail the equipment for this part of the recommendation.

If the d.c. feed consists of equal magnitude positive and negative voltage supplies, appropriately connected TISP5xxxH3 unidirectional protectors could replace Th1 and Th2.

4-Wire Digital Systems

A typical system using a two twisted pair connection is the High-bit-rate Digital Subscriber Line (HDSL) and the “S” interface of ISDN.

Figure 12 shows a generic two line system. HDSL tends to have ground referenced protection at both ends of the lines (Th1, Th2, Th3 and Th4). The ISDN “S” interface is often inside the premises and simple inter-wire protection is used at the terminating adaptor (Th7 and Th8). In all cases, signal protection, Th5, Th6, Th9 and Th10, can be TISP4015L1 type devices with a 15 V voltage protection level.

AUGUST 1999 – REVISED JULY 2019

Specifications are subject to change without notice.

Users should verify actual device performance in their specific applications.

The products described herein and this document are subject to specific legal disclaimers as set forth on the last page of this document, and at www.bourns.com/docs/legal/disclaimer.pdf.

4-Wire Digital Systems (Continued)

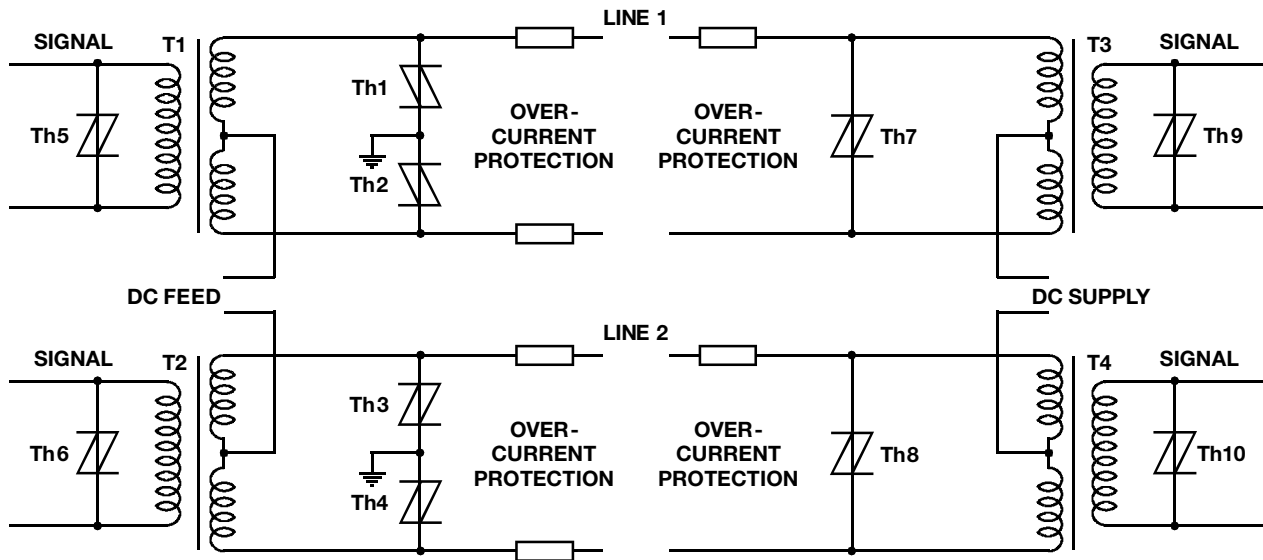

TRANSFORMER COUPLED FOUR-WIRE INTERFACE

Figure 12. 4-Wire System

AI4XAM

For an HDSL d.c. feed voltage of 180 V or less and operation down to an ambient of -25 °C, the following Th1, Th2, Th3 and Th4 protectors are suitable: TISP4250M3 or TISP4250H3, TISP3250H3 (combines Th1 and Th2 or Th3 and Th4) and TISP7250H3 (combines Th1, Th2 and Th7 or Th3, Th4 and Th8). Possible overcurrent protection components are covered in the 2-wire digital systems clause.

For ISDN interfaces powered with ±40 V (ETSI, ETS 300 012 1992) the following Th1, Th2, Th3 and Th4 protectors are suitable: TISP4070M3 or TISP4070H3 or TISP4070L3, TISP3070F3 or TISP3070H3 (combines Th1 and Th2 or Th3 and Th4) and TISP7070F3 or TISP7070H3 (combines Th1, Th2 and Th7 or Th3, Th4 and Th8). At the terminating adaptor, the Th7 and Th8 protectors do not “see” the d.c. feed voltage and should be selected to not clip the maximum signal level. Generally, the TISP40xxL1 series will be suitable.

Internal ISDN lines are not exposed to high stress levels and the chances of a.c. power intrusion are low (ETSI EN 300 386-2 1997). Accordingly, the equipment port protection needs are at a lower level than ports connected to outside lines.

Home Phone Networking

Using the existing house telephone wiring, home phone networking systems place the local network traffic in a high band above the POTS and ADSL (Asymmetrical Digital Subscriber Line) spectrum. Local network rates are 1 Mbps or more. To reject noise and harmonics, an in-line protection and 5 MHz to 10 MHz bandpass filter module is used for the equipment. These modules are available from magnetic component manufacturers (e.g. Bel Fuse Inc.) A typical circuit for the telephone line magnetics module is shown in Figure 13. Transformer T1 isolates the equipment from the house wiring. The isolated winding output is voltage limited by a very low-voltage protector, Th1. With a differential voltage of about 12 V peak to peak, the TISP4015L1 could be used for Th1. After filtering, connection is made to the differential transceiver of the processing IC.

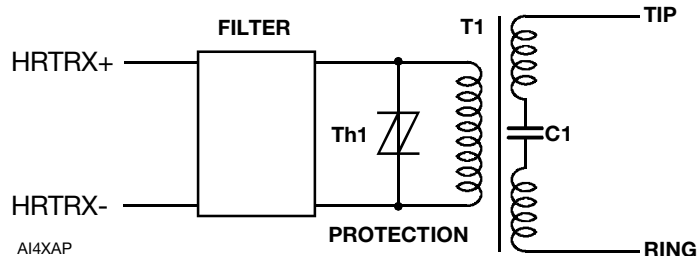

Figure 13. Home Phone Networking Isolation/filter/protection Circuit

AI4XAP

AUGUST 1999 – REVISED JULY 2019

Specifications are subject to change without notice.

Users should verify actual device performance in their specific applications.

The products described herein and this document are subject to specific legal disclaimers as set forth on the last page of this document, and at www.bourns.com/docs/legal/disclaimer.pdf.

MECHANICAL DATA

Recommended Printed Wiring Land Pattern Dimensions

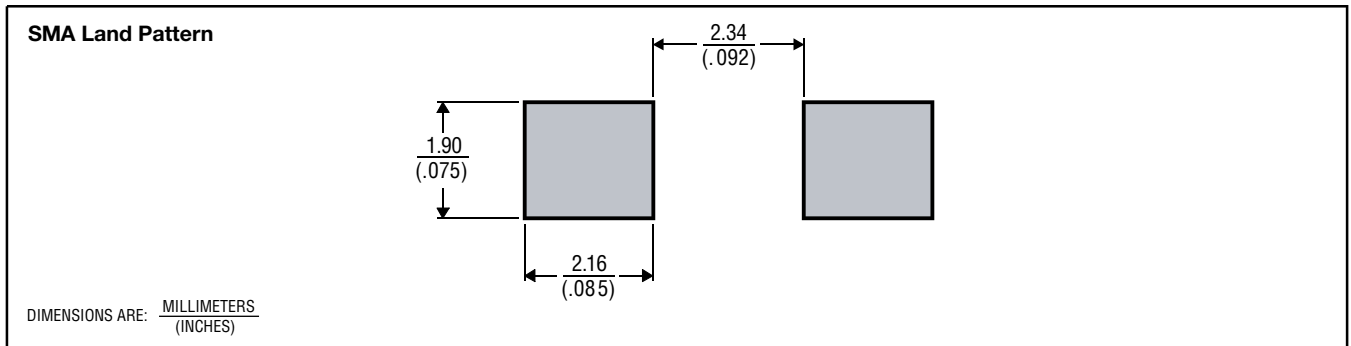

MDXXBIC

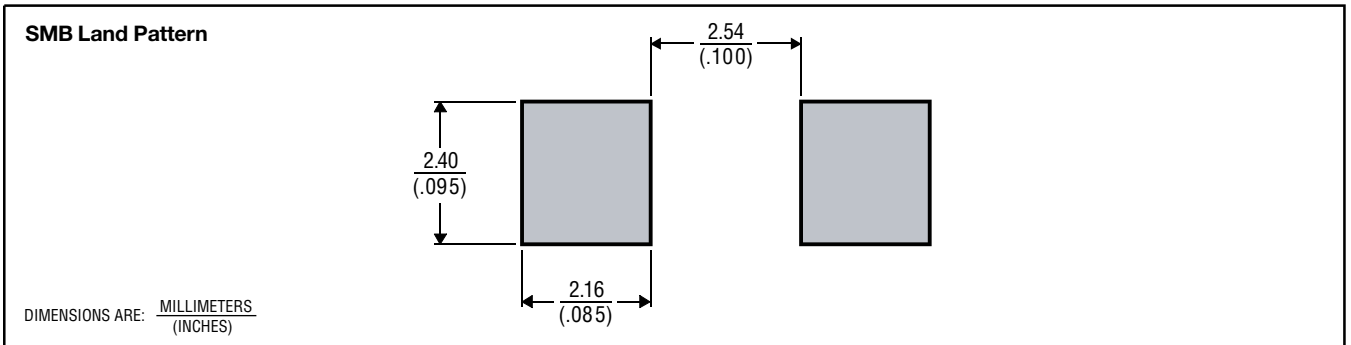

MDXXBIB

Device Symbolization Code

Devices will be coded as below. As the device parameters are symmetrical, terminal 1 is not identified.

Device	Symbolization Code	Device	Symbolization Code
TISP4015L1AJ	4015L	TISP4015L1BJ	4015L1
TISP4030L1AJ	4030L	TISP4030L1BJ	4030L1
TISP4040L1AJ	4040L	TISP4040L1BJ	4040L1

Carrier Information

For production quantities, the carrier will be embossed tape reel pack. Evaluation quantities may be shipped in bulk pack or embossed tape.

Package	Carrier	Standard Quantity
SMA	Embossed Tape Reel Pack	5000
SMB		3000

AUGUST 1999 – REVISED JULY 2019

“TISP” is a trademark of Bourns, Ltd., a Bourns Company, and is registered in the U.S. Patent and Trademark Office.

“Bourns” is a registered trademark of Bourns, Inc. in the U.S. and other countries.

Specifications are subject to change without notice.

Users should verify actual device performance in their specific applications.

The products described herein and this document are subject to specific legal disclaimers as set forth on the last page of this document, and at www.bourns.com/docs/legal/disclaimer.pdf.

This legal disclaimer applies to purchasers and users of Bourns® products manufactured by or on behalf of Bourns, Inc. and its affiliates (collectively, “Bourns”).

Unless otherwise expressly indicated in writing, Bourns® products and data sheets relating thereto are subject to change without notice. Users should check for and obtain the latest relevant information and verify that such information is current and complete before placing orders for Bourns® products.

The characteristics and parameters of a Bourns® product set forth in its data sheet are based on laboratory conditions, and statements regarding the suitability of products for certain types of applications are based on Bourns’ knowledge of typical requirements in generic applications. The characteristics and parameters of a Bourns® product in a user application may vary from the data sheet characteristics and parameters due to (i) the combination of the Bourns® product with other components in the user’s application, or (ii) the environment of the user application itself. The characteristics and parameters of a Bourns® product also can and do vary in different applications and actual performance may vary over time. Users should always verify the actual performance of the Bourns® product in their specific devices and applications, and make their own independent judgments regarding the amount of additional test margin to design into their device or application to compensate for differences between laboratory and real world conditions.

Unless Bourns has explicitly designated an individual Bourns® product as meeting the requirements of a particular industry standard (e.g., ISO/TS 16949) or a particular qualification (e.g., UL listed or recognized), Bourns is not responsible for any failure of an individual Bourns® product to meet the requirements of such industry standard or particular qualification. Users of Bourns® products are responsible for ensuring compliance with safety-related requirements and standards applicable to their devices or applications.

Bourns® products are not recommended, authorized or intended for use in nuclear, lifesaving, life-critical or life-sustaining applications, nor in any other applications where failure or malfunction may result in personal injury, death, or severe property or environmental damage. Unless expressly and specifically approved in writing by two authorized Bourns representatives on a case-by-case basis, use of any Bourns® products in such unauthorized applications might not be safe and thus is at the user’s sole risk. Life-critical applications include devices identified by the U.S. Food and Drug Administration as Class III devices and generally equivalent classifications outside of the United States.

Bourns expressly identifies those Bourns® standard products that are suitable for use in automotive applications on such products’ data sheets in the section entitled “Applications.” Unless expressly and specifically approved in writing by two authorized Bourns representatives on a case-by-case basis, use of any other Bourns® standard products in an automotive application might not be safe and thus is not recommended, authorized or intended and is at the user’s sole risk. If Bourns expressly identifies a sub-category of automotive application in the data sheet for its standard products (such as infotainment or lighting), such identification means that Bourns has reviewed its standard product and has determined that if such Bourns® standard product is considered for potential use in automotive applications, it should only be used in such sub-category of automotive applications. Any reference to Bourns® standard product in the data sheet as compliant with the AEC-Q standard or “automotive grade” does not by itself mean that Bourns has approved such product for use in an automotive application.

Bourns® standard products are not tested to comply with United States Federal Aviation Administration standards generally or any other generally equivalent governmental organization standard applicable to products designed or manufactured for use in aircraft or space applications. Bourns expressly identifies Bourns® standard products that are suitable for use in aircraft or space applications on such products’ data sheets in the section entitled “Applications.” Unless expressly and specifically approved in writing by two authorized Bourns representatives on a case-by-case basis, use of any other Bourns® standard product in an aircraft or space application might not be safe and thus is not recommended, authorized or intended and is at the user’s sole risk.

The use and level of testing applicable to Bourns® custom products shall be negotiated on a case-by-case basis by Bourns and the user for which such Bourns® custom products are specially designed. Absent a written agreement between Bourns and the user regarding the use and level of such testing, the above provisions applicable to Bourns® standard products shall also apply to such Bourns® custom products.

Users shall not sell, transfer, export or re-export any Bourns® products or technology for use in activities which involve the design, development, production, use or stockpiling of nuclear, chemical or biological weapons or missiles, nor shall they use Bourns® products or technology in any facility which engages in activities relating to such devices. The foregoing restrictions apply to all uses and applications that violate national or international prohibitions, including embargos or international regulations. Further, Bourns® products and Bourns technology and technical data may not under any circumstance be exported or re-exported to countries subject to international sanctions or embargoes. Bourns® products may not, without prior authorization from Bourns and/or the U.S. Government, be resold, transferred, or re-exported to any party not eligible to receive U.S. commodities, software, and technical data.

To the maximum extent permitted by applicable law, Bourns disclaims (i) any and all liability for special, punitive, consequential, incidental or indirect damages or lost revenues or lost profits, and (ii) any and all implied warranties, including implied warranties of fitness for particular purpose, non-infringement and merchantability.

For your convenience, copies of this Legal Disclaimer Notice with German, Spanish, Japanese, Traditional Chinese and Simplified Chinese bilingual versions are available at:

Web Page: <http://www.bourns.com/legal/disclaimers-terms-and-policies>

PDF: <http://www.bourns.com/docs/Legal/disclaimer.pdf>

Mouser Electronics

Authorized Distributor

Click to View Pricing, Inventory, Delivery & Lifecycle Information:

Bourns:

[TISP4015L1BJR-S](#) [TISP4040L1BJR-S](#) [TISP4030L1BJR-S](#) [TISP4040L1AJR-S](#) [TISP4030L1AJR-S](#)
[TISP4015L1AJR-S](#)