

## 1A Low-Voltage $\mu$ Cap LDO Regulator

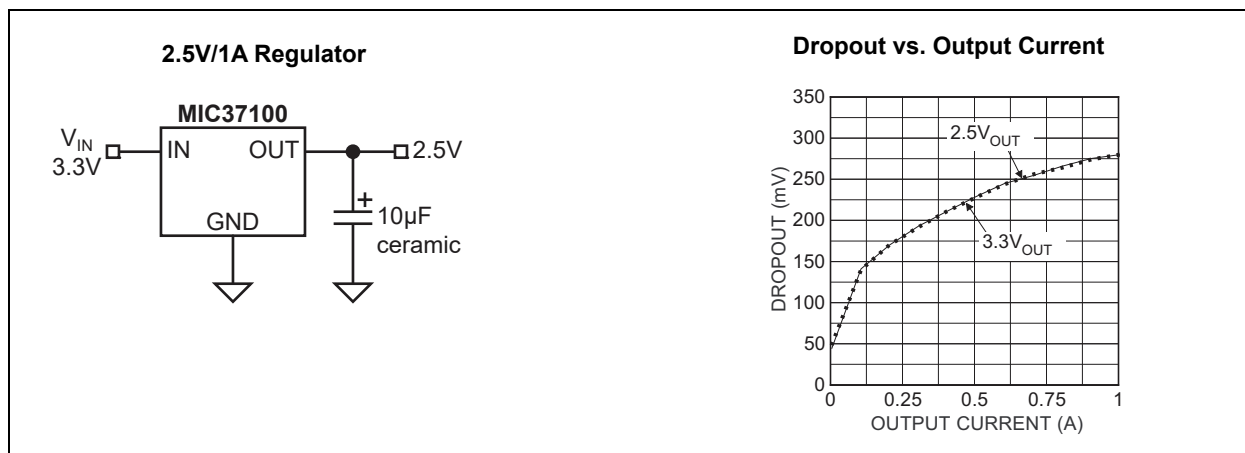
### Features

- Fixed and Adjustable Output Voltages to 1.24V
- $\mu$ Cap Regulator, 10  $\mu$ F Ceramic Output Capacitor Stable
- 280 mV Typical Dropout at 1A
  - Ideal for 3.0V to 2.5V Conversion
  - Ideal for 2.5V to 1.8V, 1.65V or 1.5V Conversion
- 1A Minimum Guaranteed Output Current
- 1% Initial Accuracy
- Low Ground Current
- Current Limiting and Thermal Shutdown
- Reversed Leakage Protection
- Fast Transient Response
- Low Profile SOT-223 Package
- Power SO-8 Package
- S-PAK Package (MIC37102 Only)

### Applications

- LDO Linear Regulator for PC Add In Cards
- PowerPC Power Supplies
- High Efficiency Linear Power Supplies
- SMPS Post Regulator
- Multimedia and PC Processor Supplies
- Battery Chargers
- Low Voltage Microcontrollers and Digital Logic

### Typical Application



### General Description

The MIC37100, MIC37101, and MIC37102 are 1A low dropout, linear voltage regulators that provide low voltage, high current output from an extremely small package. Utilizing Microchip's proprietary Super  $\beta$  PNP pass element, the MIC37100/01/02 offers extremely low dropout (typically 280 mV at 1A) and low ground current (typically 11 mA at 1A).

The MIC37100 is a fixed output regulator offered in the SOT-223 package. The MIC37101 and MIC37102 are fixed and adjustable regulators, respectively, in a thermally enhanced power 8-pin SOIC (small outline package). The MIC37102 is also available in the S-PAK power package, for applications that require higher power dissipation or higher operating ambient temperatures.

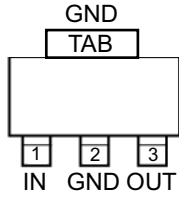
The MIC37100/01/02 is ideal for PC add in cards that need to convert from standard 5V to 3.3V, 3.3V to 2.5V or 2.5V to 1.8V or lower. A guaranteed maximum dropout voltage of 500 mV over all operating conditions allows the MIC37100/01/02 to provide 2.5V from a supply as low as 3V and 1.8V from a supply as low as 2.3V.

The MIC37100/01/02 is fully protected with overcurrent limiting and thermal shutdown. Fixed output voltages of 1.5V, 1.65V, 1.8V, 2.5V and 3.3V are available on MIC37100/01 with adjustable output voltages to 1.24V on MIC37102.

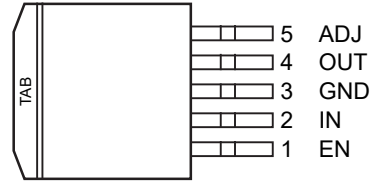
# MIC37100/01/02

## Package Types

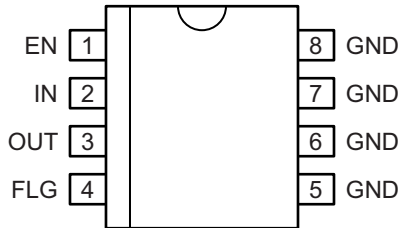
**MIC37100-x.X (FIXED)**  
**3-Pin SOT223 (S)**  
**(Top View)**



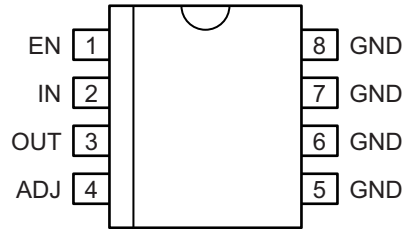
**MIC37102 (ADJUSTABLE)**  
**5-Pin S-PAK (R)**  
**(Top View)**



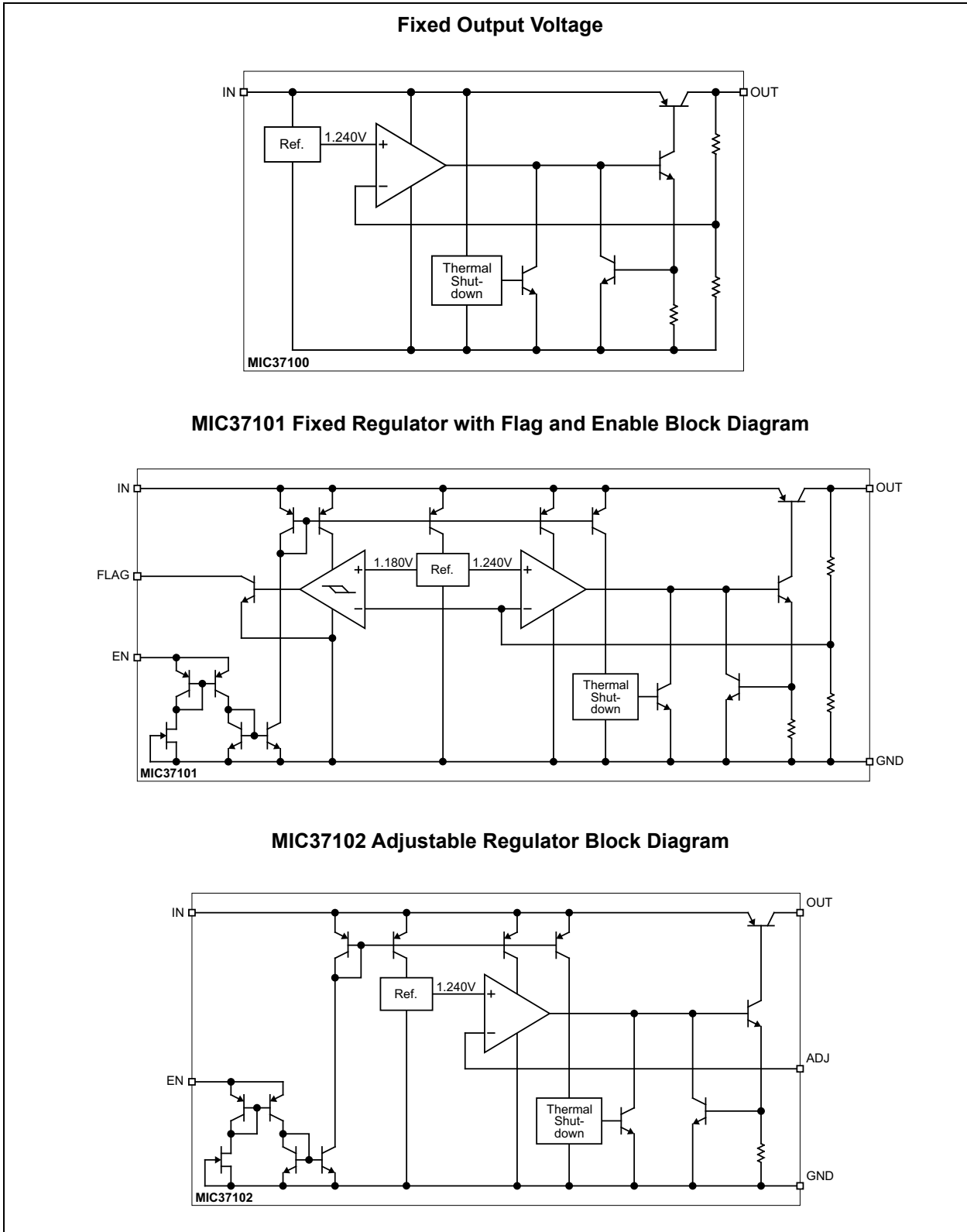
**MIC37101-x.X (FIXED)**  
**8-Pin SOIC (M)**  
**(Top View)**



**MIC37102 (ADJUSTABLE)**  
**8-Pin SOIC (M)**  
**(Top View)**



## Functional Diagrams



# MIC37100/01/02

## 1.0 ELECTRICAL CHARACTERISTICS

### Absolute Maximum Ratings †

Supply Voltage ( $V_{IN}$ ).....	0V to +6.5V
Enable Voltage ( $V_{EN}$ ).....	+6.5V
Power Dissipation ( $P_{DIS}$ ).....	Internally Limited
ESD Rating (Note 1).....	ESD Sensitive

### Operating Ratings ‡

Supply Voltage ( $V_{IN}$ ).....	+2.25V to +6V
Enable Voltage ( $V_{EN}$ ).....	0V to +6V
Maximum Power Dissipation ( $P_{D(max)}$ ).....	(Note 2)

† **Notice:** Stresses above those listed under “Absolute Maximum Ratings” may cause permanent damage to the device. This is a stress rating only and functional operation of the device at those or any other conditions above those indicated in the operational sections of this specification is not intended. Exposure to maximum rating conditions for extended periods may affect device reliability. Specifications are for packaged product only.

‡ **Notice:** The device is not guaranteed to function outside its operating ratings.

**Note 1:** Devices are ESD sensitive. Handling precautions are recommended. Human body model, 1.5 k $\Omega$  in series with 100 pF.

**2:**  $P_{D(max)} = (T_{J(max)} - T_A) \div \theta_{JA}$ , where  $\theta_{JA}$  depends upon the printed circuit layout. See “Section 4.0 “Application Information” section.

## ELECTRICAL CHARACTERISTICS

**Electrical Characteristics:**  $V_{IN} = V_{OUT} + 1V$ ;  $V_{EN} = 2.25V$ ;  $T_J = 25^\circ C$ , **Bold** values indicate  $-40^\circ C \leq T_J \leq +125^\circ C$ ; unless otherwise specified.

Parameter	Symbol	Min.	Typ.	Max.	Units	Conditions
Output Voltage	$V_{OUT}$	-1	—	1	%	10 mA
		-2		2	%	$10\text{ mA} \leq I_{OUT} \leq 1A$ , $V_{OUT} + 1V \leq V_{IN} \leq 6V$
Line Regulation	$V_{OUT}$	—	0.06	0.5	%	$I_{OUT} = 10\text{ mA}$ , $V_{OUT} + 1V \leq V_{IN} \leq 6V$
Load Regulation		—	0.2	1	%	$V_{IN} = V_{OUT} + 1V$ , $10\text{ mA} \leq I_{OUT} \leq 1A$
Output Voltage Temperature Coefficient (Note 1)	$\Delta V_{OUT}/\Delta T$	—	40	—	pm/ $^\circ C$	
Dropout Voltage (Note 2)	$V_{DO}$	—	125	<b>200</b>	mV	$I_{OUT} = 100\text{ mA}$ , $\Delta V_{OUT} = -2\%$
		—	210	<b>350</b>	mV	$I_{OUT} = 500\text{ mA}$ , $\Delta V_{OUT} = -2\%$
		—	250	<b>400</b>	mV	$I_{OUT} = 750\text{ mA}$ , $\Delta V_{OUT} = -2\%$
		—	280	<b>500</b>	mV	$I_{OUT} = 1A$ , $\Delta V_{OUT} = -1\%$
Ground Current (Note 3)	$I_{GND}$	—	650	—	$\mu A$	$I_{OUT} = 100\text{ mA}$ , $V_{IN} = V_{OUT} + 1V$
		—	3.5	—	mA	$I_{OUT} = 500\text{ mA}$ , $V_{IN} = V_{OUT} + 1V$
		—	6.7	—	mA	$I_{OUT} = 750\text{ mA}$ , $V_{IN} = V_{OUT} + 1V$
		—	11	<b>25</b>	mA	$I_{OUT} = 1A$ , $V_{IN} = V_{OUT} + 1V$
Current Limit	$I_{OUT(lim)}$	—	1.6	2.5	A	$V_{OUT} = 0V$ , $V_{IN} = V_{OUT} + 1V$

## ELECTRICAL CHARACTERISTICS (CONTINUED)

**Electrical Characteristics:**  $V_{IN} = V_{OUT} + 1V$ ;  $V_{EN} = 2.25V$ ;  $T_J = 25^\circ C$ , **Bold** values indicate  $-40^\circ C \leq T_J \leq +125^\circ C$ ; unless otherwise specified.

Parameter	Symbol	Min.	Typ.	Max.	Units	Conditions
<b>Enable Input</b>						
Enable Input Voltage	$V_{EN}$	—	—	<b>0.8</b>	V	Logic low (OFF)
		<b>2.25</b>	—	—	V	Logic high (ON)
Enable Input Current	$I_{EN}$	1	10	<b>30</b>	$\mu A$	$V_{EN} = 2.25V$
		—	—	2	$\mu A$	$V_{EN} = 0.8V$
		—	—	<b>4</b>	$\mu A$	
<b>Flag Output</b>						
Output Leakage Current	$I_{FLG(leak)}$	—	0.01	1	$\mu A$	$V_{OH} = 6V$
		—	—	<b>2</b>		
Output Low Voltage	$V_{FLG(do)}$	—	210	<b>500</b>	mV	$V_{IN} = 2.25V$ , $I_{OL} = 250 \mu A$
Low Threshold	$V_{FLG}$	93	—	—	%	% of $V_{OUT}$
High Threshold		—	—	99.2	%	% of $V_{OUT}$
Hysteresis		—	1	—	%	—
<b>MIC37102 Only</b>						
Reference Voltage	—	1.228	1.240	1.252	V	—
	—	<b>1.215</b>	—	<b>1.265</b>	V	—
Adjust Pin Bias Current	—	—	40	80	nA	—
	—	—	—	<b>120</b>	nA	—

- 1: Output voltage temperature coefficient is  $\Delta V_{OUT}(\text{worst case}) \div (T_{J(\text{max})} - T_{J(\text{min})})$  where  $T_{J(\text{max})}$  is  $+125^\circ C$  and  $T_{J(\text{min})}$  is  $-40^\circ C$ .
- 2:  $V_{DO} = V_{IN} - V_{OUT}$  when  $V_{OUT}$  decreases to 98% of its nominal output voltage with  $V_{IN} = V_{OUT} + 1V$ . For output voltages below 2.25V, dropout voltage is the input-to-output voltage differential with the minimum input voltage being 2.25V. Minimum input operating voltage is 2.25V.
- 3:  $I_{GND}$  is the quiescent current.  $I_{IN} = I_{GND} + I_{OUT}$ .

# MIC37100/01/02

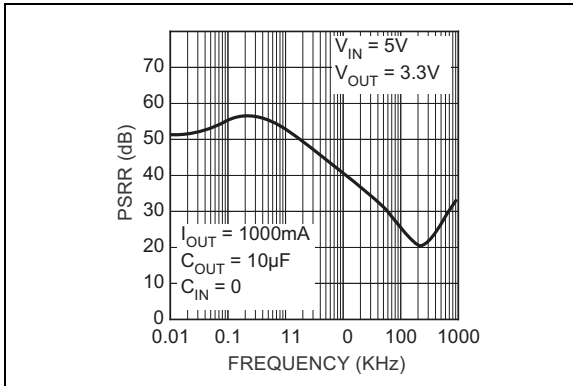
## TEMPERATURE SPECIFICATIONS (Note 1)

Parameters	Sym.	Min.	Typ.	Max.	Units	Conditions
<b>Temperature Ranges</b>						
Lead Temperature (soldering, 5 sec.)	—	—	—	260	°C	—
Junction Operating Temperature Range	$T_J$	-40	—	+125	°C	—
Storage Temperature Range	$T_S$	-65	—	+150	°C	—
<b>Package Thermal Resistances</b>						
Thermal Resistance SOT-223	$\theta_{JC}$	—	15	—	°C/W	—
Thermal Resistance SOIC-8	$\theta_{JC}$	—	20	—	°C/W	—
Thermal Resistance SPAK-5	$\theta_{JC}$	—	2	—	°C/W	—

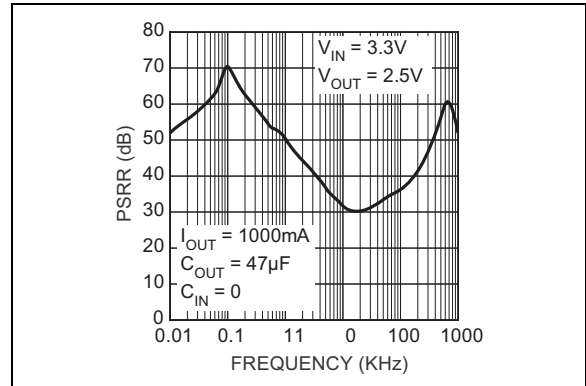
**Note 1:** The maximum allowable power dissipation is a function of ambient temperature, the maximum allowable junction temperature and the thermal resistance from junction to air (i.e.,  $T_A$ ,  $T_J$ ,  $\theta_{JA}$ ). Exceeding the maximum allowable power dissipation will cause the device operating junction temperature to exceed the maximum +125°C rating. Sustained junction temperatures above +125°C can impact the device reliability.

## 2.0 TYPICAL PERFORMANCE CURVES

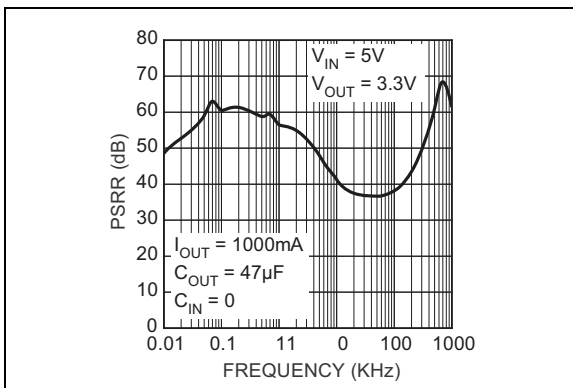
**Note:** The graphs and tables provided following this note are a statistical summary based on a limited number of samples and are provided for informational purposes only. The performance characteristics listed herein are not tested or guaranteed. In some graphs or tables, the data presented may be outside the specified operating range (e.g., outside specified power supply range) and therefore outside the warranted range.



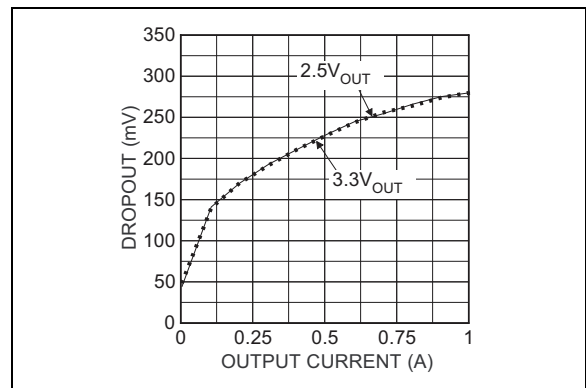
**FIGURE 2-1:** Power Supply Rejection Ratio.



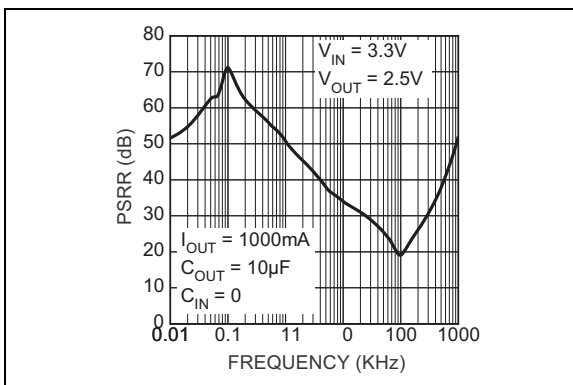
**FIGURE 2-4:** Power Supply Rejection Ratio.



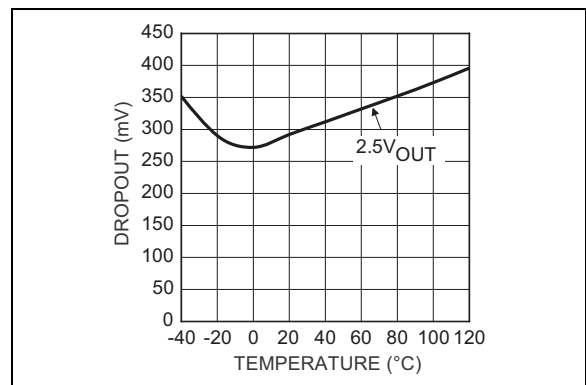
**FIGURE 2-2:** Power Supply Rejection Ratio.



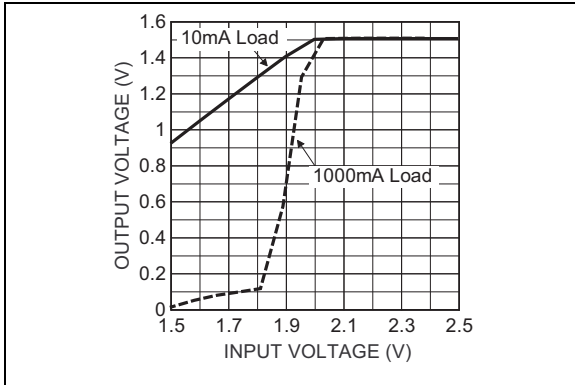
**FIGURE 2-5:** Dropout vs. Output Current.



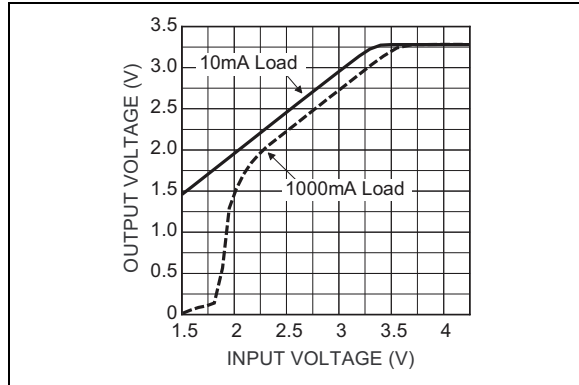
**FIGURE 2-3:** Power Supply Rejection Ratio.



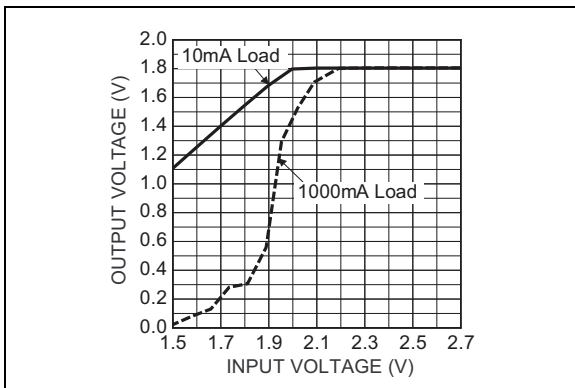
**FIGURE 2-6:** Dropout vs. Temperature.



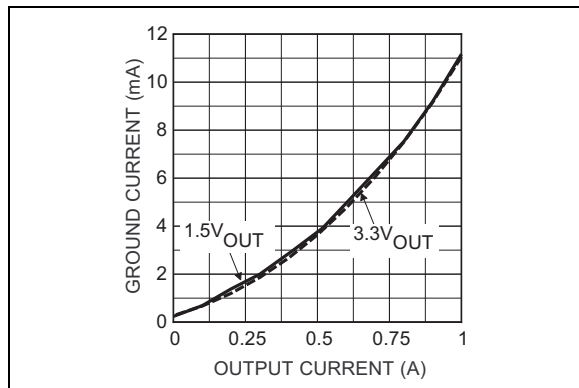
**FIGURE 2-7:** Dropout Characteristics (1.5V).



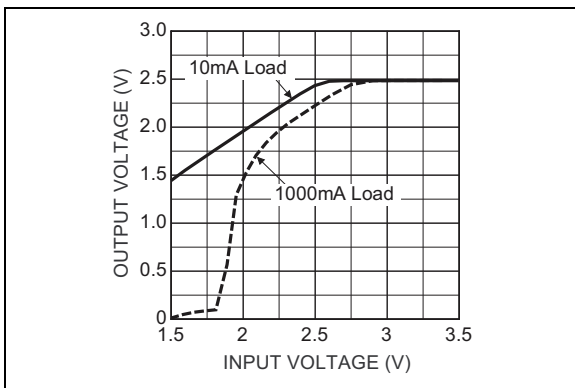
**FIGURE 2-10:** Dropout Characteristics (3.3V).



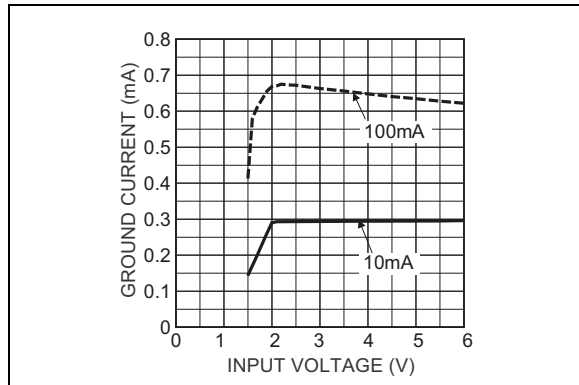
**FIGURE 2-8:** Dropout Characteristics (1.8V).



**FIGURE 2-11:** Ground Current vs. Output Current.

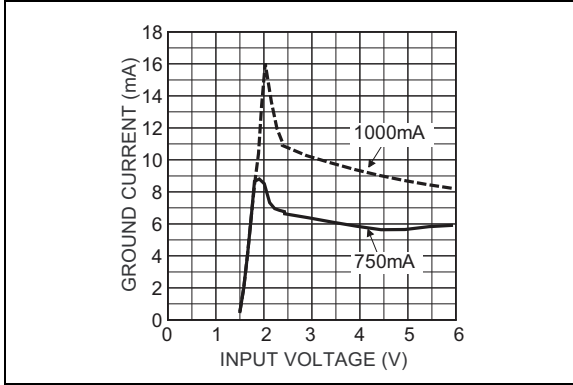


**FIGURE 2-9:** Dropout Characteristics (2.5V).

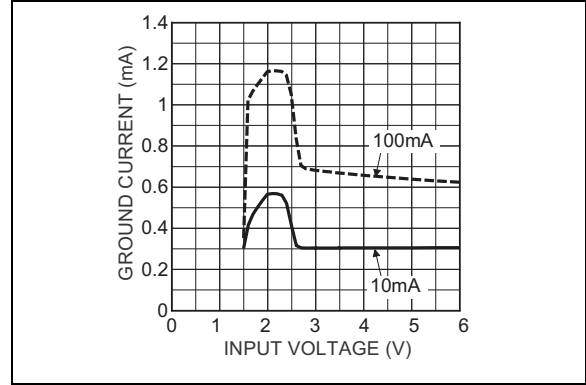


**FIGURE 2-12:** Ground Current vs. Supply Voltage (1.5V).

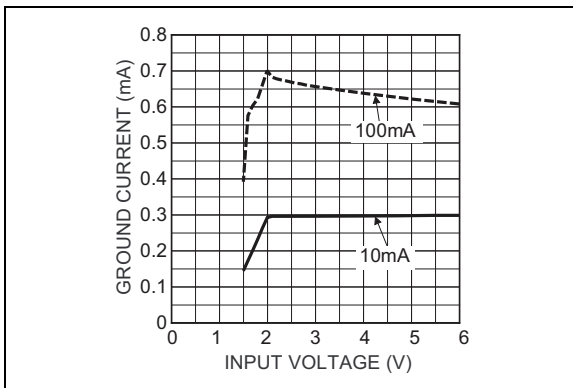




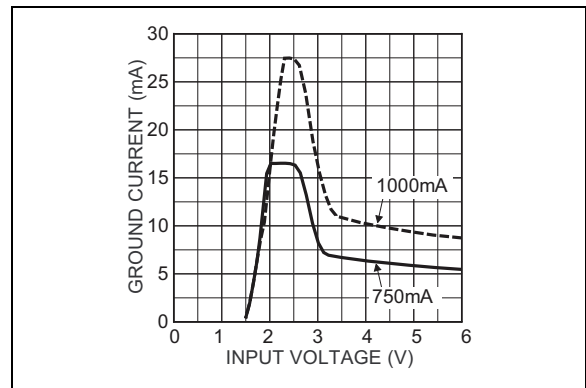
**FIGURE 2-13:** Ground Current vs. Supply Voltage (1.5V).



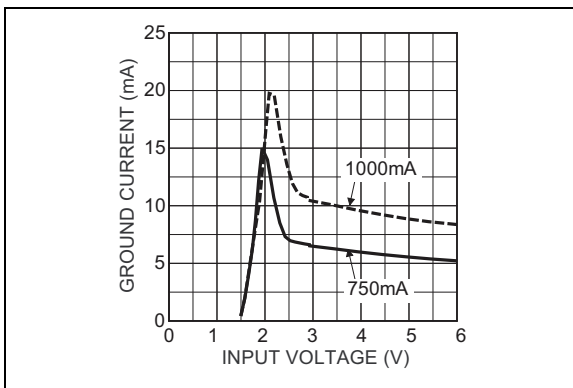
**FIGURE 2-16:** Ground Current vs. Supply Voltage (2.5V).



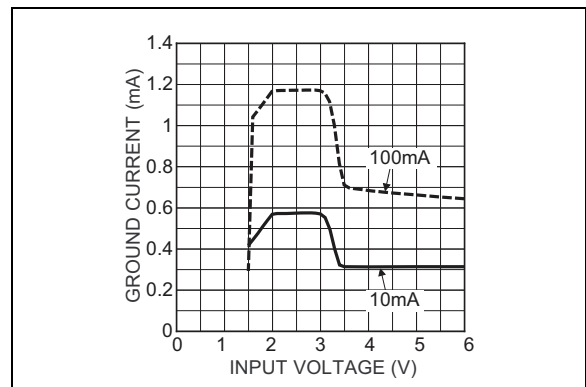
**FIGURE 2-14:** Ground Current vs. Supply Voltage (1.8V).



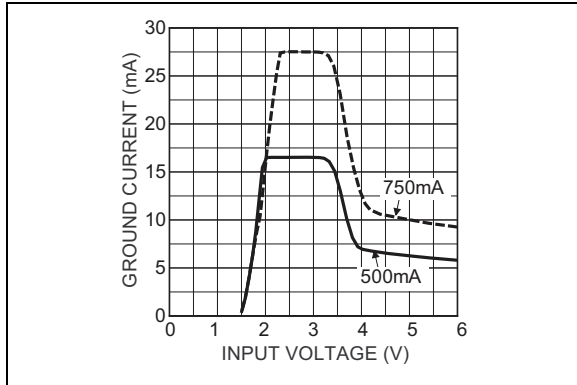
**FIGURE 2-17:** Ground Current vs. Supply Voltage (2.5V).



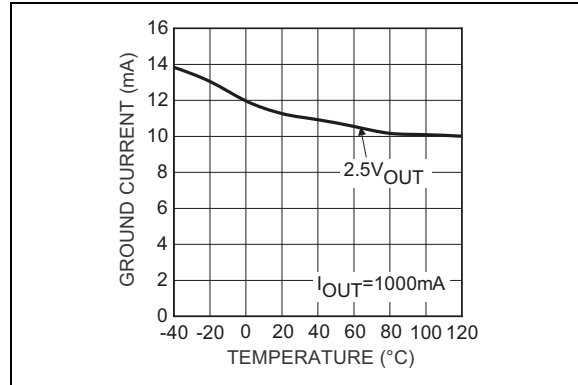
**FIGURE 2-15:** Ground Current vs. Supply Voltage (1.8V).



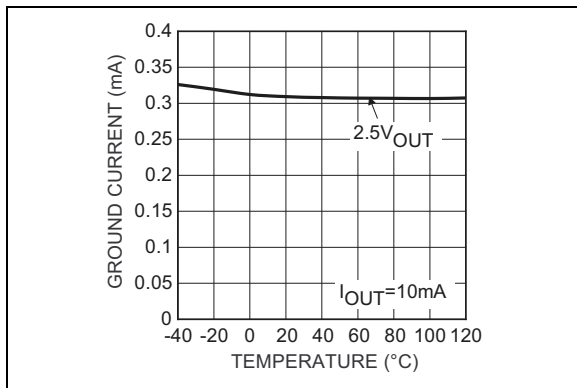
**FIGURE 2-18:** Ground Current vs. Supply Voltage (3.3V).



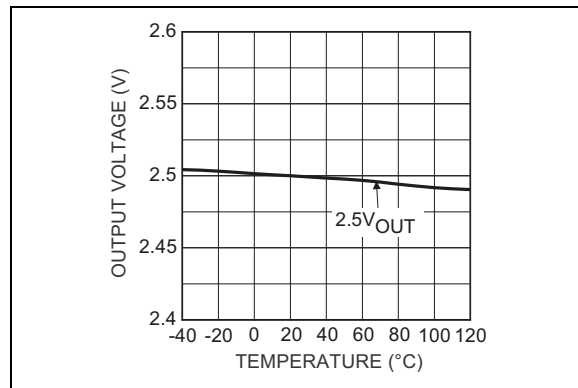
**FIGURE 2-19:** Ground Current vs. Supply Voltage (3.3V).



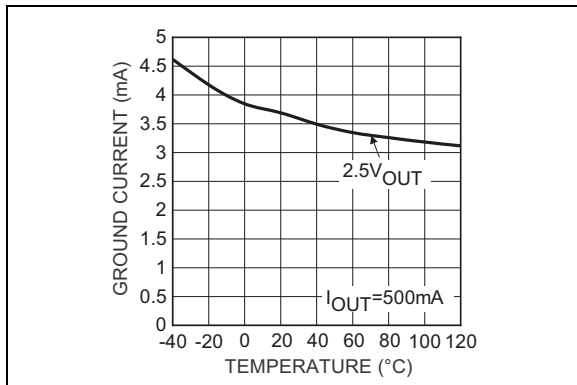
**FIGURE 2-22:** Ground Current vs. Temperature.



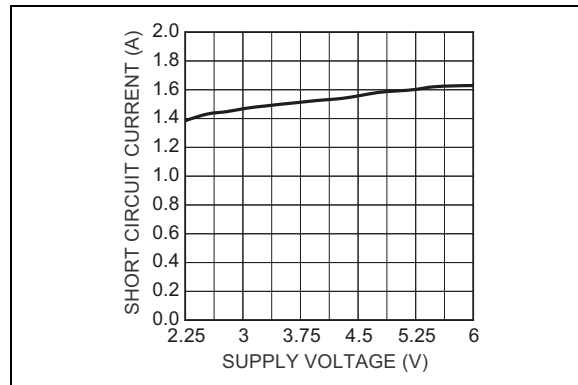
**FIGURE 2-20:** Ground Current vs. Temperature.



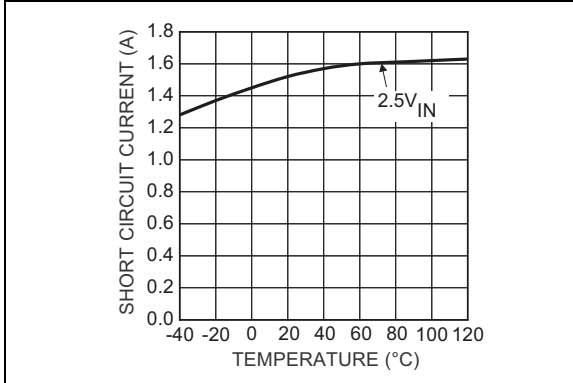
**FIGURE 2-23:** Output Voltage vs. Temperature.



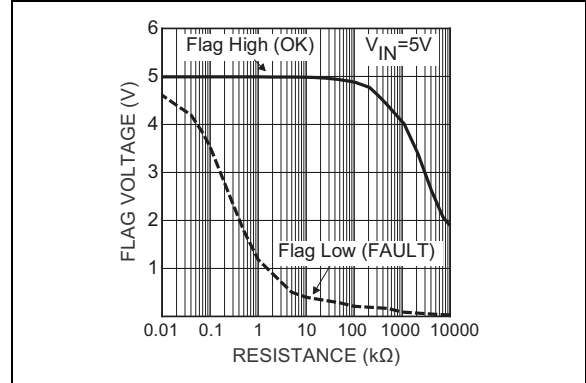
**FIGURE 2-21:** Ground Current vs. Temperature.



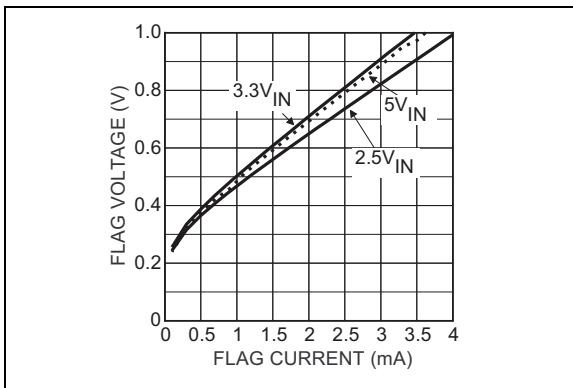
**FIGURE 2-24:** Short Circuit Current vs. Supply Voltage.



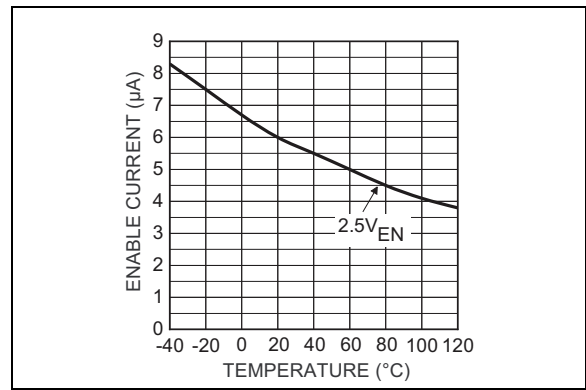
**FIGURE 2-25:** Short Circuit Current vs. Temperature.



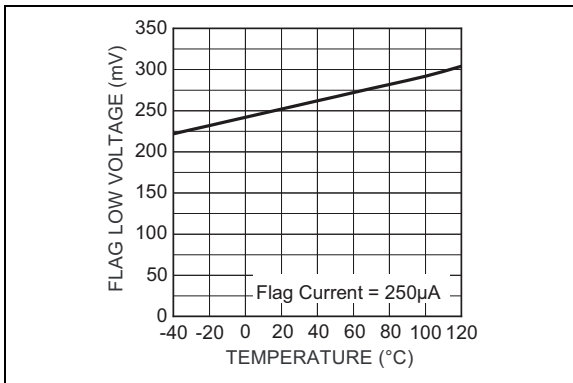
**FIGURE 2-28:** Error Flag Pull-Up Resistor.



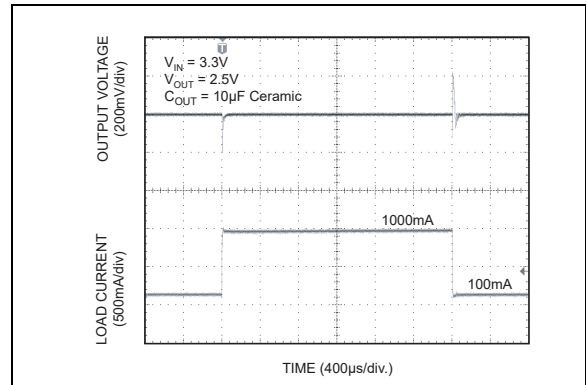
**FIGURE 2-26:** Flag Voltage vs. Flag Current.



**FIGURE 2-29:** Enable Current vs. Temperature.

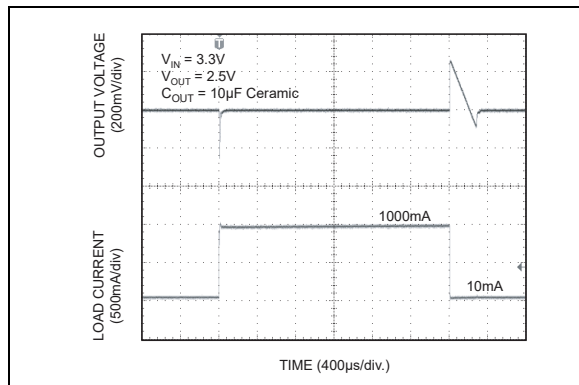


**FIGURE 2-27:** Flag Low Voltage vs. Temperature.

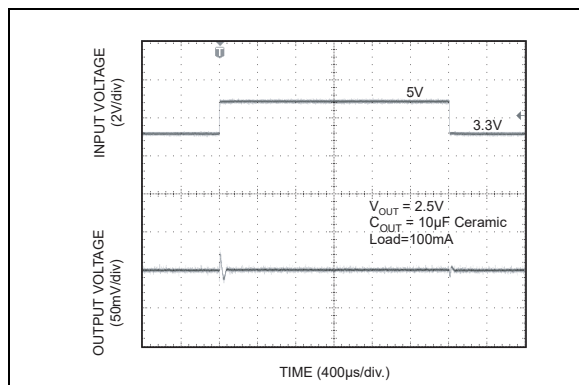


**FIGURE 2-30:** Load Transient Response.

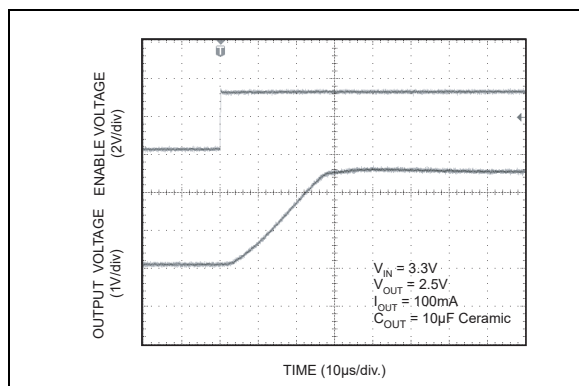
# MIC37100/01/02



**FIGURE 2-31:** Load Transient Response.



**FIGURE 2-32:** Line Transient Response.



**FIGURE 2-33:** Enable Transient Response.

## 3.0 PIN DESCRIPTIONS

The descriptions of the pins are listed in [Table 3-1](#).

**TABLE 3-1: PIN FUNCTION TABLE**

Pin Number MIC37100 SOT223-3	Pin Number MIC37101 SOIC-8	Pin Number MIC37102 SOIC-8	Pin Number MIC37102 S-PAK-5	Pin Name	Description
—	1	1	1	EN	Enable (Input): CMOS compatible control input. Logic high = enable, Logic low or open = shutdown.
1	2	2	2	IN	Supply (Input).
3	3	3	4	OUT	Regulator output.
—	4	—	—	FLG	Flag (Output): Open collector error flag output. Active low = output under voltage.
—	—	4	5	ADJ	Adjustment Input: Feedback input. Connect to resistive voltage divider network.
2, TAB	5-8	5-8	3, TAB	GND	Ground.

# MIC37100/01/02

## 4.0 APPLICATION INFORMATION

The MIC37100/01/02 is a high-performance low dropout voltage regulator suitable for moderate to high current voltage regulator applications. Its 500 mV dropout voltage at full load and overtemperature makes it especially valuable in battery powered systems and as high efficiency noise filters in post regulator applications. Unlike older NPN-pass transistor designs, where the minimum dropout voltage is limited by the base-to-emitter voltage drop and collector-to-emitter saturation voltage, dropout performance of the PNP output of these devices is limited only by the low VCE saturation voltage.

A trade-off for the low dropout voltage is a varying base drive requirement. Microchip's Super  $\beta$  PNP process reduces this drive requirement to only 2% of the load current.

The MIC37100/01/02 regulator is fully protected from damage due to fault conditions. Linear current limiting is provided. Output current during overload conditions is constant. Thermal shutdown disables the device when the die temperature exceeds the maximum safe operating temperature. The output structure of these regulators allows voltages in excess of the desired output voltage to be applied without reverse current flow.

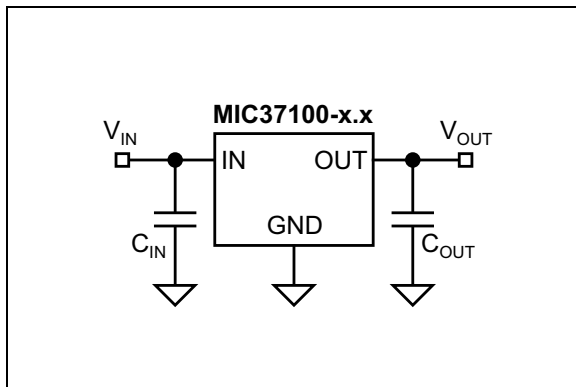


FIGURE 4-1: Capacitor Requirements.

### 4.1 Output Capacitor

The MIC37100/01/02 requires an output capacitor to maintain stability and improve transient response. As a  $\mu$ Cap LDO, the MIC37100/01/02 can operate with ceramic output capacitors as long as the amount of capacitance is 10  $\mu$ F or greater. For values of output capacitance lower than 10  $\mu$ F, the recommended ESR range is 200 m $\Omega$  to 2 $\Omega$ . The minimum value of output capacitance recommended for the MIC37100/01/02 is 4.7  $\mu$ F.

For 10  $\mu$ F or greater the ESR range recommended is less than 1 $\Omega$ . Ultra-low ESR ceramic capacitors are recommended for output capacitance of 10  $\mu$ F or greater to help improve transient response and noise

reduction at high frequency. X7R/X5R dielectric-type ceramic capacitors are recommended because of their temperature performance. X7R-type capacitors change capacitance by 15% over their operating temperature range and are the most stable type of ceramic capacitors. Z5U and Y5V dielectric capacitors change value by as much as 50% and 60% respectively over their operating temperature ranges. To use a ceramic chip capacitor with Y5V dielectric, the value must be much higher than an X7R ceramic capacitor to ensure the same minimum capacitance over the equivalent operating temperature range.

### 4.2 Input Capacitor

An input capacitor of 1  $\mu$ F or greater is recommended when the device is more than 4 inches away from the bulk ac supply capacitance or when the supply is a battery. Small, surface mount, ceramic chip capacitors can be used for bypassing. Larger values will help to improve ripple rejection by bypassing the input to the regulator, further improving the integrity of the output voltage.

### 4.3 Error Flag

The MIC37101 features an error flag (FLG), which monitors the output voltage and signals an error condition when this voltage drops 5% below its expected value. The error flag is an open-collector output that pulls low under fault conditions and may sink up to 10 mA. Low output voltage signifies a number of possible problems, including an overcurrent fault (the device is in current limit) or low input voltage. The flag output is inoperative during overtemperature conditions. A pull-up resistor from FLG to either  $V_{IN}$  or  $V_{OUT}$  is required for proper operation. For information regarding the minimum and maximum values of pull-up resistance, refer to FIGURE 2-28: "Error Flag Pull-Up Resistor." in the 2.0 "Typical Performance Curves" section of the data sheet.

### 4.4 Enable Input

The MIC37101 and MIC37102 versions feature an active-high enable input (EN) that allows on-off control of the regulator. Current drain reduces to "zero" when the device is shutdown, with only microamperes of leakage current. The EN input has TTL/CMOS compatible thresholds for simple logic interfacing. EN may be directly tied to  $V_{IN}$  and pulled up to the maximum supply voltage.

### 4.5 Transient Response and 3.3V to 2.5V or 2.5V to 1.8V, 1.65V or 1.5V Conversion

The MIC37100/01/02 has excellent transient response to variations in input voltage and load current. The device has been designed to respond quickly to load

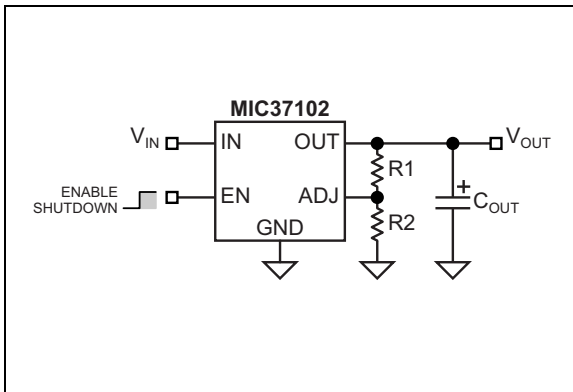
current variations and input voltage variations. Large output capacitors are not required to obtain this performance. A standard 10  $\mu\text{F}$  output capacitor, is all that is required. Larger values help to improve performance even further.

By virtue of its low dropout voltage, this device does not saturate into dropout as readily as similar NPN-based designs. When converting from 3.3V to 2.5V or 2.5V to 1.8V, or lower, the NPN based regulators are already operating in dropout, with typical dropout requirements of 1.2V or greater. To convert down to 2.5V or 1.8V without operating in dropout, NPN-based regulators require an input voltage of 3.7V at the very least. The MIC37100 regulator will provide excellent performance with an input as low as 3.0V or 2.5V respectively. This gives the PNP based regulators a distinct advantage over older, NPN based linear regulators.

## 4.6 Minimum Load Current

The MIC37100/01/02 regulator is specified between finite loads. If the output current is too small, leakage currents dominate and the output voltage rises. A 10 mA minimum load current is necessary for proper regulation.

## 4.7 Adjustable Regulator Design



**FIGURE 4-2:** Adjustable Regulator with Resistors.

### EQUATION 4-1:

$$V_{OUT} = 1.240V \left( 1 + \frac{R1}{R2} \right)$$

The MIC37102 allows programming the output voltage anywhere between 1.24V and the 6V maximum operating rating of the family. Two resistors are used. Resistors can be quite large, up to 1 M $\Omega$ , because of

the very high input impedance and low bias current of the sense comparator. The resistor values are calculated by:

### EQUATION 4-2:

$$R1 = R2 \left( \frac{V_{OUT}}{1.240} - 1 \right)$$

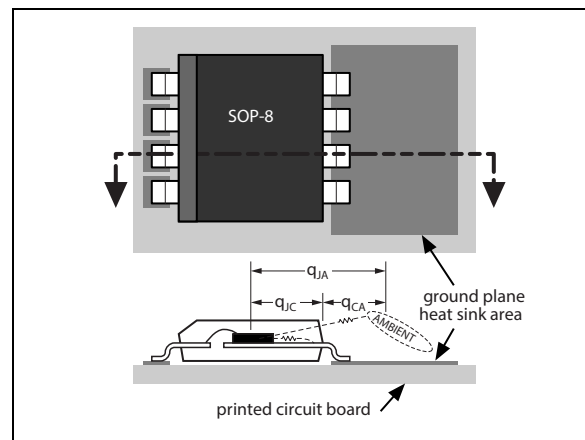
Where  $V_{OUT}$  is the desired output voltage. Figure 4-2 shows the component definition. Applications with widely varying load currents may scale the resistors to draw the minimum load current required for proper operation.

## 4.8 Power SOIC-8 Thermal Characteristics

One of the secrets of the MIC37101/02's performance is its power SO-8 package featuring half the thermal resistance of a standard SO-8 package. Lower thermal resistance means more output current or higher input voltage for a given package size.

Lower thermal resistance is achieved by joining the four ground leads with the die attach paddle to create a single piece electrical and thermal conductor. This concept has been used by MOSFET manufacturers for years, proving very reliable and cost effective for the user.

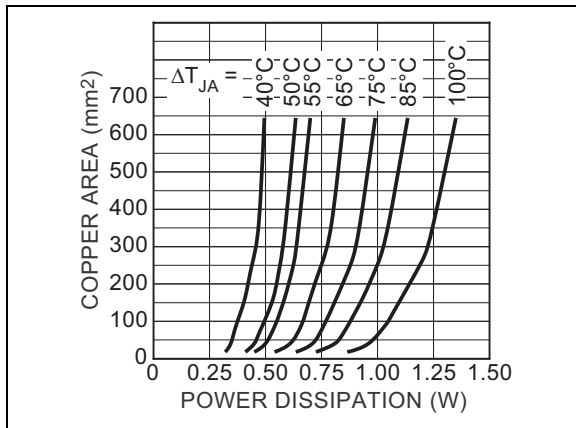
Thermal resistance consists of two main elements,  $\theta_{JC}$  (junction-to-case thermal resistance) and  $\theta_{CA}$  (case-to-ambient thermal resistance). See Figure 4-3.  $\theta_{JC}$  is the resistance from the die to the leads of the package.  $\theta_{CA}$  is the resistance from the leads to the ambient air and it includes  $\theta_{CS}$  (case-to-sink thermal resistance) and  $\theta_{SA}$  (sink-to-ambient thermal resistance).



**FIGURE 4-3:** Thermal Resistance.

Using the power SOIC-8 reduces the  $\theta_{JC}$  dramatically and allows the user to reduce  $\theta_{CA}$ . The total thermal resistance,  $\theta_{JA}$  (junction-to-ambient thermal resistance) is the limiting factor in calculating the maximum power dissipation capability of the device. Typically, the power SOIC-8 has a  $\theta_{JC}$  of 20°C/W, this is significantly lower than the standard SOIC-8 which is typically 75°C/W.  $\theta_{CA}$  is reduced because pins 5 through 8 can now be soldered directly to a ground plane which significantly reduces the case-to-sink thermal resistance and sink to ambient thermal resistance.

Low dropout linear regulators from Microchip are rated to a maximum junction temperature of 125°C. It is important not to exceed this maximum junction temperature during operation of the device. To prevent this maximum junction temperature from being exceeded, the appropriate ground plane heat sink must be used.



**FIGURE 4-4:** Copper Area vs. Power SO-8 Power Dissipation.

Figure 4-4 shows copper area versus power dissipation with each trace corresponding to a different temperature rise above ambient.

From these curves, the minimum area of copper necessary for the part to operate safely can be determined. The maximum allowable temperature rise must be calculated to determine operation along which curve.

**EQUATION 4-3:**

$$\Delta T = T_{J(max)} - T_{A(max)}$$

Where:

$T_{J(max)} = 125^{\circ}\text{C}$

$T_{A(max)} =$  maximum ambient operating temperature

For example, the maximum ambient temperature is 50°C, the  $\Delta T$  is determined as follows:

**EQUATION 4-4:**

$$\Delta T = 125^{\circ}\text{C} - 50^{\circ}\text{C}$$

$$\Delta T = 75^{\circ}\text{C}$$

Using Figure 4-4, the minimum amount of required copper can be determined based on the required power dissipation. Power dissipation in a linear regulator is calculated as follows:

**EQUATION 4-5:**

$$P_D = (V_{IN} - V_{OUT})I_{OUT} + V_{IN} \times I_{GND}$$

If we use a 2.5V output device and a 3.3V input at an output current of 1A, then our power dissipation is as follows:

**EQUATION 4-6:**

$$P_D = (3.3\text{V} - 2.5\text{V}) \times 1\text{A} + 3.3\text{V} \times 11\text{mA}$$

$$P_D = 800\text{mV} + 36\text{mV}$$

$$P_D = 836\text{mW}$$

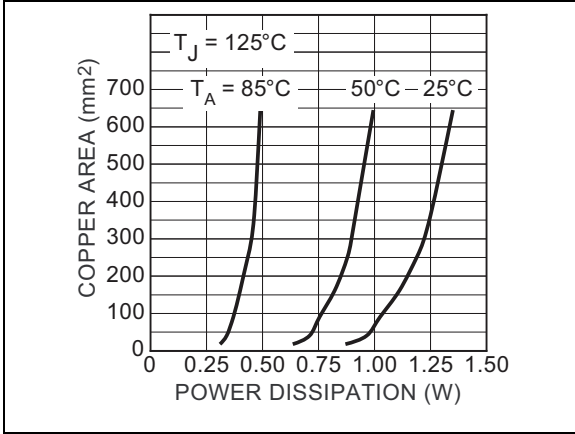
From Figure 4-4, the minimum amount of copper required to operate this application at a  $\Delta T$  of 75°C is 160 mm<sup>2</sup>.

## 4.9 Quick Method

Determine the power dissipation requirements for the design along with the maximum ambient temperature at which the device will be operated. Refer to Figure 4-5, which shows safe operating curves for three different ambient temperatures: 25°C, 50°C and 85°C. From these curves, the minimum amount of copper can be determined by knowing the maximum power dissipation required. If the maximum ambient temperature is 50°C and the power dissipation is as above, 836 mW, the curve in Figure 4-5 shows that the required area of copper is 160 mm<sup>2</sup>.

The  $\theta_{JA}$  of this package is ideally 63°C/W, but it will vary depending upon the availability of copper ground plane to which it is attached.





**FIGURE 4-5:** Copper Area vs. Power-SOIC Power Dissipation.

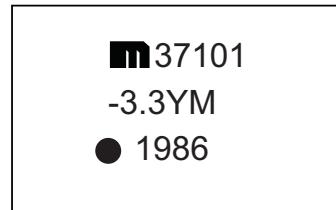
## 5.0 PACKAGING INFORMATION

### 5.1 Package Marking Information

8-Pin SOIC\*



Example



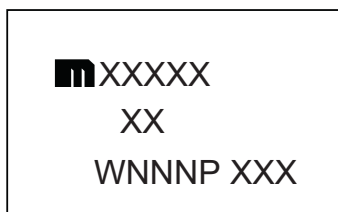
3-Pin SOT223\*



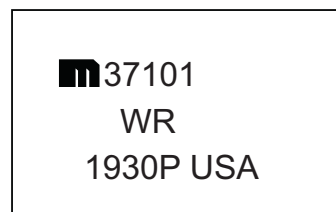
Example



5-Pin S-PAK\*



Example



<b>Legend:</b>	XX...X	Product code or customer-specific information
	Y	Year code (last digit of calendar year)
	YY	Year code (last 2 digits of calendar year)
	WW	Week code (week of January 1 is week '01')
	NNN	Alphanumeric traceability code
	(e3)	Pb-free JEDEC® designator for Matte Tin (Sn)
	*	This package is Pb-free. The Pb-free JEDEC designator ((e3)) can be found on the outer packaging for this package.
	●, ▲, ▼	Pin one index is identified by a dot, delta up, or delta down (triangle mark).

**Note:** In the event the full Microchip part number cannot be marked on one line, it will be carried over to the next line, thus limiting the number of available characters for customer-specific information. Package may or may not include the corporate logo.

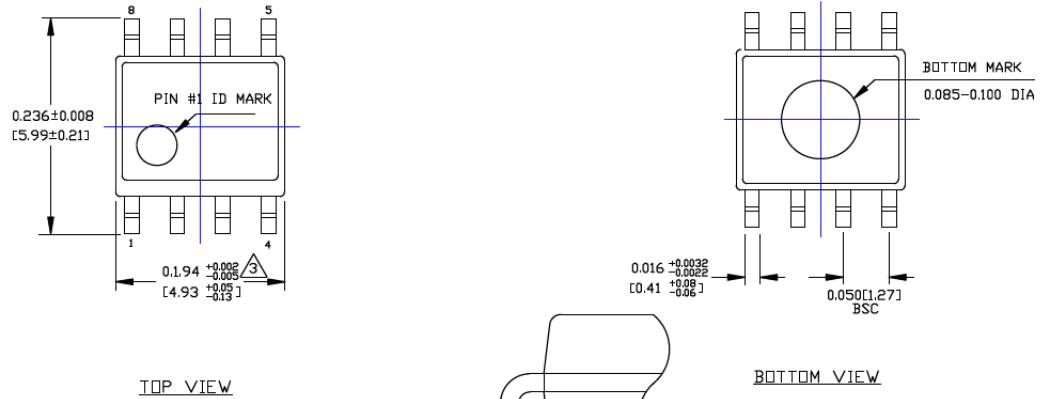
Underbar ( \_ ) and/or Overbar ( ¯ ) symbol may not be to scale.

## 8-Lead SOIC-8 Package Outline and Recommended Land Pattern

**TITLE**

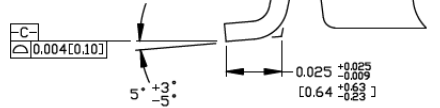
8 LEAD SOICN PACKAGE OUTLINE & RECOMMENDED LAND PATTERN

DRAWING #	SOICN-8LD-PL-1	UNIT	INCH [MM]
-----------	----------------	------	-----------

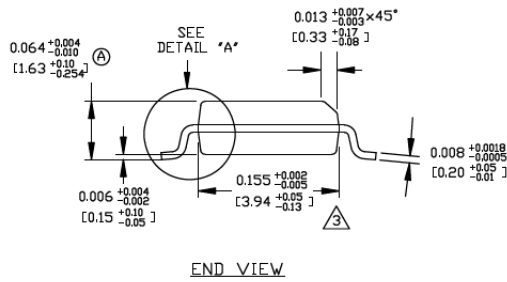


TOP VIEW

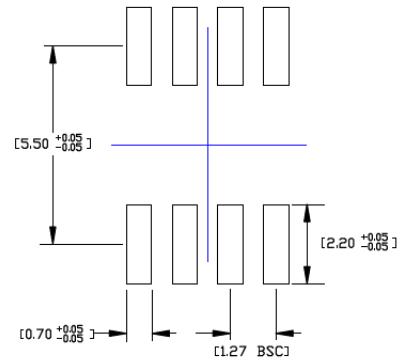
BOTTOM VIEW



DETAIL "A"



END VIEW



RECOMMENDED LAND PATTERN

**NOTES:**

1. DIMENSIONS ARE IN INCHES[MM].
2. CONTROLLING DIMENSION: INCHES.
3. DIMENSION DOES NOT INCLUDE MOLD FLASH OR PROTRUSIONS, EITHER OF WHICH SHALL NOT EXCEED 0.010[0.25] PER SIDE.

Note: For the most current package drawings, please see the Microchip Packaging Specification located at <http://www.microchip.com/packaging>.

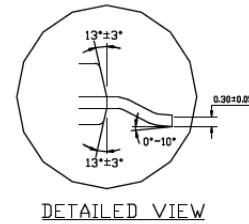
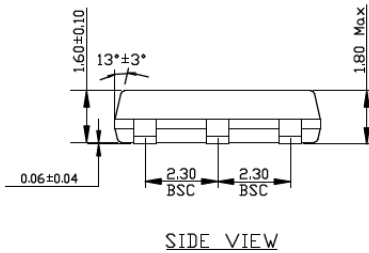
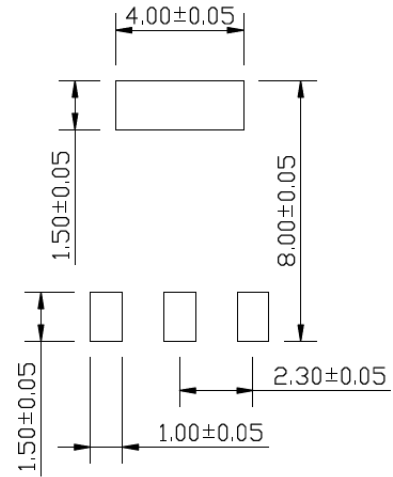
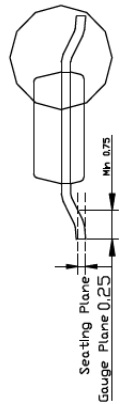
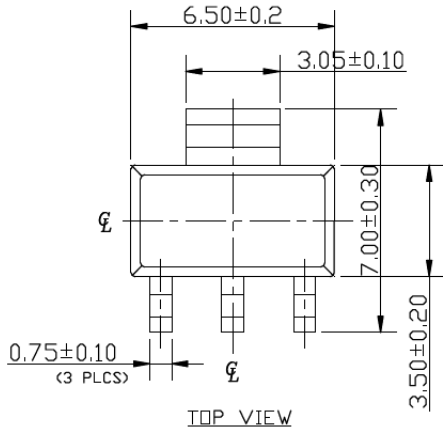
# MIC37100/01/02

## 3-Lead SOT223 Package Outline and Recommended Land Pattern

**TITLE**

3 LEAD SOT223 PACKAGE OUTLINE & RECOMMENDED LAND PATTERN

<b>DRAWING #</b>	SOT223-3LD-PL-1	<b>UNIT</b>	MM
------------------	-----------------	-------------	----



**NOTE:**

1. Dimensions and tolerances are as per ANSI Y14.5M, 1982.
2. Controlling dimension: Millimeters.
3. Dimensions are exclusive of mold flash and gate burr.
4. All specification comply to Jedec spec T0261 Issue C.

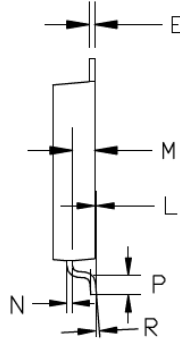
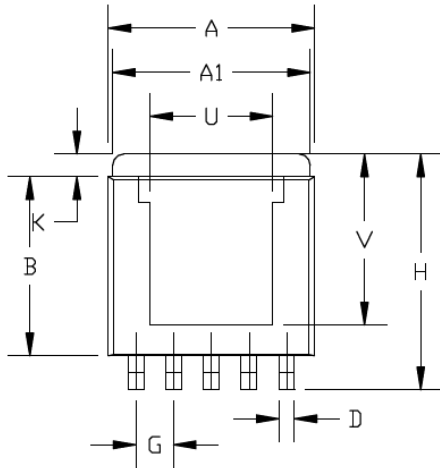
Note: For the most current package drawings, please see the Microchip Packaging Specification located at <http://www.microchip.com/packaging>.

## 5-Lead S-PAK Package Outline and Recommended Land Pattern

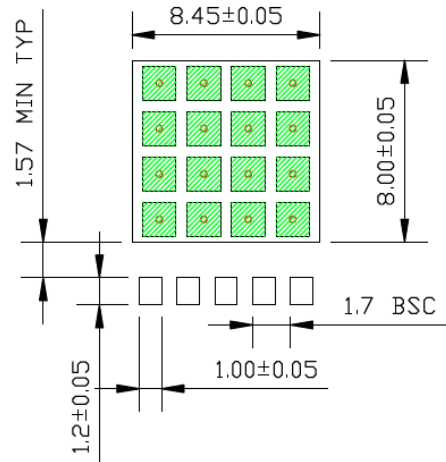
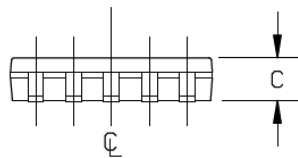
**TITLE**

5 LEAD SPAK PACKAGE OUTLINE & RECOMMENDED LAND PATTERN

<b>DRAWING #</b>	SPAK-5LD-PL-1	<b>UNIT</b>	MM
------------------	---------------	-------------	----



	INCHES		MILLIMETERS	
A	0.365	0.375	9.27	9.52
A1	0.350	0.360	8.89	9.14
B	0.310	0.320	7.87	8.13
C	0.070	0.080	1.78	2.03
D	0.025	0.031	0.63	0.79
E	0.010	BSC	0.25	BSC
G	0.067	BSC	1.70	BSC
H	0.410	0.420	10.41	10.67
K	0.030	0.050	0.76	1.27
L	0.001	0.005	0.03	0.13
M	0.035	0.045	0.89	1.14
N	0.010	BSC	0.25	BSC
P	0.031	0.041	0.79	1.04
R	0°	6°	0°	6°
U	0.220	BSC	5.58	BSC
V	0.296	BSC	7.52	BSC



**RECOMMENDED  
LAND PATTERN**

- NOTE:
1. DIMENSION DOES NOT INCLUDE MOLD FLASH OR PROTRUSIONS.
  2. DIMENSION INCLUDES PLATING THICKNESS. SOLDER MASK OPENING
  3. RED CIRCLES IN LAND PATTERN REPRESENT THERMAL VIA, 0.30MM IN DIAMETER & SHOULD BE CONNECTED TO GND FOR MAXIMUM PERFORMANCE
  4. GREEN RECTANGLES IN LAND PATTERN REPRESENT SOLDER STENCIL OPENING (OPTIONAL), 1.50X1.50MM.

Note: For the most current package drawings, please see the Microchip Packaging Specification located at <http://www.microchip.com/packaging>.

NOTES:

## APPENDIX A: REVISION HISTORY

### Revision A (November 2018)

- Converted Micrel document MIC37100/01/02 to Microchip data sheet DS20006104A.
- Minor text changes throughout.

NOTES:



## PRODUCT IDENTIFICATION SYSTEM

To order or obtain information, e.g., on pricing or delivery, contact your local Microchip representative or sales office.

<u>PART NO.</u>	<u>-X.X</u>	<u>X</u>	<u>XX</u>	<u>-XX</u>
Device	Output Voltage	Junction Temperature Range	Package	Media Type
<b>Device:</b>				
			MIC371xx: 1A Low-Voltage $\mu$ Cap LDO Regulator	
			MIC37100: Fixed $V_{OUT}$ to 1.24V in SOT-223 Package	
			MIC37101: Fixed $V_{OUT}$ to 1.24V in Power SOIC Package	
			MIC37102: Adjustable $V_{OUT}$ to 1.24V in Power SOIC and S-PAK Packages	
<b>Output Voltage:</b>				
			Fixed Output Voltage Option (MIC37100/37101)	
			1.5 = 1.5V	
			1.65 = 1.65V	
			1.8 = 1.8V	
			2.5 = 2.5V	
			3.3 = 3.3V	
			Adjustable <blank> = Adjustable (MIC37102)	
<b>Junction Temperature Range:</b>				
			W = -40°C to +125°C, RoHS Compliant*	
			Y = -40°C to +125°C, RoHS Compliant	
<b>Package:</b>				
			M = 8-Lead SOIC(MIC37101/37102)	
			R = 5-Lead SPAK (MIC37102)	
			S = 3-Lead SOT-223 (MIC37100)	
<b>Media Type:</b>				
			<Blank> = 78/Tube (S, SOT-223)	
			<Blank> = 48/Tube (R, SPAK)	
			<Blank> = 95/Tube (M, SOIC)	
			TR = 2,500/Reel	

### Examples:

- a) MIC37100-1.8WS: 1A Low-Voltage  $\mu$ Cap LDO Regulator, 1.8V Fixed Output Voltage option, -40°C to +125°C Junction Temperature Range, RoHS Compliant\*, 3-Lead SOT-223 Package, 78/Tube
- b) MIC37100-1.8WS-TR: 1A Low-Voltage  $\mu$ Cap LDO Regulator, 1.8V Fixed Output Voltage option, -40°C to +125°C Junction Temperature Range, RoHS Compliant\*, 3-Lead SOT-223 Package, 2500/Reel
- c) MIC37101-1.5YM: 1A Low-Voltage  $\mu$ Cap LDO Regulator, 1.5V Fixed Output Voltage option, -40°C to +125°C Junction Temperature Range, RoHS Compliant, 8-Lead SOIC Package, 95/Tube
- d) MIC37101-1.5YM-TR: 1A Low-Voltage  $\mu$ Cap LDO Regulator, 1.5V Fixed Output Voltage option, -40°C to +125°C Junction Temperature Range, RoHS Compliant, 8-Lead SOIC Package, 2500/Reel
- e) MIC37102YM: 1A Low-Voltage  $\mu$ Cap LDO Regulator, Adjustable Output Voltage, -40°C to +125°C Junction Temperature Range, RoHS Compliant, 8-Lead SOIC Package, 95/Tube
- f) MIC371012YM-TR: 1A Low-Voltage  $\mu$ Cap LDO Regulator, Adjustable Output Voltage, -40°C to +125°C Junction Temperature Range, RoHS Compliant, 8-Lead SOIC Package, 2500/Reel
- g) MIC37102WR: 1A Low-Voltage  $\mu$ Cap LDO Regulator, Adjustable Output Voltage, -40°C to +125°C Junction Temperature Range, RoHS Compliant\*, 5-Lead SPAK Package, 48/Tube
- h) MIC371012WR-TR: 1A Low-Voltage  $\mu$ Cap LDO Regulator, Adjustable Output Voltage, -40°C to +125°C Junction Temperature Range, RoHS Compliant\*, 8-Lead SPAK Package, 2500/Reel

**Note 1:** Tape and Reel identifier only appears in the catalog part number description. This identifier is used for ordering purposes and is not printed on the device package. Check with your Microchip Sales Office for package availability with the Tape and Reel option.

NOTES:

---

---

**Note the following details of the code protection feature on Microchip devices:**

- Microchip products meet the specification contained in their particular Microchip Data Sheet.
- Microchip believes that its family of products is one of the most secure families of its kind on the market today, when used in the intended manner and under normal conditions.
- There are dishonest and possibly illegal methods used to breach the code protection feature. All of these methods, to our knowledge, require using the Microchip products in a manner outside the operating specifications contained in Microchip's Data Sheets. Most likely, the person doing so is engaged in theft of intellectual property.
- Microchip is willing to work with the customer who is concerned about the integrity of their code.
- Neither Microchip nor any other semiconductor manufacturer can guarantee the security of their code. Code protection does not mean that we are guaranteeing the product as “unbreakable.”

Code protection is constantly evolving. We at Microchip are committed to continuously improving the code protection features of our products. Attempts to break Microchip's code protection feature may be a violation of the Digital Millennium Copyright Act. If such acts allow unauthorized access to your software or other copyrighted work, you may have a right to sue for relief under that Act.

---

Information contained in this publication regarding device applications and the like is provided only for your convenience and may be superseded by updates. It is your responsibility to ensure that your application meets with your specifications. MICROCHIP MAKES NO REPRESENTATIONS OR WARRANTIES OF ANY KIND WHETHER EXPRESS OR IMPLIED, WRITTEN OR ORAL, STATUTORY OR OTHERWISE, RELATED TO THE INFORMATION, INCLUDING BUT NOT LIMITED TO ITS CONDITION, QUALITY, PERFORMANCE, MERCHANTABILITY OR FITNESS FOR PURPOSE. Microchip disclaims all liability arising from this information and its use. Use of Microchip devices in life support and/or safety applications is entirely at the buyer's risk, and the buyer agrees to defend, indemnify and hold harmless Microchip from any and all damages, claims, suits, or expenses resulting from such use. No licenses are conveyed, implicitly or otherwise, under any Microchip intellectual property rights unless otherwise stated.

*Microchip received ISO/TS-16949:2009 certification for its worldwide headquarters, design and wafer fabrication facilities in Chandler and Tempe, Arizona; Gresham, Oregon and design centers in California and India. The Company's quality system processes and procedures are for its PIC® MCUs and dsPIC® DSCs, KEELOQ® code hopping devices, Serial EEPROMs, microperipherals, nonvolatile memory and analog products. In addition, Microchip's quality system for the design and manufacture of development systems is ISO 9001:2000 certified.*

**QUALITY MANAGEMENT SYSTEM  
CERTIFIED BY DNV  
= ISO/TS 16949 =**

### Trademarks

The Microchip name and logo, the Microchip logo, AnyRate, AVR, AVR logo, AVR Freaks, BitCloud, chipKIT, chipKIT logo, CryptoMemory, CryptoRF, dsPIC, FlashFlex, flexPWR, Heldo, JukeBlox, KeeLoq, Kleer, LANCheck, LINK MD, maXStylus, maXTouch, MediaLB, megaAVR, MOST, MOST logo, MPLAB, OptoLyzer, PIC, picoPower, PICSTART, PIC32 logo, Prochip Designer, QTouch, SAM-BA, SpyNIC, SST, SST Logo, SuperFlash, tinyAVR, UNI/O, and XMEGA are registered trademarks of Microchip Technology Incorporated in the U.S.A. and other countries.

ClockWorks, The Embedded Control Solutions Company, EtherSynch, Hyper Speed Control, HyperLight Load, IntellIMOS, mTouch, Precision Edge, and Quiet-Wire are registered trademarks of Microchip Technology Incorporated in the U.S.A.

Adjacent Key Suppression, AKS, Analog-for-the-Digital Age, Any Capacitor, AnyIn, AnyOut, BodyCom, CodeGuard, CryptoAuthentication, CryptoAutomotive, CryptoCompanion, CryptoController, dsPICDEM, dsPICDEM.net, Dynamic Average Matching, DAM, ECAN, EtherGREEN, In-Circuit Serial Programming, ICSP, INICnet, Inter-Chip Connectivity, JitterBlocker, KleerNet, KleerNet logo, memBrain, Mindi, MiWi, motorBench, MPASM, MPF, MPLAB Certified logo, MPLIB, MPLINK, MultiTRAK, NetDetach, Omniscient Code Generation, PICDEM, PICDEM.net, PICKit, PICtail, PowerSmart, PureSilicon, QMatrix, REAL ICE, Ripple Blocker, SAM-ICE, Serial Quad I/O, SMART-I.S., SQI, SuperSwitcher, SuperSwitcher II, Total Endurance, TSHARC, USBCheck, VariSense, ViewSpan, WiperLock, Wireless DNA, and ZENA are trademarks of Microchip Technology Incorporated in the U.S.A. and other countries.

SQTP is a service mark of Microchip Technology Incorporated in the U.S.A.

Silicon Storage Technology is a registered trademark of Microchip Technology Inc. in other countries.

GestIC is a registered trademark of Microchip Technology Germany II GmbH & Co. KG, a subsidiary of Microchip Technology Inc., in other countries.

All other trademarks mentioned herein are property of their respective companies.

© 2018, Microchip Technology Incorporated, All Rights Reserved.  
ISBN: 978-1-5224-3841-0



# MICROCHIP

## Worldwide Sales and Service

### AMERICAS

**Corporate Office**  
2355 West Chandler Blvd.  
Chandler, AZ 85224-6199  
Tel: 480-792-7200  
Fax: 480-792-7277  
Technical Support:  
<http://www.microchip.com/support>  
Web Address:  
[www.microchip.com](http://www.microchip.com)

#### Atlanta

Duluth, GA  
Tel: 678-957-9614  
Fax: 678-957-1455

#### Austin, TX

Tel: 512-257-3370

#### Boston

Westborough, MA  
Tel: 774-760-0087  
Fax: 774-760-0088

#### Chicago

Itasca, IL  
Tel: 630-285-0071  
Fax: 630-285-0075

#### Dallas

Addison, TX  
Tel: 972-818-7423  
Fax: 972-818-2924

#### Detroit

Novi, MI  
Tel: 248-848-4000

#### Houston, TX

Tel: 281-894-5983

#### Indianapolis

Noblesville, IN  
Tel: 317-773-8323  
Fax: 317-773-5453  
Tel: 317-536-2380

#### Los Angeles

Mission Viejo, CA  
Tel: 949-462-9523  
Fax: 949-462-9608  
Tel: 951-273-7800

#### Raleigh, NC

Tel: 919-844-7510

#### New York, NY

Tel: 631-435-6000

#### San Jose, CA

Tel: 408-735-9110  
Tel: 408-436-4270

#### Canada - Toronto

Tel: 905-695-1980  
Fax: 905-695-2078

### ASIA/PACIFIC

**Australia - Sydney**  
Tel: 61-2-9868-6733

**China - Beijing**  
Tel: 86-10-8569-7000

**China - Chengdu**  
Tel: 86-28-8665-5511

**China - Chongqing**  
Tel: 86-23-8980-9588

**China - Dongguan**  
Tel: 86-769-8702-9880

**China - Guangzhou**  
Tel: 86-20-8755-8029

**China - Hangzhou**  
Tel: 86-571-8792-8115

**China - Hong Kong SAR**  
Tel: 852-2943-5100

**China - Nanjing**  
Tel: 86-25-8473-2460

**China - Qingdao**  
Tel: 86-532-8502-7355

**China - Shanghai**  
Tel: 86-21-3326-8000

**China - Shenyang**  
Tel: 86-24-2334-2829

**China - Shenzhen**  
Tel: 86-755-8864-2200

**China - Suzhou**  
Tel: 86-186-6233-1526

**China - Wuhan**  
Tel: 86-27-5980-5300

**China - Xian**  
Tel: 86-29-8833-7252

**China - Xiamen**  
Tel: 86-592-2388138

**China - Zhuhai**  
Tel: 86-756-3210040

### ASIA/PACIFIC

**India - Bangalore**  
Tel: 91-80-3090-4444

**India - New Delhi**  
Tel: 91-11-4160-8631

**India - Pune**  
Tel: 91-20-4121-0141

**Japan - Osaka**  
Tel: 81-6-6152-7160

**Japan - Tokyo**  
Tel: 81-3-6880-3770

**Korea - Daegu**  
Tel: 82-53-744-4301

**Korea - Seoul**  
Tel: 82-2-554-7200

**Malaysia - Kuala Lumpur**  
Tel: 60-3-7651-7906

**Malaysia - Penang**  
Tel: 60-4-227-8870

**Philippines - Manila**  
Tel: 63-2-634-9065

**Singapore**  
Tel: 65-6334-8870

**Taiwan - Hsin Chu**  
Tel: 886-3-577-8366

**Taiwan - Kaohsiung**  
Tel: 886-7-213-7830

**Taiwan - Taipei**  
Tel: 886-2-2508-8600

**Thailand - Bangkok**  
Tel: 66-2-694-1351

**Vietnam - Ho Chi Minh**  
Tel: 84-28-5448-2100

### EUROPE

**Austria - Wels**  
Tel: 43-7242-2244-39  
Fax: 43-7242-2244-393

**Denmark - Copenhagen**  
Tel: 45-4450-2828  
Fax: 45-4485-2829

**Finland - Espoo**  
Tel: 358-9-4520-820

**France - Paris**  
Tel: 33-1-69-53-63-20  
Fax: 33-1-69-30-90-79

**Germany - Garching**  
Tel: 49-8931-9700

**Germany - Haan**  
Tel: 49-2129-3766400

**Germany - Heilbronn**  
Tel: 49-7131-67-3636

**Germany - Karlsruhe**  
Tel: 49-721-625370

**Germany - Munich**  
Tel: 49-89-627-144-0  
Fax: 49-89-627-144-44

**Germany - Rosenheim**  
Tel: 49-8031-354-560

**Israel - Ra'anana**  
Tel: 972-9-744-7705

**Italy - Milan**  
Tel: 39-0331-742611  
Fax: 39-0331-466781

**Italy - Padova**  
Tel: 39-049-7625286

**Netherlands - Drunen**  
Tel: 31-416-690399  
Fax: 31-416-690340

**Norway - Trondheim**  
Tel: 47-7288-4388

**Poland - Warsaw**  
Tel: 48-22-3325737

**Romania - Bucharest**  
Tel: 40-21-407-87-50

**Spain - Madrid**  
Tel: 34-91-708-08-90  
Fax: 34-91-708-08-91

**Sweden - Gothenberg**  
Tel: 46-31-704-60-40

**Sweden - Stockholm**  
Tel: 46-8-5090-4654

**UK - Wokingham**  
Tel: 44-118-921-5800  
Fax: 44-118-921-5820

# Mouser Electronics

Authorized Distributor

Click to View Pricing, Inventory, Delivery & Lifecycle Information:

## Microchip:

[MIC37101-1.5YM](#) [MIC37101-2.5YM](#) [MIC37102YM](#) [MIC37100-2.5WS](#) [MIC37101-3.3YM](#) [MIC37100-1.5WS](#)  
[MIC37100-1.8WS](#) [MIC37100-3.3WS](#) [MIC37100-3.3WS TR](#) [MIC37102WR](#) [MIC37101-1.8YM](#) [MIC37101-2.1YM](#)  
[MIC37100-2.5WS TR](#) [MIC37101-3.3YM TR](#) [MIC37101-2.1YM TR](#) [MIC37101-1.65YM TR](#) [MIC37102YM TR](#)  
[MIC37101-2.5YM TR](#) [MIC37110-1.8YM TR](#) [MIC37101-1.65YM](#) [MIC37100-1.5WS TR](#) [MIC37102WR TR](#) [MIC37101-](#)  
[1.8YM TR](#) [MIC37100-1.65WS TR](#) [MIC37100-1.65WS](#) [MIC37100-1.8WS TR](#) [MIC37101-1.5YM TR](#) [MIC37100-1.5WS-](#)  
[TR](#) [MIC37100-3.3WS-TR](#) [MIC37101-2.5YM-TR](#) [MIC37102YM-TR](#) [MIC37100-1.8WS-TR](#) [MIC37101-1.8YM-TR](#)  
[MIC37101-3.3YM-TR](#) [MIC37101-1.65YM-TR](#) [MIC37101-1.5YM-TR](#) [MIC37101-2.1YM-TR](#) [MIC37100-1.65WS-TR](#)  
[MIC37100-2.5WS-TR](#)