

Mar.1.2020 Copyright 2020 HIROSE ELECTRIC CO., LTD. All Rights Reserved.
In case of consideration for using Automotive equipment / device which demand high reliability, kindly contact our sales window

△數 COUNT	訂正事項 DESCRIPTION OF REVISIONS	擔當 B Y	檢圖 CHKD	年月日 DATE	△數 COUNT	訂正事項 DESCRIPTION OF REVISIONS	擔當 B Y	檢圖 CHKD	年月日 DATE
①	1 RE-6-1150	K.I.Y	L.S.M	18. 07. 04	△				
②	1 RE-6-1579	K.I.Y	L.S.M	20. 01. 23	△				
△					△				

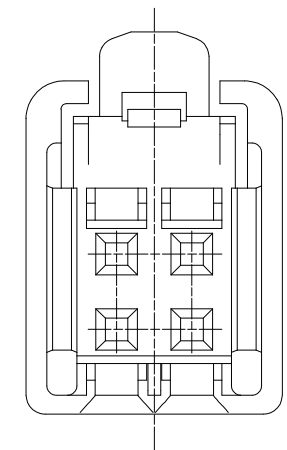

NOTE 1. 1PACK CONTAINS 100PCS.
 △ 2. UL(File No. E132750) AUTHORIZATION ARTICLE.
 C-UL(File No. E132750) AUTHORIZATION ARTICLE.

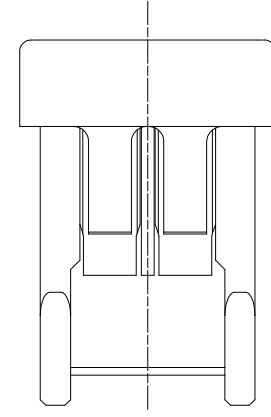
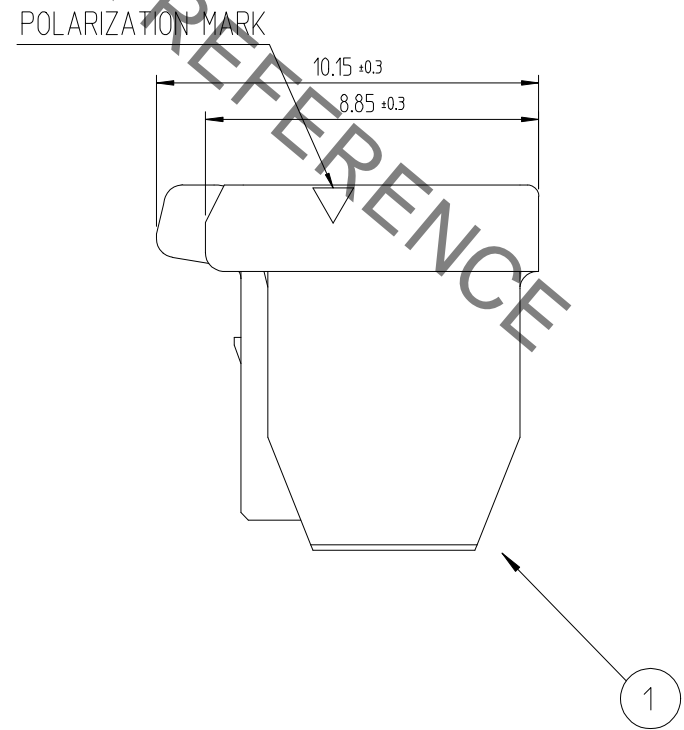
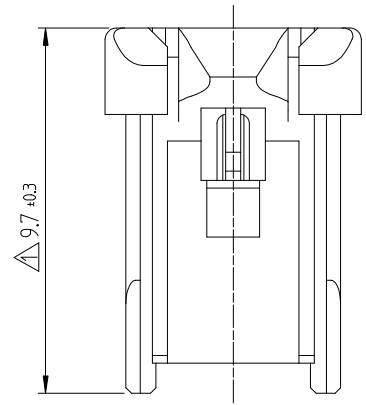
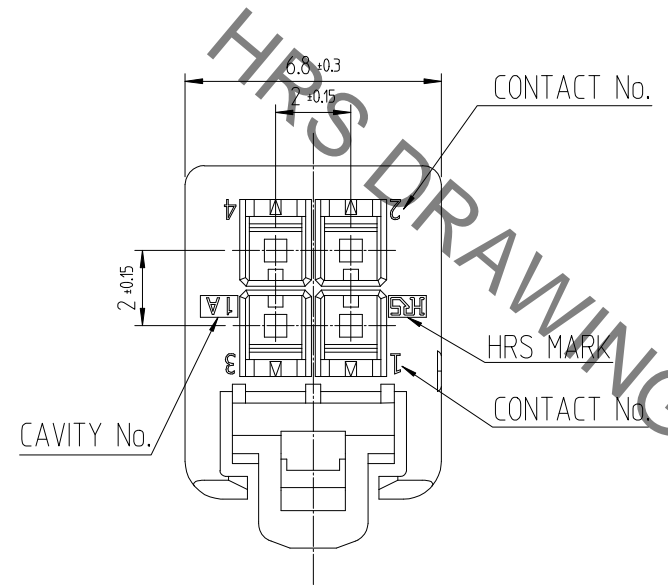

NO.	MATERIAL	FINISH,REMARKS	NO.	MATERIAL	FINISH,REMARKS
			1	PBT	UL94V-0, BLACK
CODE NO. (OLD)			DRAWN		
			CHOI	DESIGNED	CHECKED
			17.12.22	CHOI	17.12.22
			J.S	J.S	LIM
					17.12.22
					S.M
					KANG
					17.12.22
					T.S
					ENG
					20.02.12
					DEPT
DRAWING NO. DF51K-4DP-2DSA			PART NO. DF51K-4DS-2C (800)		
SCALE 5:1			CODE NO. CL 6652-0025-0-800		
UNITS mm			1/1		