

Bridgelux® SMD 2835 0.2W 3V Thrive™

Product Data Sheet DS311



Introduction

Bridgelux Thrive™ combines unique chip, phosphor and packaging technology to closely match the spectra of natural light over the visible wavelength range. Thrive can be used in constant color point luminaires to bring full spectrum natural light indoors or in tunable white luminaires to incorporate circadian elements that may impact human well-being. The high fidelity spectral output of Thrive creates stunning environments with excellent color rendering and outstanding TM30 metrics. Thrive is available in both SMD components and LED arrays to enable a broad range of lighting applications including retail, hospitality, office, education, architectural, museums, healthcare and residential lighting.

Features

- Engineered spectra to closely match natural light
- CRI > 95, R1-R15 >90, high Rf and Rg values
- High efficiency full spectrum solution
- No violet chip augmentation
- Hot color targeted
- Industry standard 2835 footprint
- Broad product platform availability (SMDs and COBs)

Benefits

- Full consistent spectrum with fewer spectral spikes
- Natural and vivid color rendering
- Greater energy savings, lower utility costs
- Economical, high efficiency solution
- Uniform and consistent white light under application conditions
- Ease of design and rapid go-to-market
- Enables greater design flexibility and platform color consistency

Contents

Product Feature Map	2
Product Nomenclature	2
Product Test Conditions	2
Product Selection Guide	3
Spectrum Characteristics	4
Electrical Characteristics	7
Absolute Maximum Ratings	8
Product Bin Definitions	9
Performance Curves	12
Typical Radiation Pattern	13
Mechanical Dimensions	14
Reliability	15
Reflow Characteristics	16
Packaging	17
Design Resources	19
Precautions	19
Disclaimers	19
About Bridgelux	20

Product Feature Map

Bridgelux SMD LED products come in industry standard package sizes and follow ANSI binning standards. These LEDs are optimized for cost and performance, helping to ensure highly competitive system lumen per dollar performance while addressing the stringent efficacy and reliability standards required for modern lighting applications.

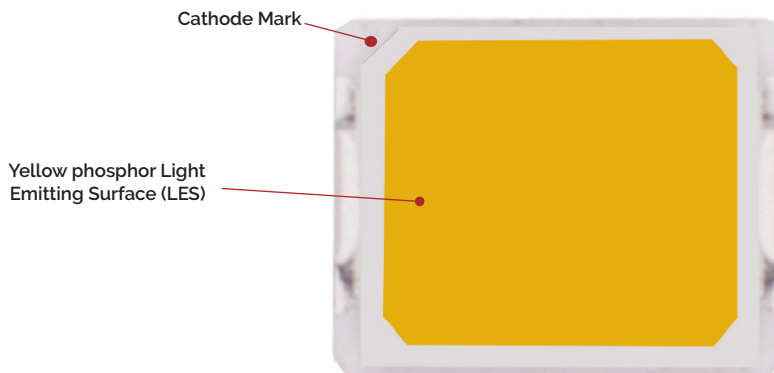

Product Nomenclature

The part number designation for Bridgelux SMD 2835 is explained as follows:

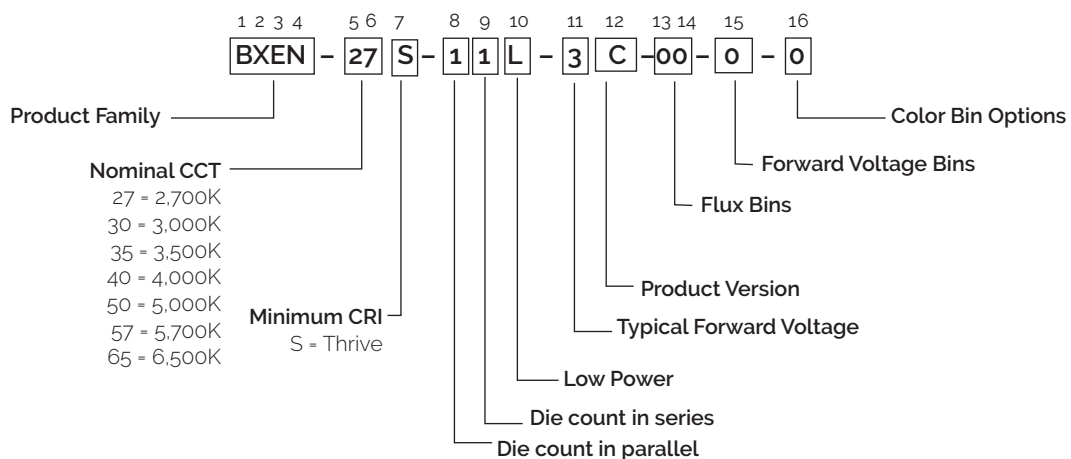

Product Test Conditions

Bridgelux SMD 2835 LEDs are tested and binned with a 10ms pulse of 60mA at T_j (junction temperature) = T_{sp} (solder point temperature) = 25°C. Forward voltage and luminous flux are binned at a $T_j = T_{sp} = 25^\circ\text{C}$, while color is hot targeted at a T_{sp} of 85°C.

Product Selection Guide

The following product configurations are available:

Table 1: Selection Guide, Pulsed Measurement Data at 60mA ($T_j = T_{sp} = 25^\circ\text{C}$)

Part Number ^{1,6}	Nominal CCT ² (K)	CRI ^{3,5} (Typical)	Nominal Drive Current (mA)	Forward Voltage ^{4,5} (V)			Typical Pulsed Flux (lm) ^{4,5}			Typical Power (W)	Typical Efficacy (lm/W)
				Min	Typical	Max	Min	Typical	Max		
BXEN-27S-11L-3C-00-0-0	2700	97	60	2.70	2.90	3.10	20.0	22.0	24.0	0.2	126
BXEN-30S-11L-3C-00-0-0	3000	97	60	2.70	2.90	3.10	22.0	23.0	24.0	0.2	132
BXEN-35S-11L-3C-00-0-0	3500	97	60	2.70	2.90	3.10	22.0	24.0	26.0	0.2	138
BXEN-40S-11L-3C-00-0-0	4000	97	60	2.70	2.90	3.10	22.0	25.0	28.0	0.2	144
BXEN-50S-11L-3C-00-0-0	5000	97	60	2.70	2.90	3.10	22.0	25.0	28.0	0.2	144
BXEN-57S-11L-3C-00-0-0	5700	97	60	2.70	2.90	3.10	22.0	25.0	28.0	0.2	144
BXEN-65S-11L-3C-00-0-0	6500	97	60	2.70	2.90	3.10	22.0	25.0	28.0	0.2	144

Table 2: Selection Guide, Pulsed Test Performance at 60mA ($T_{sp} = 85^\circ\text{C}$)^{7,8}

Part Number ^{1,6}	Nominal CCT ² (K)	CRI ^{3,5} (Typical)	Nominal Drive Current (mA)	Forward Voltage ⁵ (V)			Typical Pulsed Flux (lm) ⁵			Typical Power (W)	Typical Efficacy (lm/W)
				Min	Typical	Max	Min	Typical	Max		
BXEN-27S-11L-3C-00-0-0	2700	97	60	2.63	2.83	3.03	17.8	19.6	21.3	0.2	115
BXEN-30S-11L-3C-00-0-0	3000	97	60	2.63	2.83	3.03	19.5	20.4	21.3	0.2	126
BXEN-35S-11L-3C-00-0-0	3500	97	60	2.63	2.83	3.03	19.5	21.3	23.1	0.2	126
BXEN-40S-11L-3C-00-0-0	4000	97	60	2.63	2.83	3.03	19.5	22.2	24.9	0.2	131
BXEN-50S-11L-3C-00-0-0	5000	97	60	2.63	2.83	3.03	19.5	22.2	24.9	0.2	131
BXEN-57S-11L-3C-00-0-0	5700	97	60	2.63	2.83	3.03	19.5	22.2	24.9	0.2	131
BXEN-65S-11L-3C-00-0-0	6500	97	60	2.63	2.83	3.03	19.5	22.2	24.9	0.2	131

Notes for Tables 1 & 2:

- The last 6 characters (including hyphens '-') refer to flux bins, forward voltage bins, and color bin options, respectively. "00-0-0" denotes the full distribution of flux, forward voltage, and 6 SDCM color.
Example: BXEN-27S-11L-3C-00-0-0 refers to the full distribution of flux, forward voltage, and color within a 2700K 6-step ANSI standard chromaticity region with a minimum of 97 CRI, 1x1 die configuration, low power, 2.9V typical forward voltage.
- Product CCT is hot targeted at $T_{sp} = 85^\circ\text{C}$. Nominal CCT as defined by ANSI C78.377-2011.
- Listed CRIs are minimum values and include test tolerance.
- Products tested under pulsed condition (10ms pulse width) at nominal drive current where $T_j = T_{sp} = 25^\circ\text{C}$.
- Bridgelux maintains a $\pm 7.5\%$ tolerance on luminous flux measurements, $\pm 0.1\text{V}$ tolerance on forward voltage measurements, and ± 2 tolerance on CRI measurements for the SMD 2835.
- Refer to Table 6 and Table 7 for Bridgelux SMD 2835 Luminous Flux Binning and Forward Voltage Binning information.
- Typical pulsed test performance values are provided as reference only and are not a guarantee of performance.
- Typical performance is estimated based on operation under pulsed current with LED emitter mounted onto a heat sink with thermal interface material and the solder point temperature maintained at 85°C . Based on Bridgelux test setup, values may vary depending on the thermal design of the luminaire and/or the exposed environment to which the product is subjected.
- Photosynthetic Photon Flux is measure of photon flux in the 400nm-700nm region.

Spectrum Characteristics

Table 3: Typical Color Rendering Index and TM-30 Values, 60mA, $T_{sp} = 85^{\circ}\text{C}^1$

Nominal CCT ²	R _f	R _g	R ₁	R ₂	R ₃	R ₄	R ₅	R ₆	R ₇	R ₈	R ₉	R ₁₀	R ₁₁	R ₁₂	R ₁₃	R ₁₄	R ₁₅
2700K	95	100	97	98	99	96	96	94	98	98	95	96	93	92	96	99	99
3000K	96	100	97	98	98	97	97	96	99	99	97	98	94	96	97	98	99
3500K	95	98	99	98	95	98	99	98	98	97	91	94	97	94	99	96	98
4000K	95	98	99	99	96	98	99	98	99	99	97	96	97	94	99	97	99
5000K	90	97	96	94	96	94	94	96	95	91	97	92	95	96	95	98	97
5700K	97	100	99	99	99	98	99	98	99	94	94	97	99	97	99	99	98
6500K	96	99	99	98	98	98	100	99	98	98	98	97	99	97	99	99	99

Note for Table 3:

1. Bridgelux maintains a tolerance of ± 3 on Color Rendering Index R1-R15 measurements and TM-30 measurements.
2. Rn reference by Nominal Drive Current will have deviations when changed drive current.

Figure 1: 2700K Thrive TM-30 Graphs

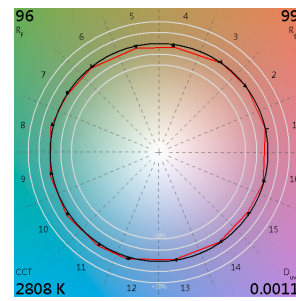
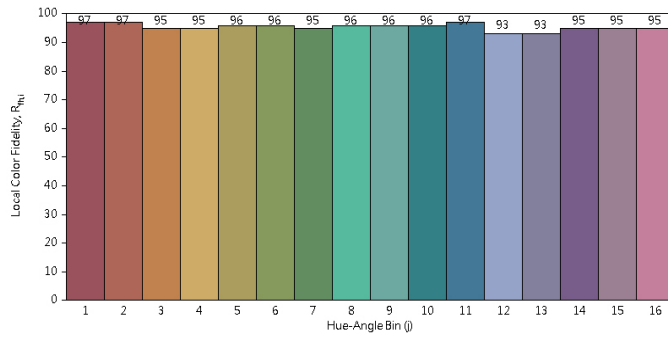

Figure 2: 3000K Thrive TM-30 Graphs

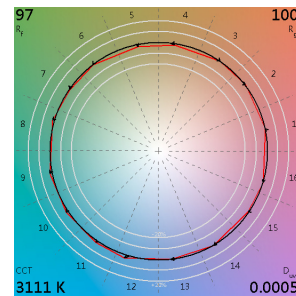
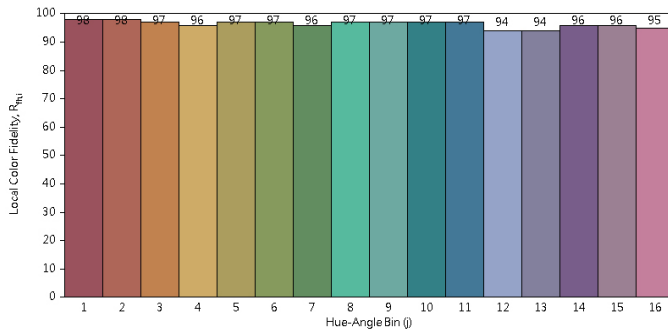
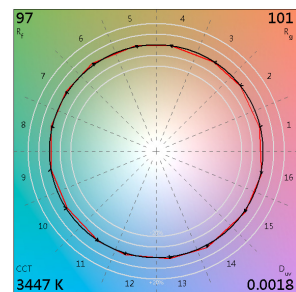
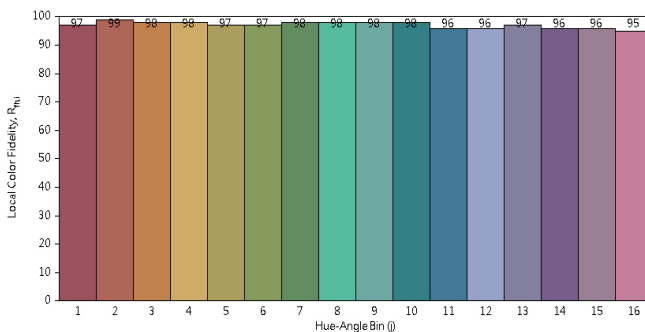

Figure 3: 3500K Thrive TM-30 Graphs



Spectrum Characteristics

Figure 3: 4000K Thrive TM-30 Graphs

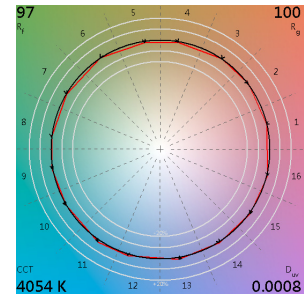
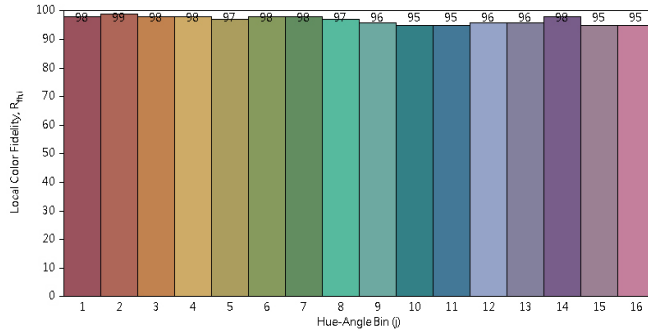

Figure 4: 5000K Thrive TM-30 Graphs

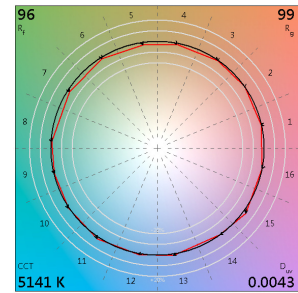
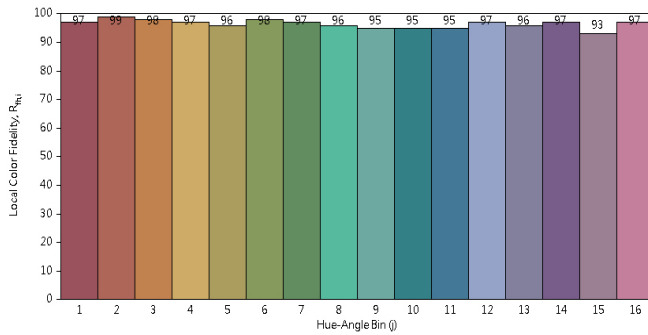

Figure 5: 5700K Thrive TM-30 Graphs

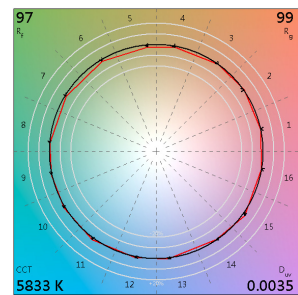
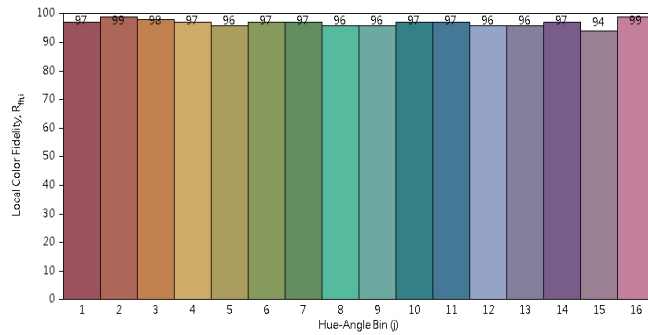
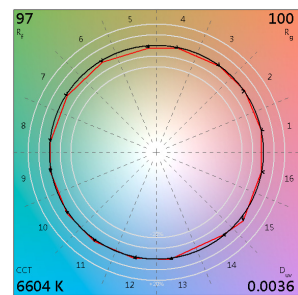
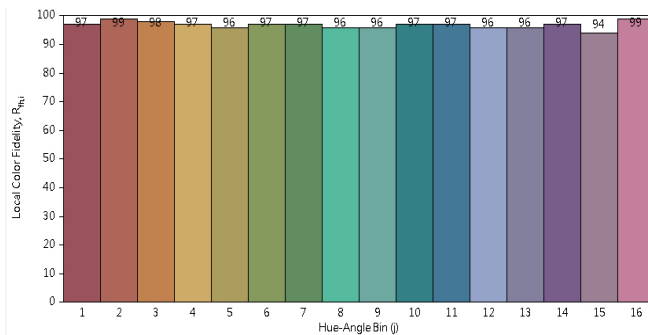
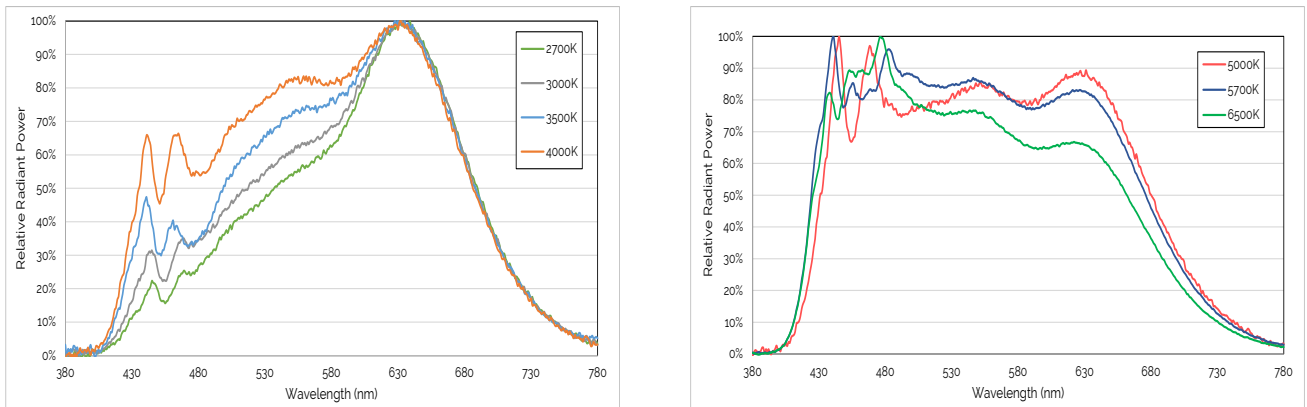

Figure 6: 6500K Thrive TM-30 Graphs



Spectrum Characteristics

Figure 5: Typical Color Spectrum



Note for Figure 5:

1. Color spectra measured at nominal current for $T_{sp} = 85^{\circ}\text{C}$.

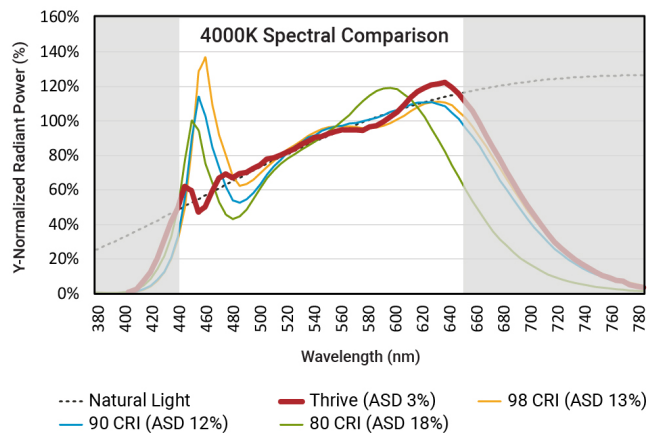

Spectral Matching to Natural Light

Humans have evolved and thrived for millions of years under the sun's natural daylight. While discussions continue regarding the development of LED products with artificial spectra aimed at increasing productivity and focus or helping with relaxation, the long-term physiological effects of such altered environments on humans remains unknown.

Bridgelux Thrive is engineered to provide the closest match to natural light using proprietary chip, phosphor and packaging technology. Bridgelux is working with our customers and industry partners to define new metrics to describe and quantify this spectral matching; going beyond today's quality of light metrics such as CRI and TM-30.

To quantify spectral matching, Bridgelux has defined a new term; Average Spectral Difference (ASD). ASD is calculated by measuring the absolute difference between the LED spectrum and a natural light source spectrum at discrete wavelengths. These values are then averaged across different wavelength ranges and reported as a percentage. Natural light is defined by the Black Body Curve for sources below 5000K or by the CIE Standard Illuminant D for sources of 5000K or above (D50 for example).

Bridgelux Thrive has an ASD between 3% and 7% for all color points (2700K – 6500K) across the typical LED wavelength range of 440-650nm. This includes a very close spectral match, with an ASD of only 2% for some color point options, in the blue/cyan color range where most other LED light sources suffer. For comparison purposes, standard 80, 90 and 98 CRI light sources have an ASD that is 2-6 times larger than Thrive over the same wavelength range and up to 20 times greater in the cyan wavelength range.

As the industry evolves toward human centric lighting, Bridgelux will work with our customers and industry experts to educate the market about the benefits of the ASD metric to further quantify the quality of light.

Electrical Characteristics

Table 4: Electrical Characteristics

Part Number ¹	Drive Current (mA)	Forward Voltage (V) ^{2,3}			Typical Temperature Coefficient of Forward Voltage $\Delta V_f / \Delta T$ (mV/°C)	Typical Thermal Resistance Junction to Solder Point ⁴ R_{J-sp} (°C/W)
		Minimum	Typical	Maximum		
BXEN-XXX-11L-3C-00-0-0	60	2.7	2.9	3.1	-1.20	27

Notes for Table 4:

- The last 6 characters (including hyphens '-') refer to flux bins, forward voltage bins, and color bin options, respectively. "00-0-00" denotes the full distribution of flux, forward voltage, and 6 SDCM color.
Example: BXEN-27S-11L-3C-00-0-0 refers to the full distribution of flux, forward voltage, and color within a 2700K 6-step ANSI standard chromaticity region with a minimum of 97 CRI, 1x1 die configuration, low power, 2.9V typical forward voltage.
- Bridgelux maintains a tolerance of $\pm 0.1V$ on forward voltage measurements. Voltage minimum and maximum values at the nominal drive current are guaranteed by 100% test.
- Products tested under pulsed condition (10ms pulse width) at nominal drive current where $T_{sp} = 25^\circ C$.
- Thermal resistance value was calculated using total electrical input power; optical power was not subtracted from input power.

Absolute Maximum Ratings

Table 5: Maximum Ratings

Parameter	Maximum Rating
LED Junction Temperature (T_j)	125°C
Storage Temperature	-40°C to +105°C
Operating Solder Point Temperature (T_{sp})	-40°C to +105°C
Soldering Temperature	260°C or lower for a maximum of 10 seconds
Maximum Drive Current	80mA
Maximum Peak Pulsed Forward Current ¹	160mA
Maximum Reverse Voltage ²	-
Moisture Sensitivity Rating	MSL 3
Electrostatic Discharge	2kV HBM. JEDEC-JS-001-HBM and JEDEC-JS-001-2012

Notes for Table 5:

1. Bridgelux recommends a maximum duty cycle of 10% and pulse width of 10 ms when operating LED SMD at maximum peak pulsed current specified. Maximum peak pulsed current indicate values where LED SMD can be driven without catastrophic failures.
2. Light emitting diodes are not designed to be driven in reverse voltage and will not produce light under this condition. no rating is provided.

Product Bin Definitions

Table 6 lists the standard photometric luminous flux bins for Bridgelux SMD 2835 LEDs. Although several bins are listed, product availability in a particular bin varies by production run and by product performance. Not all bins are available in all CCTs.

Table 6: Luminous Flux Bin Definitions at 60mA, $T_{sp}=25^{\circ}\text{C}$

Bin Code	Minimum	Maximum	Unit	Condition
19	20	22	lm	$I_F=60\text{mA}$
1A	22	24		
1B	24	26		
1C	26	28		
1D	28	30		

Note for Table 6:

1. Bridgelux maintains a tolerance of $\pm 7.5\%$ on luminous flux measurements.

Table 7: Forward Voltage Bin Definition at 60mA, $T_{sp}=25^{\circ}\text{C}$

Bin Code	Minimum	Maximum	Unit	Condition
9	2.7	2.8	V	$I_F=60\text{mA}$
A	2.8	2.9		
B	2.9	3.0		
C	3.0	3.1		
D	3.1	3.2		

Note for Table 7:

1. Bridgelux maintains a tolerance of $\pm 0.1\text{V}$ on forward voltage measurements.

Product Bin Definitions

Table 8: MacAdam Ellipse Color Bin Definitions

CCT	Color Space	Center Point		Major Axis	Minor Axis	Ellipse Rotation Angle	Color Bin
		X	Y				
2700K	2 SDCM	0.4578	0.4101	0.0054	0.0028	53.70	2
	3 SDCM	0.4578	0.4101	0.0081	0.0042	53.70	2/3
	6 SDCM	0.4578	0.4101	0.0162	0.0084	53.70	2/3/A/B/C/D/E/F
3000K	2 SDCM	0.4338	0.4030	0.00556	0.00272	53.22	2
	3 SDCM	0.4338	0.4030	0.00834	0.00408	53.22	2/3
	6 SDCM	0.4338	0.4030	0.01668	0.00816	53.22	2/3/A/B/C/D/E/F
3500K	2 SDCM	0.4073	0.3917	0.00618	0.00276	54.00	2
	3 SDCM	0.4073	0.3917	0.00927	0.00414	54.00	2/3
	6 SDCM	0.4073	0.3917	0.01854	0.00828	54.00	2/3/A/B/C/D/E/F
4000K	2 SDCM	0.3818	0.3797	0.00626	0.00268	53.72	2
	3 SDCM	0.3818	0.3797	0.00939	0.00402	53.72	2/3
	6 SDCM	0.3818	0.3797	0.01878	0.00804	53.72	2/3/A/B/C/D/E/F
5000K	3 SDCM	0.3447	0.3553	0.00822	0.00354	59.62	3
	6 SDCM	0.3447	0.3553	0.01644	0.00708	59.62	3/A/B/C/D/E/F
5700K	3 SDCM	0.3287	0.3417	0.00746	0.00320	59.09	3
	6 SDCM	0.3287	0.3417	0.01492	0.00640	59.09	3/A/B/C/D/E/F
6500K	3 SDCM	0.3123	0.3282	0.00669	0.00285	58.57	3
	6 SDCM	0.3123	0.3282	0.01338	0.0057	58.57	3/A/B/C/D/E/F

Notes for Table 8:

1. Color binning at $T_{sp} = 85^{\circ}\text{C}$ unless otherwise specified
2. Bridgelux maintains a tolerance of ± 0.007 on x and y color coordinates in the CIE 1931 color space.

Product Bin Definitions

Figure 6: C.I.E. 1931 Chromaticity Diagram (Color Targeted at $T_{sp} = 85^{\circ}\text{C}$)

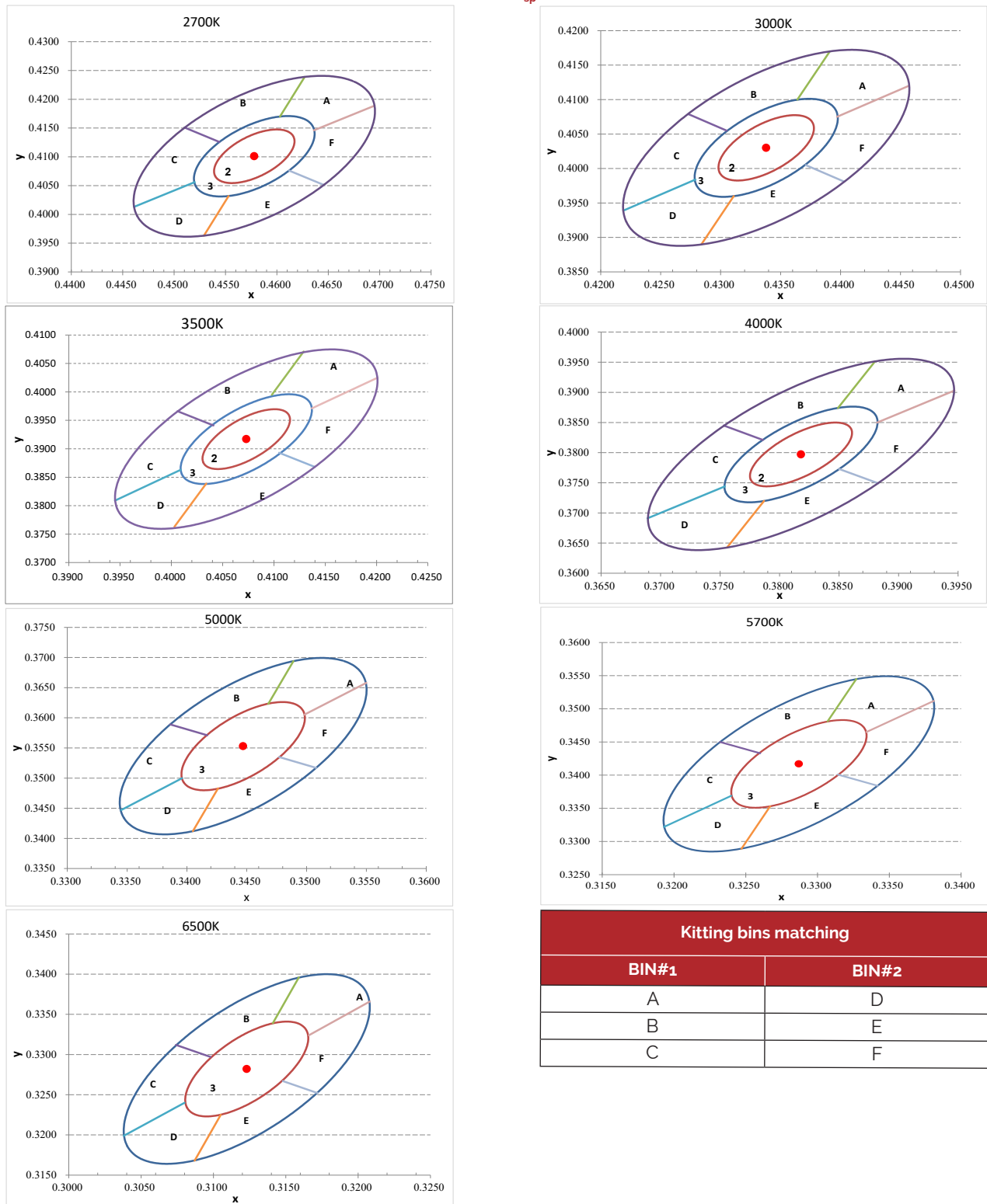

Kitting bins matching	
BIN#1	BIN#2
A	D
B	E
C	F

Performance Curves

Figure 7: Drive Current vs. Voltage ($T_{sp}=25^{\circ}\text{C}$)

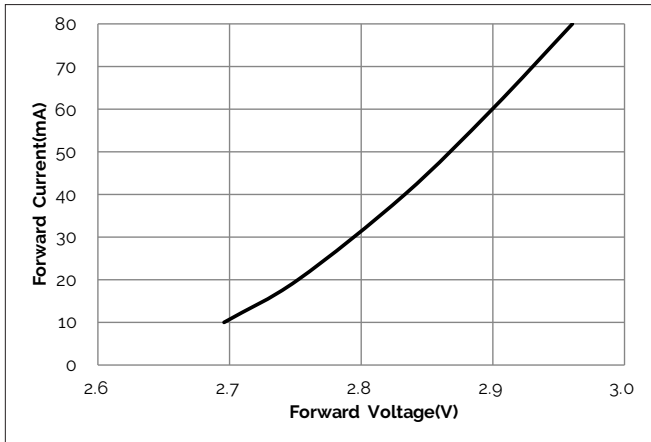

Figure 8: Typical Relative Luminous Flux vs. Drive Current ($T_{sp}=25^{\circ}\text{C}$)¹

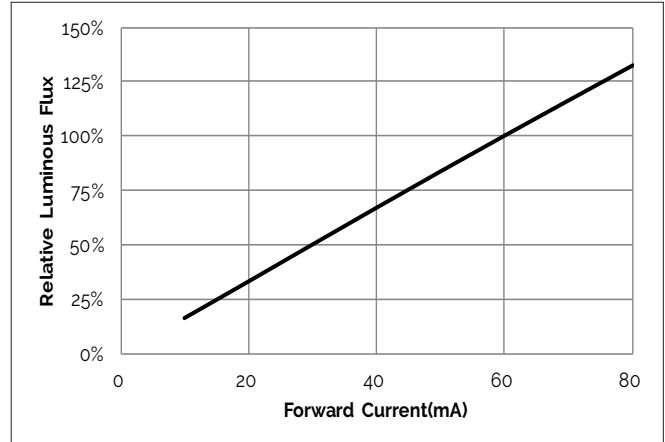

Figure 9: Typical Relative Flux vs. Solder Point Temperature^{2,3,4,5}

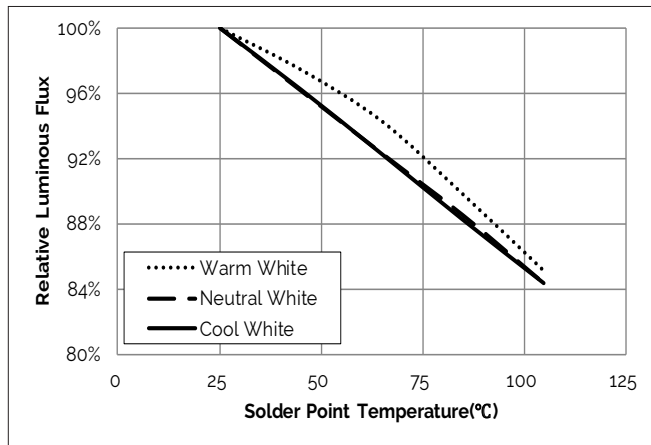

Figure 10: Typical c_x Shift vs. Solder Point Temperature^{2,3,4,5}

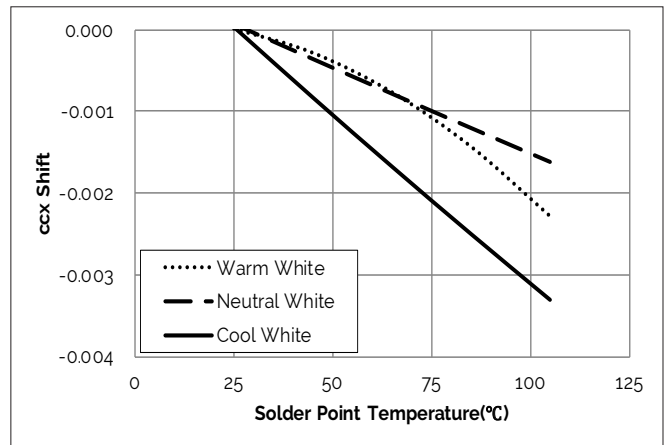
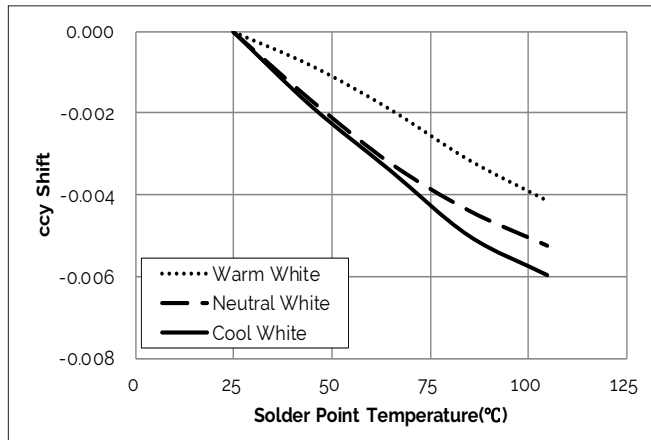

Figure 11: Typical c_y Shift vs. Solder Point Temperature^{2,3,4,5}



Note for Figures 7-11:

1. Bridgelux does not recommend driving high power LEDs at low currents. Doing so may produce unpredictable results. Pulse width modulation (PWM) is recommended for dimming effects.
2. Characteristics shown for warm white based on 2700K.
3. Characteristics shown for neutral white based on 4000K.
4. Characteristics shown for cool white based on 5000K.
5. For other color SKUs, the shift in color will vary. Please contact your Bridgelux Sales Representative for more information.

Typical Radiation Pattern

Figure 12: Typical Spatial Radiation Pattern at 60mA, $T_{sp} = 25^{\circ}\text{C}$

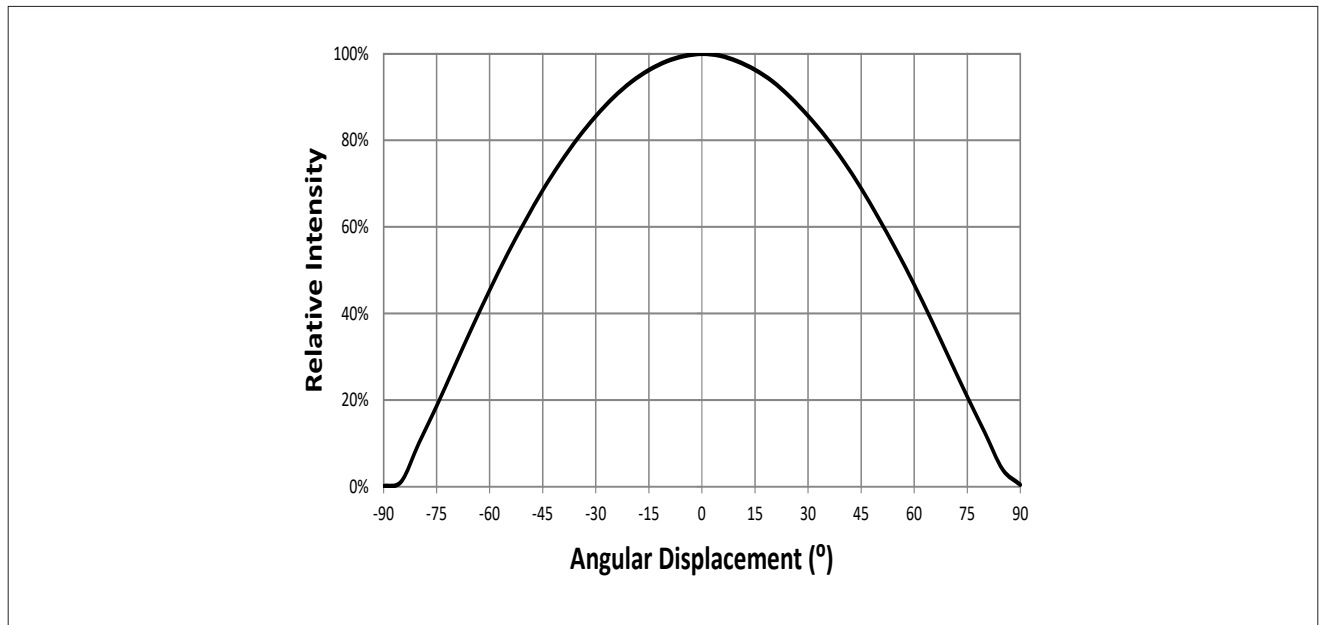

Notes for Figure 12:

1. Typical viewing angle is 116° .
2. The viewing angle is defined as the off axis angle from the centerline where luminous intensity (Iv) is $\frac{1}{2}$ of the peak value.

Figure 13: Typical Polar Radiation Pattern at 60mA, $T_{sp} = 25^{\circ}\text{C}$

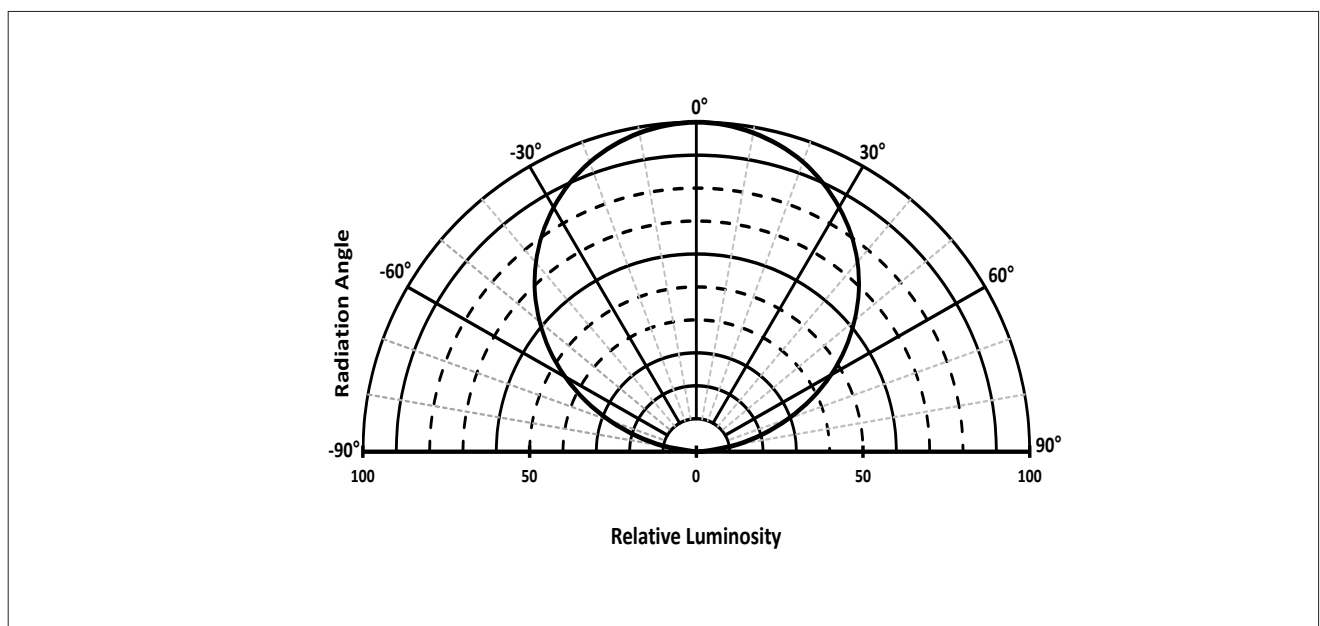

Mechanical Dimensions

Figure 14: Drawing for SMD 2835

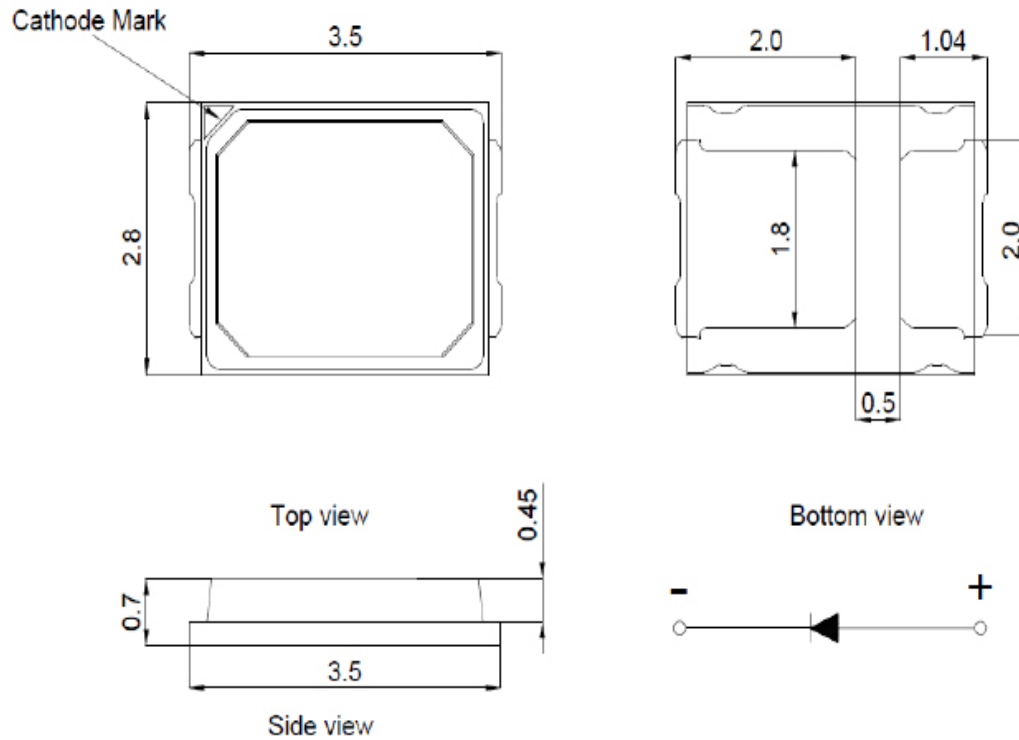

Notes for Figure 14:

1. Drawings are not to scale.
2. Drawing dimensions are in millimeters.
3. Unless otherwise specified, tolerances are $\pm 0.10\text{mm}$.

Recommended PCB Soldering Pad Pattern

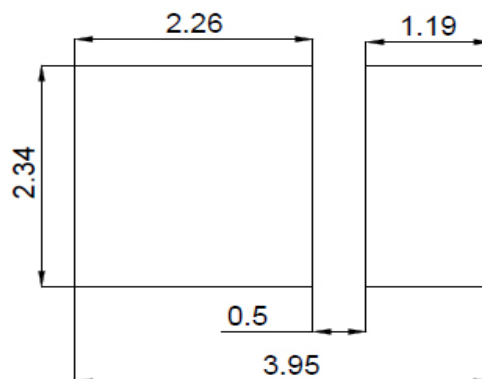

Reliability

Table 9: Reliability Test Items and Conditions

No .	Items	Reference Standard	Test Conditions	Drive Current	Test Duration	Units Failed/Tested
1	Moisture/Reflow Sensitivity	J-STD-020E	$T_{\text{std}} = 260^{\circ}\text{C}$, 10sec, Precondition: 60°C , 60%RH, 168hr	-	3 reflows	0/22
2	Low Temperature Storage	JESD22-A119	$T_{\text{a}} = -40^{\circ}\text{C}$	-	1000 hours	0/22
3	High Temperature Storage	JESD22-A103D	$T_{\text{a}} = 105^{\circ}\text{C}$	-	1000 hours	0/22
4	Low Temperature Operating Life	JESD22-A108D	$T_{\text{a}} = -40^{\circ}\text{C}$	60mA	1000 hours	0/22
5	Temperature Humidity Operating Life	JESD22-A101C	$T_{\text{sp}} = 85^{\circ}\text{C}$, RH=85%	60mA	1000 hours	0/22
6	High Temperature Operating Life	JESD22-A108D	$T_{\text{sp}} = 105^{\circ}\text{C}$	80mA	1000 hours	0/22
7	Power switching	IEC62717:2014	$T_{\text{sp}} = 105^{\circ}\text{C}$ 30 sec on, 30 sec off	80mA	30000 cycles	0/22
8	Thermal Shock	JESD22-A106B	$T_{\text{a}} = -40^{\circ}\text{C} \sim 100^{\circ}\text{C}$; Dwell : 15min; Transfer: 10sec	-	200 cycles	0/22
9	Temperature Cycle	JESD22-A104E	$T_{\text{a}} = -40^{\circ}\text{C} \sim 100^{\circ}\text{C}$; Dwell at extreme temperature: 15min; Ramp rate $< 105^{\circ}\text{C}/\text{min}$	-	200 cycles	0/22
10	Electrostatic Discharge	JS-001-2012	HBM, 2kV, 1.5k Ω , 100pF, Alternately positive or negative	-	-	0/22

Passing Criteria

Item	Symbol	Test Condition	Passing Criteria
Forward Voltage	Vf	60mA	$\Delta V_f < 10\%$
Luminous Flux	Fv	60mA	$\Delta F_v < 30\%$
Chromaticity Coordinates	(x, y)	60mA	$\Delta u'v' < 0.007$

Notes for Table 9:

1. Measurements are performed after allowing the LEDs to return to room temperature
2. T_{std} : reflow soldering temperature; T_{a} : ambient temperature

Reflow Characteristics

Figure 15 : Reflow Profile

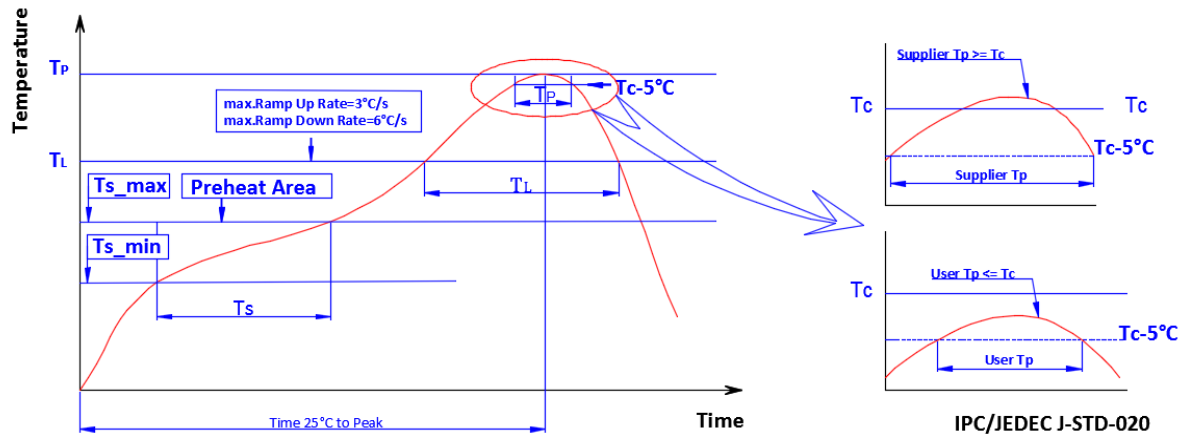

Profile Feature	Lead Free Assembly
Temperature Min. (Ts_min)	160°C
Temperature Max. (Ts_max)	205°C
Time (ts) from Ts_min to Ts_max	60-150 seconds
Ramp-Up Rate (TL to Tp)	3 °C/second
Liquidus Temperature (TL)	220 °C
Time (TL) Maintained Above TL	60-150 seconds
Peak Temp(Tp)	260 °C max.
Time (Tp) Within 5 °C of the Specified Classification Temperature (Tc)	25 seconds max.
Ramp-Down Rate (Tp to TL)	5 °C/second max.
Time 25 °C to Peak Temperature	10 minutes max.

Figure 16 : Pick and Place

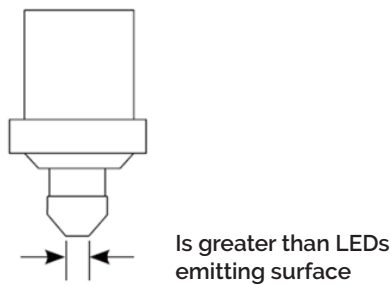

Note for Figure 16:

- When using a pick and place machine, choose a nozzle that has a larger diameter than the LED's emitting surface. Using a Pick-and-Place nozzle with a smaller diameter than the size of the LEDs emitting surface will cause damage and may also cause the LED to not illuminate.

Packaging

Figure 17: Emitter Reel Drawings

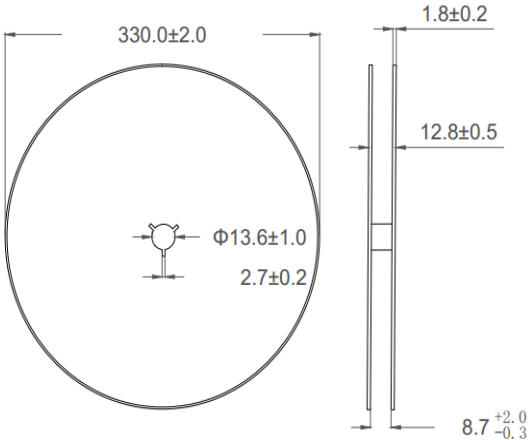

Note for Figure 17:

- 1. Drawings are not to scale. Drawing dimensions are in millimeters.

Figure 18: Emitter Tape Drawings

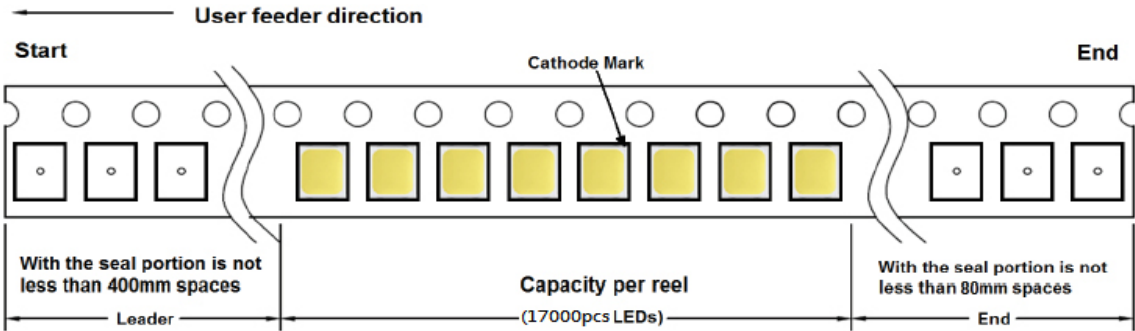
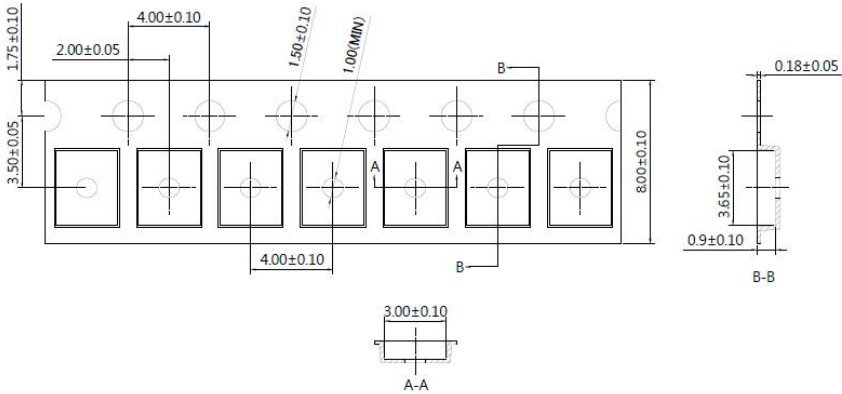

Note for Figure 18:

- 1. Drawings are not to scale. Drawing dimensions are in millimeters.

Packaging

Figure 19: SMD 2835 Packaging and Labeling

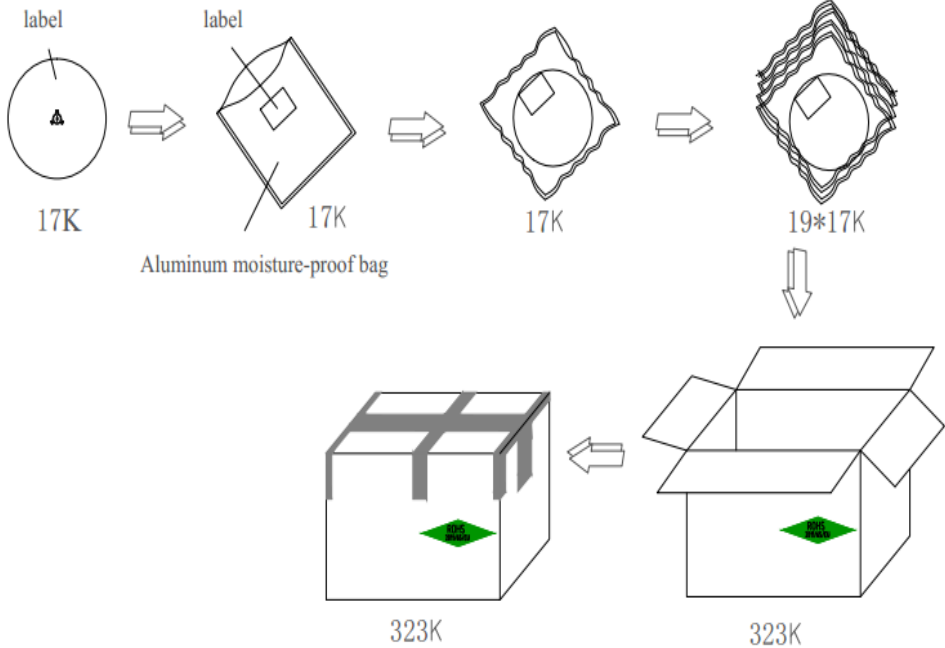

Note for Figure 19:
1. Drawings are not to scale.

Design Resources

Please contact your Bridgelux sales representative for assistance.

Precautions

CAUTION: CHEMICAL EXPOSURE HAZARD

Exposure to some chemicals commonly used in luminaire manufacturing and assembly can cause damage to the LED emitter. Please consult Bridgelux Application Note AN51 for additional information.

CAUTION: EYE SAFETY

Eye safety classification for the use of Bridgelux SMD LED emitter is in accordance with IEC specification EN62778: Application of IEC 62471 for the assessment of blue light hazard to light sources and luminaires are classified as Risk Group 1 when operated at or below the maximum drive current. Please use appropriate precautions. It is important that employees working with LEDs are trained to use them safely.

CAUTION: RISK OF BURN

Do not touch the SMD LED emitter during operation. Allow the emitter to cool for a sufficient period of time before handling. The SMD LED emitter may reach elevated temperatures such that could burn skin when touched.

Disclaimers

MINOR PRODUCT CHANGE POLICY

The rigorous qualification testing on products offered by Bridgelux provides performance assurance. Slight cosmetic changes that do not affect form, fit, or function may occur as Bridgelux continues product optimization.

CAUTION

CONTACT WITH LIGHT EMITTING SURFACE (LES)

Avoid any contact with the LES. Do not touch the LES of the emitter or apply stress to the LES (yellow phosphor resin area). Contact may cause damage to the emitter

Optics and reflectors must not be mounted in contact with the LES (yellow phosphor resin area).

STANDARD TEST CONDITIONS

Unless otherwise stated, LED emitter testing is performed at the nominal drive current.

About Bridgelux: Bridging Light and Life™

At Bridgelux, we help companies, industries and people experience the power and possibility of light. Since 2002, we've designed LED solutions that are high performing, energy efficient, cost effective and easy to integrate. Our focus is on light's impact on human behavior, delivering products that create better environments, experiences and returns—both experiential and financial. And our patented technology drives new platforms for commercial and industrial luminaires.

For more information about the company, please visit
bridgelux.com
twitter.com/Bridgelux
facebook.com/Bridgelux
linkedin.com/company/bridgelux-inc-_2
youtube.com/user/Bridgelux
WeChat ID: BridgeluxInChina



46430 Fremont Boulevard
Fremont, CA 94538 USA
Tel (925) 583-8400
www.bridgelux.com

© 2020 Bridgelux, Inc. Product specifications are subject to change without notice. Bridgelux and the Bridgelux stylized logo design are registered trademarks of Bridgelux, Inc. Thrive is a trademark of Bridgelux, Inc. All other trademarks are the property of their respective owners.