

THIS DOCUMENT IS THE PROPERTY OF KEYSTONE ELECTRONICS CORP. AND SHALL NOT BE REPRODUCED, DISTRIBUTED OR USED AS A BASIS FOR MANUFACTURE WITHOUT PRIOR WRITTEN PERMISSION FROM KEYSTONE ELECTRONICS CORP.

**MOUNTING DETAIL**

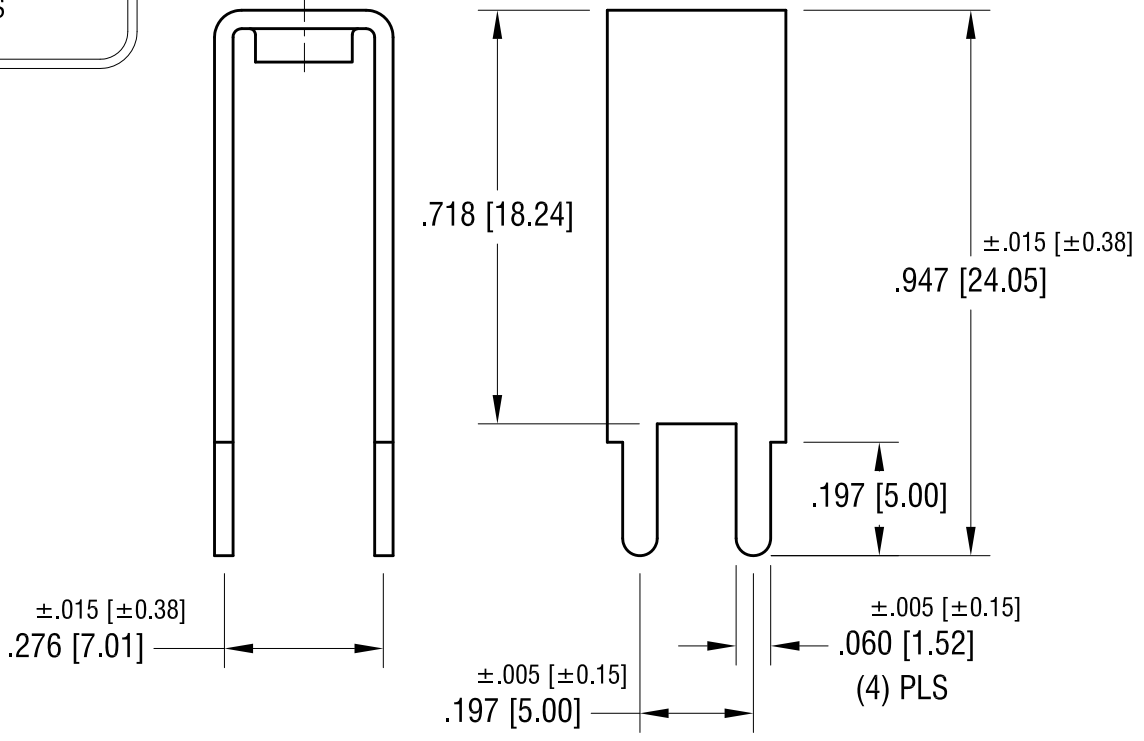
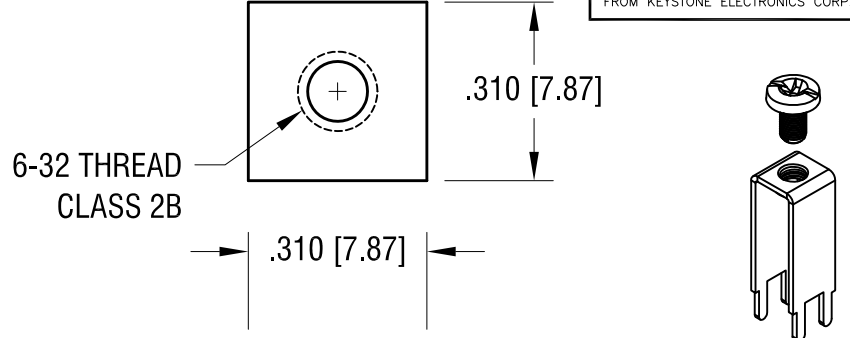
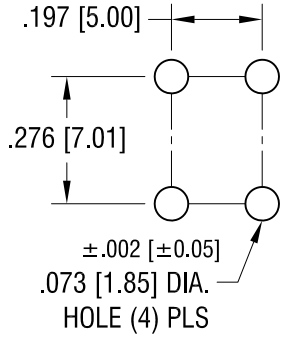

**EXTENDED PC SCREW TERMINAL WITH COLORED SCREW HEAD**

PART NO.	HEAD COLOR	PART NO.	HEAD COLOR
7697-2	RED	7697-5	BLUE
7697-3	BLACK	7697-6	GREEN
7697-4	WHITE	7697-7	YELLOW

**NOTE:**

**1. TERMINAL:**

MAT'L - .032 [0.81] TH'K BRASS, MATTE TIN PLATE  
 SCREW : ONE (1) 6-32 x 1/4 L., SUPPLIED LOOSE.  
 MAT'L - BRASS, NICKEL PLATE

**KEYSTONE ELECTRONICS CORP.**

www.keyelco.com • ASTORIA, N.Y. 11105-2017 • Tel (718) 956-8900

PART NAME  
 EXTENDED PC SCREW TERMINAL WITH COLORED SCREW HEAD

MATERIAL  
 AS NOTED

FINISH AS NOTED	DRN BY	BOONE	DATE	10.1.03
	APP'D	LN	SCALE	3X

TOLERANCES	INCH	[MM]	CODE	DWG NO.
DECIMAL	± .010	[± 0.25]	C	7697-2 - 7697-7
ANGULAR	± 1°			
UNLESS OTHERWISE SPECIFIED				

DATE	DESCRIPTION	REV.
7.14.09	CHANGE AS PER ECN 09-100	B
1.3.08	CHANGE AS PER ECN 08-028	A

# Mouser Electronics

Authorized Distributor

Click to View Pricing, Inventory, Delivery & Lifecycle Information:

[Keystone Electronics:](#)

[7697-6](#)