

THIS DOCUMENT IS THE PROPERTY OF KEYSTONE ELECTRONICS CORP. AND SHALL NOT BE REPRODUCED, DISTRIBUTED OR USED AS A BASIS FOR MANUFACTURE WITHOUT PRIOR WRITTEN PERMISSION FROM KEYSTONE ELECTRONICS CORP.

MOUNTING DETAIL

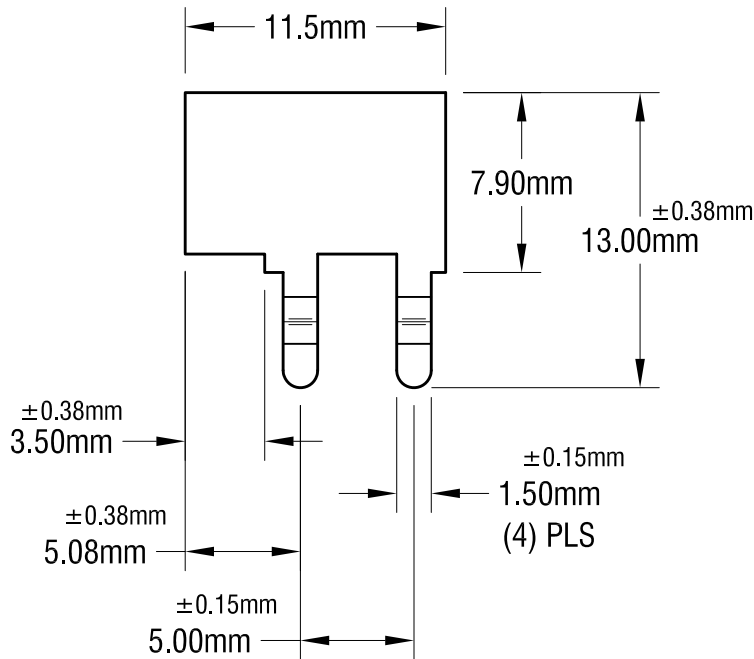
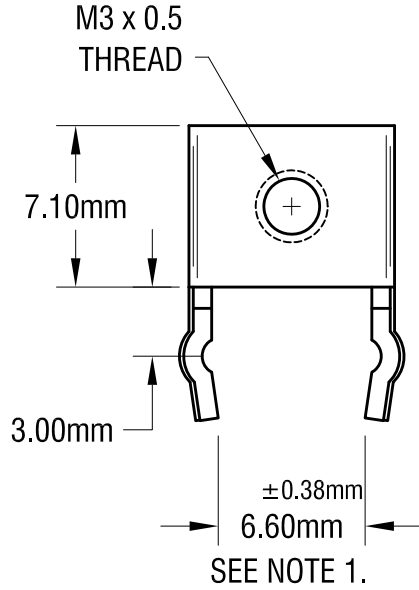
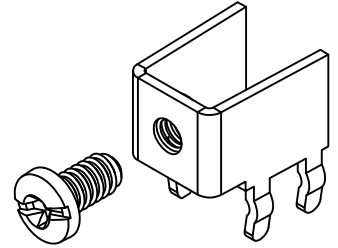
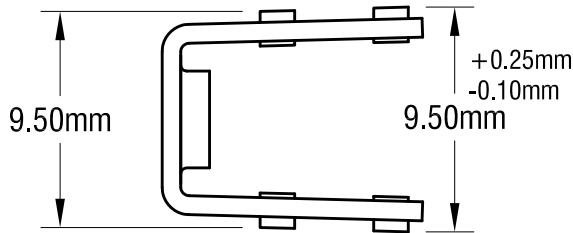
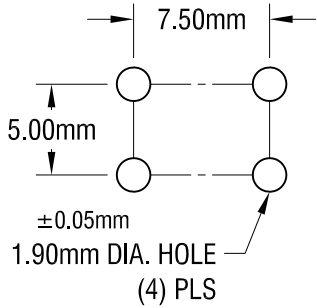

PC SCREW TERMINAL WITH COLORED SCREW HEAD

PART NO.	HEAD COLOR	PART NO.	HEAD COLOR
7689-2	RED	7689-5	BLUE
7689-3	BLACK	7689-6	GREEN
7689-4	WHITE	7689-7	YELLOW

NOTE:

1. TERMINAL:

MAT'L - 0.8mm TH'K BRASS, MATTE TIN PLATE

SCREW : ONE (1) M3 x 0.5 6.00mm L., SUPPLIED LOOSE.

MAT'L - BRASS, NICKEL PLATE

2. ALL DIMENSIONS ARE IN MILLIMETERS.

KEYSTONE ELECTRONICS CORP.

www.keyelco.com • ASTORIA, N.Y. 11105-2017 • Tel (718) 956-8900

PART NAME				PC METRIC SCREW TERMINAL			
MATERIAL				0.8mm TH'K BRASS			
FINISH		DRN BY		DATE		SCALE	
AS NOTED		NT		1.27.10		3X	
TOLERANCES		INCH		[MM]		CODE	
DECIMAL		±		[± 0.25]		C	
ANGULAR		± 1°		UNLESS OTHERWISE SPECIFIED		DWG NO.	
						7689-2 -7689-7	

DATE	DESCRIPTION	REV.

Mouser Electronics

Authorized Distributor

Click to View Pricing, Inventory, Delivery & Lifecycle Information:

[Keystone Electronics:](#)

[7689-5](#)