

u-blox 8 / u-blox M8

Receiver Description

Including Protocol Specification

Abstract

The Receiver Description Including Protocol Specification describes the firmware features, specifications and configuration for u-blox 8 / u-blox M8 high performance positioning modules. The Receiver Description provides an overview and conceptual details of the supported features.

The Protocol Specification describes the NMEA and RTCM protocols as well as the UBX protocol (version 15.00 up to 19.10, version 20.00 to 20.30, version 22.00 and version 23.00 to 23.01) and serves as a reference manual. It includes the Standard Precision GNSS, Time Sync, Time & Frequency Sync, High Precision GNSS, ADR and UDR products.

Document Information

Title	u-blox 8 / u-blox M8 Receiver Description		
Subtitle	Including Protocol Specification v15-20.30,22-23.01		
Document type	Manual		
Document number	UBX-13003221		
Revision and date	R12 <small>(c9f0122)</small>	28 April 2017	
Document status	Early Production Information		

Document status explanation

Objective Specification	Document contains target values. Revised and supplementary data will be published later.
Advance Information	Document contains data based on early testing. Revised and supplementary data will be published later.
Early Production Information	Document contains data from product verification. Revised and supplementary data may be published later.
Production Information	Document contains the final product specification.

This document applies to the following products:

Product name	Type number	Firmware version	Product category
CAM-M8C	CAM-M8C-0-10	SPG 3.01	Standard Precision GNSS
CAM-M8Q	CAM-M8Q-0-10	SPG 3.01	Standard Precision GNSS
EVA-M8M	EVA-M8M-0-10	SPG 3.01	Standard Precision GNSS
EVA-M8M	EVA-M8M-1-10	SPG 3.01	Standard Precision GNSS
EVA-M8Q	EVA-M8Q-0-10	SPG 3.01	Standard Precision GNSS
MAX-M8C	MAX-M8C-0-10	SPG 3.01	Standard Precision GNSS
MAX-M8Q	MAX-M8Q-0-10	SPG 3.01	Standard Precision GNSS
MAX-M8W	MAX-M8W-0-10	SPG 3.01	Standard Precision GNSS
NEO-M8M	NEO-M8M-0-10	SPG 3.01	Standard Precision GNSS
NEO-M8N	NEO-M8N-0-10	SPG 3.01	Standard Precision GNSS
NEO-M8Q	NEO-M8Q-0-10	SPG 3.01	Standard Precision GNSS
NEO-M8Q	NEO-M8Q-01A-10	SPG 3.01	Standard Precision GNSS
LEA-M8S	LEA-M8S-0-10	SPG 3.01	Standard Precision GNSS
SAM-M8Q	SAM-M8Q-0-10	SPG 3.01	Standard Precision GNSS
ZOE-M8G	ZOE-M8G-0-10	SPG 3.01	Standard Precision GNSS
EVA-8M	EVA-8M-0-10	SPG 3.01	Standard Precision GNSS
MAX-8C	MAX-8C-0-10	SPG 3.01	Standard Precision GNSS
MAX-8Q	MAX-8Q-0-10	SPG 3.01	Standard Precision GNSS

NEO-8Q	NEO-8Q-0-10	SPG 3.01	Standard Precision GNSS
NEO-M8P	NEO-M8P-0-10	HPG 1.40	High Precision GNSS
NEO-M8P	NEO-M8P-2-10	HPG 1.40	High Precision GNSS
EVA-M8E	EVA-M8E-0-11	UDR 1.00	Dead Reckoning
NEO-M8U	NEO-M8U-0-10	UDR 1.00	Dead Reckoning
NEO-M8T	NEO-M8T-0-10	TIM 1.10	Timing
LEA-M8T	LEA-M8T-0-10	TIM 1.10	Timing
LEA-M8F	LEA-M8F-0-00	FTS 1.01	Timing

u-blox reserves all rights to this document and the information contained herein. Products, names, logos and designs described herein may in whole or in part be subject to intellectual property rights. Reproduction, use, modification or disclosure to third parties of this document or any part thereof without the express permission of u-blox is strictly prohibited.

The information contained herein is provided "as is" and u-blox assumes no liability for the use of the information. No warranty, either express or implied, is given, including but not limited, with respect to the accuracy, correctness, reliability and fitness for a particular purpose of the information. This document may be revised by u-blox at any time. For most recent documents, please visit www.u-blox.com.

Copyright © 2017, u-blox AG.

u-blox® is a registered trademark of u-blox Holding AG in the EU and other countries. ARM® is the registered trademark of ARM Limited in the EU and other countries.

Table of Contents

Preface	1
1 Document Overview	1
2 Firmware and Protocol Versions	1
2.1 How to determine the version and the location of the firmware	1
2.1.1 Decoding the boot screen (for Protocol Version 17 and below)	1
2.1.2 Decoding the boot screen (for Protocol Version 18 and above)	3
2.1.3 Decoding the output of UBX-MON-VER (for Protocol Version 17 and below)	4
2.1.4 Decoding the output of UBX-MON-VER (for Protocol Version 18 and above)	6
2.2 How to determine the supported protocol version of the u-blox receiver	7
2.3 u-blox 8 / u-blox M8 Firmware and Supported Protocol Versions	7
Receiver Description	9
3 Receiver Configuration	9
3.1 Configuration Concept	9
3.2 Organization of the Configuration Sections	10
3.3 Permanent Configuration Storage Media	10
3.4 u-blox Receiver Default Configuration	11
3.5 Save-on-Shutdown Feature	11
4 Concurrent GNSS	12
4.1 GNSS Types	12
4.1.1 Major GNSS	12
4.1.2 Augmentation Systems	13
4.2 Configuration	13
4.2.1 Switching between GNSS	14
4.2.2 Configuring QZSS L1SAIF	14
5 SBAS Configuration Settings Description	14
5.1 SBAS (Satellite Based Augmentation Systems)	14
5.2 SBAS Features	16
5.3 SBAS Configuration	17
6 IMES Description	18
6.1 IMES Features	18
7 Navigation Configuration Settings Description	18
7.1 Platform settings	18
7.2 Navigation Input Filters	19
7.3 Navigation Output Filters	20
7.3.1 Speed (3-D) Low-pass Filter	20
7.3.2 Course over Ground Low-pass Filter	20
7.3.3 Low-speed Course Over Ground Filter	21
7.4 Static Hold	21
7.5 Freezing the Course Over Ground	21

7.6	Degraded Navigation.....	21
7.6.1	2D Navigation.....	21
7.7	Geodetic Coordinate Systems and Ellipsoids.....	22
8	Clocks and Time.....	22
8.1	Receiver Local Time.....	22
8.2	Navigation Epochs.....	23
8.3	iTOW Timestamps	24
8.4	GNSS Times	24
8.5	Time Validity.....	24
8.6	UTC Representation	25
8.7	Leap Seconds	25
8.8	Real Time Clock	25
8.9	Date.....	26
8.9.1	GPS-only Date Resolution	26
9	Broadcast Navigation Data.....	26
9.1	Parsing Navigation Data Subframes	27
9.2	GPS	27
9.3	GLONASS.....	27
9.4	BeiDou	28
9.5	Galileo.....	28
9.6	SBAS	29
9.7	QZSS	30
9.8	IMES	30
9.9	Summary	30
10	Serial Communication Ports Description.....	31
10.1	TX-ready indication.....	31
10.2	Extended TX timeout.....	32
10.3	UART Ports.....	32
10.4	USB Port	32
10.5	DDC Port	33
10.5.1	Read Access.....	33
10.5.2	Write Access.....	35
10.6	SPI Port.....	36
10.6.1	Maximum SPI clock speed.....	36
10.6.2	Read Access.....	36
10.6.3	Back-To-Back Read and Write Access.....	36
10.7	How to change between protocols.....	37
11	Multiple GNSS Assistance (MGA).....	37
11.1	Introduction.....	37
11.2	Assistance Data.....	37
11.3	AssistNow Online	38
11.3.1	Host Software.....	39
11.3.2	AssistNow Online Sequence	40

11.3.3	Flow Control	40
11.3.4	Authorization	40
11.3.5	Service Parameters	40
11.3.6	Multiple Servers	42
11.4	AssistNow Offline	42
11.4.1	Service Parameters	43
11.4.2	Authorization	44
11.4.3	Multiple Servers	44
11.4.4	Time, Position and Almanac	44
11.4.5	Flash-based AssistNow Offline	44
11.4.6	Host-based AssistNow Offline	45
11.5	Preserving Information During Power-off	46
11.6	AssistNow Autonomous	46
11.6.1	Introduction	46
11.6.2	Concept	47
11.6.3	Interface	48
11.6.4	Benefits and Drawbacks	49
12	Power Management	50
12.1	Continuous Mode	51
12.2	Power Save Mode	51
12.2.1	Operation	51
12.2.2	Configuration	54
12.2.3	Features	57
12.2.4	Examples	58
12.3	Peak current settings	59
12.4	Power On/Off command	59
12.5	EXTINT pin control when Power Save Mode is not active	59
12.6	Measurement and navigation rate with Power Save Mode	59
12.7	Power Mode Setup	60
13	Forcing a Receiver Reset	60
14	Receiver Status Monitoring	61
14.1	Input/Output system	61
14.2	Jamming/Interference Indicator	62
14.3	Jamming/Interference Monitor (ITFM)	62
15	Spoofing Detection	63
15.1	Introduction	63
15.2	Scope	63
16	Signal Attenuation Compensation	63
17	Remote Inventory	63
17.1	Description	63
17.2	Usage	63
18	Time pulse	64
18.1	Introduction	64

18.2	Recommendations.....	64
18.3	GNSS time bases	65
18.4	Time pulse configuration.....	66
18.5	Configuring time pulse with UBX-CFG-TP5	66
18.5.1	Example 1	67
18.5.2	Example 2	68
19	Timemark.....	68
20	Odometer	69
20.1	Introduction.....	69
20.2	Odometer Output	69
20.3	Odometer Configuration.....	70
20.4	Resetting the Odometer	70
21	Logging.....	70
21.1	Introduction.....	70
21.2	Setting the logging system up	71
21.3	Information about the log	71
21.4	Recording.....	72
21.5	Retrieval.....	73
21.6	Command message acknowledgement	73
22	Geofencing	74
22.1	Introduction.....	74
22.2	Interface.....	74
22.3	Geofence state evaluation.....	74
22.4	Using a PIO for Geofence State Output.....	75
23	Host Interface Signature Description	75
23.1	Introduction.....	75
23.2	Configuring the Fixed Seed and Register Messages	75
23.3	Configuring the Dynamic Seed	75
23.4	Parsing the Signature.....	76
23.5	Calculate the Hash	76
24	Time Mode Configuration	76
24.1	Introduction.....	76
24.2	Fixed Position	76
24.3	Survey-in	77
25	Time & Frequency Sync (FTS).....	77
25.1	Introduction.....	77
25.2	Example use cases	78
25.2.1	Stand-alone synchronization system.....	79
25.2.2	Oscillator control via host.....	79
25.2.3	Oscillator control via directly-connected DAC.....	80
25.2.4	External (coherent) PPS.....	81
25.3	Synchronization Manager Concept.....	81
25.4	Oscillator and source specification.....	83

25.5	Calibration	83
25.6	FTS device Output and Top Of Second (TOS) message	84
25.7	Message transmission time slot reservations on host interfaces.....	85
25.7.1	Example setup	86
26	RTK Mode Configuration.....	86
26.1	Reference Station Mode Configuration	87
26.2	Rover Mode Configuration.....	87
26.3	Moving Baseline RTK Configuration.....	87
26.3.1	MB Reference Configuration.....	88
26.3.2	MB Rover Configuration.....	88
26.3.3	Expected Performance	88
27	Automotive Dead Reckoning (ADR)	89
27.1	Introduction.....	89
27.2	ADR System Configuration	89
27.2.1	Enabling/Disabling Fusion Filter	89
27.2.2	Recommended Configuration	89
27.3	Operation	89
27.3.1	Fusion Filter Modes	89
27.3.2	Accelerated Initialization and Calibration Procedure.....	90
27.3.3	Navigation Output	90
27.3.4	Sensor Data Types	93
27.3.5	Raw Sensor Data Output	94
27.3.6	Receiver Startup and Shutdown.....	95
28	Untethered Dead Reckoning (UDR)	95
28.1	Introduction.....	95
28.2	UDR System Configuration	95
28.2.1	Enabling/Disabling Fusion Filter.....	95
28.2.2	Recommended Configuration	95
28.3	Operation	95
28.3.1	Fusion Filter Modes.....	95
28.3.2	Accelerated Initialization and Calibration Procedure.....	96
28.3.3	Navigation Output	97
28.3.4	Sensor Data Types	99
28.3.5	Raw Sensor Data Output	100
28.3.6	Receiver Startup and Shutdown.....	100
29	High Navigation Rate (HNR).....	101
29.1	Introduction.....	101
29.2	Configuration	101
	Protocol Specification	103
30	NMEA Protocol	103
30.1	Protocol Overview.....	103
30.1.1	Message Format	103
30.1.2	Talker ID.....	103

30.1.3	Protocol Configuration	104
30.1.4	Satellite Numbering	105
30.1.5	Latitude and Longitude Format	106
30.1.6	Position Fix Flags	106
30.1.7	Multi-GNSS considerations	107
30.1.8	Output of Invalid/Unknown Data	108
30.1.9	Messages Overview	108
30.2	Standard Messages.....	110
30.2.1	DTM.....	110
30.2.2	GBQ	111
30.2.3	GBS.....	111
30.2.4	GGA.....	112
30.2.5	GLL	114
30.2.6	GLQ	115
30.2.7	GNQ.....	115
30.2.8	GNS.....	116
30.2.9	GPQ	117
30.2.10	GRS.....	117
30.2.11	GSA.....	118
30.2.12	GST	119
30.2.13	GSV.....	120
30.2.14	RMC.....	121
30.2.15	TXT	122
30.2.16	VLW.....	123
30.2.17	VTG.....	124
30.2.18	ZDA	125
30.3	PUBX Messages.....	126
30.3.1	CONFIG (PUBX,41)	126
30.3.2	POSITION (PUBX,00)	127
30.3.3	RATE (PUBX,40)	128
30.3.4	SVSTATUS (PUBX,03)	129
30.3.5	TIME (PUBX,04).....	130
31	UBX Protocol.....	131
31.1	UBX Protocol Key Features	131
31.2	UBX Packet Structure	131
31.3	UBX Payload Definition Rules	132
31.3.1	Structure Packing	132
31.3.2	Reserved Elements	132
31.3.3	Undefined Values.....	132
31.3.4	Message Naming	132
31.3.5	Number Formats.....	132
31.4	UBX Checksum.....	133
31.5	UBX Message Flow	133

31.5.1	Acknowledgement.....	133
31.5.2	Polling Mechanism.....	134
31.6	UBX Satellite Numbering.....	134
31.7	UBX Class IDs	134
31.8	UBX Messages Overview.....	136
31.9	UBX-ACK (0x05).....	142
31.9.1	UBX-ACK-ACK (0x05 0x01).....	142
31.9.2	UBX-ACK-NAK (0x05 0x00)	142
31.10	UBX-AID (0x0B).....	143
31.10.1	UBX-AID-ALM (0x0B 0x30).....	143
31.10.2	UBX-AID-AOP (0x0B 0x33)	144
31.10.3	UBX-AID-EPH (0x0B 0x31)	146
31.10.4	UBX-AID-HUI (0x0B 0x02)	148
31.10.5	UBX-AID-INI (0x0B 0x01)	150
31.11	UBX-CFG (0x06)	153
31.11.1	UBX-CFG-ANT (0x06 0x13)	153
31.11.2	UBX-CFG-CFG (0x06 0x09).....	154
31.11.3	UBX-CFG-DAT (0x06 0x06)	156
31.11.4	UBX-CFG-DGNSS (0x06 0x70).....	157
31.11.5	UBX-CFG-DOSC (0x06 0x61)	158
31.11.6	UBX-CFG-DYNSEED (0x06 0x85)	159
31.11.7	UBX-CFG-ESRC (0x06 0x60)	160
31.11.8	UBX-CFG-FIXSEED (0x06 0x84).....	161
31.11.9	UBX-CFG-GEOFENCE (0x06 0x69)	162
31.11.10	UBX-CFG-GNSS (0x06 0x3E).....	163
31.11.11	UBX-CFG-HNR (0x06 0x5C).....	165
31.11.12	UBX-CFG-INF (0x06 0x02)	166
31.11.13	UBX-CFG-ITFM (0x06 0x39)	167
31.11.14	UBX-CFG-LOGFILTER (0x06 0x47)	168
31.11.15	UBX-CFG-MSG (0x06 0x01).....	170
31.11.16	UBX-CFG-NAV5 (0x06 0x24).....	171
31.11.17	UBX-CFG-NAVX5 (0x06 0x23)	173
31.11.18	UBX-CFG-NMEA (0x06 0x17).....	177
31.11.19	UBX-CFG-ODO (0x06 0x1E)	184
31.11.20	UBX-CFG-PM2 (0x06 0x3B).....	185
31.11.21	UBX-CFG-PMS (0x06 0x86)	189
31.11.22	UBX-CFG-PRT (0x06 0x00)	190
31.11.23	UBX-CFG-PWR (0x06 0x57).....	201
31.11.24	UBX-CFG-RATE (0x06 0x08).....	201
31.11.25	UBX-CFG-RINV (0x06 0x34)	202
31.11.26	UBX-CFG-RST (0x06 0x04)	203
31.11.27	UBX-CFG-RXM (0x06 0x11)	204
31.11.28	UBX-CFG-SBAS (0x06 0x16).....	205

31.11.29	UBX-CFG-SMGR (0x06 0x62)	207
31.11.30	UBX-CFG-TMODE2 (0x06 0x3D)	209
31.11.31	UBX-CFG-TMODE3 (0x06 0x71)	211
31.11.32	UBX-CFG-TP5 (0x06 0x31)	212
31.11.33	UBX-CFG-TXSLOT (0x06 0x53)	216
31.11.34	UBX-CFG-USB (0x06 0x1B)	217
31.12	UBX-ESF (0x10)	219
31.12.1	UBX-ESF-INS (0x10 0x15)	219
31.12.2	UBX-ESF-MEAS (0x10 0x02)	220
31.12.3	UBX-ESF-RAW (0x10 0x03)	221
31.12.4	UBX-ESF-STATUS (0x10 0x10)	222
31.13	UBX-HNR (0x28)	225
31.13.1	UBX-HNR-PVT (0x28 0x00)	225
31.14	UBX-INF (0x04)	227
31.14.1	UBX-INF-DEBUG (0x04 0x04)	227
31.14.2	UBX-INF-ERROR (0x04 0x00)	227
31.14.3	UBX-INF-NOTICE (0x04 0x02)	228
31.14.4	UBX-INF-TEST (0x04 0x03)	228
31.14.5	UBX-INF-WARNING (0x04 0x01)	229
31.15	UBX-LOG (0x21)	230
31.15.1	UBX-LOG-CREATE (0x21 0x07)	230
31.15.2	UBX-LOG-ERASE (0x21 0x03)	231
31.15.3	UBX-LOG-FINDTIME (0x21 0x0E)	231
31.15.4	UBX-LOG-INFO (0x21 0x08)	232
31.15.5	UBX-LOG-RETRIEVEPOSEXTRA (0x21 0x0f)	234
31.15.6	UBX-LOG-RETRIEVEPOS (0x21 0x0b)	235
31.15.7	UBX-LOG-RETRIEVESTRING (0x21 0x0d)	236
31.15.8	UBX-LOG-RETRIEVE (0x21 0x09)	236
31.15.9	UBX-LOG-STRING (0x21 0x04)	237
31.16	UBX-MGA (0x13)	238
31.16.1	UBX-MGA-ACK (0x13 0x60)	238
31.16.2	UBX-MGA-ANO (0x13 0x20)	239
31.16.3	UBX-MGA-BDS (0x13 0x03)	239
31.16.4	UBX-MGA-DBD (0x13 0x80)	244
31.16.5	UBX-MGA-FLASH (0x13 0x21)	245
31.16.6	UBX-MGA-GAL (0x13 0x02)	247
31.16.7	UBX-MGA-GLO (0x13 0x06)	250
31.16.8	UBX-MGA-GPS (0x13 0x00)	253
31.16.9	UBX-MGA-INI (0x13 0x40)	258
31.16.10	UBX-MGA-QZSS (0x13 0x05)	263
31.17	UBX-MON (0x0A)	267
31.17.1	UBX-MON-GNSS (0x0A 0x28)	267
31.17.2	UBX-MON-HW2 (0x0A 0x0B)	269

31.17.3	UBX-MON-HW (0x0A 0x09)	270
31.17.4	UBX-MON-IO (0x0A 0x02)	271
31.17.5	UBX-MON-MSGPP (0x0A 0x06)	272
31.17.6	UBX-MON-PATCH (0x0A 0x27)	272
31.17.7	UBX-MON-RXBUF (0x0A 0x07)	274
31.17.8	UBX-MON-RXR (0x0A 0x21)	274
31.17.9	UBX-MON-SMGR (0x0A 0x2E)	275
31.17.10	UBX-MON-TXBUF (0x0A 0x08)	278
31.17.11	UBX-MON-VER (0x0A 0x04)	279
31.18	UBX-NAV (0x01)	280
31.18.1	UBX-NAV-AOPSTATUS (0x01 0x60)	280
31.18.2	UBX-NAV-ATT (0x01 0x05)	281
31.18.3	UBX-NAV-CLOCK (0x01 0x22)	281
31.18.4	UBX-NAV-DGPS (0x01 0x31)	282
31.18.5	UBX-NAV-DOP (0x01 0x04)	283
31.18.6	UBX-NAV-EOE (0x01 0x61)	284
31.18.7	UBX-NAV-GEOFENCE (0x01 0x39)	284
31.18.8	UBX-NAV-HPPOSECEF (0x01 0x13)	285
31.18.9	UBX-NAV-HPPOSLLH (0x01 0x14)	286
31.18.10	UBX-NAV-ODO (0x01 0x09)	287
31.18.11	UBX-NAV-ORB (0x01 0x34)	287
31.18.12	UBX-NAV-POSECEF (0x01 0x01)	290
31.18.13	UBX-NAV-POSLLH (0x01 0x02)	290
31.18.14	UBX-NAV-PVT (0x01 0x07)	291
31.18.15	UBX-NAV-RELPOSNED (0x01 0x3C)	294
31.18.16	UBX-NAV-RESETODO (0x01 0x10)	296
31.18.17	UBX-NAV-SAT (0x01 0x35)	296
31.18.18	UBX-NAV-SBAS (0x01 0x32)	298
31.18.19	UBX-NAV-SOL (0x01 0x06)	299
31.18.20	UBX-NAV-STATUS (0x01 0x03)	301
31.18.21	UBX-NAV-SVININFO (0x01 0x30)	303
31.18.22	UBX-NAV-SVIN (0x01 0x3B)	305
31.18.23	UBX-NAV-TIMEBDS (0x01 0x24)	306
31.18.24	UBX-NAV-TIMEGAL (0x01 0x25)	307
31.18.25	UBX-NAV-TIMEGLO (0x01 0x23)	308
31.18.26	UBX-NAV-TIMEGPS (0x01 0x20)	309
31.18.27	UBX-NAV-TIMELS (0x01 0x26)	310
31.18.28	UBX-NAV-TIMEUTC (0x01 0x21)	312
31.18.29	UBX-NAV-VELECEF (0x01 0x11)	313
31.18.30	UBX-NAV-VELNED (0x01 0x12)	314
31.19	UBX-RXM (0x02)	315
31.19.1	UBX-RXM-IMES (0x02 0x61)	315
31.19.2	UBX-RXM-MEASX (0x02 0x14)	317

31.19.3	UBX-RXM-PMREQ (0x02 0x41).....	319
31.19.4	UBX-RXM-RAWX (0x02 0x15)	321
31.19.5	UBX-RXM-RLM (0x02 0x59).....	327
31.19.6	UBX-RXM-RTCM (0x02 0x32)	328
31.19.7	UBX-RXM-SFRBX (0x02 0x13).....	329
31.19.8	UBX-RXM-SVSI (0x02 0x20).....	330
31.20	UBX-SEC (0x27)	333
31.20.1	UBX-SEC-SIGN (0x27 0x01)	333
31.20.2	UBX-SEC-UNIQID (0x27 0x03)	333
31.21	UBX-TIM (0x0D)	334
31.21.1	UBX-TIM-DOSC (0x0D 0x11).....	334
31.21.2	UBX-TIM-FCHG (0x0D 0x16).....	334
31.21.3	UBX-TIM-HOC (0x0D 0x17)	335
31.21.4	UBX-TIM-SMEAS (0x0D 0x13)	336
31.21.5	UBX-TIM-SVIN (0x0D 0x04)	338
31.21.6	UBX-TIM-TM2 (0x0D 0x03).....	339
31.21.7	UBX-TIM-TOS (0x0D 0x12)	340
31.21.8	UBX-TIM-TP (0x0D 0x01).....	342
31.21.9	UBX-TIM-VCOCAL (0x0D 0x15)	344
31.21.10	UBX-TIM-VERFY (0x0D 0x06)	346
31.22	UBX-UPD (0x09).....	347
31.22.1	UBX-UPD-SOS (0x09 0x14)	347
32	RTCM Protocol	350
32.1	RTCM2.....	350
32.1.1	Introduction.....	350
32.1.2	Supported Messages	350
32.1.3	Configuration	350
32.1.4	Output	350
32.1.5	Restrictions	351
32.1.6	Reference.....	351
32.2	RTCM3.....	351
32.2.1	Introduction.....	351
32.2.2	Supported Messages	351
32.2.3	u-blox Proprietary RTCM Messages.....	352
32.2.4	Configuration	353
32.2.5	Output	353
32.2.6	Reference.....	354
Appendix	355
A	Satellite Numbering	355
B	u-blox 8 / u-blox M8 Default Settings	355
B.1	Antenna Supervisor Settings (UBX-CFG-ANT)	355
B.2	Datum Settings (UBX-CFG-DAT)	355
B.3	GNSS System Settings (UBX-CFG-GNSS)	356

B.4	INF Messages Settings (UBX-CFG-INF)	356
B.4.1	UBX Protocol	356
B.4.2	NMEA Protocol	357
B.5	Jammer/Interference Monitor Settings (UBX-CFG-ITFM)	357
B.6	Logging Settings (UBX-CFG-LOGFILTER)	357
B.7	Navigation Settings (UBX-CFG-NAV5)	357
B.8	Navigation Settings (UBX-CFG-NAVX5)	358
B.9	NMEA Protocol Settings (UBX-CFG-NMEA)	359
B.10	Odometer Settings (UBX-CFG-ODO)	360
B.11	Power Management 2 Configuration (UBX-CFG-PM2)	360
B.12	Port Configuration (UBX-CFG-PRT)	361
B.12.1	UART Port Configuration	361
B.12.2	USB Port Configuration	362
B.12.3	SPI Port Configuration	362
B.12.4	DDC Port Configuration	362
B.13	Output Rate Settings (UBX-CFG-RATE)	363
B.14	Remote Inventory Settings (UBX-CFG-RINV)	363
B.15	Receiver Manager Configuration Settings (UBX-CFG-RXM)	363
B.16	SBAS Configuration Settings (UBX-CFG-SBAS)	363
B.17	Timepulse Settings (UBX-CFG-TP5)	364
B.18	USB Settings (UBX-CFG-USB)	364
Related Documents		366
Overview		366
Revision History		367
Contact		368
u-blox Offices		368

Preface

1 Document Overview

The Receiver Description Including Protocol Specification is an important resource for integrating and configuring u-blox receivers. This document has a modular structure and it is not necessary to read it from the beginning to the end. There are two main sections: The Receiver Description and the Protocol Specification.

The *Receiver Description* describes the software aspects of system features and configuration of u-blox receivers. The Receiver Description is structured according to areas of functionality, with links provided to the corresponding NMEA and UBX messages, which are described in the Protocol Specification.

The *Protocol Specification* is a reference describing the messages used by the u-blox receiver and is organized by the specific NMEA, UBX, and RTCM messages.



This document provides general information on u-blox receivers. Some information might not apply to certain products. Refer to the product Data Sheet and/or Hardware Integration Manual for possible restrictions or limitations.

2 Firmware and Protocol Versions

The protocol version defines a set of messages that are applicable across various u-blox products. Each firmware used by a u-blox receiver supports a specific protocol version, which is not configurable.

The following sections will explain how to decode the shown information to get the firmware and the protocol version.

2.1 How to determine the version and the location of the firmware

The u-blox receiver can run a firmware from two different locations:

- Internal ROM
- External Flash memory

The location and the version of the currently running firmware can be found in the boot screen or in the UBX-MON-VER message.

For firmware supporting [Protocol Version 17 and below](#):

- [Boot screen, Protocol Version 17 and below](#)
- [UBX-MON-VER, Protocol Version 17 and below](#)

For firmware supporting [Protocol Version 18 and above](#):

- [Boot screen, Protocol Version 18 and above](#)
- [UBX-MON-VER, Protocol Version 18 and above](#)

2.1.1 Decoding the boot screen (for Protocol Version 17 and below)

Boot screen for a u-blox receiver running from ROM:

```

Text Console
??:??:?? $GNTXT,01,01,02,u-blox AG - www.u-blox.com*4E
??:??:?? $GNTXT,01,01,02,Hw UBX-M80xx 00080000 *43
??:??:?? $GNTXT,01,01,02,ROM CORE 2.01 (75331) Oct 29 2013 13:28:17*4A
??:??:?? $GNTXT,01,01,02,PROTVR 15.00*01
??:??:?? $GNTXT,01,01,02,GNSS OTP: GPS GLO, SEL: GPS GLO*67
??:??:?? $GNTXT,01,01,02,ANTSUPERV=AC SD PDoS SR*3E
??:??:?? $GNTXT,01,01,02,ANTSTATUS=DONTKNOW*2D
??:??:?? $GNTXT,01,01,02,LLC FFFFFFFF-FF7F7C3F-FFFFFFF96-FFFFFFF79*41
??:??:?? $GNTXT,01,01,02,RFO dev ok*04
    
```

Boot screen for a u-blox receiver running from Flash:

```

Text Console
07:24:13 $GNTXT,01,01,02,u-blox AG - www.u-blox.com*4E
07:24:13 $GNTXT,01,01,02,Hw UBX-M80xx 00080000 *43
07:24:13 $GNTXT,01,01,02,EXT CORE 2.01 (75350) Oct 29 2013 16:15:41*5C
07:24:13 $GNTXT,01,01,02,ROM BASE 2.01 (75331) Oct 29 2013 13:28:17*44
07:24:13 $GNTXT,01,01,02,PROTVR 15.00*01
07:24:13 $GNTXT,01,01,02,GNSS OTP: GPS GLO, SEL: GPS GLO*67
07:24:13 $GNTXT,01,01,02,ANTSUPERV=AC SD PDoS SR*3E
07:24:13 $GNTXT,01,01,02,ANTSTATUS=DONTKNOW*2D
07:24:13 $GNTXT,01,01,02,FIS 0xEF4015 (100111) found*13
07:24:13 $GNTXT,01,01,02,LLC FFFFFFFF-FFFFFFFED-FFFFFFF79-FFFFFFF69*3E
07:24:13 $GNTXT,01,01,02,RFO dev ok*04
    
```



Not every line is output by every u-blox receiver in the boot screen. This depends on the product, the firmware location and the firmware version.

Possible lines in the boot screen and their meanings:

Entry	Description
u-blox AG - www.u-blox.com	Start of the boot screen
HW UBX-M80xx 00080000	Hardware version of the u-blox receiver (u-blox M8 receiver)
ROM CORE 2.01 (75331) Oct 29 2013 13:28:17	Firmware version 2.01 running from ROM (revision number) compilation date/time
EXT CORE 2.01 (75350) Oct 29 2013 16:15:41	Firmware version 2.01 running from Flash (revision number) compilation date/time
ROM BASE 2.01 (75331) Oct 29 2013 13:28:17	Underlying firmware version 2.01 in ROM (revision number) compilation date/time
PROTVR 15.00	Supported protocol version
GNSS OTP: GPS GLO, SEL: GPS GLO	Default Major GNSS selection. Current Major GNSS selection.
ANTSUPERV=AC SD PDoS SR	Configuration of the Antenna supervisor where AC: Active Antenna Control enabled SD: Short Circuit Detection enabled OD: Open Circuit Detection enabled PDoS: Short Circuit Power Down Logic enabled SR: Automatic Recovery from Short state
LLC FFFFFFFF-FF7F7C3F- FFFFFFF96-FFFFFFF79	Low-level configuration of the u-blox receiver.
FIS 0xEF4015 (100111) found	Flash Information Structure (FIS) file for Flash memory with JEDEC 0xEF4015 found in the external flash memory. Revision number of the file is indicated in brackets.

Possible lines in the boot screen and their meanings: continued

Entry	Description
RF0 dev ok	RF channel 0 configured correctly.

The line containing the `CORE` indicates which version of the firmware is currently running. The firmware is running either from ROM (indicated with `ROM CORE`) or from external Flash memory (indicated with `EXT CORE`).

The line containing the `CORE` is called **firmware string** in the rest of the document.

2.1.2 Decoding the boot screen (for Protocol Version 18 and above)

Boot screen for a u-blox receiver running from ROM:

```

09:06:40 $GNTXT,01,01,02,u-blox AG - www.u-blox.com*4E
09:06:40 $GNTXT,01,01,02,HW UBX-M8030 00080000*60
09:06:40 $GNTXT,01,01,02,ROM CORE 3.01 (107888)*2B
09:06:40 $GNTXT,01,01,02,FWVER=SPG 3.01*46
09:06:40 $GNTXT,01,01,02,PROTVR=18.00*11
09:06:40 $GNTXT,01,01,02,GPS;GLO;GAL;BDS*77
09:06:40 $GNTXT,01,01,02,SBAS;IMES;QZSS*49
09:06:40 $GNTXT,01,01,02,GNSS OTP=GPS;GLO*37
09:06:40 $GNTXT,01,01,02,LLC=FFFFFFFF-FFFFFFFF-FFFFFFFF-FFFFFFFF-FFCFFFFFF*28
09:06:40 $GNTXT,01,01,02,ANTSUPERV=AC SD PDoS SR*3E
09:06:40 $GNTXT,01,01,02,ANTSTATUS=DONTKNOW*2D
09:06:40 $GNTXT,01,01,02,PF=3FF*4B
    
```

Boot screen for a u-blox receiver running from Flash:

```

09:15:59 $GNTXT,01,01,02,u-blox AG - www.u-blox.com*4E
09:15:59 $GNTXT,01,01,02,HW UBX-M8030 00080000*60
09:15:59 $GNTXT,01,01,02,EXT CORE 3.01 (107900)*33
09:15:59 $GNTXT,01,01,02,ROM BASE 3.01 (107888)*25
09:15:59 $GNTXT,01,01,02,FWVER=SPG 3.01*46
09:15:59 $GNTXT,01,01,02,PROTVR=18.00*11
09:15:59 $GNTXT,01,01,02,MOD=NEO-M8N-0*67
09:15:59 $GNTXT,01,01,02,FIS=0xEF4015 (100111)*58
09:15:59 $GNTXT,01,01,02,GPS;GLO;GAL;BDS*77
09:15:59 $GNTXT,01,01,02,SBAS;IMES;QZSS*49
09:15:59 $GNTXT,01,01,02,GNSS OTP=GPS;GLO*37
09:15:59 $GNTXT,01,01,02,LLC=FFFFFFFF-FFFFFEC-FFFFFFFF-FFFFFFBF-FFFFFF68*21
09:15:59 $GNTXT,01,01,02,ANTSUPERV=AC SD PDoS SR*3E
09:15:59 $GNTXT,01,01,02,ANTSTATUS=DONTKNOW*2D
09:15:59 $GNTXT,01,01,02,PF=3FB*4F
    
```

Not every line is output by every u-blox receiver in the boot screen. This depends on the product, the firmware location and the firmware version.

Possible lines in the boot screen and their meanings:

Entry	Description
u-blox AG - www.u-blox.com	Start of the boot screen
HW UBX-M8030 00800000	Hardware version of the u-blox receiver (u-blox M8 receiver)
HW UBX-G8020 00800000	Hardware version of the u-blox receiver (u-blox 8 receiver)
ROM CORE 3.01 (107888)	Firmware version 3.01 running from ROM (revision number)
EXT CORE 3.01 (107900)	Firmware version 3.01 running from Flash (revision number)

Possible lines in the boot screen and their meanings: continued

Entry	Description
ROM BASE 3.01 (107888)	Underlying firmware version 3.01 in ROM (revision number)
FWVER=SPG 3.01	Firmware of product category and version where SPG: Firmware of Standard Precision GNSS product HPG: Firmware of High Precision GNSS product ADR: Firmware of ADR product UDR: Firmware of UDR product TIM: Firmware of Time Sync product FTS: Firmware of Time & Frequency Sync product
PROTVER=18.00	Supported protocol version
MOD=NEO-M8N-0	Module identification. Set in production.
FIS=0xEF4015 (100111)	Flash Information Structure (FIS) file for Flash memory with JEDEC 0xEF4015 found in the external flash memory. Revision number of the file is indicated in brackets.
GPS;GLO;GAL;BDS	Supported Major GNSS .
SBAS;IMES;QZSS	Supported Augmentation systems .
GNSS OTP=GPS;GLO	Default Major GNSS selection.
LLC FFFFFFFF-FFFFFFFF-FFFFFFFF-FFCFFFFFFF	Low-level configuration of the u-blox receiver.
ANTSUPERV=AC SD PDoS SR	Configuration of the Antenna supervisor where AC: Active Antenna Control enabled SD: Short Circuit Detection enabled OD: Open Circuit Detection enabled PDoS: Short Circuit Power Down Logic enabled SR: Automatic Recovery from Short state
PF=3FF	Product configuration.



The line containing the FWVER indicates which version of the firmware is currently running and is called **firmware version** in the rest of the document.



The numbers in parentheses (revision numbers) should only be used to identify a known firmware version and are not guaranteed to increase over time.

2.1.3 Decoding the output of UBX-MON-VER (for Protocol Version 17 and below)

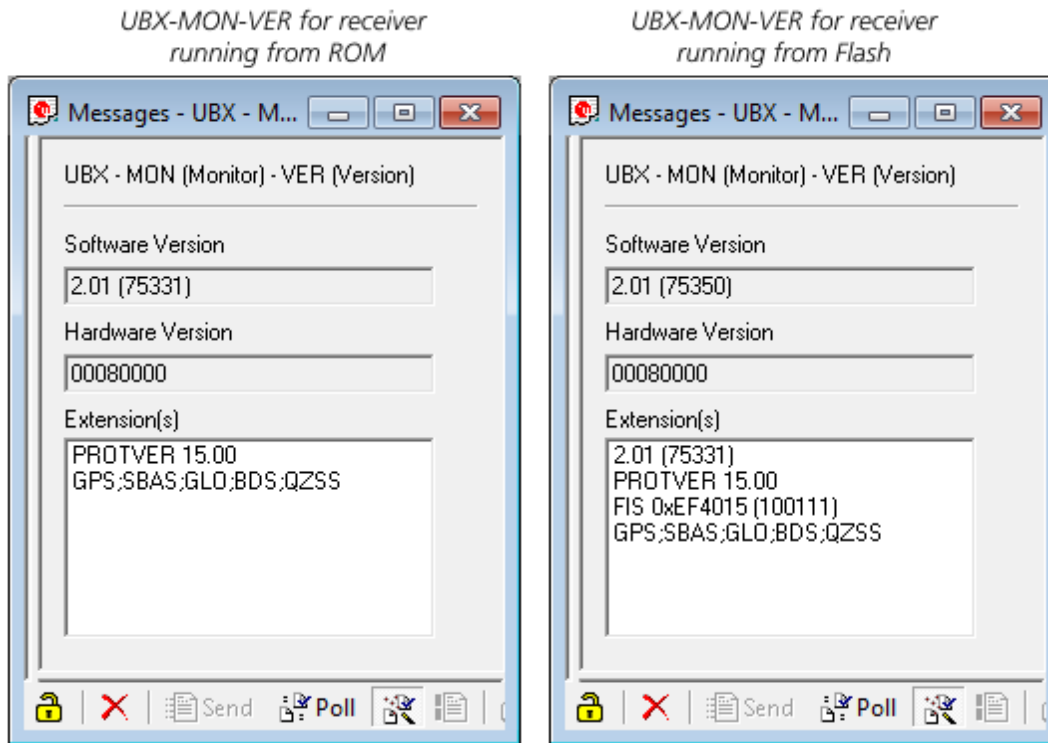

Possible fields in UBX-MON-VER and their meanings:

Entry	Description
Software Version	Currently running firmware version. If no firmware version is shown in the first line of Extension(s), then the u-blox receiver runs from ROM . If a firmware version is shown in the first line of Extension(s), then the u-blox receiver runs from Flash .
Hardware Version	The hardware version of the u-blox receiver.
Extension(s)	Extended information about the u-blox receiver firmware. See table below for the entries.



Not every entry is output by every u-blox receiver in the UBX-MON-VER extensions. This depends on the product, the firmware location and the firmware version.

Possible entries in UBX-MON-VER Extension(s):

Entry	Description
2.01 (75331)	Underlying firmware version in ROM. If such an entry is present, then the u-blox receiver runs from Flash .
PROTVER 15.00	Supported protocol version.
FIS 0xEF4015 (100111)	Flash Information Structure (FIS) file for Flash memory with JEDEC 0xEF4015 found in the external flash memory. Revision number of the file is indicated in brackets.
MOD NEO-M8N-0	Module identification. Set in production.
GPS;SBAS;GLO;BDS;QZSS	Supported GNSS.

2.1.4 Decoding the output of UBX-MON-VER (for Protocol Version 18 and above)

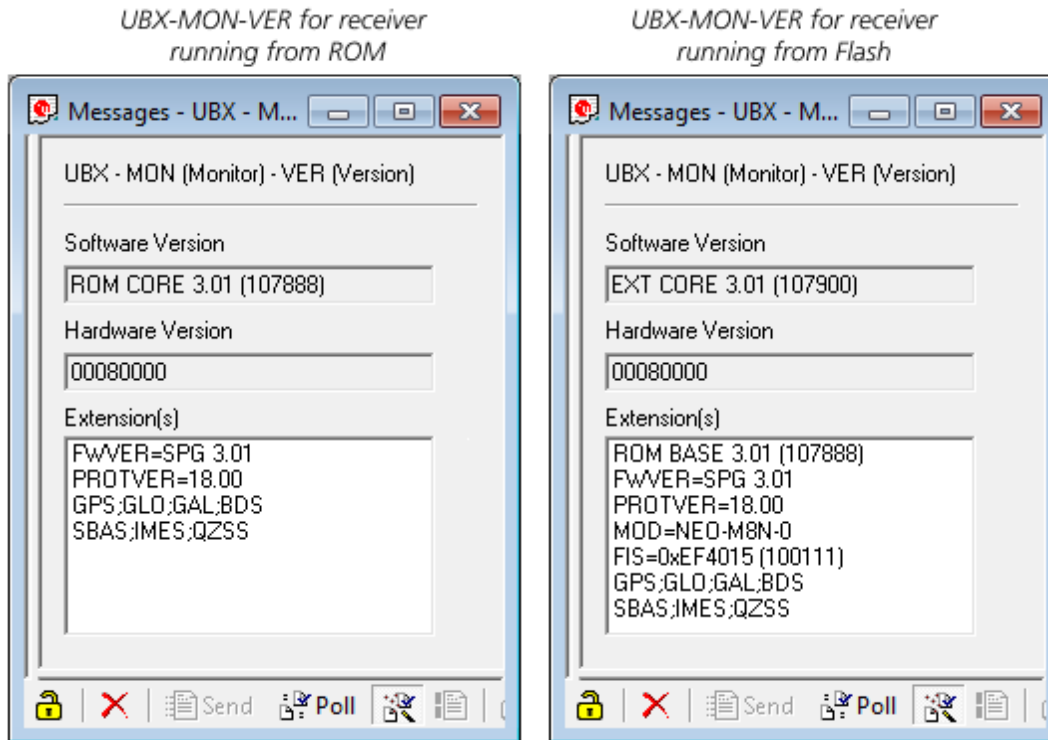

Possible fields in UBX-MON-VER and their meanings:

Entry	Description
Software Version	Currently running firmware version.
ROM CORE 3.01 (107888)	If ROM CORE, then the u-blox receiver runs from ROM .
EXT CORE 3.01 (107900)	If EXT CORE, then the u-blox receiver runs from Flash .
Hardware Version	The hardware version of the u-blox receiver.
Extension(s)	Extended information about the u-blox receiver firmware. See table below for the entries.



Not every entry is output by every u-blox receiver in the UBX-MON-VER extensions. This depends on the product, the firmware location and the firmware version.

Possible entries in UBX-MON-VER Extension(s):

Entry	Description
ROM BASE 3.01 (107888)	Underlying firmware version in ROM. If such an entry is present, then the u-blox receiver runs from Flash .
FWVER=SPG 3.01	Firmware of product category and version where SPG: Firmware of Standard Precision GNSS product HPG: Firmware of High Precision GNSS product ADR: Firmware of ADR product UDR: Firmware of UDR product TIM: Firmware of Time Sync product FIS: Firmware of Time & Frequency Sync product
PROTVER=18.00	Supported protocol version.
MOD=NEO-M8N-0	Module identification. Set in production.

Possible entries in UBX-MON-VER Extension(s): continued

Entry	Description
FIS=0xEF4015 (100111)	Flash Information Structure (FIS) file for Flash memory with JEDEC 0xEF4015 found in the external flash memory. Revision number of the file is indicated in brackets.
GPS ; GLO ; GAL ; BDS	Supported Major GNSS .
SBAS ; IMES ; QZSS	Supported Augmentation systems .

2.2 How to determine the supported protocol version of the u-blox receiver

Each u-blox receiver reports its supported protocol version in the following ways:

- On start-up in the [boot screen](#)
- In the [UBX-MON-VER message](#)

with the line containing `PROTVER` (example: `PROTVER=18.00`).

Additionally, the *firmware string* can be used to look up the corresponding protocol version. The tables below give an overview of the released firmware and their corresponding protocol versions.

2.3 u-blox 8 / u-blox M8 Firmware and Supported Protocol Versions

Firmware for Standard Precision GNSS products

Firmware version	Firmware string	Protocol Version
SPG 2.01	ROM CORE 2.01 (75331) Oct 29 2013 13:28:17	15.00
SPG 2.01	EXT CORE 2.01 (75350) Oct 29 2013 16:15:41	15.00
SPG 3.01	ROM CORE 3.01 (107888)	18.00
SPG 3.01	EXT CORE 3.01 (107900)	18.00
SPG 3.50	EXT CORE 3.50 (190461)	23.00
SPG 3.51	ROM CORE 3.51 (19dc23)	23.01
SPG 3.51	EXT CORE 3.51 (19dc23)	23.01

High Precision GNSS Firmware

Firmware version	Firmware string	Protocol Version
HPG 1.00	EXT CORE 3.01 (111160)	20.00
HPG 1.11	EXT CORE 3.01 (b8bc67)	20.01
HPG 1.20	EXT CORE 3.01 (d34ed4)	20.10
HPG 1.30	EXT CORE 3.01 (d080e3)	20.20
HPG 1.40	TO BE CONFIRMED	20.30

Firmware for Dead Reckoning products

Firmware version	Firmware string	Protocol Version
ADR 3.00	EXT CORE 2.01 (77076) Dec 18 2013 09:40:24 ADR 3.00	15.00
ADR 3.10	EXT CORE 2.01 (87683) Nov 21 2014 14:03:10 ADR 3.10 M8L	15.01
ADR 3.11	EXT CORE 2.01 (89981) Jan 20 2015 17:22:06 ADR 3.11 M8L	15.01
ADR 4.00	EXT CORE 3.01 (16559bf) Apr 21 2016 15:49:07 ADR 4.00	19.00
ADR 4.10	EXT CORE 3.01 (c0c787c) Apr 24 2017 17:31:42 ADR 4.10	19.10
UDR 1.00	EXT CORE 3.01 (16559bf) Apr 21 2016 15:50:59 UDR 1.00	19.00

Firmware for Timing products

<i>Firmware version</i>	<i>Firmware string</i>	<i>Protocol Version</i>
FTS 1.01	EXT CORE 2.20 (81289) May 14 2014 14:11:24	16.00
TIM 1.00	EXT CORE 2.30 (85522) Sep 29 2014 09:40:12	17.00
TIM 1.01	EXT CORE 2.30 (86283) Oct 20 2014 13:51:49	17.00
TIM 1.02	EXT CORE 2.30 (93796) Apr 8 2015 15:53:38	17.00
TIM 1.10	EXT CORE 3.01 (111141)	22.00

Receiver Description

3 Receiver Configuration

3.1 Configuration Concept

u-blox receivers are fully configurable with UBX protocol configuration messages (message class UBX-CFG). The configuration used by the u-blox receiver during normal operation is termed "Current Configuration". The Current Configuration can be changed during normal operation by sending any UBX-CFG-XXX message to the u-blox receiver over an I/O port. The u-blox receiver will change its Current Configuration immediately after receiving the configuration message. The u-blox receiver always uses only the Current Configuration.

Unless the Current Configuration is made permanent by using [UBX-CFG-CFG](#) as described below, the Current Configuration will be lost when there is:

- a power cycle
- a hardware reset
- a (complete) controlled software reset

See the [section on resetting a u-blox receiver](#) for details.

The Current Configuration can be made permanent (stored in a non-volatile memory) by saving it to the "Permanent Configuration". This is done by sending a [UBX-CFG-CFG](#) message with an appropriate **saveMask** (UBX-CFG-CFG/save).

The Permanent Configuration is copied to the Current Configuration during start-up or when a [UBX-CFG-CFG](#) message with an appropriate **loadMask** (UBX-CFG-CFG/load) is sent to the u-blox receiver.

The Permanent Configuration can be restored to the u-blox receiver's Default Configuration by sending a [UBX-CFG-CFG](#) message with an appropriate **clearMask** (UBX-CFG-CFG/clear) to the u-blox receiver. This only replaces the Permanent Configuration, not the Current Configuration. To make the u-blox receiver operate with the Default Configuration which was restored to the Permanent Configuration, a UBX-CFG-CFG/load command must be sent or the u-blox receiver must be reset.

The mentioned masks (saveMask, loadMask, clearMask) are 4-byte bitfields. Every bit represents one configuration sub-section. These sub-sections are defined in section "[Organization of the Configuration Sections](#)". All three masks are part of every UBX-CFG-CFG message. Save, load and clear commands can be combined in the same message. Order of execution is: clear, save, load.

The following diagram illustrates the process:

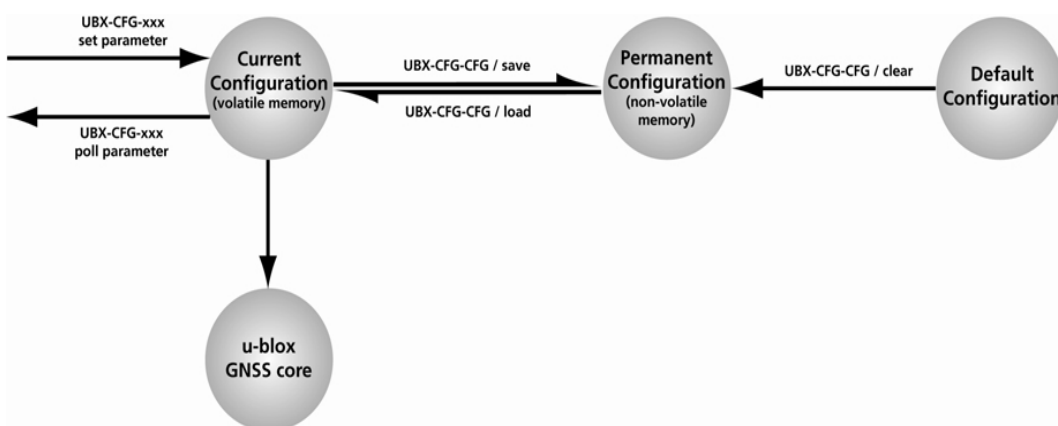

It is possible to change the current communications port settings using a [UBX-CFG-CFG](#) message. This could

affect baud rate and other transmission parameters. Because there may be messages queued for transmission there may be uncertainty about which protocol applies to such messages. In addition a message currently in transmission may be corrupted by a protocol change. Host data reception parameters may have to be changed to be able to receive future messages, including the acknowledge message associated with the UBX-CFG-CFG message.

3.2 Organization of the Configuration Sections

The configuration is divided into several sub-sections. Each of these sub-sections corresponds to one or several UBX-CFG-XXX messages. The sub-section numbers in the following tables correspond to the bit position in the masks mentioned above. All values not listed are reserved

Configuration sub-sections

Number	Name	CFG messages	Description
0	PRT	UBX-CFG-PRT UBX-CFG-USB	Port and USB settings
1	MSG	UBX-CFG-MSG	Message settings (enable/disable, update rate)
2	INF	UBX-CFG-INF	Information output settings (Errors, Warnings, Notice, Test etc.)
3	NAV	UBX-CFG-NAV5 UBX-CFG-NAVX5 UBX-CFG-DAT UBX-CFG-RATE UBX-CFG-SBAS UBX-CFG-NMEA UBX-CFG-TMODE2	Settings for Navigation Parameters, Receiver Datum, Measurement and Navigation Rate, SBAS, NMEA protocol and Time mode (Timing products only)
4	RXM	UBX-CFG-GNSS UBX-CFG-TP5 UBX-CFG-RXM UBX-CFG-PM2 UBX-CFG-ITFM	GNSS Settings, Power Mode Settings, Time Pulse Settings, Jamming/Interference Monitor Settings
9	RINV	UBX-CFG-RINV	Remote Inventory configuration
10	ANT	UBX-CFG-ANT	Antenna configuration
11	LOG	UBX-CFG-LOGFILTER	Logging configuration
12	FTS	UBX-CFG-DOSC UBX-CFG-ESRC UBX-CFG-SMGR	Disciplining configuration. Only applicable to the Time & Frequency Sync product.

3.3 Permanent Configuration Storage Media

The Current Configuration is stored in the volatile RAM of the u-blox receiver. Hence, any changes made to the Current Configuration without saving will be lost if any of the reset events listed in the section above occur. By using UBX-CFG-CFG/save, the selected configuration sub-sections are saved to all non-volatile memories available:

- On-chip BBR (battery backed RAM). In order for the BBR to work, a backup battery must be applied to the u-blox receiver.
- External flash memory, where available.

3.4 u-blox Receiver Default Configuration

The Permanent Configuration can be reset to Default Configuration through a [UBX-CFG-CFG/clear](#) message. The Default Configuration of the u-blox receiver is normally determined when the u-blox receiver is manufactured. Refer to specific product data sheet for further details.

3.5 Save-on-Shutdown Feature

The save-on-shutdown feature (SOS) enables the u-blox receiver to store the contents of the battery-backed RAM to external flash memory and restore it upon startup. This allows the u-blox receiver to preserve some of the features available only with a battery backup (preserving configuration and satellite orbit knowledge) without having a battery backup supply present. It does not, however, preserve any kind of time knowledge. The save-on-shutdown must be commanded by the host. The restore-on-startup is automatically done if the corresponding data is present in the flash. No expiration check of the data is done.

The following outlines the suggested shutdown procedure when using the save-on-shutdown feature:

- The host commands the u-blox receiver to stop using the [UBX-CFG-RST](#) message, specifying reset mode 0x08 ("Controlled GNSS stop") and a BBR mask of 0 ("Hotstart").
- The u-blox receiver confirms the reception of a valid / invalid request with a [UBX-ACK-ACK](#) / [UBX-ACK-NAK](#) message.
- The host commands the saving of the contents of BBR to the flash memory using the [UBX-UPD-SOS-BACKUP](#) message.
- The u-blox receiver confirms the reception of a valid / invalid request with a [UBX-ACK-ACK](#) / [UBX-ACK-NAK](#) message.
- For a valid request the u-blox receiver reports on the success of the backup operation with a [UBX-UPD-SOS-ACK](#) message.
- The host powers off the u-blox receiver.

And consequently the startup procedure is as follows:

- The host powers on the u-blox receiver.
- The u-blox receiver detects the previously stored data in flash. It restores the corresponding memory and reports the success of the operation with a [UBX-UPD-SOS-RESTORED](#) message on the port it had received the save command message (if the output protocol filter on that port allows it). It does not report anything if no stored data has been detected.
- Additionally the u-blox receiver outputs a [UBX-INF-NOTICE](#) and/or a [NMEA-TXT](#) message with the contents `RESTORED` in the boot screen (depends on port and information messages configuration) upon success.
- Optionally the host can deliver coarse time assistance using [UBX-MGA-INI-TIME_UTC](#) for better startup performance.

Once the u-blox receiver has started up it is suggested to delete the stored data using a [UBX-UPD-SOS-CLEAR](#) message. The u-blox receiver responds with a [UBX-ACK-ACK](#) or [UBX-ACK-NAK](#) message.



Note that this feature must not be used with [Power Save Mode](#) and that saved data must be deleted before switching to that mode.

4 Concurrent GNSS

Many u-blox positioning modules and chips are multi-GNSS receivers capable of receiving and processing signals from multiple Global Navigation Satellite Systems (GNSS).

u-blox concurrent GNSS receivers are multi-GNSS receivers that can acquire and track satellites from more than one GNSS system at the same time, and utilize them in positioning.

4.1 GNSS Types

u-blox receivers support a wide range of different GNSS. Some GNSS have large numbers of satellites deployed globally and therefore are generally capable of providing navigation solutions on their own. u-blox designates these as "major GNSS". By contrast, some are designed to be used to enhance the use of one or more major GNSS and u-blox designates these "augmentation systems".

In many cases, such as [satellite numbering](#), this distinction does not matter as u-blox receivers generally try to combine information from all available GNSS to create the best possible navigation information. However, particularly in relation to [configuring the receiver](#), the distinction can be important.

4.1.1 Major GNSS

The major GNSS supported by u-blox receivers are described below.

4.1.1.1 GPS

The Global Positioning System (GPS) is a GNSS operated by the US department of defense. Its purpose is to provide position, velocity and time for civilian and defense users on a global basis. The system currently consists of 32 medium earth orbit satellites and several ground control stations.

4.1.1.2 GLONASS

GLONASS is a GNSS operated by Russian Federation department of defense. Its purpose is to provide position, velocity and time for civilian and defense users on a global basis. The system consists of 24 medium earth orbit satellites and ground control stations.

It has a number of significant differences when compared to GPS. In most cases, u-blox receivers operate in a very similar manner when they are configured to use GLONASS signals instead of GPS. However some aspects of receiver output are likely to be noticeably affected.

4.1.1.3 Galileo



At the time of writing (early 2016), the Galileo system was still under development with only a few fully operational SVs. Therefore, the precise performance and reliability of u-blox receivers when receiving Galileo signals is effectively impossible to guarantee.

Galileo is a GNSS operated by the European Union. Its purpose is to provide position, velocity and time for civilian users on a global basis. The system is currently not fully operational. It is eventually expected to consist of 30 medium earth orbit satellites.

On u-blox M8 receivers a maximum of ten channels can be assigned to Galileo for signal acquisition and tracking. Note that at most eight Galileo satellites will be used for navigation. It is recommended not to set the number of Galileo channels higher than eight in [UBX-CFG-GNSS](#).

4.1.1.3.1 Search and Rescue Return Link Message

The receiver supports reception and output of Search and Rescue (SAR) Return Link Messages (RLM). When enabled, a [UBX-RXM-RLM](#) message will be generated whenever an RLM is detected by the receiver.



At the time of writing (early 2016), no live transmission of RLMs by Galileo SVs had been observed, so the details of their use was impossible to verify completely.

4.1.1.4 BeiDou

BeiDou is a GNSS operated by China. Its purpose is to initially provide position, velocity and time for users in Asia. In a later stage when the system is fully deployed it will have worldwide coverage. The full system will consist of five geostationary, five inclined geosynchronous and 27 medium earth orbit satellites, as well as control, upload and monitoring stations. Although this implies a full constellation of 37 SVs, only SVs numbered 1 to 30 are fully supported in the D1/D2 NAV message described by the Interface Control Document version 2.0. For SVs numbered above 30, there is currently no almanac or differential correction. Consequently, u-blox receivers only use BeiDou SVs numbered 1 to 30.

4.1.2 Augmentation Systems

The augmentation systems supported by u-blox receivers are described below.

4.1.2.1 SBAS

There are a number of Space Based Augmentation Systems (SBAS) operated by different countries using geostationary satellites. u-blox receivers currently support the following:

- WAAS (Wide Area Augmentation System) operated by the US.
- EGNOS (European Geostationary Navigation Overlay Service) operated by the EU.
- MSAS (Multi-functional Satellite Augmentation System) operated by Japan.
- GAGAN (GPS Aided Geo Augmented Navigation) operated by India.

See section [SBAS](#) for more details.

4.1.2.2 QZSS

The Quasi Zenith Satellite System (QZSS) is a regional satellite augmentation system operated by [Japan Aerospace Exploration Agency](#) (JAXA). It is intended as an enhancement to GPS, to increase availability and positional accuracy. The QZSS system achieves this by transmitting GPS-compatible signals in the GPS bands. NMEA messages will show the QZSS satellites only if configured to do so (see section [Satellite Numbering](#)). The QZSS L1SAIF is an additional signal broadcast by QZSS satellites that contains augmentation and other data.

4.1.2.3 IMES

The Indoor MESSaging System (IMES) is an extension to the QZSS specification.

See section [IMES](#) for more details.

4.2 Configuration

The [UBX-CFG-GNSS](#) message allows the user to specify which GNSS signals should be processed along with limits on how many tracking channels should be allocated to each GNSS. The receiver will respond to such a request with a [UBX-ACK-ACK](#) message if it can support the requested configuration or a [UBX-ACK-NAK](#) message if not.



Customers enabling BeiDou and/or Galileo who wish to use the NMEA protocol are recommended to select NMEA version 4.1, as earlier versions have no support for these two GNSS. See the [NMEA protocol section](#) for details on selecting NMEA versions.

The combinations of systems which can be configured simultaneously depends on the receivers capability to

receive several carrier frequencies. The [UBX-MON-GNSS](#) message reports which major GNSS can be selected. Please refer to the data sheet of the corresponding u-blox receiver for full information. Usually GPS, SBAS (e.g. WAAS, EGNOS, MSAS), QZSS and Galileo can be enabled together, because they all use the 1575.42MHz L1 frequency. GLONASS and BeiDou both operate on different frequencies, therefore the receiver must be able to receive a second or even third carrier frequency in order to process these systems together with GPS.



It is recommended to disable GLONASS and BeiDou if a GPS-only antenna or GPS-only SAW filter is used.

In all circumstances, it is necessary for at least one [major GNSS](#) to be enabled. It is also required that at least 4 tracking channels are available to each enabled major GNSS, i.e. `maxTrkCh` must have a minimum value of 4 for each enabled major GNSS. Further requirements on generating configurations acceptable by the receiver can be found in [UBX-CFG-GNSS](#).

4.2.1 Switching between GNSS

Users should be aware that switching between GNSS (and especially away from GPS) may affect the long term accuracy of the receiver until the next [cold start](#). In normal operation the receiver selects the best models and corrections from the transmitted auxiliary data (e.g. UTC and Ionospheric parameters), basing this selection on the configured GNSS. Disabling a major GNSS prevents auxiliary data from that GNSS being refreshed and so it will become stale, resulting in progressively degraded performance. This can occur even if the main power supply is removed, as most receivers retain auxiliary data in non-volatile storage, e.g. Battery Backed RAM (BBR). For this reason, u-blox recommends that receivers are [cold started](#) after any change that disables an active GNSS, within a few weeks, but preferably immediately. This will ensure that the receiver then uses only regularly refreshed information from the newly configured constellations.

4.2.2 Configuring QZSS L1SAIF

By default the receiver will be configured for QZSS L1C/A, this can be changed so the receiver can be configured for QZSS L1SAIF also. See the table below for [UBX-CFG-GNSS](#) `sigCfgMask` settings for signals on QZSS. For example, to enable QZSS L1C/A and QZSS L1SAIF, set the `gnssId` to 5 (for QZSS) and `sigCfgMask` to 0x05. If supported by the firmware, L1SAIF would then be enabled.

QZSS Signal configuration for UBX-CFG-GNSS

<i>GnssId</i>	<i>Description</i>	<i>Signal mask</i>
5	QZSS	0x01 = QZSS L1C/A 0x04 = QZSS L1SAIF

5 SBAS Configuration Settings Description

5.1 SBAS (Satellite Based Augmentation Systems)

SBAS (Satellite Based Augmentation System) is an augmentation technology for GPS, which calculates GPS integrity and correction data with RIMS (Ranging and Integrity Monitoring Stations) on the ground and uses geostationary satellites to broadcast GPS integrity and correction data to GPS users. The correction data is transmitted on the GPS L1 frequency (1575.42 MHz), and therefore no additional receiver is required to make use of the correction and integrity data.



u-blox receivers will only process corrections for GPS. Other corrections are not applied, even if, as planned, some SBAS satellites start to transmit them (e.g. SDCM for GLONASS).

SBAS Principle

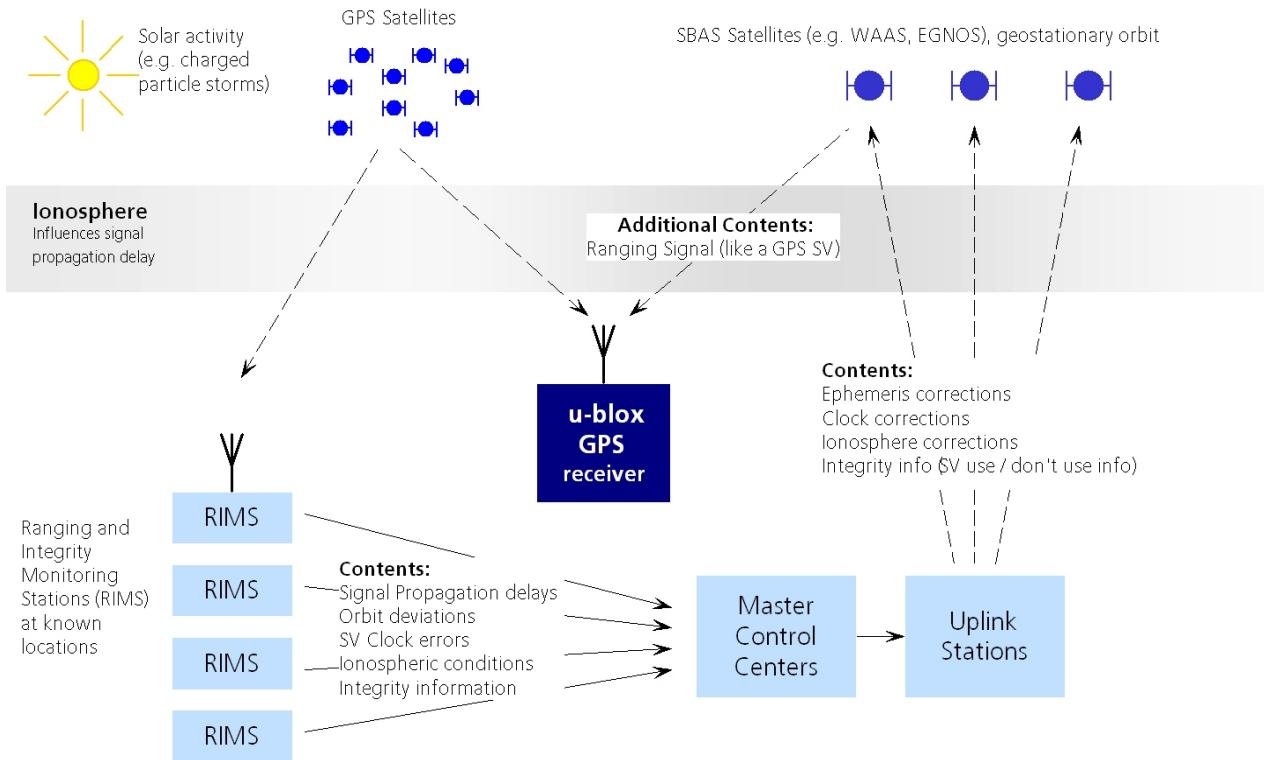

There are several compatible SBAS systems available or in development all around the world:

- WAAS (Wide Area Augmentation System) for North America has been in operation since 2003.
- MSAS (Multi-Functional Satellite Augmentation System) for Japan has been in operation since 2007.
- EGNOS (European Geostationary Navigation Overlay Service) has been in operation since 2009.
- GAGAN (GPS Aided Geo Augmented Navigation), for India has been in operation since 2014.
- SDCM (System for Differential Corrections and Monitoring), for Russia is at the time of writing in test mode.

Support of SBAS allows u-blox GPS technology to take full advantage of the augmentation systems that are currently available (i.e. WAAS, EGNOS, MSAS, GAGAN). Signals from systems currently being tested and/or planned (such as SDCM) may also work, when those systems become fully operational, but this cannot be relied upon and u-blox receivers are not configured to support them by default.

With SBAS enabled, the user benefits from additional satellites for ranging (navigation). u-blox GPS technology uses the available SBAS satellites for navigation just like GPS satellites, if the SBAS satellites offer this service.

To improve position accuracy, SBAS uses different types of correction data:

- **Fast Corrections** for short-term disturbances in GPS signals (due to clock problems, etc).
- **Long-term corrections** for GPS clock problems, broadcast orbit errors etc.
- **Ionosphere corrections** for Ionosphere activity

Another benefit of SBAS is the use of GPS integrity information. In this way SBAS control stations can 'disable' the use of GPS satellites within a 6-second alarm time in case of major GPS satellite problems. If integrity monitoring is enabled, u-blox GPS technology only uses satellites, for which integrity information is available.

For more information on SBAS and associated services, refer to the following resources:

- RTCA/DO-229D (MOPS). Available from www.rtca.org
- gps.faa.gov for information on WAAS.

- www.esa.int for information on EGNOS.
- www.essp-sas.eu for information about European Satellite Services Provider (ESSP), the EGNOS operations manager.
- www.isro.org for information on GAGAN.
- www.sdc.m.ru for information on SDCM.

SBAS satellites tracked (as of November 2015)

Identification	Position	GPS PRN	SBAS Provider
AMR	98° W	133	WAAS
PanAmSat Galaxy XV	133.0° W	135	WAAS
TeleSat Anik F1R	107.3° W	138	WAAS
Inmarsat 3F2 AOR-E	15.5° W	120	EGNOS
Artemis	21.5° W	124	EGNOS
Inmarsat 3F5 IOR-W	25° E	126	EGNOS
MTSAT-1R	140.1° E	129	MSAS
MTSAT-2	145° E	137	MSAS
Inmarsat-4F1/IOR	64° E	127	GAGAN
GSAT-10	83° E	128	GAGAN

5.2 SBAS Features



This u-blox SBAS implementation is, in accordance with standard RTCA/DO-229D, a class Beta-1 equipment. All timeouts etc. are chosen for the En Route Case. Do not use this equipment under any circumstances for "safety of life" applications!

u-blox receivers are capable of receiving multiple SBAS signals concurrently, even from different SBAS systems (WAAS, EGNOS, MSAS, etc.). They can be tracked and used for navigation simultaneously. Every tracked SBAS satellite utilizes one vacant receiver tracking channel. Only the number of receiver channels limits the total number of satellites used. Every SBAS satellite that broadcasts ephemeris or almanac information can be used for navigation, just like a normal GPS satellite.

For receiving correction data, the u-blox receiver automatically chooses the best SBAS satellite as its primary source. It will select only one since the information received from other SBAS satellites is redundant and/or could be inconsistent. The selection strategy is determined by the proximity of the satellites, the services offered by the satellite, the configuration of the receiver (Testmode allowed/disallowed, Integrity enabled/disabled) and the signal link quality to the satellite.

If corrections are available from the chosen SBAS satellite and used in the navigation calculation, the DGPS flag is set in the receiver's output protocol messages (see [NAV-PVT](#), [NAV-SOL](#), [NAV-STATUS](#), [NAV-SVINFO](#), [NMEA Position Fix Flags description](#)). The message [NAV-SBAS](#) provides detailed information about which corrections are available and applied.

The most important SBAS feature for accuracy improvement is Ionosphere correction. The measured data from regional RIMS stations are combined to make a TEC (Total Electron Content) Map. This map is transferred to the receiver via the satellites to allow a correction of the ionosphere error on each received satellite.

Supported SBAS messages

Message Type	Message Content	Source
0(0/2)	Test Mode	All
1	PRN Mask Assignment	Primary
2, 3, 4, 5	Fast Corrections	Primary

Supported SBAS messages continued

Message Type	Message Content	Source
6	Integrity	Primary
7	Fast Correction Degradation	Primary
9	Satellite Navigation (Ephemeris)	All
10	Degradation	Primary
12	Time Offset	Primary
17	Satellite Almanac	All
18	Ionosphere Grid Point Assignment	Primary
24	Mixed Fast / Long term Corrections	Primary
25	Long term Corrections	Primary
26	Ionosphere Delays	Primary

Each satellite services a specific region and its correction signal is only useful within that region. Planning is crucial to determine the best possible configuration, especially in areas where signals from different SBAS systems can be received:

Example 1: SBAS Receiver in North America

In the eastern parts of North America, make sure that EGNOS satellites do not take preference over WAAS satellites. The satellite signals from the EGNOS system should be disallowed by using the PRN Mask.

Example 2: SBAS Receiver in Europe

Some WAAS satellite signals can be received in the western parts of Europe, therefore it is recommended that the satellites from all but the EGNOS system should be disallowed using the PRN Mask.



Although u-blox receivers try to select the best available SBAS correction data, it is recommended to configure them to disallow using unwanted SBAS satellites.



The EGNOS SBAS system does not provide the satellite ranging function.

5.3 SBAS Configuration

To configure the SBAS functionalities use the UBX proprietary message [UBX-CFG-SBAS](#) (SBAS Configuration).

SBAS Configuration parameters

Parameter	Description
Mode - SBAS Subsystem	Enabled / Disabled status of the SBAS subsystem. To enable/disable SBAS operation use UBX-CFG-GNSS . The field in UBX-CFG-SBAS is no longer supported.
Mode - Allow test mode usage	Allow / Disallow SBAS usage from satellites in Test Mode (Message 0)
Services/Usage - Ranging	Use the SBAS satellites for navigation
Services/Usage - Apply SBAS correction data	Combined enable/disable switch for Fast-, Long-Term and Ionosphere Corrections
Services/Usage - Apply integrity information	Use integrity data
Number of tracking channels	Should be set using UBX-CFG-GNSS . The field in UBX-CFG-SBAS is no longer supported.
PRN Mask	Allows selectively enabling/disabling SBAS satellites (e.g. restrict SBAS usage to WAAS-only).

By default, SBAS is enabled with three prioritized SBAS channels and it will use any received SBAS satellites

(except for those in test mode) for navigation, ionosphere parameters and corrections.

6 IMES Description

Indoor Messaging System (IMES) is an extension to the QZSS specification using ground based beacons that broadcast their location. Its purpose is to allow GNSS users to continue to navigate inside buildings, when they can no longer reliably receive satellite based signals.



Operation of IMES beacons is only allowed within Japan.



*u-blox receivers with IMES enabled conform to **IS-QZSS v1.5** and do not support v1.4 or earlier IMES signals. In particular, u-blox receivers rely on the IMES station's carrier frequency being 1575.4282MHz \pm 0.2ppm as specified in the IMES specification. Transmissions from IMES stations that are not within this frequency range are unlikely to be reliably received. Also the receiver expects the preamble 0x9E as well as the correct sequence of CNT values as specified by the IS-QZSS.*

u-blox receivers report the position information they receive from IMES transmitters directly with [UBX-RXM-IMES](#). They do not, however, combine this information with navigation solutions derived from satellite signals (reported via various NMEA and UBX-NAV messages). Consequently, the IMES position information may not always be consistent with satellite signal derived position information.

6.1 IMES Features

- **50/250bps Auto-Detection:** Both 50bps and 250bps IMES signals are supported by u-blox receivers. The transmitter's data rate is detected automatically which allows the receiver to even work in a mixed 50bps/250bps IMES environment.
- **Dynamic Tracking Channel Allocation:** The allocation of the tracking channels is done dynamically, in the same way that channels are allocated to other GNSS. If sufficient IMES stations are within reach of the receiver, it will track as many signals as it can up to the value of `maxTrkCh` configured in [CFG-GNSS](#) (8 by default). To reserve a certain number of channels for IMES only (preventing them from being dynamically allocated to other GNSS), set the `resTrkCh` field in [CFG-GNSS](#) accordingly.
- **Data summary:** A summary of all the tracked IMES signals and what position information they are providing is given in the [UBX-RXM-IMES](#) message.
- **Raw IMES frames:** The raw IMES subframes received from the IMES stations are reported as they are received with [UBX-RXM-SFRBX](#) messages.

7 Navigation Configuration Settings Description

This section relates to the configuration message [UBX-CFG-NAV5](#).

7.1 Platform settings

u-blox receivers support different dynamic platform models (see table below) to adjust the navigation engine to the expected application environment. These platform settings can be changed dynamically without performing a power cycle or reset. The settings improve the receiver's interpretation of the measurements and thus provide a more accurate position output. Setting the receiver to an unsuitable platform model for the given application environment is likely to result in a loss of receiver performance and position accuracy.

Dynamic Platform Models

Platform	Description
Portable	Applications with low acceleration, e.g. portable devices. Suitable for most situations.

Dynamic Platform Models continued

Platform	Description
Stationary	Used in timing applications (antenna must be stationary) or other stationary applications. Velocity restricted to 0 m/s. Zero dynamics assumed.
Pedestrian	Applications with low acceleration and speed, e.g. how a pedestrian would move. Low acceleration assumed.
Automotive	Used for applications with equivalent dynamics to those of a passenger car. Low vertical acceleration assumed.
At sea	Recommended for applications at sea, with zero vertical velocity. Zero vertical velocity assumed. Sea level assumed.
Airborne <1g	Used for applications with a higher dynamic range and greater vertical acceleration than a passenger car. No 2D position fixes supported.
Airborne <2g	Recommended for typical airborne environments. No 2D position fixes supported.
Airborne <4g	Only recommended for extremely dynamic environments. No 2D position fixes supported.
Wrist	Only recommended for wrist worn applications. Receiver will filter out arm motion. (just available for protocol version > 17)

Dynamic Platform Model Details

Platform	Max Altitude [m]	MAX Horizontal Velocity [m/s]	MAX Vertical Velocity [m/s]	Sanity check type	Max Position Deviation
Portable	12000	310	50	Altitude and Velocity	Medium
Stationary	9000	10	6	Altitude and Velocity	Small
Pedestrian	9000	30	20	Altitude and Velocity	Small
Automotive	6000	100	15	Altitude and Velocity	Medium
At sea	500	25	5	Altitude and Velocity	Medium
Airborne <1g	50000	100	100	Altitude	Large
Airborne <2g	50000	250	100	Altitude	Large
Airborne <4g	50000	500	100	Altitude	Large
Wrist	9000	30	20	Altitude and Velocity	Medium



Dynamic platforms designed for high acceleration systems (e.g. airborne <2g) can result in a higher standard deviation in the reported position.



If a sanity check against a limit of the dynamic platform model fails, then the position solution is invalidated. The table above shows the types of sanity checks which are applied for a particular dynamic platform model.

7.2 Navigation Input Filters

The navigation input filters in [CFG-NAV5](#) mask the input data of the navigation engine.



These settings are already optimized. Do not change any parameters unless advised by u-blox support engineers.

Navigation Input Filter parameters

Parameter	Description
fixMode	By default, the receiver calculates a 3D position fix if possible but reverts to 2D position if necessary (Auto 2D/3D). The receiver can be forced to only calculate 2D (2D only) or 3D (3D only) positions.
fixedAlt and fixedAltVar	The fixed altitude is used if fixMode is set to 2D only. A variance greater than zero must also be supplied.

Navigation Input Filter parameters continued

Parameter	Description
minElev	Minimum elevation of a satellite above the horizon in order to be used in the navigation solution. Low elevation satellites may provide degraded accuracy, due to the long signal path through the atmosphere.
cnoThreshNumSVs and cnoThresh	A navigation solution will only be attempted if there are at least the given number of SVs with signals at least as strong as the given threshold.

See also comments in section [Degraded Navigation](#) below.

7.3 Navigation Output Filters

The result of a navigation solution is initially classified by the fix type (as detailed in the `fixType` field of [UBX-NAV-PVT](#) message). This distinguishes between failures to obtain a fix at all ("No Fix") and cases where a fix has been achieved, which are further subdivided into specific types of fixes (e.g. 2D, 3D, dead reckoning).

Where a fix has been achieved, a check is made to determine whether the fix should be classified as valid or not. A fix is only valid if it passes the navigation output filters as defined in [UBX-CFG-NAV5](#). In particular, both PDOP and accuracy values must lie below the respective limits.

Valid fixes are marked using the valid flag in certain NMEA messages (see [Position Fix Flags in NMEA](#)) and the `gnssFixOK` flag in [UBX-NAV-PVT](#) message.



Important: Users are recommended to check the `gnssFixOK` flag in the [UBX-NAV-PVT](#) or the NMEA valid flag. Fixes not marked valid should not normally be used.



The [UBX-NAV-SOL](#) and [UBX-NAV-STATUS](#) messages also report whether a fix is valid in their `gpsFixOK` and `GPSfixOk` flags. These messages have only been retained for backwards compatibility and users are recommended to use the [UBX-NAV-PVT](#) message in preference.

The [UBX-CFG-NAV5](#) message also defines TDOP and time accuracy values that are used in order to establish whether a fix is regarded as locked to GNSS or not, and as a consequence of this, which time pulse setting has to be used. Fixes that do not meet both criteria will be regarded as unlocked to GNSS, and the corresponding time pulse settings of [UBX-CFG-TP5](#) will be used to generate a time pulse.

7.3.1 Speed (3-D) Low-pass Filter

The [UBX-CFG-ODO](#) message offers the possibility to activate a speed (3-D) low-pass filter. The output of the speed low-pass filter is published in the [UBX-NAV-VELNED](#) message (*speed* field). The filtering level can be set via the [UBX-CFG-ODO](#) message (`vellpGain` field) and must be comprised between 0 (heavy low-pass filtering) and 255 (weak low-pass filtering).



Strictly speaking, the internal filter gain is computed as a function of speed. Therefore, the level as defined in the [UBX-CFG-ODO](#) message (`vellpGain` field) defines the nominal filtering level for speeds below 5m/s.

7.3.2 Course over Ground Low-pass Filter

The [UBX-CFG-ODO](#) message offers the possibility to activate a course over ground low-pass filter when the speed is below 8m/s. The output of the course over ground (also named *heading of motion 2-D*) low-pass filter is published in the [UBX-NAV-PVT](#) message (`headMot` field), [UBX-NAV-VELNED](#) message (`heading` field), [NMEA-RMC](#) message (`cog` field) and [NMEA-VTG](#) message (`cogt` field). The filtering level can be set via the [UBX-CFG-ODO](#) message (`cogLpGain` field) and must be comprised between 0 (heavy low-pass filtering) and 255 (weak low-pass filtering).



The filtering level as defined in the [UBX-CFG-ODO](#) message (`cogLpGain` field) defines the filter gain

for speeds below 8m/s. If the speed is higher than 8m/s, no course over ground low-pass filtering is performed.

7.3.3 Low-speed Course Over Ground Filter

The `UBX-CFG-ODO` message offers the possibility to activate a low-speed course over ground filter (also named *heading of motion 2-D*). This filter derives the course over ground from position at very low speed. The output of the low-speed course over ground filter is published in the `UBX-NAV-PVT` message (*headMot* field), `UBX-NAV-VELNED` message (*heading* field), `NMEA-RMC` message (*cog* field) and `NMEA-VTG` message (*cogt* field). If the low-speed course over ground filter is not activated or inactive, then the course over ground is computed as described in section [Freezing the Course Over Ground](#).

7.4 Static Hold

Static Hold Mode allows the navigation algorithms to decrease the noise in the position output when the velocity is below a pre-defined 'Static Hold Threshold'. This reduces the position wander caused by environmental factors such as multi-path and improves position accuracy especially in stationary applications. By default, static hold mode is disabled.

If the speed drops below the defined 'Static Hold Threshold', the Static Hold Mode will be activated. Once Static Hold Mode has been entered, the position output is kept static and the velocity is set to zero until there is evidence of movement again. Such evidence can be velocity, acceleration, changes of the valid flag (e.g. position accuracy estimate exceeding the Position Accuracy Mask, see also section [Navigation Output Filters](#)), position displacement, etc.

The `UBX-CFG-NAV5` message additionally allows for configuration of distance threshold (field `staticHoldMaxDist`). If the estimated position is farther away from the static hold position than this threshold, static mode will be quit.

7.5 Freezing the Course Over Ground

If the low-speed course over ground filter is deactivated or inactive (see section [Low-speed Course over Ground Filter](#)), the receiver derives the course over ground from the GNSS velocity information. If the velocity cannot be calculated with sufficient accuracy (e.g., with bad signals) or if the absolute speed value is very low (under 0.1m/s) then the course over ground value becomes inaccurate too. In this case the course over ground value is frozen, i.e. the previous value is kept and its accuracy is degraded over time. These frozen values will not be output in the NMEA messages `NMEA-RMC` and `NMEA-VTG` unless the NMEA protocol is explicitly configured to do so (see [NMEA Protocol Configuration](#)).

7.6 Degraded Navigation

Degraded navigation describes all navigation modes which use less than four Satellite Vehicles (SV).

7.6.1 2D Navigation

If the receiver only has three SVs for calculating a position, the navigation algorithm uses a constant altitude to compensate for the missing fourth SV. When an SV is lost after a successful 3D fix (min. four SVs available), the altitude is kept constant at the last known value. This is called a 2D fix.



u-blox receivers do not calculate any navigation solution with less than three SVs. Only u-blox Timing products can calculate a timing solution with only one SV when they are in stationary mode.

7.7 Geodetic Coordinate Systems and Ellipsoids

In order to have any useful meaning, the positions reported by a u-blox receiver must be referenced to some coordinate system which defines the origin and, for example, which way is "up". For many reasons, including history, practical autonomy and politics, all the major GNSS define their own theoretical coordinate systems from which they realize a practical reference frame by means of a network of reference points. Specifically:

- GPS uses WGS84
- GLONASS uses PZ90
- Galileo uses GTRF
- BeiDou uses CGCS2000

In practice, the relevant organisations choose to keep their respective frames very close to the International Terrestrial Reference Frame (ITRF), defined and managed by the International Earth Rotation and Reference Systems Service (IERS). However, because the Earth's tectonic plates and even parts of the Earth's core move, new versions of ITRF are defined every few years, generally with changes of the order of a few millimetres. Consequently, the major GNSS occasionally decide that they need to update their reference frames to be better aligned to the latest ITRF. So, for example, GPS switched to WGS84 (G1150) in GPS week 1150 (early 2002) based on ITRF2000, while GLONASS switched from PZ90.02 to PZ90.11 at the end of 2013, based on ITRF2008. The net effect of this, is that all the major GNSS use almost the same reference frame, but there are some small (generally sub-cm) differences between them and these differences occasionally change.

In order to produce positions that can be shown on a map, it is necessary to translate between raw coordinates (e.g. x, y, z) and a position relative to the Earth's surface (e.g. latitude, longitude and altitude) and that requires defining the form of ellipsoid that best matches the shape of the Earth. Historically many different ellipsoid definitions have been used for maps, many of which predate the existence of GNSS and show quite significant differences, leading to discrepancies of as much as 100m in places. Fortunately, most digital maps now use the WGS84 ellipsoid, which is distinct from the WGS84 coordinate system, but defined by the same body.

All u-blox receivers use (the current) version of WGS84 frame as their reference frame, carrying out any necessary corrections internally. What is more, by default, u-blox receivers use the WGS84 ellipsoid and therefore all positions communicated from/to a u-blox receiver will be relative to that. However, users can alter this by specifying their chosen geodetic datum parameters using the **UBX-CFG-DAT** message. The table below indicates the values u-blox recommends for use.

Recommended UBX-CFG-DAT parameters

Ellipsoid	majA	flat	dX	dY	dZ	rotX	rotY	rotZ
WGS84 (default)	6378137.0	298.257223563	0.0	0.0	0.0	0.0	0.0	0.0
PZ90	6378136.0	298.257839303	0.0	0.0	0.0	0.0	0.0	0.0
CGCS2000	6378137.0	298.257227101	0.0	0.0	0.0	0.0	0.0	0.0



Where the receiver is configured to use differential correction data (e.g. via an RTCM stream), as a direct consequence, the receiver's coordinate frame will switch to whatever frame the source of correction data is using.

8 Clocks and Time

8.1 Receiver Local Time

The receiver is dependent on a local oscillator (normally a TCXO or Crystal oscillator) for both the operation of its radio parts and also for timing within its signal processing. No matter what nominal frequency the local oscillator has (e.g. 26 MHz), u-blox receivers subdivide the oscillator signal to provide a 1 kHz reference clock

signal, which is used to drive many of the receiver's processes. In particular, the measurement of satellite signals is arranged to be synchronised with the "ticking" of this 1 kHz clock signal.

When the receiver first starts, it has no information about how these clock ticks relate to other time systems; it can only count time in 1 millisecond steps. However, as the receiver derives information from the satellites it is tracking or from aiding messages, it estimates the time that each 1 kHz clock tick takes in the time-base of the relevant GNSS system. In previous generations of u-blox receivers this was always the GPS time-base, but for this generation it could be GPS, GLONASS, Galileo, or BeiDou. This estimate of GNSS time based on the local 1 kHz clock is called **receiver local time**.

As receiver local time is a mapping of the local 1 kHz reference onto a GNSS time-base, it may experience occasional discontinuities, especially when the receiver first starts up and the information it has about the time-base is changing. Indeed after a cold start receiver local time will initially indicate the length of time that the receiver has been running. However, when the receiver obtains some credible timing information from a satellite or aiding message, it will jump to an estimate of GNSS time.

8.2 Navigation Epochs

Each navigation solution is triggered by the tick of the 1 kHz clock nearest to the desired navigation solution time. This tick is referred to as a **navigation epoch**. If the navigation solution attempt is successful, one of the results is an accurate measurement of time in the time-base of the chosen GNSS system, called **GNSS system time**. The difference between the calculated GNSS system time and receiver local time is called the **clock bias** (and the **clock drift** is the rate at which this bias is changing).

In practice the receiver's local oscillator will not be as stable as the atomic clocks to which GNSS systems are referenced and consequently clock bias will tend to accumulate. However, when selecting the next navigation epoch, the receiver will always try to use the 1 kHz clock tick which it estimates to be closest to the desired fix period as measured in GNSS system time. Consequently the number of 1 kHz clock ticks between fixes will occasionally vary (so when producing one fix per second, there will normally be 1000 clock ticks between fixes, but sometimes, to correct drift away from GNSS system time, there will be 999 or 1001).

The GNSS system time calculated in the navigation solution is always converted to a time in both the GPS and UTC time-bases for output.

Clearly when the receiver has chosen to use the GPS time-base for its GNSS system time, conversion to GPS time requires no work at all, but conversion to UTC requires knowledge of the number of leap seconds since GPS time started (and other minor correction terms). The relevant GPS to UTC conversion parameters are transmitted periodically (every 12.5 minutes) by GPS satellites, but can also be supplied to the receiver via the [UBX-MGA-GPS-UTC](#) aiding message. By contrast when the receiver has chosen to use the GLONASS time-base as its GNSS system time, conversion to GPS time is more difficult as it requires knowledge of the difference between the two time-bases, but conversion to UTC is easier (as GLONASS time is closely linked to UTC).

Where insufficient information is available for the receiver to perform any of these time-base conversions precisely, pre-defined default offsets are used. Consequently plausible times are nearly always generated, but they may be wrong by a few seconds (especially shortly after receiver start). Depending on the configuration of the receiver, such "invalid" times may well be output, but with flags indicating their state (e.g. the "valid" flags in [UBX-NAV-PVT](#)).



u-blox receivers employ multiple GNSS system times and/or receiver local times (in order to support multiple GNSS systems concurrently), so users should not rely on UBX messages that report GNSS system time or receiver local time being supported in future. It is therefore recommended to give preference to those messages that report UTC time.

8.3 iTOW Timestamps

All the main UBX-NAV messages (and some other messages) contain an **iTOW** field which indicates the GPS time at which the navigation epoch occurred. Messages with the same iTOW value can be assumed to have come from the same navigation solution.

Note that iTOW values may not be valid (i.e. they may have been generated with insufficient conversion data) and therefore it is not recommended to use the iTOW field for any other purpose.



The original designers of GPS chose to express time/date as an integer week number (starting with the first full week in January 1980) and a time of week (often abbreviated to TOW) expressed in seconds. Manipulating time/date in this form is far easier for digital systems than the more "conventional" year/month/day, hour/minute/second representation. Consequently, most GNSS receivers use this representation internally, only converting to a more "conventional form" at external interfaces. The iTOW field is the most obvious externally visible consequence of this internal representation.

If reliable absolute time information is required, users are recommended to use the [UBX-NAV-PVT](#) or [UBX-HNR-PVT](#) navigation solution messages which also contain additional fields that indicate the validity (and accuracy in [UBX-NAV-PVT](#)) of the calculated times (see also the [GNSS Times](#) section below for further messages containing time information).

8.4 GNSS Times

Each GNSS has its own time reference for which detailed and reliable information is provided in the messages listed in the table below.

GNSS Times

Time Reference	Message
GPS Time	UBX-NAV-TIMEGPS
BeiDou Time	UBX-NAV-TIMEBDS
GLONASS Time	UBX-NAV-TIMEGLO
Galileo Time	UBX-NAV-TIMEGAL
UTC Time	UBX-NAV-TIMEUTC

8.5 Time Validity

Information about the validity of the time solution is given in the following form:

- **Time validity:** Information about time validity is provided in the `valid` flags (e.g. `validDate` and `validTime` flags in the [UBX-NAV-PVT](#) message). If these flags are set, the time is known and considered as valid for being used. These flags can be found in the GNSS Times table in the [GNSS Times](#) section above as well as in the [UBX-NAV-PVT](#) and [UBX-HNR-PVT](#) messages.
- **Time validity confirmation:** Information about confirmed validity is provided in the `confirmedDate` and `confirmedTime` flags in the [UBX-NAV-PVT](#) message. If these flags are set, the time validity could be confirmed by using an additional independent source, meaning that the probability of the time to be correct is very high. Note that information about time validity confirmation is only available if the `confirmedAvai` bit in the [UBX-NAV-PVT](#) message is set. Check [UBX-NAV-PVT](#) which Protocol Version supports this flag.

8.6 UTC Representation

UTC time is used in many NMEA and UBX messages. In NMEA messages it is always reported rounded to the nearest hundredth of a second. Consequently, it is normally reported with two decimal places (e.g. 124923.52). What is more, although compatibility mode (selected using [UBX-CFG-NMEA](#)) requires three decimal places, rounding to the nearest hundredth of a second remains, so the extra digit is always 0.

UTC time is also reported within some UBX messages, such as [UBX-NAV-TIMEUTC](#) and [UBX-NAV-PVT](#). In these messages date and time are separated into seven distinct integer fields. Six of these (year, month, day, hour, min and sec) have fairly obvious meanings and are all guaranteed to match the corresponding values in NMEA messages generated by the same navigation epoch. This facilitates simple synchronisation between associated UBX and NMEA messages.

The seventh field is called nano and it contains the number of nanoseconds by which the rest of the time and date fields need to be corrected to get the precise time. So, for example, the UTC time 12:49:23.521 would be reported as: hour: 12, min: 49, sec: 23, nano: 521000000.

It is however important to note that the first six fields are the result of rounding to the nearest hundredth of a second. Consequently the nano value can range from -5000000 (i.e. -5 ms) to +994999999 (i.e. nearly 995 ms).

When the nano field is negative, the number of seconds (and maybe minutes, hours, days, months or even years) will have been rounded up. Therefore, some or all of them will need to be adjusted in order to get the correct time and date. Thus in an extreme example, the UTC time 23:59:59.9993 on 31st December 2011 would be reported as: year: 2012, month: 1, day: 1, hour: 0, min: 0, sec: 0, nano: -700000.

Of course, if a resolution of one hundredth of a second is adequate, negative nano values can simply be rounded up to 0 and effectively ignored.

Which master clock the UTC time is referenced to is output in the message [UBX-NAV-TIMEUTC](#).

For [protocol versions 16 or greater](#), the preferred variant of UTC time can be specified using [UBX-CFG-NAV5](#).

8.7 Leap Seconds

Occasionally it is decided (by one of the international time keeping bodies) that, due to the slightly uneven spin rate of the Earth, UTC has moved sufficiently out of alignment with mean solar time (i.e. the Sun no longer appears directly overhead at 0 longitude at midday). A "leap second" is therefore announced to bring UTC back into close alignment. This normally involves adding an extra second to the last minute of the year, but it can also happen on 30th June. When this happens UTC clocks are expected to go from 23:59:59 to 23:59:60 and only then on to 00:00:00.

It is also theoretically possible to have a negative leap second, in which case there will only be 59 seconds in a minute and 23:59:58 will be followed by 00:00:00.

u-blox receivers are designed to handle leap seconds in their UTC output and consequently users processing UTC times from either NMEA and UBX messages should be prepared to handle minutes that are either 59 or 61 seconds long.

Leap second information can be polled from the u-blox receiver with the message [UBX-NAV-TIMELS](#) for [Protocol Version 18 and above](#).

8.8 Real Time Clock

u-blox receivers contain circuitry to support a **real time clock**, which (if correctly fitted and powered) keeps time while the receiver is otherwise powered off. When the receiver powers up, it attempts to use the real time clock to initialise receiver local time and in most cases this leads to appreciably faster first fixes.

8.9 Date

All GNSS frequently transmit information about the current time within their data message. In most cases, this is a time of week (often abbreviated to TOW), which indicates the elapsed number of seconds since the start of the week (midnight Saturday/Sunday). In order to map this to a full date, it is necessary to know which week and so the GNSS also transmit a week number, typically every 30 seconds. Unfortunately the GPS data message was designed in a way that only allows the bottom 10 bits of the week number to be transmitted. This is not sufficient to yield a completely unambiguous date as every 1024 weeks (a bit less than 20 years), the transmitted week number value "rolls over" back to zero. Consequently, GPS receivers can't tell the difference between, for example, 1980, 1999 or 2019 etc.

Fortunately, although BeiDou and Galileo have similar representations of time, they transmit sufficient bits for the week number to be unambiguous for the foreseeable future (the first ambiguity will be in 2078 for Galileo and not until 2163 for BeiDou). GLONASS has a different structure, based on a time of day, but again transmits sufficient information to avoid any ambiguity during the expected lifetime of the system (the first ambiguous date will be in 2124). Therefore, u-blox 8 / u-blox M8 receivers using [Protocol Version 18 and above](#) regard the date information transmitted by GLONASS, BeiDou and Galileo to be unambiguous and, where necessary, use this to resolve any ambiguity in the GPS date.



Customers attaching u-blox receivers to simulators should be aware that GPS time is referenced to 6th January 1980, GLONASS to 1st January 1996, Galileo to 22nd August 1999 and BeiDou to 1st January 2006; the receiver cannot be expected to work reliably with signals that appear to come from before these dates.

8.9.1 GPS-only Date Resolution

In circumstances where only GPS signals are available and for receivers with earlier firmware versions, the receiver establishes the date by assuming that all week numbers must be at least as large as a reference rollover week number. This reference rollover week number is hard-coded into the firmware at compile time and is normally set a few weeks before the s/w is completed, but it can be overridden by the `wknRollover` field of the `UBX-CFG-NAVX5` message to any value the user wishes.

The following example illustrates how this works: Assume that the reference rollover week number set in the firmware at compile time is 1524 (which corresponds to a week in calendar year 2009, but would be transmitted by the satellites as 500). In this case, if the receiver sees transmissions containing week numbers in the range 500 ... 1023, these will be interpreted as week numbers 1524 ... 2047 (CY 2009 ... 2019), whereas transmissions with week numbers from 0 to 499 are interpreted as week numbers 2048 ... 2547 (CY 2019 ... 2028).



It is important to set the reference rollover week number appropriately when supplying u-blox receivers with simulated signals, especially when the scenarios are in the past.

9 Broadcast Navigation Data



Reporting of broadcast navigation data is supported for products using protocol version 17 onwards.

The `UBX-RXM-SFRBX` reports the broadcast navigation data message collected by the receiver from each tracked signal. When enabled, a separate message is generated every time the receiver decodes a complete subframe of data from a tracked signal. The data bits are reported, as received, including preambles and error checking bits as appropriate. However because there is considerable variation in the data structure of the different GNSS signals, the form of the reported data also varies. Indeed, although this document uses the term "subframe" generically, it is not strictly the correct term for all GNSS (e.g. GLONASS has "strings" and Galileo

has "pages").

9.1 Parsing Navigation Data Subframes

Each **UBX-RXM-SFRBX** message contains a subframe of data bits appropriate for the relevant GNSS, delivered in a number of 32 bit words, as indicated by `numWords` field.

Due to the variation in data structure between different GNSS, the most important step in parsing a **UBX-RXM-SFRBX** message is to identify the form of the data. This should be done by reading the `gnssId` field, which indicates which GNSS the data was decoded from. In almost all cases, this is sufficient to indicate the structure and the following sections are organised by GNSS for that reason. However, in some cases the identity of the GNSS is not sufficient, and this is described, where appropriate, in the following sections.

In most cases, the data does not map perfectly into a number of 32 bit words and, consequently, some of the words reported in **UBX-RXM-SFRBX** messages contain fields marked as "Pad". These fields should be ignored and no assumption should be made about their contents.

UBX-RXM-SFRBX messages are only generated when complete subframes are detected by the receiver and all appropriate parity checks have passed.

Where the parity checking algorithm requires data to be inverted before it is decoded (e.g. GPS L1C/A), the receiver carries this out before the message output. Therefore, users can process data directly and do not need to worry about repeating any parity processing.

The meaning of the content of each subframe depends on the sending GNSS and is described in the relevant Interface Control Documents (ICD).

9.2 GPS

For GPS (L1C/A) signals, there is a fairly straightforward mapping between the reported subframe and the structure of subframe and words described in the GPS ICD. Each subframe comprises ten data words, which are reported in the same order they are received.

Each word is arranged as follows:

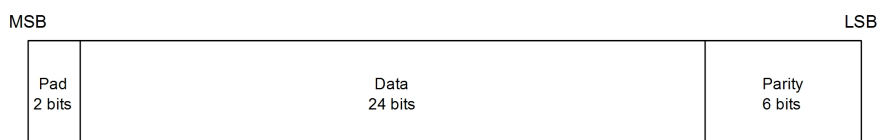

Note that as the GPS data words only comprise 30 bits, the 2 most significant bits in each word reported by **UBX-RXM-SFRBX** are padding and should be ignored.

9.3 GLONASS

For GLONASS (L1OF) signals, each reported subframe contains a string as described in the GLONASS ICD. This string comprises 85 data bits which are reported over three 32 bit words in the **UBX-RXM-SFRBX** message. Data bits 1 to 8 are always a hamming code, whilst bits 81 to 84 are a string number and bit 85 is the idle chip, which should always have a value of zero. The meaning of other bits vary with string and frame number.

The fourth and final 32 bit word in the **UBX-RXM-SFRBX** message contains frame and superframe numbers (where available). These values aren't actually transmitted by the SVs, but are deduced by the receiver and are included to aid decoding of the transmitted data. However, the receiver does not always know these values, in which case a value of zero is reported.

The four words are arranged as follows:

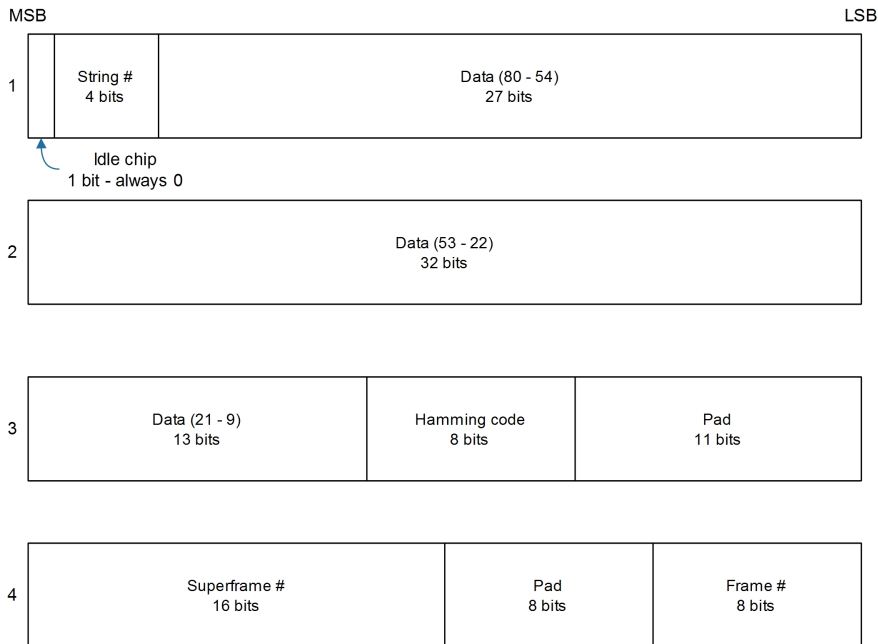

In some circumstances, (especially on startup) the receiver may be able to decode data from a GLONASS SV before it can identify the SV. When this occurs [UBX-RXM-SFRBX](#) messages will be issued with an `svId` of 255 to indicate "unknown".

9.4 BeiDou

For BeiDou (B1I) signals, there is a fairly straightforward mapping between the reported subframe and the structure of subframe and words described in the BeiDou ICD. Each subframe comprises ten data words, which are reported in the same order they are received.

Each word is arranged as follows:

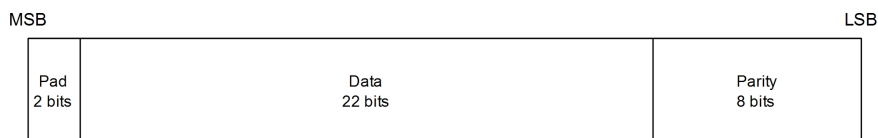

Note that as the BeiDou data words only comprise 30 bits, the 2 most significant bits in each word reported by [UBX-RXM-SFRBX](#) are padding and should be ignored.

9.5 Galileo

For Galileo (E10S) signals, each reported subframe contains a pair of I/NAV pages as described in the Galileo ICD.

Galileo pages can either be "Nominal" or "Alert" pages. For Nominal pages the eight words are arranged as follows:

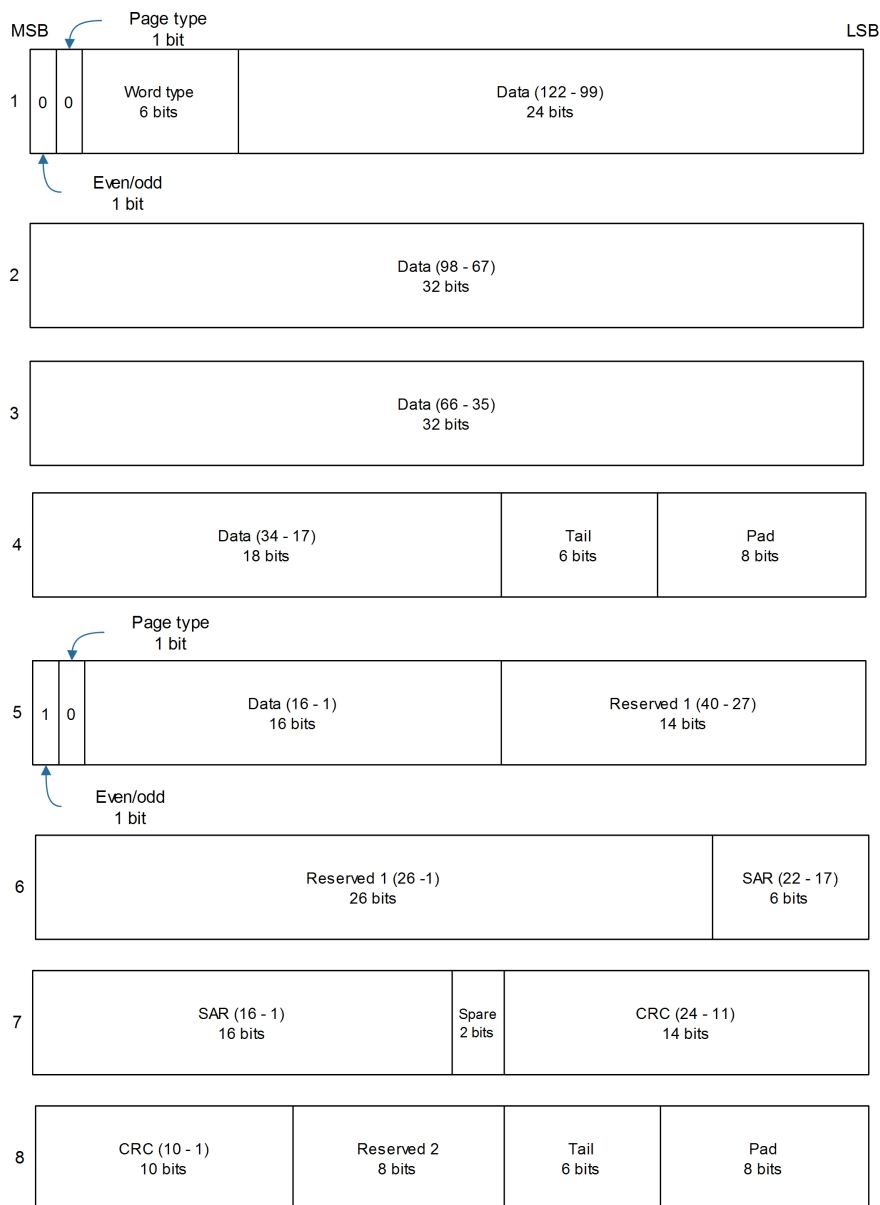

Alert pages are reported in very similar manner, but the page type bits will have value 1 and the structure of the eight words will be slightly different (as indicated by the Galileo ICD).

9.6 SBAS

For SBAS (L1C/A) signals each reported subframe contains eight 32 data words to deliver the 250 bits transmitted in each SBAS data block.

The eight words are arranged as follows:

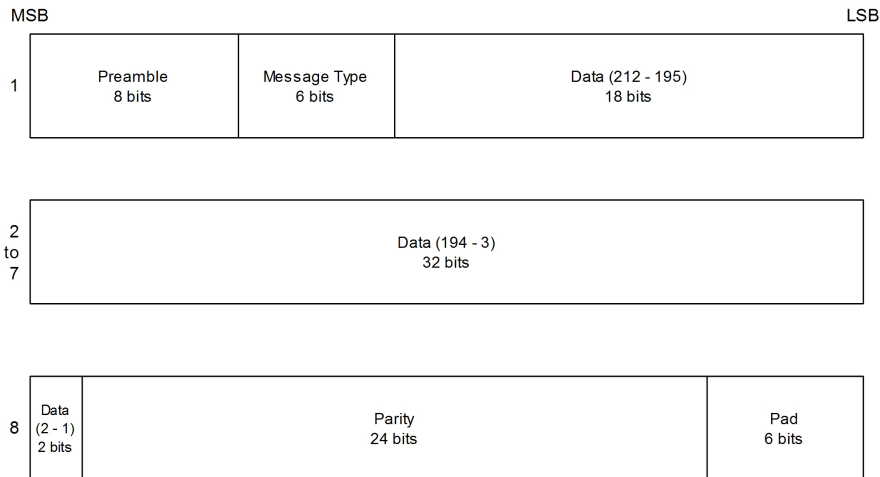

9.7 QZSS

The structure of the data delivered by QZSS (L1C/A) signals is effectively identical to that for [GPS \(L1C/A\)](#).

The QZSS (L1SAIF) signal is different and uses the same data block format as used by [SBAS \(L1C/A\)](#). QZSS (SAIF) signals can be distinguished from QZSS (L1C/A) by noting that they have 8 words, instead of 10 for QZSS (L1C/A).

9.8 IMES

Data messages from IMES are of variable length and u-blox receivers currently support the following varieties:

- Short - comprising of a single word
- Medium - comprising of two words
- Position 1 - comprising of three words
- Position 2 - comprising of four words

As a consequence, an IMES [UBX-RXM-SFRBX](#) message may have a `numWords` value of 1, 2, 3 or 4.

In all cases the structure of words follows the same pattern, with the first word being different from any/all subsequent words as indicated by the following diagram:

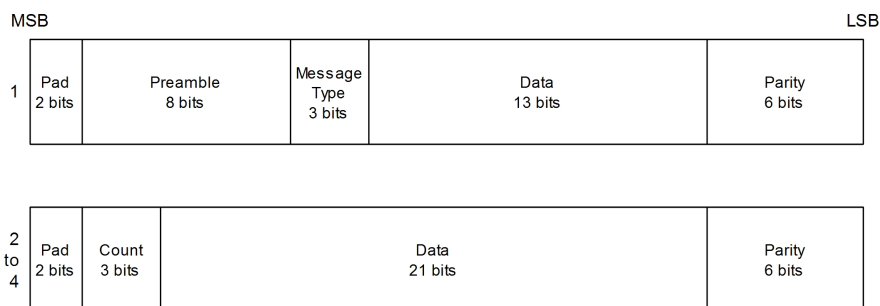

9.9 Summary

The following table gives a summary of the different data message formats reported by the [UBX-RXM-SFRBX](#) message.

Data message formats reported by UBX-RXM-SFRBX

<i>GNSS</i>	<i>Signal</i>	<i>gnssId</i>	<i>numWords</i>	<i>period</i>
GPS	L1C/A	0	10	6s
SBAS	L1C/A	1	8	1s
Galileo	E1OS	2	8	2s
BeiDou	B1I D1	3	10	6s
BeiDou	B1I D2	3	10	0.6s
IMES	Short	4	1	-
IMES	Medium	4	2	-
IMES	Position 1	4	3	-
IMES	Position 2	4	4	-
QZSS	L1C/A	5	10	6s
QZSS	L1SAIF	5	8	1s
GLONASS	L1OF	6	4	2s

10 Serial Communication Ports Description

u-blox receivers come with a highly flexible communication interface. It supports the NMEA and the proprietary UBX protocols, and is truly multi-port and multi-protocol capable. Each protocol (UBX, NMEA) can be assigned to several ports at the same time (multi-port capability) with individual settings (e.g. baud rate, message rates, etc.) for each port. It is even possible to assign more than one protocol (e.g. UBX protocol and NMEA at the same time) to a single port (multi-protocol capability), which is particularly useful for debugging purposes.

To enable a message on a port the UBX and/or NMEA protocol must be enabled on that port using the UBX proprietary message [CFG-PRT](#). This message also allows changing port-specific settings (baud rate, address etc.). See [CFG-MSG](#) for a description of the mechanism for enabling and disabling messages.

The following table shows the port numbers used. Note that any numbers not listed are reserved for future use.

Port Number assignment

<i>Port #</i>	<i>Electrical Interface</i>
0	DDC (I ² C compatible)
1	UART 1
3	USB
4	SPI

10.1 TX-ready indication

This feature enables each port to define a corresponding pin, which indicates if bytes are ready to be transmitted. By default, this feature is disabled. For USB, this feature is configurable but might not behave as described below due to a different internal transmission mechanism. If the number of pending bytes reaches the threshold configured for this port, the corresponding pin will become active (configurable active-low or active-high), and stay active until the last bytes have been transferred from software to hardware (note that this is not necessarily equal to all bytes transmitted, i.e. after the pin has become inactive, up to 16 bytes can still need to be transferred to the host).

The TX-ready pin can be selected from all PIOs which are not in use (see [MON-HW](#) for a list of the PIOs and their mapping), each TX-ready pin is exclusively for one port and cannot be shared. If the PIO is invalid or already in use, only the configuration for the TX-ready pin is ignored, the rest of the port configuration is applied if valid. The acknowledge message does not indicate if the TX-ready configuration is successfully set, it only indicates the successful configuration of the port. To validate successful configuration of the TX-ready pin, the port

configuration should be polled and the settings of TX-ready feature verified (will be set to disabled/all zero if settings invalid).

The threshold should not be set above 2 kB, as the internal message buffer limit can be reached before this, resulting in the TX-ready pin never being set as messages are discarded before the threshold is reached.

10.2 Extended TX timeout

If the host does not communicate over SPI or DDC for more than approximately 2 seconds, the device assumes that the host is no longer using this interface and no more packets are scheduled for this port. This mechanism can be changed enabling "extended TX timeouts", in which case the receiver delays idling the port until the allocated and undelivered bytes for this port reach 4 kB. This feature is especially useful when using the TX-ready feature with a message output rate of less than once per second, and polling data only when data is available, determined by the TX-ready pin becoming active.

10.3 UART Ports

One or two Universal Asynchronous Receiver/Transmitter ([UART](#)) ports are featured, that can be used to transmit GNSS measurements, monitor status information and configure the receiver. See our online product descriptions for availability.

The serial ports consist of an RX and a TX line. Neither handshaking signals nor hardware flow control signals are available. These serial ports operate in asynchronous mode. The baud rates can be configured individually for each serial port. However, there is no support for setting different baud rates for reception and transmission.

Possible UART Interface Configurations

Baud Rate	Data Bits	Parity	Stop Bits
4800	8	none	1
9600	8	none	1
19200	8	none	1
38400	8	none	1
57600	8	none	1
115200	8	none	1
230400	8	none	1
460800	8	none	1

Note that for protocols such as NMEA or UBX, it does not make sense to change the default word length values (data bits) since these properties are defined by the protocol and not by the electrical interface.

If the amount of data configured is too much for a certain port's bandwidth (e.g. all UBX messages output on a UART port with a baud rate of 9600), the buffer will fill up. Once the buffer space is exceeded, new messages to be sent will be dropped. To prevent message losses, the baud rate and communication speed or the number of enabled messages should be selected so that the expected number of bytes can be transmitted in less than one second.

See [CFG-PRT for UART](#) for a description of the contents of the UART port configuration message.

10.4 USB Port

One Universal Serial Bus ([USB](#)) port is featured. See the Data Sheet of your specific product for availability. This port can be used for communication purposes and to power the positioning chip or module.

The USB interface supports two different power modes:

- In *Self Powered Mode* the receiver is powered by its own power supply. **VDDUSB** is used to detect the availability of the USB port, i.e. whether the receiver is connected to a USB host.
- In *Bus Powered Mode* the device is powered by the USB bus, therefore no additional power supply is needed. See the table below for the default maximum current that can be drawn by the receiver. See [CFG-USB](#) for a description on how to change this maximum. Configuring Bus Powered Mode indicates that the device will enter a low power state with disabled GNSS functionality when the host suspends the device, e.g. when the host is put into stand-by mode.

Maximum Current in Bus Powered Mode

Generation	Max Current
u-blox 8 / u-blox M8	100 mA



The voltage range for **VDDUSB** is specified from 3.0V to 3.6V, which differs slightly from the specification for VCC



The boot screen is retransmitted on the USB port after the enumeration. However, messages generated between bootup of the receiver and USB enumeration are not visible on the USB port.

10.5 DDC Port

The Display Data Channel ([DDC](#)) bus is a two-wire communication interface compatible with the I²C standard ([Inter-Integrated Circuit](#)). See our online product selector matrix for availability.

Unlike all other interfaces, the DDC is not able to communicate in full-duplex mode, i.e. TX and RX are mutually exclusive. u-blox receivers act as a slave in the communication setup, therefore they cannot initiate data transfers on their own. The host, which is always master, provides the data clock (SCL), and the clock frequency is therefore not configurable on the slave.

The receiver's DDC address is set to 0x42 by default. This address can be changed by setting the `mode` field in [CFG-PRT for DDC](#) accordingly.

As the receiver will be run in slave mode and the DDC physical layer lacks a handshake mechanism to inform the master about data availability, a layer has been inserted between the physical layer and the UBX and NMEA layer. The receiver DDC interface implements a simple streaming interface that allows the constant polling of data, discarding everything that is not parse-able. The receiver returns 0xFF if no data is available. The [TX-ready](#) feature can be used to inform the master about data availability and can be used as a trigger for data transmission.

10.5.1 Read Access

The DDC interface allows 256 slave registers to be addressed. As shown in Figure *DDC Register Layout* only three of these are currently implemented. The data registers 0 to 252, at addresses 0x00 to 0xFC, each 1 byte in size, contain information to be defined later - the result of reading them is undefined. The currently available number of bytes in the message stream can be read at addresses 0xFD and 0xFE. The register at address 0xFF allows the data stream to be read. If there is no data awaiting transmission from the receiver, then this register will deliver the value 0xff, which cannot be the first byte of a valid message. If message data is ready for transmission then successive reads of register 0xff will deliver the waiting message data.



The registers 0x00 to 0xFC are reserved for future use and may be defined in a later firmware release. Do not use them, as they don't provide any meaningful data!

DDC Register Layout

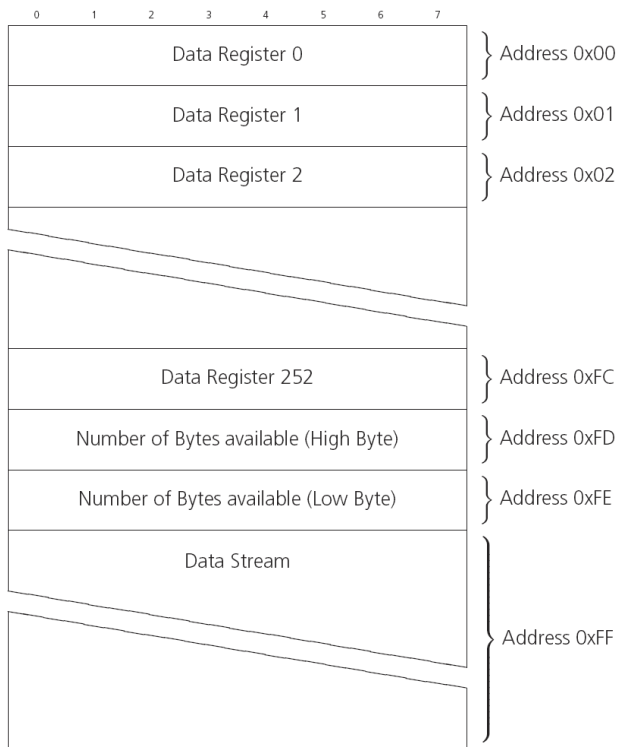

10.5.1.1 Read Access Forms

There are two forms of DDC read transfer. The 'random access' form includes a slave register address and thus allows any register to be read. The second 'current address' form omits the register address. If this second form is used then an address pointer in the receiver is used to determine which register to read. This address pointer will increment after each read unless it is already pointing at register 0xff, the highest addressable register, in which case it remains unaltered. The initial value of this address pointer at startup is 0xff, so by default all current address reads will repeatedly read register 0xff and receive the next byte of message data (or 0xff if no message data is waiting). Figure *DDC Random Read Access* shows the format of the random access form of the request. Following the start condition from the master, the 7-bit device address and the \overline{RW} bit (which is a logic low for write access) are clocked onto the bus by the master transmitter. The receiver answers with an acknowledge (logic low) to indicate that it recognises the address. Next, the 8-bit address of the register to be read must be written to the bus. Following the receiver's acknowledge, the master again triggers a start condition and writes the device address, but this time the \overline{RW} bit is a logic high to initiate the read access. Now, the master can read 1 to N bytes from the receiver, generating a not-acknowledge and a stop condition after the last byte being read.

DDC Random Read Access

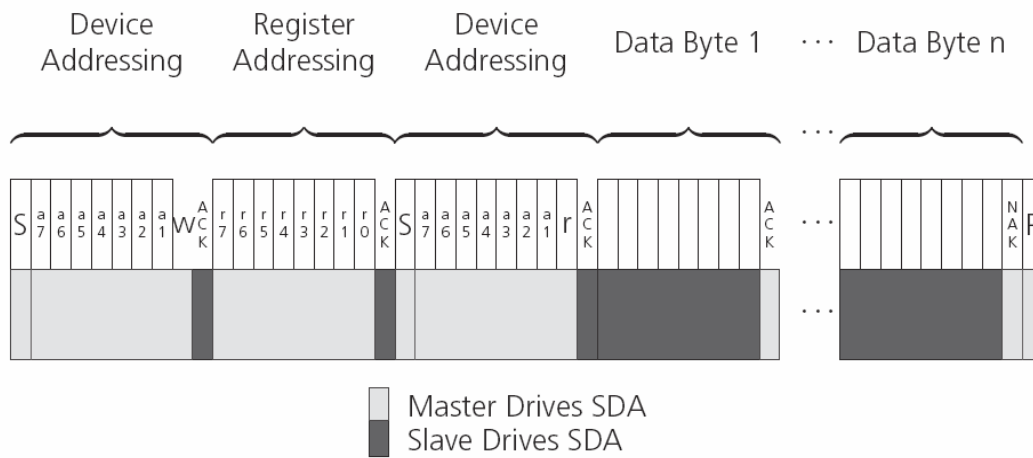

The format of the current address read request is :

DDC Current Address Read Access

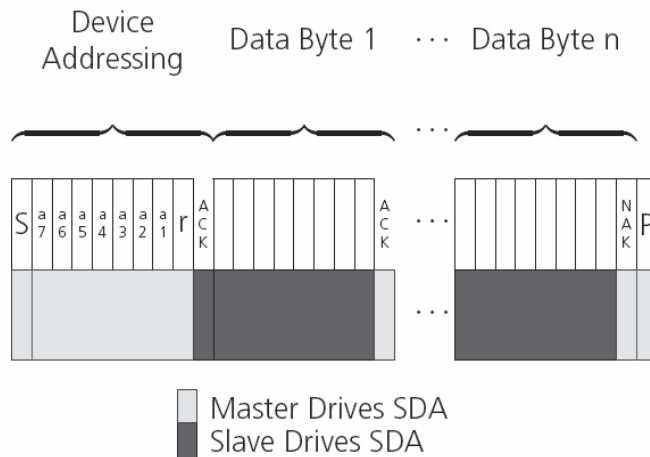

10.5.2 Write Access

The receiver does not provide any write access except for writing UBX and NMEA messages to the receiver, such as configuration or aiding data. Therefore, the register set mentioned in section [Read Access](#) is not writable. Following the start condition from the master, the 7-bit device address and the $\bar{r}w$ bit (which is a logic low for write access) are clocked onto the bus by the master transmitter. The receiver answers with an acknowledge (logic low) to indicate that it is responsible for the given address. Now, the master can write 2 to \mathcal{N} bytes to the receiver, generating a stop condition after the last byte being written. The number of data bytes must be at least 2 to properly distinguish from the write access to set the address counter in random read accesses.

DDC Write Access

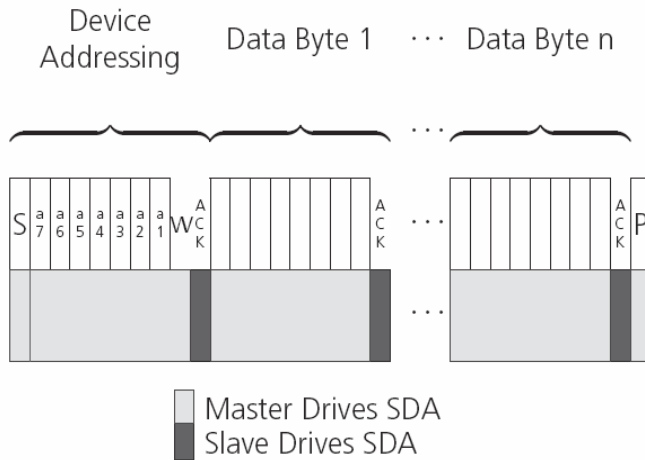

10.6 SPI Port

A Serial Peripheral Interface ([SPI](#)) bus is available with selected receivers. See our online product descriptions for availability.

SPI is a four-wire synchronous communication interface. In contrast to UART, the master provides the clock signal, which therefore doesn't need to be specified for the slave in advance. Moreover, a baud rate setting is not applicable for the slave. SPI modes 0-3 are implemented and can be configured using the field `modeSpi` in `CFG-PRT for SPI` (default is SPI mode 0).



The SPI clock speed is limited depending on hardware and firmware versions!

10.6.1 Maximum SPI clock speed

u-blox 8 / u-blox M8 receivers support a maximum SPI clock speed of 5.5 MHz.

10.6.2 Read Access

As the register mode is not implemented for the SPI port, only the UBX/NMEA message stream is provided. This stream is accessed using the Back-To-Back Read and Write Access (see section [Back-To-Back Read and Write Access](#)). When no data is available to be written to the receiver, `MOSI` should be held logic high, i.e. all bytes written to the receiver are set to 0xFF.

To prevent the receiver from being busy parsing incoming data, the parsing process is stopped after 50 subsequent bytes containing 0xFF. The parsing process is re-enabled with the first byte not equal to 0xFF. The number of bytes to wait for deactivation (50 by default) can be adjusted using the field `ffCnt` in `CFG-PRT for SPI`, which is only necessary when messages shall be sent containing a large number of subsequent 0xFF bytes.

If the receiver has no more data to send, it sets `MISO` to logic high, i.e. all bytes transmitted decode to 0xFF. An efficient parser in the host will ignore all 0xFF bytes which are not part of a message and will resume data processing as soon as the first byte not equal to 0xFF is received.

10.6.3 Back-To-Back Read and Write Access

The receiver does not provide any write access except for writing UBX and NMEA messages to the receiver, such as configuration or aiding data. For every byte written to the receiver, a byte will simultaneously be read from the receiver. While the master writes to `MOSI`, at the same time it needs to read from `MISO`, as any

pending data will be output by the receiver with this access. The data on MISO represents the results from a current address read, returning 0xFF when no more data is available.

SPI Back-To-Back Read/Write Access

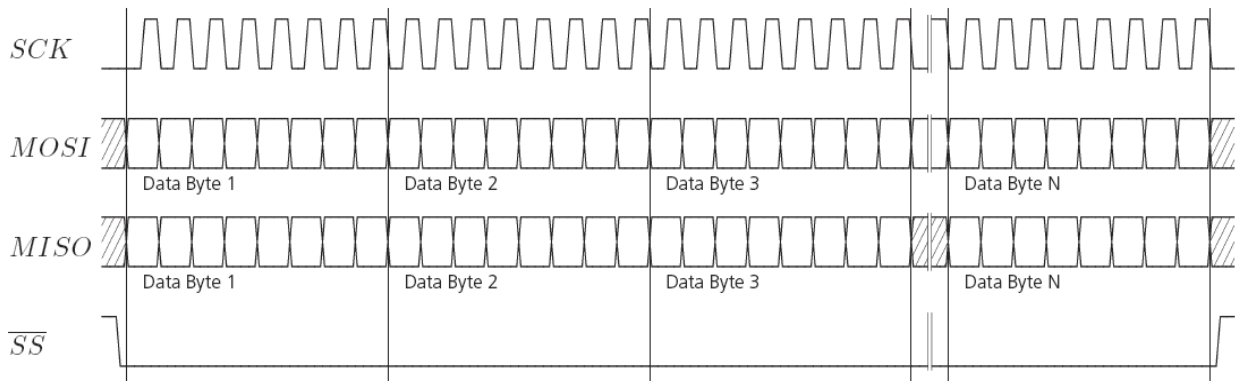

10.7 How to change between protocols

Reconfiguring a port from one protocol to another is a two-step process:

- Step 1: the preferred protocol(s) needs to be enabled on a port using `CFG-PRT`. One port can handle several protocols at the same time (e.g. NMEA and UBX). By default, all ports are configured for UBX and NMEA protocol so in most cases, it's not necessary to change the port settings at all. Port settings can be viewed and changed using the `CFG-PRT` messages.
- Step 2: activate certain messages on each port using `CFG-MSG`.

11 Multiple GNSS Assistance (MGA)

11.1 Introduction

Users would ideally like GNSS receivers to provide accurate position information the moment they are turned on. With standard GNSS receivers there can be a significant delay in providing the first position fix, principally because the receiver needs to obtain data from several satellites and the satellites transmit that data slowly. Under adverse signal conditions, data downloads from the satellites to the receiver can take minutes, hours or even fail altogether.

Assisted GNSS (A-GNSS) is a common solution to this problem and involves some form of reference network of receivers that collect data such as ephemeris, almanac, accurate time and satellite status and pass this onto to the target receiver via any suitable communications link. Such assistance data enables the receiver to compute a position within a few seconds, even under poor signal conditions.

The UBX-MGA message class provides the means for delivering assistance data to u-blox receivers and customers can obtain it from the u-blox AssistNow Online or AssistNow Offline Services. Alternatively they can obtain assistance data from third-party sources (e.g. SUPL/RRLP) and generate the appropriate UBX-MGA messages to send this data to the receiver.

11.2 Assistance Data

u-blox receivers currently accept the following types of assistance data:

- **Position:** Estimated receiver position can be submitted to the receiver using the `UBX-MGA-INI-POS_XYZ` or `UBX-MGA-INI-POS_LLH` messages.

- **Time:** The current time can either be supplied as an inexact value via the standard communication interfaces, suffering from latency depending on the baud rate, or using hardware time synchronization where an accurate time pulse is connected to an external interrupt. The preferred option is to supply UTC time using the [UBX-MGA-INI-TIME_UTC](#) message, but times referenced to some GNSS can be delivered with the [UBX-MGA-INI-TIME_GNSS](#) message.
- **Clock drift:** An estimate of the clock drift can be sent to the receiver using the [UBX-MGA-INI-CLKD](#) message.
- **Frequency:** It is possible to supply hardware frequency aiding by connecting a periodic rectangular signal with a frequency up to 500 kHz and arbitrary duty cycle (low/high phase duration must not be shorter than 50 ns) to an external interrupt, and providing the applied frequency value using the [UBX-MGA-INI-FREQ](#) message.
- **Current orbit data:** Each different GNSS transmits orbit data in slightly different forms. For each system there are separate messages for delivering ephemeris and almanac. So for example GPS ephemeris is delivered to the receiver using the [UBX-MGA-GPS-EPH](#) message, while GLONASS almanac is delivered with the [UBX-MGA-GLO-ALM](#) message.
- **Predicted orbit data:** [UBX-MGA-ANO](#) messages can be used to supply predictions of future orbit information to a u-blox receiver. These messages can be obtained from the AssistNow Offline Service and allow a receiver to improve its TTFF even when it is no longer connected to the Internet.
- **Auxiliary information:** Each GNSS transmits some auxiliary data (such as SV health information or UTC parameters) to the receiver. A selection of messages exist for providing such information to the receiver, such as [UBX-MGA-GPS-IONO](#) for ionospheric data from GPS.
- **EOP:** Earth Orientation Parameters can be sent to the receiver using the [UBX-MGA-INI-EOP](#) message. This will replace the default model used by the AssistNow Autonomous feature and may improve performance (particularly as the receiver gets older and the built-in model decays).
- **Navigation Database:** u-blox receivers can be instructed to dump the current state of their internal navigation database with the [UBX-MGA-DBD-POLL](#) message; sending this information back to the receiver (e.g. after a period when the receiver was turned off) restores the database to its former state, and thus allows the receiver to restart rapidly.

11.3 AssistNow Online

AssistNow Online is u-blox' end-to-end Assisted GNSS (A-GNSS) solution for receivers that have access to the Internet. Data supplied by the AssistNow Online Service can be directly uploaded to a u-blox receiver in order to substantially reduce Time To First Fix (TTFF), even under poor signal conditions. The system works by collecting data such as ephemeris and almanac from the satellites through u-blox' Global Reference Network of receivers and providing this data to customers in a convenient form that can be forwarded on directly to u-blox receivers. The AssistNow Online Service uses a simple, stateless, HTTP interface. Therefore, it works on all standard mobile communication networks that support Internet access, including GPRS, UMTS and Wireless LAN. No special arrangements need to be made with mobile network operators to enable AssistNow Online.

Multiple GNSS Assistance Architecture

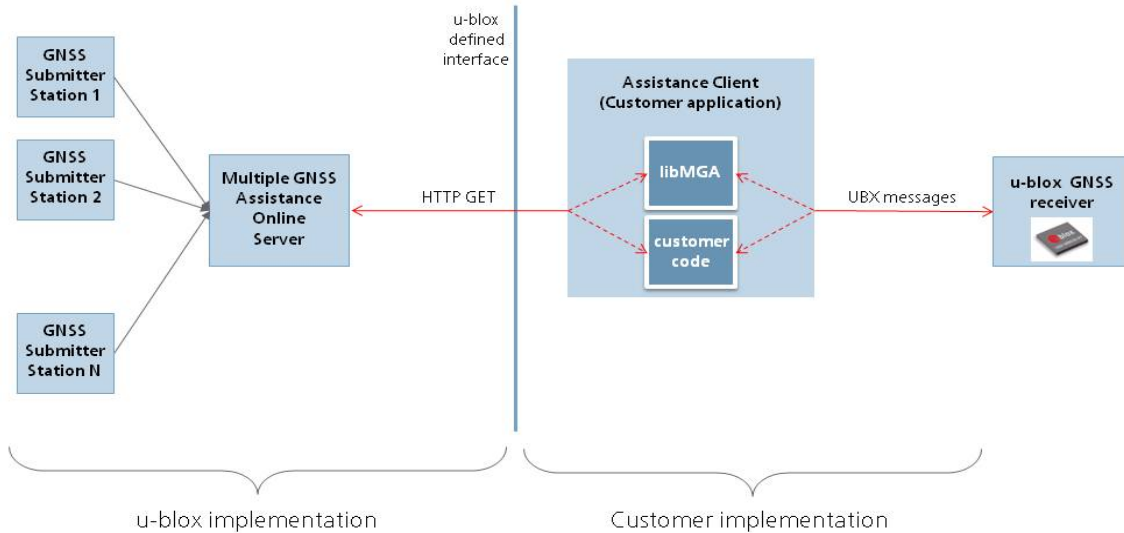

The data returned by the AssistNow Online Service is a sequence of UBX-MGA messages, starting with an estimate of the current time in the form of a [UBX-MGA-INI-TIME_UTC](#) message.



AssistNow Online currently supports GPS, GLONASS, BeiDou, Galileo, and QZSS.



Customers may choose to use third party sources of assistance data instead of using the AssistNow Online Service. Customers choosing this option will need to ensure that the data is converted from the format used by the third party source to the appropriate MGA messages. However, it is important to ensure that the receiver has an estimate of the current time before it processes any other assistance data. For this reason, it is strongly recommended to send a [UBX-MGA-INI-TIME_UTC](#) or [UBX-MGA-INI-TIME_GNSS](#) as the first message of any assistance.

11.3.1 Host Software

As u-blox receivers have no means to connect directly with the Internet, the AssistNow Online system can only work if the host system that contains the receiver can connect to the Internet, download the data from the AssistNow Online Service and forward it on to the receiver. In the simplest case that may involve fetching the data from the AssistNow Online Service (by means of a single HTTP GET request), and sending the resulting data to the receiver.

Depending on the circumstances, it may be beneficial for the host software to include:

- Creating an appropriate [UBX-MGA-INI-TIME_UTC](#) message to deliver a better sense of time to the receiver, especially if the host system has a very good sense of the current time and can deliver a time pulse to one of the receiver's EXTINT pins.
- Enable and use [flow control](#) to prevent loss of data due to buffer overflow in the receiver.



u-blox provides the source code for an example library, called *libMGA*, that provides all of the functionality we expect in most host software.

11.3.2 AssistNow Online Sequence

A typical sequence of use of the AssistNow Online Service comprises the following steps:

- Power-up the u-blox receiver
- Request data from the AssistNow Online Service
- Optionally send `UBX-MGA-INI-TIME_UTC` followed by hardware time synchronization pulse if hardware time synchronization is required.
- Send the UBX messages obtained from the AssistNow Online Service to the receiver.

11.3.3 Flow Control

u-blox receivers aim to process incoming messages as quickly as possible, but there will always be a small delay in processing each message. Uploading assistance data to the receiver can involve sending as many as one hundred of individual messages to the receiver, one after the other. If the communication link is fast, and/or the receiver is busy (trying to acquire new signals), it is possible that the internal buffers will overflow and some messages will be lost. In order to combat this, u-blox receivers support an optional flow control mechanism for assistance.

Flow control is activated by setting the `ackAiding` parameter in the `UBX-CFG-NAVX5` message. As a result the receiver will issue an acknowledgement message (`UBX-MGA-ACK`) for each assistance message it successfully receives. The host software can examine these acknowledgements to establish whether there were any problems with the data sent to the receiver and deduce (by the lack of acknowledgement) if any messages have been lost. It may then be appropriate to resend some of the assistance messages.

The simplest way to implement flow control would be to send one UBX-MGA assistance message at a time, waiting for the acknowledgement, before sending the next. However, such a strategy is likely to introduce significant delays into the whole assistance process. The best strategy will depend on the amount of assistance data being sent and the nature of the communications link (e.g. baud rate of serial link). u-blox recommends that when customers are developing their host software they start by sending all assistance messages and then analyse the resulting acknowledgements to see whether there have been significant losses. Adding small delays during the transmission may be a simple but effective way to avoid substantial loss of data.

11.3.4 Authorization

The AssistNow Online Service is only available for use by u-blox customers. In order to use the services, customers will need to obtain an authorization token from u-blox. This token must be supplied as a parameter whenever a request is made to either service.

11.3.5 Service Parameters

The information exchange with the AssistNow Online Service is based on the HTTP protocol. Upon reception of an HTTP GET request, the server will respond with the required messages in binary format or with an error string in text format. After delivery of all data, the server will terminate the connection.

The HTTP GET request from the client to the server should contain a standard HTTP query string in the request URL. The query string consists of a set of "key=value" parameters in the following form:

```
key=value;key=value;key=value;
```

The following rules apply:

- The order of keys is not important.
- Keys and values are case sensitive.
- Keys and values must be separated by an equals character ('=').

- Key/value pairs must be separated by semicolons (;).
- If a value contains a list, each item in the list must be separated by a comma (,).

The following table describes the keys that are supported.

AssistNow Online Parameter Keys

Key Name	Unit/Range	Optional	Description
token	String	Mandatory	The authorization token supplied by u-blox when a client registers to use the service.
gnss	String	Mandatory	A comma separated list of the GNSS for which data should be returned. Valid GNSS are: gps, qzss and glo.
datatype	String	Mandatory	A comma separated list of the data types required by the client. Valid data types are: eph, alm, aux and pos. Time data is always returned for each request. If the value of this parameter is an empty string, only time data will be returned.
lat	Numeric [degrees]	Optional	Approximate user latitude in WGS 84 expressed in degrees and fractional degrees. Must be in range -90 to 90. Example: lat=47.2.
lon	Numeric [degrees]	Optional	Approximate user longitude in WGS 84 expressed in degrees and fractional degrees. Must be in range -180 to 180. Example: lon=8.55.
alt	Numeric [meters]	Optional	Approximate user altitude above WGS 84 Ellipsoid. If this value is not provided, the server assumes an altitude of 0 meters. Must be in range -1000 to 50000.
pacc	Numeric [meters]	Optional	Approximate accuracy of submitted position (see position parameters note below). If this value is not provided, the server assumes an accuracy of 300km. Must be in range 0 to 6000000.
tacc	Numeric [seconds]	Optional	The timing accuracy (see time parameters note below). If this value is not provided, the server assumes an accuracy of 10 seconds. Must be in range 0 to 3600.
latency	Numeric [seconds]	Optional	Typical latency between the time the server receives the request, and the time when the assistance data arrives at the u-blox receiver. The server can use this value to correct the time being transmitted to the client. If this value is not provided, the server assumes a latency of 0. Must be in range 0 to 3600.
filteronpos	(no value required)	Optional	If present, the ephemeris data returned to the client will only contain data for the satellites which are likely to be visible from the approximate position provided by the lat, lon, alt and pacc parameters. If the lat and lon parameters are not provided the service will return an error.
filteronsv	String	Optional	A comma separated list of u-blox gnssId:svId pairs. The ephemeris data returned to the client will only contain data for the listed satellites.

Thus, as an example, a valid parameter string would be:

```
token=XXXXXXXXXXXXXXXXXXXXXXX;gnss=gps,qzss;datatype=eph,pos,aux;lat=47.28;lon=8.56;pacc=1000
```

11.3.5.1 Position parameters (lat, lon, alt and pacc)

The position parameters (lat, lon, alt and pacc) are used by the server for two purposes:

- If the filteronpos parameter is provided, the server determines the currently visible satellites at the user position, and only sends the ephemeris data of those satellites which should be in view at the location of the

user. This reduces bandwidth requirements. In this case the 'pacc' value is taken into account, meaning that the server will return all SVs visible in the given uncertainty region.

- If the datatype 'pos' is requested, the server will return the position and accuracy in the response data. When this data is supplied to the u-blox receiver, depending on the accuracy of the provided data, the receiver can then choose to select a better startup strategy. For example, if the position is accurate to 100km or better, the u-blox receiver will choose to go for a more optimistic startup strategy. This will result in quicker startup time. The receiver will decide which strategy to choose, depending on the 'pacc' parameter. If the submitted user position is less accurate than what is being specified with the 'pacc' parameter, then the user will experience prolonged or even failed startups.

11.3.5.2 Time parameters (tacc and latency)

Time data is always returned with each request. The time data refers to the time at which the response leaves the server, corrected by an optional latency value. This time data provided by the service is accurate to approximately 10ms but by default the time accuracy is indicated to be +/-10 seconds in order to account for network latency and any time between the client receiving the data and it being provided to the receiver.

If both the network latency and the client latency can safely be assumed to be very low (or are known), the client can choose to set the accuracy of the time message (tacc) to a much smaller value (e.g. 0.5s). This will result in a faster TTFF. The latency can also be adjusted as appropriate. However, these fields should be used with caution: if the time accuracy is not correct when the time data reaches the receiver, the receiver may experience prolonged or even failed start-ups.

For optimal results, the client should establish an accurate sense of time itself (e.g. by calibrating its system clock using a local NTP service) and then modify the time data received from the service as appropriate.

11.3.6 Multiple Servers

u-blox has designed and implemented the AssistNow Online Service in a way that should provide very high reliability. Nonetheless, there will be rare occasions when a server is not available (e.g. due to failure or some form of maintenance activity). In order to protect customers against the impact of such outages, u-blox will run at least two instances of the AssistNow Online Service on independent machines. Customers will have a free choice of requesting assistance data from any of these servers, as all will provide the same information. However, should one fail for whatever reason, it is highly unlikely that the other server(s) will also be unavailable. Therefore customers requiring the best possible availability are recommended to implement a scheme where they direct their requests to a chosen server, but, if that server fails to respond, have a fall-back mechanism to use another server instead.

11.4 AssistNow Offline

AssistNow Offline is a feature that combines special firmware in u-blox receivers and a proprietary service run by u-blox. It is targeted at receivers that only have occasional Internet access and so can't use AssistNow Online. AssistNow Offline speeds up Time To First Fix (TTFF), typically to considerably less than 10s



AssistNow Offline currently supports GPS and GLONASS. u-blox intend to expand the AssistNow Offline Service to support other GNSS (such as BeiDou and Galileo) in due course.

The AssistNow Offline Service uses a simple, stateless, HTTP interface. Therefore, it works on all standard mobile communication networks that support Internet access, including GPRS, UMTS and Wireless LAN. No special arrangements need to be made with mobile network operators to enable AssistNow Offline.

Users of AssistNow Offline are expected to download data from the AssistNow Offline Service, specifying the time period they want covered (1 to 5 weeks) and the types of GNSS. This data must be uploaded to a u-blox receiver, so that it can estimate the positions of the satellites, when no better data is available. Using these

estimates will not provide as accurate a position fix as if current ephemeris data is used, but it will allow much faster TTFFs in nearly all cases.

The data obtained from the AssistNow Offline Service is organised by date, normally a day at a time. Consequently the more weeks for which coverage is requested, the larger the amount of data to handle. Similarly, each different GNSS requires its own data and in the extreme cases, several hundred kilobytes of data will be provided by the service. This amount can be reduced by requesting lower resolution, but this will have a small negative impact on both position accuracy and TTFF. See the section on [Offline Service Parameters](#) for details of how to specify these options.

The downloaded Offline data is encoded in a sequence of `UBX-MGA-ANO` messages, one for every SV for every day of the period covered. Thus, for example, data for all GPS SVs for 4 weeks will involve in excess of 900 separate messages, taking up around 70kbytes. Where a u-blox receiver has flash storage, all the data can be directly uploaded to be stored in the flash until it is needed. In this case, the receiver will automatically select the most appropriate data to use at any time. See the section on [flash-based AssistNow Offline](#) for further details.

AssistNow Offline can also be used where the receiver has no flash storage, or there is insufficient spare flash memory. In this case the customer's system must store the AssistNow Offline data until the receiver needs it and then upload only the appropriate part for immediate use. See the section on [host-based AssistNow Offline](#) for further details.

11.4.1 Service Parameters

The information exchange with the AssistNow Offline Service is based on the HTTP protocol. Upon reception of an HTTP GET request, the server will respond with the required messages in binary format or with an error string in text format. After delivery of all data, the server will terminate the connection.

The HTTP GET request from the client to the server should contain a standard HTTP querystring in the request URL. The querystring consists of a set of "key=value" parameters in the following form:

```
key=value;key=value;key=value;
```

The following rules apply:

- The order of keys is not important.
- Keys and values are case sensitive.
- Keys and values must be separated by an equals character ('=').
- Key/value pairs must be separated by semicolons(';').
- If a value contains a list, each item in the list must be separated by a comma(',').

The following table describes the keys that are supported.

AssistNow Offline Parameter Keys

Key Name	Unit/Range	Optional	Description
token	String	Mandatory	The authorization token supplied by u-blox when a client registers to use the service.
gnss	String	Mandatory	A comma separated list of the GNSS for which data should be returned. The currently supported GNSS are: gps and glo.
period	Numeric [weeks]	Optional	The number of weeks into the future the data should be valid for. Data can be requested for up to 5 weeks in to the future. If this value is not provided, the server assumes a period of 4 weeks.

AssistNow Offline Parameter Keys continued

Key Name	Unit/Range	Optional	Description
resolution	Numeric [days]	Optional	The resolution of the data: 1=every day, 2=every other day, 3=every third day. If this value is not provided, the server assumes a resolution of 1 day.

Thus, as an example, a valid parameter string would be:

token=XXXXXXXXXXXXXXXXXXXXXXXXXX;gnss=gps,glo;

11.4.2 Authorization

The AssistNow Offline Service uses the same authorization process as AssistNow Online; see [above](#) for details.

11.4.3 Multiple Servers

The AssistNow Offline Service uses the same multiple server mechanism to provide high availability as AssistNow Online; see [above](#) for details.

11.4.4 Time, Position and Almanac

While AssistNow Offline can be used on its own, it is expected that the user will provide estimates of the receiver's current position, the current time and ensure that a reasonably up to date almanac is available. In most cases this information is likely to be available without the user needing to do anything. For example, where the receiver is connected to a battery backup power supply and has a functioning real time clock (RTC), the receiver will keep its own sense of time and will retain the last known position and any almanac. However, should the receiver be completely unpowered before startup, then it will greatly improve TTFB if time, position and almanac can be supplied in some form.

Almanac data has a validity period of several weeks, so can be downloaded from the AssistNow Online service at roughly the same time the Offline data is obtained. It can then be stored in the host for uploading on receiver startup, or it can be transferred to the receiver straight away and preserved there (provided suitable non-volatile storage is available).

Obviously, where a receiver has a functioning RTC, it should be able to keep its own sense of time, but where no RTC is fitted (or power is completely turned off), providing a time estimate via the [UBX-MGA-INI-TIME_UTC](#) message will be beneficial.

Similarly, where a receiver has effective non-volatile storage, the last known position will be recalled, but if this is not the case, then it will help TTFB to provide a position estimate via one of the [UBX-MGA-INI-POS_XYZ](#) or [UBX-MGA-INI-POS_LLH](#) messages.

Where circumstance prevent the provision of all three of these pieces of data, providing some is likely to be better than none at all.

11.4.5 Flash-based AssistNow Offline

Flash-based AssistNow Offline functionality means that AssistNow Offline data is stored in the flash memory connected to the chip.

The user's host system must download the data from the AssistNow Offline service when an Internet connection is available, and then deliver all of that data to the u-blox receiver. As the total amount of data to be uploaded is large (typically around 100 kbytes) and writing to flash memory is slow, the upload must be done in blocks of up to 512 bytes, one at a time. The [UBX-MGA-FLASH-DATA](#) message is used to transmit each block to the receiver.



AssistNow Offline data stored in flash memory is not affected by any reset of the receiver. The only

simple ways to clear it are to completely erase the whole flash memory or to overwrite it with a new set of AssistNow Offline data. Uploading a dummy block of data (e.g. all zeros) will also have the effect of deleting the data, although a small amount of flash storage will be used.

11.4.5.1 Flash-based Storage Procedure

The following steps are a typical sequence for transferring AssistNow Offline data into the receiver's flash memory:

- The host downloads a copy of a latest data from the AssistNow Offline service and stores it locally.
- It sends the first 512 bytes of that data using the `UBX-MGA-FLASH-DATA` message.
- It awaits a `UBX-MGA-FLASH-ACK` message in reply.
- Based on the contents of the `UBX-MGA-FLASH-ACK` message it, sends the next block, resends the last block or aborts the whole process.
- The above three steps are repeated until all the rest of the data has been successfully transferred (or the process has been aborted).
- The host sends an `UBX-MGA-FLASH-STOP` message to indicate completion of the upload.
- It awaits the final `UBX-MGA-FLASH-ACK` message in reply. Background processing in the receiver prepares the downloaded data for use at this stage. Particularly if the receiver is currently busy, this may take quite a few seconds, so the host has to be prepared for a delay before the `UBX-MGA-FLASH-ACK` is seen.

Note that the final block may be smaller than 512 bytes (where the total data size is not perfectly divisible by 512). Also, the `UBX-MGA-FLASH-ACK` messages are distinct from the `UBX-MGA-ACK` messages used for other AssistNow functions.

Any existing data will be deleted as soon as the first block of new data arrives, so no useful data will be available till the completion of the data transfer. Each block of data has a sequence number, starting at zero for the first block. In order to guard against invalid partial data downloads the receiver will not accept blocks which are out of sequence.

11.4.6 Host-based AssistNow Offline

Host-based AssistNow Offline involves AssistNow Offline data being stored until it is needed by the user's host system in whatever memory it has available.

The user's host system must download the data from the AssistNow Offline service when an Internet connection is available, but retain it until the time the u-blox receiver needs it. At this point, the host must upload just the relevant portion of the data to the receiver, so that the receiver can start using it. This is achieved by parsing all the data and selecting for upload to the receiver only those `UBX-MGA-ANO` messages with a date-stamp nearest the current time. As each is a complete UBX message it can be sent directly to the receiver with no extra packaging. If required the user can select to employ *flow control*, but in most cases this is likely to prove unnecessary.

When parsing the data obtained from the AssistNow Offline service the following points should be noted:

- The data is made up of a sequence of `UBX-MGA-ANO` messages
- Customers should not rely on the messages all being a fixed sized, but should read their length from the UBX header to work out where the message ends (and where the next begins).
- Each message indicates the SV for which it is applicable through the `svld` and `gnssld` fields.
- Each message contains a date-stamp within the year, month and day fields.
- Midday (UTC) on the day indicated should be considered to be the point at which the data is most applicable.

- The messages will be ordered chronologically, earliest first.
- Messages with same date-stamp will be ordered by ascending gnssid and then ascending svld.

11.4.6.1 Host-based Procedure

The following steps are a typical sequence for host-based AssistNow Offline:

- The host downloads a copy of a latest data from the AssistNow Offline service and stores it locally.
- Optionally it may also download a current set of almanac data from the AssistNow Online service.
- It waits until it want to use the u-blox receiver.
- If necessary it uploads any almanac, position estimate and/or time estimate to the receiver.
- It scans through AssistNow Offline data looking for entries with a date-stamp that most closely matches the current (UTC) time/date.
- It sends each such [UBX-MGA-ANO](#) message to the receiver.

Note that when data has been downloaded from the AssistNow Offline service with the (default) resolution of one day, the means for selecting the closest matching date-stamp is simply to look for ones with the current (UTC) date.

11.5 Preserving Information During Power-off

The performance of u-blox receivers immediately after they are turned on is enhanced by providing them with as much useful information as possible. Assistance (both [Online](#) and [Offline](#)) is one way to achieve this, but retaining information from previous use of the receiver can be just as valuable. All the [types of data delivered by assistance](#) can be retained while the receiver is powered down for use when power is restored. Obviously the value of this data will diminish as time passes, but in many cases it remains very useful and can significantly improve time to first fix.

There are several ways in which a u-blox receiver can retain useful data while it is powered down, including:

- **Battery Backed RAM:** The receiver can be supplied with sufficient power to maintain a small portion of internal storage, while it is otherwise turned off. This is the best mechanism, provided that the small amount of electrical power required can be supplied continuously.
- **Save on Shutdown:** The receiver can be instructed to dump its current state to the attached flash memory (where fitted) as part of the shutdown procedure; this data is then automatically retrieved when the receiver is restarted. See the description of the [UBX-UPD-SOS](#) messages for more information.
- **Database Dump:** The receiver can be asked to dump the state of its internal database in the form of a sequence of UBX messages reported to the host; these messages can be stored by the host and then sent back to the receiver when it has been restarted. See the description of the [UBX-MGA-DBD](#) messages for more information.

11.6 AssistNow Autonomous

(Note: some functionality described in this chapter may not be available in [protocol versions less than 18](#)).

11.6.1 Introduction

The assistance scenarios covered by *AssistNow Online* and *AssistNow Offline* require an online connection and a host that can use this connection to download aiding data and provide this to the receiver when required.

The *AssistNow Autonomous* feature provides a functionality similar to *AssistNow Offline* without the need for a host and a connection. Based on a broadcast ephemeris downloaded from the satellite (or obtained by *AssistNow Online*) the receiver can autonomously (i.e. without any host interaction or online connection)

generate an accurate satellite orbit representation («AssistNow Autonomous data») that is usable for navigation much longer than the underlying broadcast ephemeris was intended for. This makes downloading new ephemeris or aiding data for the first fix unnecessary for subsequent start-ups of the receiver.



The AssistNow Autonomous feature is disabled by default. It can be enabled using the UBX-CFG-NAVX5 message.

11.6.2 Concept

The figure below illustrates the *AssistNow Autonomous* concept in a graphical way. Note that the figure is a qualitative illustration and is not to scale.

- A broadcast ephemeris downloaded from the satellite is a precise representation of a part (for GPS nominally four hours) of the satellite's true orbit (trajectory). It is not usable for positioning beyond this validity period because it diverges dramatically from the true orbit afterwards.
- The *AssistNow Autonomous orbit* is an extension of one or more broadcast ephemerides. It provides a long-term orbit for the satellite for several revolutions. Although this orbit is not perfectly precise it is a sufficiently accurate representation of the true orbit to be used for navigation.
- The *AssistNow Autonomous data* is automatically and autonomously generated from downloaded (or assisted) ephemerides. The data is stored automatically in the on-chip battery-backed memory (BBR). Optionally, the data can be backed-up in external flash memory or on the host. The number of satellites for which data can be stored depends on the receiver configuration and may change during operation.
- If no broadcast ephemeris is available for navigation *AssistNow Autonomous* automatically generates the required parts of the orbits suitable for navigation from the stored data. The data is also automatically kept current in order to minimize the calculation time once the navigation engine needs orbits.
- The operation of the *AssistNow Autonomous* feature is transparent to the user and the operation of the receiver. All calculations are done in background and do not affect the normal operation of the receiver.
- The *AssistNow Autonomous* subsystem automatically invalidates data that has become too old and that would introduce unacceptable positioning errors. This threshold is configurable (see below).
- The prediction quality will be automatically improved if the satellite has been observed multiple times. However, this requires the availability of a suitable flash memory (see the *Hardware Integration Manual* for a list of supported devices). Improved prediction quality also positively affects the maximum usability period of the data.
- *AssistNow Autonomous* considers GPS, GLONASS, Galileo and BeiDou satellites only. It will not consider satellites on orbits with an eccentricity of >0.05 (e.g., Galileo E18). For GLONASS support a suitable flash memory is mandatory because a single broadcast ephemeris spans to little of the orbit (only approx. 30 minutes) in order to extend it in a usable way. Only multiple observations of the same GLONASS satellite that span at least four hours will be used to generate data.

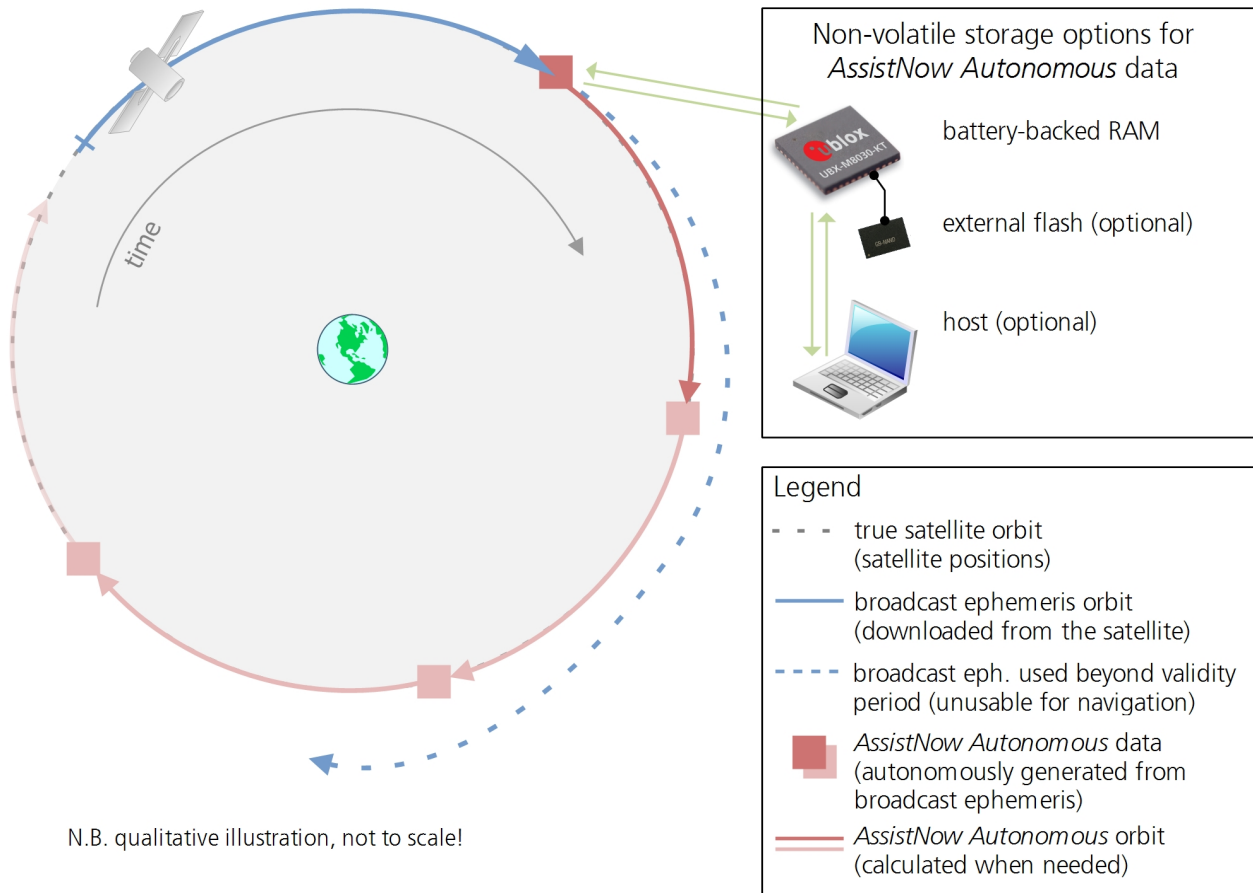

11.6.3 Interface

Several UBX protocol messages provide interfaces to the *AssistNow Autonomous* feature. They are:

- The [UBX-CFG-NAVX5](#) message is used to enable or disable the *AssistNow Autonomous* feature. It is disabled by default. Once enabled, the receiver will automatically produce *AssistNow Autonomous* data for newly received broadcast ephemerides and, if that data is available, automatically provide the navigation subsystem with orbits when necessary and adequate. The message also allows for a configuration of the maximum acceptable orbit error. See the next section for an explanation of this feature. It is recommended to use the firmware default value that corresponds to a default orbit data validity of approximately three days (for GPS satellites observed once) and up to six days (for GPS and GLONASS satellites observed multiple times over a period of at least half a day).
- Note that disabling the *AssistNow Autonomous* feature will delete all previously collected satellite observation data from the flash memory.
- The [UBX-NAV-AOPSTATUS](#) message provides information on the current state of the *AssistNow Autonomous* subsystem. The status indicates whether the *AssistNow Autonomous* subsystem is currently idle (or not enabled) or busy generating data or orbits. Hosts should monitor this information and only power-off the receiver when the subsystem is idle (that is, when the `status` field shows a steady zero).
- The [UBX-NAV-SAT](#) message indicates the use of *AssistNow Autonomous* orbits for individual satellites.
- The [UBX-NAV-ORB](#) message indicates the availability of *AssistNow Autonomous* orbits for individual satellites.
- The [UBX-MGA-DBD](#) message provides a means to retrieve the *AssistNow Autonomous* data from the receiver

in order to preserve the data in power-off mode where no battery backup is available. Note that the receiver requires the absolute time (i.e. full date and time) to calculate *AssistNow Autonomous* orbits. For best performance it is, therefore, recommended to supply this information to the receiver using the `UBX-MGA-INI-TIME.UTC` message in this scenario.

- The [Save-on-Shutdown](#) feature preserves *AssistNow Autonomous* data.

11.6.4 Benefits and Drawbacks

AssistNow Autonomous can provide quicker start-up times (lower the TTFF) provided that data is available for enough visible satellites. This is particularly true under weak signal conditions where it might not be possible to download broadcast ephemerides at all, and, therefore, no fix at all would be possible without *AssistNow Autonomous* (or A-GNSS). It is, however, required that the receiver roughly know the absolute time, either from an RTC or from time-aiding (see the *Interface* section above), and that it knows which satellites are visible, either from the almanac or from tracking the respective signals.

The *AssistNow Autonomous* orbit (satellite position) accuracy depends on various factors, such as the particular type of satellite, the accuracy of the underlying broadcast ephemeris, or the orbital phase of the satellite and Earth, and the age of the data (errors add up over time).

AssistNow Autonomous will typically extend a broadcast ephemeris for up to three to six days. The `UBX-CFG-NAVX5` (see above) message allows changing this threshold by setting the «maximum acceptable modelled orbit error» (in meters). Note that this number does not reflect the true orbit error introduced by extending the ephemeris. It is a statistical value that represents a certain expected upper limit based on a number of parameters. A rough approximation that relates the maximum extension time to this setting is: $maxError [m] = maxAge [d] * f$, where the factor f is 30 for data derived from satellites seen once and 16 for data derived for satellites seen multiple time during a long enough time period (see the *Concept* section above).

There is no direct relation between (true and statistical) orbit accuracy and positioning accuracy. The positioning accuracy depends on various factors, such as the satellite position accuracy, the number of visible satellites, and the geometry (DOP) of the visible satellites. Position fixes that include *AssistNow Autonomous* orbit information may be significantly worse than fixes using only broadcast ephemerides. It might be necessary to adjust the limits of the [Navigation Output Filters](#).

A fundamental deficiency of any system to predict satellite orbits precisely is unknown future events. Hence, the receiver will not be able to know about satellites that will have become unhealthy, have undergone a clock swap, or have had a manoeuvre. This means that the navigation engine might rarely mistake a wrong satellite position as the true satellite position. However, provided that there are enough other good satellites, the navigation algorithms will eventually eliminate a defective orbit from the navigation solution.

The repeatability of the satellite constellation is a potential pitfall for the use of the *AssistNow Autonomous* feature. For a given location on Earth the (GPS) constellation (geometry of visible satellites) repeats every 24 hours. Hence, when the receiver «learned» about a number of satellites at some point in time the same satellites will in most places *not* be visible 12 hours later, and the available *AssistNow Autonomous* data will not be of any help. Again 12 hours later, however, usable data would be available because it had been generated 24 hours ago.

The longer a receiver observes the sky the more satellites it will have seen. At the equator, and with full sky view, approximately ten (GPS) satellites will show up in a one hour window. After four hours of observation approx. 16 satellites (i.e. half the constellation), after 10 hours approx. 24 satellites (2/3rd of the constellation), and after approx. 16 hours the full constellation will have been observed (and *AssistNow Autonomous* data generated for). Lower sky visibility reduces these figures. Further away from the equator the numbers improve because the satellites can be seen twice a day. E.g. at 47 degrees north the full constellation can be observed in

approx. 12 hours with full sky view.

The calculations required for *AssistNow Autonomous* are carried out on the receiver. This requires energy and users may therefore occasionally see increased power consumption during short periods (several seconds, rarely more than 60 seconds) when such calculations are running. Ongoing calculations will automatically prevent the [power save mode](#) from entering the power-off state. The power-down will be delayed until all calculations are done.



The AssistNow Offline and AssistNow Autonomous features are exclusive and should not be used at the same time. Every satellite will be ignored by AssistNow Autonomous if there is AssistNow Offline data available for it.

12 Power Management

u-blox receivers support different power modes. These modes represent strategies of how to control the acquisition and tracking engines in order to achieve either the best possible performance or good performance with reduced power consumption.

Receiver power management can split into two categories:

- **Externally Controlled Power Management:** This includes various modes of power management that are directly operated by the user or host device. These modes are: 1. External cycling of the receiver main power supply. 2. Instruct the receiver to turn On/Off via the [UBX-RXM-PMREQ](#) message. 3. Instruct the receiver to turn On/Off via [external pins](#) (EXTINT0 or EXTINT1)
- **Internally Controlled Power Management:** Here the receiver makes the decision when to power down/up some/all of its internal components according to predefined parameters. It is also referred to as Power Save Modes (PSM). It has two modes of operations: 1. ON/OFF Operation ([PSMOO](#)) 2. Cyclic Tracking ([PSMCT](#)).

The following figure illustrates u-blox power management modes.

u-blox Power Management

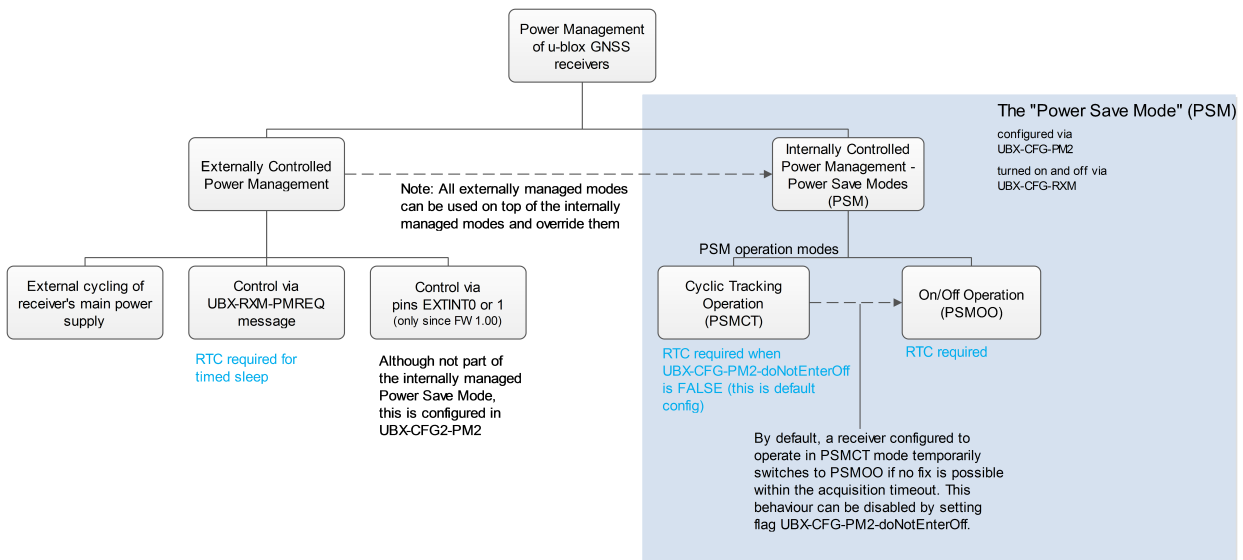

The majority of the Power Management section is detailing the Power Save Mode (Internally Controlled Power Management). However, some the concepts relevant to the Externally Controlled Power Management are detailed, such as the [EXTINT Control](#), [Wake up](#) and [Power On/Off Command](#).

Externally controlled power management operations can be used on top of the Internally Controlled Power Management and they do override their operation.

12.1 Continuous Mode

u-blox receivers make use of dedicated signal processing engines optimized for signal acquisition and tracking. The acquisition engine delivers rapid signal searches during cold starts or when insufficient signals are available for navigation. The tracking engine delivers signal measurements for navigation and acquires new signals as they become available during navigation. The resources of both engines are deployed adaptively to minimize overall power consumption.

12.2 Power Save Mode

Power Save Mode (PSM) allows a reduction in system power consumption by selectively switching parts of the receiver on and off. It is selected using the message [UBX-CFG-RXM](#) and configured using [UBX-CFG-PM2](#).

PSM is designed to only support the operation of GPS, GLONASS, BeiDou, Galileo and QZSS. Enabling SBAS or IMES is possible only if at least one of the other systems is enabled. The PSM state machine behavior will not be altered by enabling SBAS or IMES and it will not take them into account in operation. Therefore, it is recommended to disable them (i.e., SBAS or IMES) when operating in Power Save Mode. They can be disabled using [UBX-CFG-GNSS](#).



The logic within Power Save Mode is designed so that Time Pulse operation is not compromised. This means that entering all power saving states is delayed until the conditions necessary to produce a Time Pulse have been met. Therefore, in order to obtain good Power Save Mode operation, it is essential that any Time Pulse is correctly configured with an appropriate time base, or that Time Pulses are turned off if not needed (by clearing the active flag in [UBX-CFG-TP5](#)).



For protocol versions less than 18: Power Save Mode can only be selected with GPS signals. Other GNSS are not supported.



Note: Power Save Mode is not supported in conjunction with the ADR, UDR and FTS products.

12.2.1 Operation

Power Save Mode has two modes of operation:

- *Power Save Mode Cyclic Tracking (PSMCT) Operation* is used when position fixes are required in short periods of 1 to 10s
- *Power Save Mode ON/OFF (PSMOO) Operation* is used for periods longer than 10s, and can be in the order of minutes, hours or days.

The mode of operation can be configured, and depending on the setting, the receiver demonstrates different behavior: In ON/OFF operation the receiver switches between phases of start-up/navigation and phases with low or almost no system activity (backup/sleep). In cyclic tracking the receiver does not shut down completely between fixes, but uses low power tracking instead.

Currently PSMCT is restricted to update period between 1 and 10 seconds and PSMOO is restricted to update period over 10 seconds. However, this may change in future firmware releases.

PSM is based on a state machine with five different states: *(Inactive) Awaiting Next Fix* and *(Inactive) Awaiting Next Search* states, *Acquisition* state, *Tracking* state and *Power Optimized Tracking (POT)* state.

- *Inactive* states: Most parts of the receiver are switched off.
- *Acquisition* state: The receiver actively searches for and acquires signals. Maximum power consumption.
- *Tracking* state: The receiver continuously tracks and downloads data. Less power consumption than in *Acquisition* state.
- *POT* state: The receiver repeatedly loops through a sequence of tracking (Track), calculating the position fix

(Fix), and entering an idle period (Idle). No new signals are acquired and no data is downloaded. Much less power consumption than in *Tracking* state.

The following figure illustrates the PSM state machine:

State machine

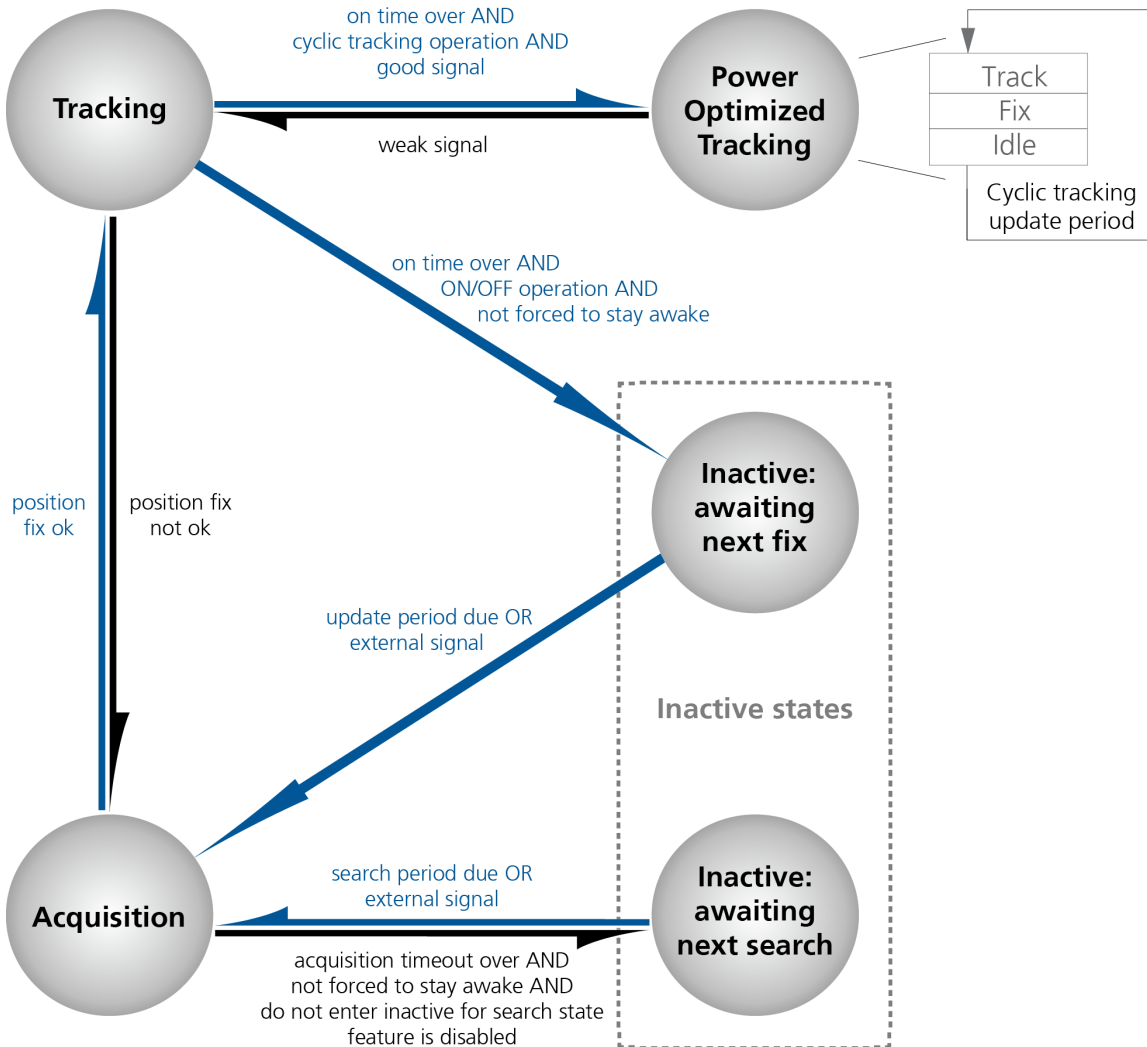

12.2.1.1 Acquisition Timeout Logic

The receiver has internal, external and user configurable mechanisms that determine the time to be spent in acquisition state. This logic is put in place to ensure good performance and low power consumption in different environments and scenarios. This collective logic is referred to as Acquisition Timeout.

Internal mechanisms:

- If the receiver is able to acquire weak signals but not of the quality needed to get a fix, it will transition to *(Inactive) Awaiting Next Search* state after the timeout configured in *maxStartupStateDur* or earlier if too few signals are acquired.
- If the receiver is unable to acquire any signals or it acquires a small number of extremely bad signals (e.g., no sky view), it will transition to *(Inactive) Awaiting Next search* state after 15 seconds or the timeout configured in *maxStartupStateDur* if shorter.

User configurable mechanisms:

- *minAcqTime* is the minimum time that the receiver will spend in *Acquisition* state (see [minAcqTime](#) for details.)
- *maxStartupStateDur* is the maximum time that the receiver will spend in *Acquisition* state (see [maxStartupStateDur](#) for details).
- *doNotEnterOff* forces the receiver to stay awake and in *Acquisition* state even when a fix is not possible (see [doNotEnterOff](#) for details).

External mechanisms:

- The receiver will be forced to stay awake if *extintWake* is enabled and the configured EXTINT pin is set to "high" and it will be forced to stay in *(Inactive) Awaiting Next Search/Fix* states if *extintBackup* is enabled and the configured EXTINT pin is set to "low" (see [EXTINT pin control](#) for details).

12.2.1.2 ON/OFF operation - long update period

When the receiver is switched on, it first enters *Acquisition* state. If it is able to obtain a valid position fix within the time given by the [Acquisition Timeout](#), it switches to *Tracking* state. Otherwise it enters *(Inactive) Awaiting Next Search* state and re-starts after the configured search period (minus a start-up margin). As soon as the receiver gets a valid position fix (one passing the [navigation output filters](#)), it enters *Tracking* state. Upon entering *Tracking* state, the *onTime* starts. Once the *onTime* is over, *(Inactive) Awaiting Next Fix* state is entered and the receiver re-starts according to the configured update grid (see section [Grid offset](#) for an explanation). If the signal is lost while in *Tracking* state, *Acquisition* state is entered. If the signal is not found within the acquisition timeout, the receiver enters *(Inactive) Awaiting Next Search* state. Otherwise the receiver will re-enter *Tracking* state and stay there until the newly started *onTime* is over.

The diagram below illustrates how ON/OFF operation works:

Diagram of ON/OFF operation

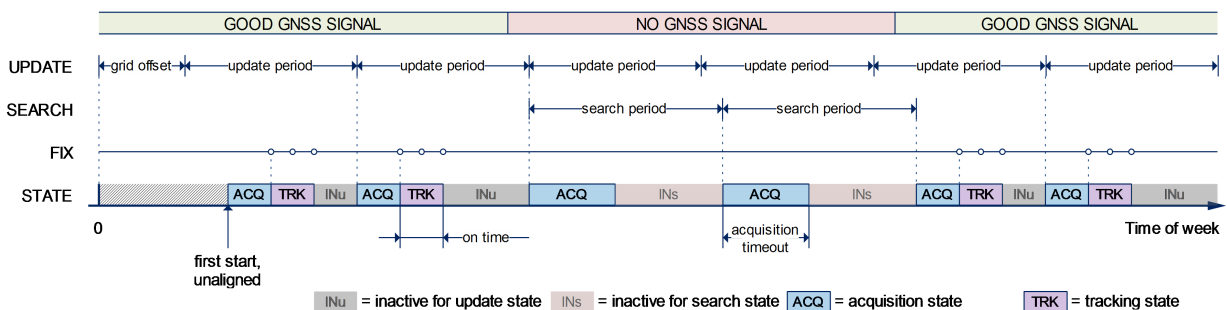

12.2.1.3 Cyclic tracking operation - short update period

When the receiver is switched on, it first enters *Acquisition* state. If it is able to obtain a position fix within the time given by the acquisition timeout, it switches to *Tracking* state. Otherwise, it will enter *(Inactive) Awaiting Next Search* state and re-start within the configured search grid. After a valid position fix, *Tracking* state is entered and the *onTime* starts. In other words the *onTime* starts with the first valid position fix. Once the *onTime* is over, *POT* state is entered. In *POT* state the receiver continues to output position fixes according to the *updatePeriod*. To have maximum power savings, set the *onTime* to zero. This causes the receiver to enter *POT* state as soon as possible. If the signal becomes weak or is lost during *POT* state, *Tracking* state is entered. Once the signal is good again and the newly started *onTime* is over, the receiver will re-enter *POT* state. If the receiver can't get a position fix in the *Tracking* state, it enters *Acquisition* state. Should the acquisition fail as well, *(Inactive) Awaiting Next Search* state is entered. If *doNotEnterOff* is enabled and no fix is possible, the receiver will remain in *Acquisition* state until a fix is possible and it will never enter *(Inactive) Awaiting Next Search* state.

The diagram below illustrates how cyclic tracking operation works:

Diagram of cyclic tracking operation

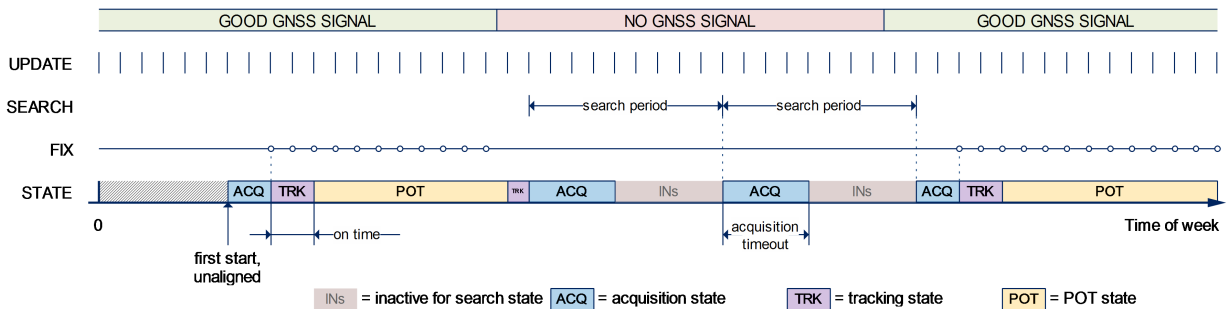

12.2.1.4 User controlled operation - update and search period of zero

Setting the updatePeriod to zero causes the receiver to wait in the (*Inactive*) *Awaiting Next Fix* state until woken up by the user. Setting the search period to zero causes the receiver to wait in the (*Inactive*) *Awaiting Next Search* state indefinitely after an unsuccessful start-up. Any wake-up event will re-start the receiver. See section [Wake up](#) for more information on wake-up events.



External wake-up is required when setting update or search period to zero.

12.2.1.5 Satellite data download

The receiver is not able to download satellite data (e.g. the ephemeris) while it is working in ON/OFF or cyclic tracking operation. Therefore it has to temporarily switch to continuous operation for the time the satellites transmit the desired data. To save power the receiver schedules the downloads according to an internal timetable and only switches to continuous operation while data of interest is being transmitted by the satellites.

Each SV transmits its own ephemeris data. Ephemeris data download is feasible when the corresponding satellite has been tracked with a sufficient C/No over a certain period of time. The download is scheduled in a 30 minute grid or immediately when fewer than a certain number of visible satellites have valid ephemeris data. Almanac, ionosphere, UTC correction and SV health data are transmitted by all SVs simultaneously. Therefore these parameters can be downloaded when a single SV is tracked with a high enough C/No.

Allowing more ephemerides to be downloaded before going into *POT* or (*Inactive*) *Awaiting Next Fix* state can help improve the quality of the fixes and reduce the number of wake ups needed to download ephemerides at the cost of extra time in *Acquisition* state (only when an inadequate number of ephemerides are downloaded from tracked satellites).

12.2.2 Configuration

Power Save Mode is enabled and disabled with the `UBX-CFG-RXM` message and configured with the `UBX-CFG-PM2` message.



When enabling Power Save Mode, the receiver will be unable to download or process any SBAS or IMES data. Therefore, there is no benefit in enabling them and it is recommended to disable both systems. SBAS support and IMES support can be disabled using `UBX-CFG-GNSS`.

A number of parameters can be used to customize PSM to your specific needs. These parameters are listed in the following table:

Power Save Mode configuration options on UBX-CFG-PM2

Parameter	Description
mode	Receiver mode of operation

Power Save Mode configuration options on UBX-CFG-PM2 continued

Parameter	Description
updatePeriod	Time between two position fix attempts
searchPeriod	Time between two acquisition attempts if the receiver is unable to get a position fix
minAcqTime	Minimum time the receiver spends in <i>Acquisition</i> state
onTime	Time the receiver remains in <i>Tracking</i> state and produces position fixes
waitTimeFix	Wait for time fix before entering <i>Tracking</i> state
doNotEnterOff	Receiver does not enter (<i>Inactive</i>) <i>Awaiting Next Search</i> state if it can't get a position fix but keeps indefinitely attempting a position fix instead
updateRTC	Enables periodic Real Time Clock (RTC) update
updateEPH	Enables periodic ephemeris update
extintSelect	Selects EXTINT pin used with pin control feature
extintWake	Enables force-ON pin control feature
extintBackup	Enables force-OFF pin control feature
gridOffset	Time offset of update grid with respect to start of week
maxStartupStateDur	Maximum time in <i>Acquisition</i> state

12.2.2.1 Mode of operation (mode)

The mode of operation to use mainly depends on the update period: For short update periods (in the range of a few seconds), cyclic tracking should be configured. For long update periods (in the range of minutes or longer), only use ON/OFF operation.

See section [ON/OFF operation - long update period](#) and [Cyclic tracking operation - short update period](#) for more information on the two modes of operation.

12.2.2.2 Reference Time Standard

In older versions (in [protocol versions less than 18](#)), only GPS can be configured for PSM, therefore, GPS time standard is used for the operation of PSM. Whereas, in newer versions where multiple GNSS can operate simultaneously (in [protocol versions 18+](#)), UTC time standard is used.

12.2.2.3 Update period (updatePeriod) and search period (searchPeriod)

The update period specifies the time between successive position fixes. If no position fix can be obtained within the acquisition timeout, the receiver will retry after the time specified by the search period. Update and search periods are fixed with respect to an absolute time grid based on reference time standard (i.e., GPS Time or UTC. see [Reference Time Standard](#)). They do not refer to the time of the last valid position fix or last position fix attempt.



New settings are ignored if the update period or the search period exceeds the maximum number of milliseconds in a week. In that case the previously stored values remain effective.

12.2.2.4 Minimum Acquisition Time (minAcqTime)

The receiver tries to obtain a position fix for at least the time given in minAcqTime. If the receiver determines that it needs more time for the given starting conditions then it will automatically prolong this time. If minAcqTime is set to zero then the minimum acquisition time is exclusively determined by the receiver. Once the minAcqTime has expired, the receiver will terminate the acquisition state if either a fix is achieved or if the receiver estimates that any signals received are insufficient (too weak or too few) for a fix to be possible.

12.2.2.5 On time (onTime)

The *onTime* parameter specifies how long the receiver stays in *Tracking* state before switching to the *POT* state (in PSMCT) or *(Inactive) Awaiting Next Fix* state (in PSMOO).

12.2.2.6 Wait for time fix (waitTimeFix)

A time fix is a fix type in which the receiver will ensure that the time is accurate and confirmed to within the limits set in [UBX-CFG-NAV5](#). Enabling the *waitTimeFix* option will force the receiver to stay in *Acquisition* state until the time is known to within the configured limits then it will transition to *Tracking* state. Enabling *waitTimeFix* will delay the transition from *Acquisition* state to *Tracking* state by at least two extra seconds, thus, this should be taken into account (see [Acquisition Timeout](#)). It is necessary to enable *waitTimeFix* in timing products.

The quality of the position fixes can also be configured by setting the limits in the message [UBX-CFG-NAV5](#). Setting harder limits in [UBX-CFG-NAV5](#) will typically prolong the time in *Acquisition* state. Thus, ensuring sufficient time is given to the receiver at start-up (when externally controlled) is necessary (see [Acquisition Timeout Logic](#)). When internally controlled, the receiver can make good judgement on the time needed in *Acquisition* state and no further adjustments will be needed.

12.2.2.7 Maximum Startup State Duration (maxStartupStateDur)

(only supported in [protocol versions 17+](#)).

The *maxStartupStateDur* is the maximum time that the receiver will spend in *Startup* state (i.e., *Acquisition* state). If the receiver is unable to acquire a valid position fix within this maximum time, it will transition to *(Inactive) Awaiting Next Search* state (if *doNotEnterOff* is disabled). Subsequently, the receiver will attempt to acquire another position fix according to the search period (see [Update period \(updatePeriod\)](#) and [search period \(searchPeriod\)](#)). If *maxStartupStateDur* is set to zero, the receiver will autonomously determine the maximum time to spend in *Acquisition* state. Note that shorter settings (below about 45s) will degrade an unaided receiver's ability to collect new Ephemeris data at low signal levels (see section [Satellite data download](#)).

12.2.2.8 Do not enter '(Inactive) Awaiting Next Search' state when no fix (doNotEnterOff)

If this option is enabled, the receiver acts differently in case it can't get a fix: instead of entering *(Inactive) Awaiting Next Search* state, it keeps attempting to acquire a position fix. In other words, the receiver will never be in *(Inactive) Awaiting Next Search* state and therefore *searchPeriod* and *minAcqTime* will be ignored.

12.2.2.9 Update RTC (updateRTC) and Ephemeris (updateEPH)

To maintain the ability of a fast start-up, the receiver needs to calibrate its RTC and update its ephemeris data on a regular basis. This can be ensured by activating the update RTC and update Ephemeris option. The RTC is calibrated every 5 minutes and the ephemeris data is updated approximately every 30 minutes. See section [Satellite data download](#) for more information.

12.2.2.10 EXTINT pin control

The operation of PSM can be externally controlled using either EXTINT0 or EXTINT1 pin. This external control allows the user to decide when to wake up the receiver to obtain a fix and when to force the receiver into sleep/backup mode to save power. Operating the receiver externally through the EXTINT pins will override internal functions that coincide with that specific operation.

The choice of which pin to use can be configured through the *extintSelect* feature in [UBX-CFG-PM2](#). Only one pin can be selected at a time but it is sufficient to perform all the required tasks.

If the Force-ON (*extintWake*) feature in [UBX-CFG-PM2](#) is enabled, the receiver will not enter Inactive states for

as long as the configured EXTINT pin (EXTINT0 or EXTINT1) is at 'high' level. The receiver will therefore always be in *Acquisition/Tracking* state in PSMOO or in *Acquisition/Tracking/POT* state in PSMCT. When the pin level changes to 'low' the receiver will continue with its configured behavior.

If the Force-OFF (*extintBackup*) feature in [UBX-CFG-PM2](#) is enabled, the receiver will enter Inactive states for as long as the configured EXTINT pin is set to 'low' until the next wake up event. Any wake-up event can wake up the receiver even while the EXTINT pin is set to 'low' (see [Wake up](#)). However, if the pin stay at 'low' state, the receiver will only wake up for the time needed to read the configuration pin settings then it will enter the Inactive state again.

If both Force-ON and Force-OFF features are enabled at the same time, the receiver PSM operation will be completely in user control. Setting 'high' on the configured EXTINT pin will wake up the receiver to get a position fix and setting 'low' will put the receiver into sleep/backup mode.

12.2.2.11 Grid offset (gridOffset)

Once the receiver has a valid time, the update grid is aligned to the start of the week of the [reference time standard](#) (midnight between Saturday and Sunday). Before having a valid time, the update grid is unaligned. A grid offset shifts the update grid with respect to the start of the week of the [reference time standard](#). An example of usage can be found in section [Use grid offset](#).



The grid offset is not used in cyclic tracking operation.

12.2.3 Features

12.2.3.1 Communication

When PSM is enabled, communication with the receiver (e.g. UBX message to disable PSM) requires particular attention. This is because the receiver may be in *Inactive* state and therefore unable to receive any message through its interfaces. To ensure that the configuration messages are processed by the receiver, even while in *Inactive* state, the following steps need to be taken:

- Send a dummy sequence of 0xFF (one byte is sufficient) to the receiver's UART interface. This will wake up the receiver if it is in *Inactive* state. If the receiver is not in *Inactive* state, the sequence will be ignored.
- Send the configuration message about half a second after the dummy sequence. If the interval between the dummy sequence and the configuration message is too short, the receiver may not yet be ready. If the interval is too long, the receiver may return to *Inactive* state before the configuration message was received. It is therefore important to check for a [UBX-ACK-ACK](#) reply from the receiver to confirm that the configuration message was received.
- Send the configuration save message immediately after the configuration message.

Similarly, when configuring the receiver for PSMOO (and PSMCT when `doNotEnterOff` is disabled), ensure that the configurations are saved. If they are not saved the receiver will enter backup mode and when it wakes up again, it would have lost the configurations and even forgets it was in power save mode. This can be avoided by using the [UBX-CFG-CFG](#) message (see [Receiver Configuration](#) for details). When operating PSM from u-Center and setting the receiver to Power Save Mode in [UBX-CFG-RXM](#), check the save configuration box. u-Center will then send a [UBX-CFG-CFG](#) message after the [UBX-CFG-RXM](#) to save the configurations.

12.2.3.2 Wake up

The receiver can be woken up by generating an edge on one of the following pins:

- rising or falling edge on one of the EXTINT pins
- rising or falling edge on the RXD1 pin

- rising or falling edge on the SPI CS pin
- rising edge on NRESET pin

All wake-up signals are interpreted as a position request, where the receiver wakes up and tries to obtain a position fix. Wake-up signals have no effect if the receiver is already in *Acquisition*, *Tracking* or *POT* state.

12.2.3.3 Behavior while USB host connected

As long as the receiver is connected to a USB host, it will not enter the lowest possible power state. This is because it must retain a small level of CPU activity to avoid breaching requirements of the USB specification. The drawback, however, is that power consumption is higher.



Wake up by pin/UART is possible even if the receiver is connected to a USB host. In this case the state of the pin must be changed for a duration longer than one millisecond.

12.2.3.4 Cooperation with the AssistNow Autonomous feature

If both PSM and [AssistNow Autonomous](#) features are enabled, the receiver won't enter *(Inactive) Awaiting Next Fix* state as long as *AssistNow Autonomous* carries out calculations. This prevents losing data from unfinished calculations and, in the end, reduces the total extra power needed for *AssistNow Autonomous*. The delay before entering *(Inactive) Awaiting Next Fix* state, if any, will be in the range of several seconds, rarely more than 20 seconds.

Only entering *(Inactive) Awaiting Next Fix* state is affected by *AssistNow Autonomous*. In other words: in cyclic tracking operation, *AssistNow Autonomous* will not interfere with the PSM (apart from the increased power consumption).



Enabling the AssistNow Autonomous feature will lead to increased power consumption while prediction is calculated. The main goal of PSM is to reduce the overall power consumption. Therefore for each application special care must be taken to judge whether AssistNow Autonomous is beneficial to the overall power consumption or not.

12.2.4 Examples

12.2.4.1 Use Grid Offset

Scenario: Get a position fix once a day at a fixed time. If the position fix cannot be obtained try again every two hours.

Solution: First set the update period to 24*3600s and the search period to 2*3600s. Now a position fix is obtained every 24 hours and if the position fix fails retrials are scheduled in two hour intervals. As the update grid is aligned to midnight Saturday/Sunday [reference time standard](#), the position fixes happen at midnight [reference time standard](#). By setting the grid offset to 12*3600s the position fixes are shifted to once a day at noon [reference time standard](#). If the position fix at noon fails, retrials take place every two hours, the first at 14:00 [reference time standard](#). Upon successfully acquiring a position fix the next fix attempt is scheduled for noon the following day.

12.2.4.2 User controlled position fix

Scenario: Get a position fix on request.

Solution: Set updatePeriod and searchPeriod to zero. Set extintSelect to the desired EXTINT pin to be used. Enable the extintWake and extintBackup features.

12.2.4.3 Use update periods of 30 minutes

Scenario: Get a position fix once every 30 minutes and acquire a fix needed for timing products

Solution: Set mode of operation to PSMOO. Set `updatePeriod` to 1800 seconds. Set the search period to 120 seconds. Enable `waitTimeFix` feature.

12.3 Peak current settings

The peak current during acquisition can be reduced by activating the corresponding option in `UBX-CFG-PM2`. A peak current reduction will result in longer start-up times of the receiver.



This setting is independent of the activated mode (Continuous or Power Save Mode).

12.4 Power On/Off command

With message `UBX-RXM-PMREQ` the receiver can be forced to enter *Inactive* state (in Continuous and Power Save Mode). It will stay in *Inactive* state for the time specified in the message or until it is woken up by an EXTINT or activity on the RXD1, SPI CS, or NRESET pin.



Sending the message `UBX-RXM-PMREQ` while the receiver is in Power Save Mode will overrule PSM and force the receiver to enter Inactive state. It will stay in Inactive state until woken up. After wake-up the receiver continues working in Power Save Mode as configured.

12.5 EXTINT pin control when Power Save Mode is not active

The receiver can be forced OFF also when the Power Save Mode is not active. This works the same way as [EXTINT pin control in Power Save Mode](#). Just as in Power Save Mode, this feature has to be enabled and configured using `UBX-CFG-PM2`

12.6 Measurement and navigation rate with Power Save Mode

In Continuous Mode, measurement and navigation rate is configured using `UBX-CFG-RATE`. In Power Save Mode however, measurement and navigation rate can differ from the configured rates as follows:

- **Cyclic Operation:** When in state *Power Optimized Tracking*, the measurement and navigation rate is determined by the `updatePeriod` configured in `UBX-CFG-PM2`. The receiver can however switch to *Tracking* state (e.g. to download data). When in *Tracking* state, the measurement and navigation rate is as configured with `UBX-CFG-RATE`. Note: When the receiver is no longer able to produce position fixes, it can switch from Cyclic Operation to ON/OFF Operation (if this is not disabled with the `doNotEnterOff` switch in `UBX-CFG-PM2`). In that case the remarks below are relevant.
- **ON/OFF Operation:** (in [protocol versions less than 18](#)) when in state *Acquisition*, the measurement and navigation rate is **fixed to 2Hz**. All NMEA (and UBX) messages that are output upon a navigation fix are also output with a rate of 2Hz. This must be considered when choosing the baud rate of a receiver that uses Power Save Mode! Note that a receiver might stay in *Acquisition* state for quite some time (can be tens of seconds under weak signal conditions). When the receiver eventually switches to *Tracking* state, the measurement and navigation rate will be as configured with `UBX-CFG-RATE`. However, (in [protocol versions 18+](#)) the measurement and navigation rate will be as configured with `UBX-CFG-RATE` in all active states.

12.7 Power Mode Setup

(Not supported in [protocol versions less than 18](#)).

In order to simplify the power saving configuration of the receiver in typical circumstances, a set of predefined setups can be selected using the message [UBX-CFG-PMS](#).

Selecting one of the available setups (listed below) is the equivalent of using a combination of the configuration messages with appropriate parameters that impact the power consumption of the receiver.

Valid Power Mode Setup in UBX-CFG-PMS

Setup Name	Description
Full Power	No compromises on power saves
Balanced (default)	Power savings without performance degradation
Aggressive 1Hz	Best power saving setup (1Hz rate)
Aggressive 2Hz	Excellent power saving setup (2Hz rate)
Aggressive 4Hz	Good power saving setup (4Hz rate)
Interval	ON OFF mode setup

u-blox recommends using these predefined settings, except where users have very specific power saving requirements.

Note that polling UBX-CFG-PMS will return the setup only if the full configuration is consistent with one of the predefined Power Mode Setups.



In 4Hz mode, when running a flash firmware, it is recommended to run with a subset of GNSS systems, to avoid system overload.

13 Forcing a Receiver Reset

Typically, in GNSS receivers, one distinguishes between cold, warm, and hot starts, depending on the type of valid information the receiver has at the time of the restart.

- Cold start** In cold start mode, the receiver has **no** information from the last position (e.g. time, velocity, frequency etc.) at startup. Therefore, the receiver must search the full time and frequency space, and all possible satellite numbers. If a satellite signal is found, it is tracked to decode the ephemeris (18-36 seconds under strong signal conditions), whereas the other channels continue to search satellites. Once there is a sufficient number of satellites with valid ephemeris, the receiver can calculate position and velocity data. Other GNSS receiver manufacturers call this startup mode `Factory Startup`.
- Warm start** In warm start mode, the receiver has approximate information for time, position, and coarse satellite position data (Almanac). In this mode, after power-up, the receiver normally needs to download ephemeris before it can calculate position and velocity data. As the ephemeris data usually is outdated after 4 hours, the receiver will typically start with a Warm start if it has been powered down for more than 4 hours. In this scenario, several augmentations are possible. See the section on [Multi-GNSS Assistance](#).
- Hot start** In hot start mode, the receiver was powered down only for a short time (4 hours or less), so that its ephemeris is still valid. Since the receiver doesn't need to download ephemeris again, this is the fastest startup method.

In the [UBX-CFG-RST](#) message, one can force the receiver to reset and clear data, in order to see the effects of maintaining/losing such data between restarts. For this, the CFG-RST message offers the `navBbrMask` field, where hot, warm and cold starts can be initiated, and also other combinations thereof.



Data stored in flash memory is not cleared by any of the options provided by UBX-CFG-RST. So, for example, if valid AssistNow Offline data stored in the flash it is likely to have an impact on a "cold start".

The Reset Type can also be specified. This is not related to GNSS, but to the way the software restarts the system.

- **Hardware Reset** uses the on-chip Watchdog, in order to electrically reset the chip. This is an immediate, asynchronous reset. No Stop events are generated. This is equivalent to pull the Reset signal of the receiver to ground.
- **Controlled Software Reset** terminates all running processes in an orderly manner and, once the system is idle, restarts operation, reloads its configuration and starts to acquire and track GNSS satellites.
- **Controlled Software Reset (GNSS only)** only restarts the GNSS tasks, without reinitializing the full system or reloading any stored configuration.
- **Controlled GNSS Stop** stops all GNSS tasks. The receiver will not be restarted, but will stop any GNSS related processing.
- **Controlled GNSS Start** starts all GNSS tasks.

14 Receiver Status Monitoring

Messages in the UBX class [MON](#) are used to report the status of the parts of the embedded computer system that are not GNSS specific.

The main purposes are

- Hardware and Software Versions, using [MON-VER](#). See also the chapter [decoding the output of UBX-MON-VER](#)
- Status of the Communications Input/Output system
- Status of various Hardware Sections with [MON-HW](#)

14.1 Input/Output system

The I/O system is a GNSS-internal layer where all data input- and output capabilities (such as UART, DDC, SPI, USB) of the GNSS receiver are combined. Each communications task has buffers assigned, where data is queued. For data originating at the receiver, to be communicated over one or multiple communications queues, the message [MON-TXBUF](#) can be used. This message shows the current and maximum buffer usage, as well as error conditions.



If the amount of data configured is too much for a certain port's bandwidth (e.g. all UBX messages output on a UART port with a baud rate of 9600), the buffer will fill up. Once the buffer space is exceeded, new messages to be sent will be dropped. For details see section [Serial Communication Ports Description](#)

Inbound data to the GNSS receiver is placed in buffers. Usage of these buffers is shown with the message [MON-RXBUF](#). Further, as data is then decoded within the receiver (e.g. to separate UBX and NMEA data), the [MON-MSGPP](#) can be used. This message shows (for each port and protocol) how many messages were successfully received. It also shows (for each port) how many bytes were discarded because they were not in any of the supported protocol framings.

The following table shows the port numbers used. Note that any numbers not listed are reserved for future use.

Port Number assignment

Port #	Electrical Interface
0	DDC (I ² C compatible)
1	UART 1
3	USB
4	SPI

Protocol numbers range from 0-7. All numbers not listed are reserved.

Protocol Number assignment

Protocol #	Protocol Name
0	UBX Protocol
1	NMEA Protocol
2	RTCM Protocol

14.2 Jamming/Interference Indicator

The field `jamInd` of the `UBX-MON-HW` message can be used as an indicator for continuous wave (narrowband) jammers/interference only. The interpretation of the value depends on the application. It is necessary to run the receiver in an unjammed environment to determine an appropriate value for the unjammed case. If the value rises significantly above this threshold, this indicates that a continuous wave jammer is present.

This indicator is always enabled.

The indicator is reporting any currently detected narrowband interference over all currently configured signal bands

14.3 Jamming/Interference Monitor (ITFM)

The field `jammingState` of the `MON-HW` message can be used as an indicator for both broadband and continuous wave (CW) jammers/interference. It is independent of the (CW only) jamming indicator described in [Jamming/Interference Indicator](#) above.

This monitor reports whether jamming has been detected or suspected by the receiver. The receiver monitors the background noise and looks for significant changes. Normally, with no interference detected, it will report 'OK'. If the receiver detects that the noise has risen above a preset threshold, the receiver reports 'Warning'. If in addition, there is no current valid fix, the receiver reports 'Critical'.

The monitor has four states as shown in the following table:

Jamming/Interference monitor reported states

Value	Reported state	Description
0	Unknown	Jamming/interference monitor not enabled, uninitialized or antenna disconnected
1	OK	no interference detected
2	Warning	position ok but interference is visible (above the thresholds)
3	Critical	no reliable position fix and interference is visible (above the thresholds); interference is probable reason why there is no fix

The monitor is disabled by default. The monitor is enabled by sending an appropriate `UBX-CFG-ITFM` message with the `enable` bit set. In this message it is also possible to specify the thresholds at which broadband and CW jamming are reported. These thresholds should be interpreted as the dB level above 'normal'. It is also possible to specify whether the receiver expects an active or passive antenna.



The monitor algorithm relies on comparing the currently measured spectrum with a reference from when a good fix was obtained. Thus the monitor will only function when the receiver has had at least one (good) first fix, and will report 'Unknown' before this time.



Jamming/Interference monitor is not supported in Power Save Mode (PSM) ON/OFF mode.

The monitor is reporting any currently detected interference over all currently configured signal bands

15 Spoofing Detection

(Note: this feature is not supported in [protocol versions less than 18](#)).

15.1 Introduction

Spoofing is the process whereby someone tries to forge a GNSS signal with the intention of fooling the receiver into calculating a different user position than the true one.

The spoofing detection feature monitors the GNSS signals for suspicious patterns indicating that the receiver is being spoofed. A flag in [UBX-NAV-STATUS](#) alerts the user to potential spoofing.

15.2 Scope

The spoofing detection feature monitors suspicious *changes* in the GNSS signal indicating external manipulation. Therefore the detection is only successful when the signal is genuine first and when the transition to the spoofed signal is being observed directly. When a receiver is started up to a spoofed signal the detection algorithms will be unable to recognize the spoofing. Also, the algorithms rely on availability of signals from multiple GNSS; the detection does not work in single GNSS mode.

16 Signal Attenuation Compensation

(not supported in [protocol versions less than 19](#)).

In normal operating conditions, low signal strength indicates likely contamination by multipath. The receiver trusts such signals less in order to preserve the quality of the position solution in poor signal environments. This feature can result in degraded performance in situations where the signals are attenuated for another reason, for example due to antenna placement. In this case, the signal attenuation compensation feature can be used to restore normal performance.

There are three possible modes:

- Disabled: no signal attenuation compensation is performed
- Automatic: the receiver automatically estimates and compensates for the signal attenuation
- Configured: the receiver compensates for the signal attenuation based on a configured value

These modes can be selected using [UBX-CFG-NAVX5](#). In the case of the "configured" mode, the user should input the maximum C/N0 observed in a clear-sky environment, excluding any outliers or unusually high values. The configured value can have a large impact on the receiver performance, so should be chosen carefully.

17 Remote Inventory

17.1 Description

The *Remote Inventory* enables storing user-defined data in the non-volatile memory of the receiver. The data can be either binary or a string of ASCII characters. In the second case, it will be output at startup after the boot screen.

17.2 Usage

- The contents of the *Remote Inventory* can be set and polled with the message [UBX-CFG-RINV](#). Refer to the message specification for a detailed description.
- If the contents of the *Remote Inventory* are polled without having been set before, the default configuration (see table below) is output.

Default configuration

Parameter	Value
flags	0x00
data	"Notice: no data saved!"



As with all configuration changes, these must be saved in order to be made permanent. Make sure to save the section *RINV* before resetting or switching off the receiver. For more information about saving a configuration, see section [Configuration Concept](#).

18 Time pulse



For protocol versions less than 18, functionality of the time pulse has not been characterized when only BeiDou is enabled.



The time pulse feature is not available for protocol versions 23-23.01.

18.1 Introduction

u-blox receivers include a time pulse function providing clock pulses with configurable duration and frequency. The time pulse function can be configured using the `UBX-CFG-TP5` message. The `UBX-TIM-TP` message provides time information for the next pulse, time source and the quantization error of the output pin.

Pulse Mode: Rising



Pulse Mode: Falling

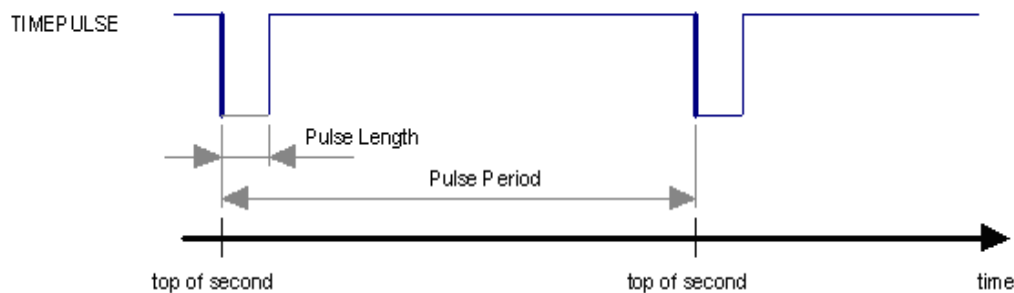

18.2 Recommendations

- The time pulse can be aligned to a wide variety of GNSS times or to variants of UTC derived from them (see the section on [time bases](#)). However, it is strongly recommended that the choice of time base is aligned with the available GNSS signals (so to produce GPS time or UTC(USNO), ensure GPS signals are available, and for GLONASS time or UTC(SU) ensure the presence GLONASS signals). This will involve coordinating that the setting of `UBX-CFG-GNSS` with the choice of time pulse time base.
- For best time pulse performance it is recommended to disable the SBAS subsystem.
- When using time pulse for precision timing applications it is recommended to calibrate the antenna cable delay against a reference-timing source.
- Care needs to be given to the cable delay settings in the receiver configuration.

- In order to get the best timing accuracy with the antenna, a fixed and *accurate* position is needed.
- If relative time accuracy between multiple receivers is required, do not mix receivers of different product families. If this is required, the receivers must be calibrated accordingly, by setting cable delay and user delay.
- The recommended configuration when using the `UBX-TIM-TP` message is to set both the measurement rate (`UBX-CFG-RATE`) and the time pulse frequency (`UBX-CFG-TP5`) to 1Hz.



Since the rate of `UBX-TIM-TP` is bound to the measurement rate, more than one `UBX-TIM-TP` message can appear between two pulses if the measurement rate is set larger than the time pulse frequency. In this case all `UBX-TIM-TP` messages in between a time pulse $T1$ and $T2$ belong to $T2$ and the last `UBX-TIM-TP` before $T2$ reports the most accurate quantization error. In general, if the navigation solution rate and time pulse rate are configured to different values, there will not be a single `UBX-TIM-TP` message for each time pulse.

The sequential order of the signal present at the TIMEPULSE pin and the respective output message for the simple case of 1 pulse per second (1PPS) and a one second navigation update rate is shown in the following figure.

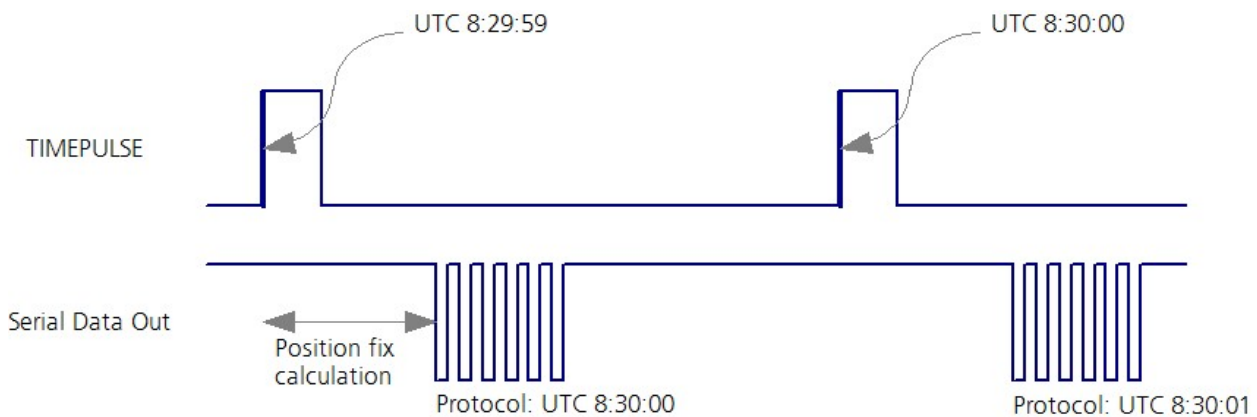

18.3 GNSS time bases

GNSS receivers must handle a variety of different time bases as each GNSS has its own reference system time. What is more, although each GNSS provides a model for converting their system time into UTC, they all support a slightly different variant of UTC. So, for example, GPS supports a variant of UTC as defined by the US National Observatory, while BeiDou uses UTC from the National Time Service Center, China (NTSC). While the different UTC variants are normally closely aligned, they can differ by as much as a few hundreds of nanoseconds.

Although u-blox receivers can combine a variety of different GNSS times internally, the user must choose a single type of GNSS time and, separately, a single type of UTC for input (on EXTINTs) and output (via the Time Pulse) and the parameters reported in corresponding messages.

For [protocol versions 16 or greater](#), the `UBX-CFG-TP5` message allows the user to choose between any of the supported GNSS (GPS, GLONASS, BeiDou, etc) times and UTC. Also, the `UBX-CFG-NAV5` message allows the user to select which variant of UTC the receiver should use. This includes an "automatic" option which causes the receiver to select an appropriate UTC version itself, based on the [GNSS configuration](#), using, in order of preference, USNO if GPS is enabled, SU if GLONASS is enabled, NTSC if BeiDou is enabled and, finally, European if Galileo is enabled.

Note that for [protocol versions prior to 16](#), no choice of UTC variant is supported and the `UBX-CFG-TP5` message only allows the user to choose between GPS and UTC as the time system the generated time pulse will be aligned to.

The receiver will assume that the input time pulse uses the same GNSS time base as specified for the output using `UBX-CFG-TP5`. So if the user selects GLONASS time for time pulse output, any time pulse input must also be aligned to GLONASS time (or to the separately chosen variant of UTC). Where UTC is selected for time pulse output, any GNSS time pulse input will be assumed to be aligned to GPS time.



u-blox receivers allow users to choose independently GNSS signals used in the receiver (using `UBX-CFG-GNSS`) and the input/output time base (using `UBX-CFG-TP5`). For example it is possible to instruct the receiver to use GPS and GLONASS satellite signals to generate BeiDou time. This practice will compromise time-pulse accuracy if the receiver cannot measure the timing difference between the constellations directly and is not recommended.



The information that allows GNSS times to be converted to the associated UTC times is only transmitted by the GNSS at relatively infrequent periods. For example GPS transmits UTC(USNO) information only once every 12.5 minutes. Therefore, if a Time Pulse is configured to use a variant of UTC time, after a cold start, substantial delays before the receiver has sufficient information to start outputting the Time Pulse can be expected.

18.4 Time pulse configuration

u-blox receivers provide one or two TIMEPULSE pins (dependent on product variant) delivering a time pulse (TP) signal with a configurable pulse period, pulse length and polarity (rising or falling edge). Check the product data sheet for detailed specification of configurable values.

It is possible to define different signal behavior (i.e. output frequency and pulse length) depending on whether or not the receiver is locked to a reliable time source. Time pulse signals can be configured using the UBX proprietary message `UBX-CFG-TP5`.

18.5 Configuring time pulse with UBX-CFG-TP5

The UBX message `UBX-CFG-TP5` can be used to change the time pulse settings, and includes the following parameters defining the pulse:

- **time pulse index** - Index of time pulse output pin to be configured. If a product only has one time pulse output it is typically configurable with index 0. Exceptions to this include LEA-M8F, M8030-KT-FT and NEO-M8L. Please refer to specific product documentation.
- **antenna cable delay** - Signal delay due to the cable between antenna and receiver.
- **RF group delay** - Signal delay in the RF module of the receiver (read-only).
- **pulse frequency/period** - Frequency or period time of the pulse when locked mode is not configured or active.
- **pulse frequency/period lock** - Frequency or period time of the pulse, as soon as receiver has calculated a valid time from a received signal. Only used if the corresponding flag is set to use another setting in locked mode.
- **pulse length/ratio** - Length or duty cycle of the generated pulse, either specifies a time or ratio for the pulse to be on/off.
- **pulse length/ratio lock** - Length or duty cycle of the generated pulse, as soon as receiver has calculated a valid time from a received signal. Only used if the corresponding flag is set to use another setting in locked mode.
- **user delay** - The cable delay from the receiver to the user device plus signal delay of any user application.
- **active** - time pulse will be active if this bit is set.
- **lock to gps freq** - Use frequency gained from GPS signal information rather than local oscillator's frequency

if flag is set.

- **lock to gnss freq** - Use frequency gained from GNSS signal information rather than local oscillator's frequency if flag is set.
- **locked other setting** - If this bit is set, as soon as the receiver can calculate a valid time, the alternative setting is used. This mode can be used for example to disable time pulse if time is not locked, or indicate lock with different duty cycles.
- **is frequency** - Interpret the 'Frequency/Period' field as frequency rather than period if flag is set.
- **is length** - Interpret the 'Length/Ratio' field as length rather than ratio if flag is set.
- **align to TOW** - If this bit is set, pulses are aligned to the top of a second.
- **polarity** - If set, the first edge of the pulse is a rising edge (Pulse Mode: Rising).
- **grid UTC/GPS** - Selection between UTC (0) or GPS (1) timegrid. Also effects the time output by [UBX-TIM-TP](#) message.
- **grid UTC/GNSS** - Selection between UTC (0), GPS (1), GLONASS (2) and Beidou (3) timegrid. Also effects the time output by [UBX-TIM-TP](#) message.



The maximum pulse length can't exceed the pulse period.



Time pulse settings shall be chosen in such a way, that neither the high nor the low period of the output is less than 50 ns (except when disabling it completely), otherwise pulses can be lost.



The maximum frequency of the second time pulse pin (TIMEPULSE2) is limited to 1kHz for [protocol versions less than 18](#) unless using a Timing product variant.

18.5.1 Example 1

The example below shows the 1PPS TP signal generated on the time pulse output according to the specific parameters of the [UBX-CFG-TP5](#) message:

- **tpIdx** = 0
- **freqPeriod** = 1 s
- **pulseLenRatio** = 100 ms
- **active** = 1
- **lockGpsFreq** = **lockGnssFreq** = 1
- **isLength** = 1
- **alignToTow** = 1
- **polarity** = 1
- **gridUtcGps** = **gridUtcGnss** = 1

The 1 Hz output is maintained whether or not the receiver is locked to GPS time. The alignment to TOW can only be maintained when GPS time is locked.

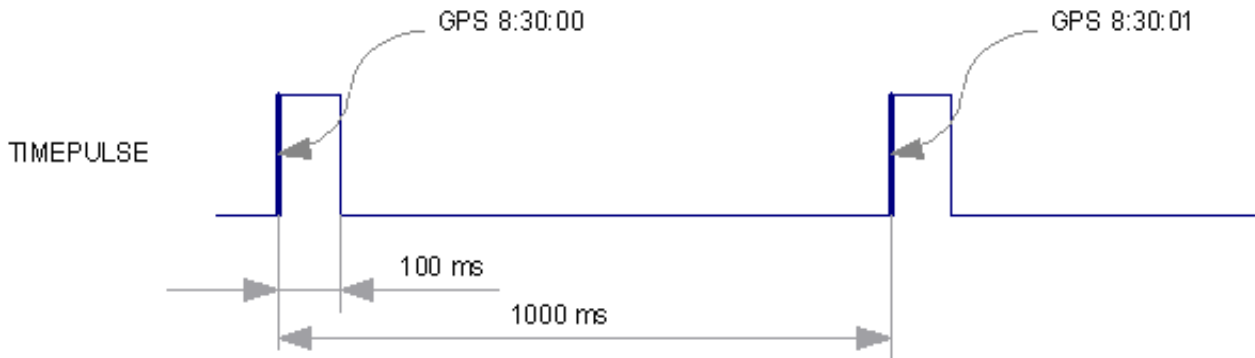

18.5.2 Example 2

This example only works with a Timing product variant or for [protocol versions greater than 17](#).

The following example shows a 10 MHz TP signal generated on the TIMEPULSE2 output when the receiver is locked to GPS time. Without the lock to GPS time no frequency is output.

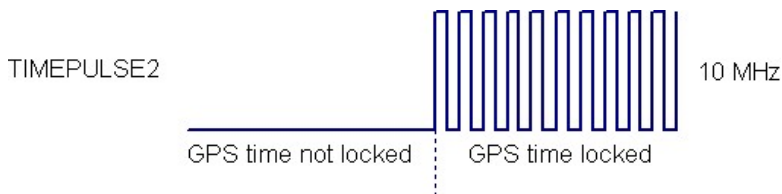

- **tpIdx** = 1
- **freqPeriod** = 1 Hz
- **pulseLenRatio** = 0
- **freqPeriodLock** = 10 MHz
- **pulseLenRatioLock** = 50%
- **active** = 1
- **lockGpsFreq** = **lockGnssFreq** = 1
- **lockedOtherSet** = 1
- **isFreq** = 1
- **alignToTow** = 1
- **polarity** = 1
- **gridUtcGps** = **gridUtcGnss** = 1

19 Timemark

The receiver can be used to provide an accurate measurement of the time at which a pulse was detected on the external interrupt pin. The reference time can be chosen by setting the time source parameter to UTC, GPS, GLONASS, BeiDou, Galileo or local time in the [UBX-CFG-TP5](#) configuration message. The UTC standard can be set in the [UBX-CFG-NAV5](#) configuration message. The delay figures defined with [UBX-CFG-TP5](#) are also applied to the results output in the [UBX-TIM-TM2](#) message.

A [UBX-TIM-TM2](#) message is output at the next epoch if

- the [UBX-TIM-TM2](#) message is enabled
- a rising or falling edge was triggered since last epoch on one of the EXTINT channels

The `UBX-TIM-TM2` messages include time of the last timemark, new rising/falling edge indicator, time source, validity, number of marks and a quantization error. The timemark is triggered continuously.



Only the last rising and falling edge detected between two epochs is reported since the output rate of the `UBX-TIM-TM2` message corresponds to the measurement rate configured with `UBX-CFG-RATE` (see Figure below).

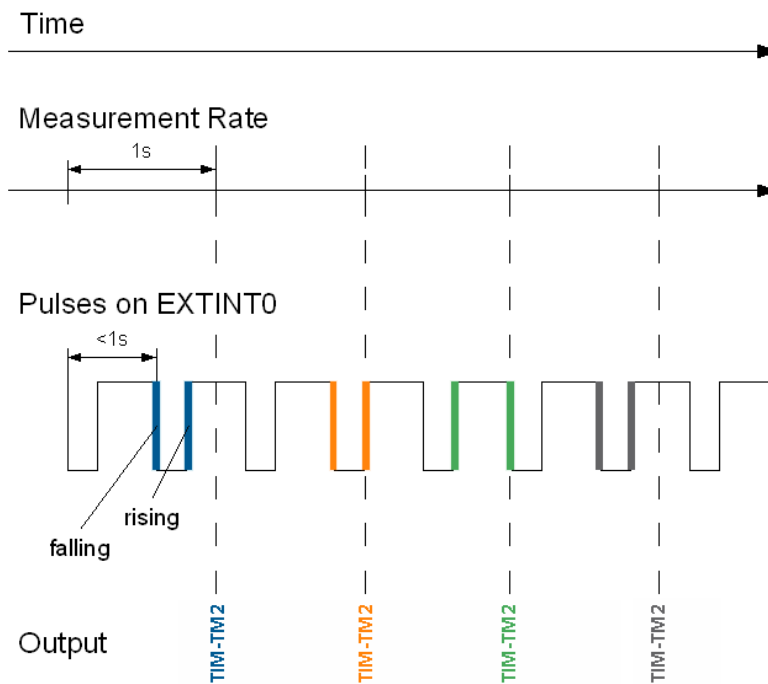

20 Odometer

20.1 Introduction

The odometer provides information on travelled ground distance (in meter) using solely the position and Doppler-based velocity of the navigation solution. For each computed travelled distance since the last odometer reset, the odometer estimates a 1-sigma accuracy value. The total cumulative ground distance is maintained and saved in the BBR memory.



The odometer feature is disabled by default. It can be enabled using the `UBX-CFG-ODO` message.

20.2 Odometer Output

The odometer output is published in the `UBX-NAV-ODO` message. This message contains the following elements:

- *Ground distance since last reset* (`distance` field): this distance is defined as the total cumulated distance in meters since the last time the odometer was reset (see section [Resetting the Odometer](#));
- *Ground distance accuracy* (`distanceStd` field): this quantity is defined as the 1-sigma accuracy estimate (in meters) associated to the *Ground distance since last reset* value;
- *Total cumulative ground distance* (`totalDistance` field): this quantity is defined as the total cumulated distance

in meters since the last time the receiver was cold started (see section [Resetting the Odometer](#)).

If logging is enabled, then the odometer's *ground distance since last reset* value will be included in the logged position data (see section [Logging](#)).

20.3 Odometer Configuration

The odometer can be enabled/disabled by setting the appropriate flag in `UBX-CFG-ODO` (*flags* field). The algorithm behaviour can be optimized by setting up a profile (*odoCfg* field) representative of the context in which the receiver is operated. The implemented profiles together with their meanings are listed below:

- *Running*: the algorithm is optimized for typical dynamics encountered while running, i.e the Doppler-based velocity solution is assumed to be of lower quality;
- *Cycling*: the algorithm is optimized for typical dynamics encountered while cycling;
- *Swimming*: the algorithm is optimized for very slow and smooth trajectories typically encountered while swimming;
- *Car*: the algorithm assumes that good Doppler measurements are available (i.e. the antenna is subject to low vibrations) and is optimized for typical dynamics encountered by cars.



The odometer can only be reliably operated in a swimming context if satellite signals are available and the antenna is not immersed.

20.4 Resetting the Odometer

The odometer outputs (see `UBX-NAV-ODO` message) can be reset by the following means:

- *Ground distance since last reset* (*distance* field): by sending a `UBX-NAV-RESETODO` message;
- *Ground distance accuracy* (*distanceStd* field): by sending a `UBX-NAV-RESETODO` message;
- *Total cumulative ground distance* (*totalDistance*): by a cold start of the receiver (this erases the BBR memory);

21 Logging

21.1 Introduction

The logging feature allows position fixes and arbitrary byte strings from the host to be logged in flash memory attached to the receiver. Logging of position fixes happens independently of the host system, and can continue while the host is powered down.

The following tables list all the logging related messages:

Logging control and configuration messages

Message	Description
<code>UBX-LOG-CREATE</code>	Creates a log file and activates the logging subsystem
<code>UBX-LOG-ERASE</code>	Erases a log file and deactivates the logging subsystem
<code>UBX-CFG-LOGFILTER</code>	Used to start/stop recording and set/get the logging configuration
<code>UBX-LOG-INFO</code>	Provides information about the logging system
<code>UBX-LOG-STRING</code>	Enables a host process to write a string of bytes to the log file

Logging retrieval messages

Message	Description
<code>UBX-LOG-RETRIEVE</code>	Starts the log retrieval process
<code>UBX-LOG-RETRIEVEPOS</code>	A position log entry returned by the receiver

Logging retrieval messages continued

Message	Description
UBX-LOG-RETRIEVEPOSEXT RA	Odometer position data
UBX-LOG-RETRIEVESTRING	A byte string log entry returned by the receiver
UBX-LOG-FINDTIME	Finds the index of the first entry <= given time

21.2 Setting the logging system up

An empty log can be created using the [UBX-LOG-CREATE](#) message and a log can be deleted with the [UBX-LOG-ERASE](#) message. The logging system will only be running if a log is in existence, so most logging messages will be rejected with an [UBX-ACK-NAK](#) message if there is no log present. Only one log can be created at any one time so an [UBX-ACK-NAK](#) message will be returned if a log already exists. The message specifies the maximum size of the log in bytes (with some pre-set values provided). Both the logging subsystem and the receiver file-store have implementation overheads, so total space available for log entries will be somewhat smaller than the size specified.

[UBX-LOG-CREATE](#) also allows the log to be specified as a circular log. If the log is circular, then when it fills up, a set of older log entries will be deleted and the space freed up used for new log entries. By contrast, if a non-circular log becomes full then new entries which don't fit will be rejected. [UBX-LOG-CREATE](#) also causes the logging system to start up so that further logging messages can be processed. The logging system will start up automatically on power-up if there is a log in existence. The log will remain in the receiver until specifically erased using the [UBX-LOG-ERASE](#) message.

[UBX-CFG-LOGFILTER](#) controls whether logging of entries is currently enabled and selects position fix messages for logging. These configuration settings will be saved if the configuration is saved to flash. If this is done, then entry logging will continue on power-up in the same manner that it did before power-down.

The top level active/inactive states of the logging subsystem.

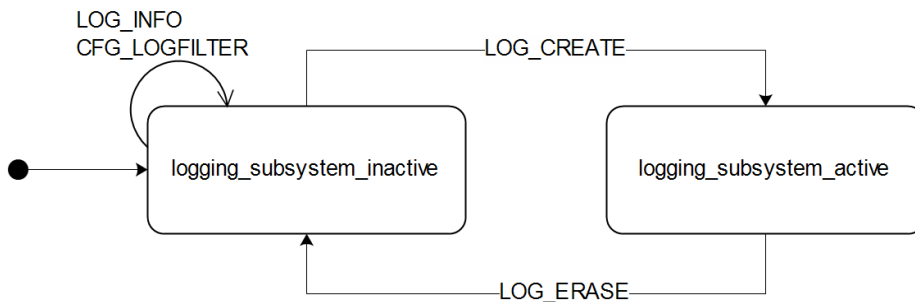

21.3 Information about the log

The receiver can be polled for a [UBX-LOG-INFO](#) message which will give information about the log. This will include the maximum size that the log can grow to (which, due to overheads, will be smaller than that requested in [UBX-LOG-CREATE](#)) and the amount of log space currently occupied. It will also report the number of entries currently in the log together with the time and date of the newest and oldest messages which have a valid time stamp.

Log entries are compressed and have housekeeping information associated with them, so the actual space occupied by log messages may be difficult to predict. The minimum size for a position fix entry is 9 bytes and the maximum 24 bytes, the typical size is 10 or 11 bytes. If the odometer is enabled then this will use at least another three bytes per fix.

Each log also has a fixed overhead which is dependent on the log type. The approximate size of this overhead is

shown in the following table.

Log overhead size

Log type	Overhead
circular	Up to 40 kB
non-circular	Up to 8 kB

The number of entries that can be logged in any given flash size can be estimated as follows:

Approx. number of entries = (flash size available for logging - log overhead) / typical entry size

For example, if 1500 kB of flash is available for logging (after other flash usage such as the firmware image is taken into account) a non-circular log would be able to contain approximately 139000 entries $((1500 * 1024) - (8 * 1024)) / 11 = 138891$.

21.4 Recording

The `UBX-CFG-LOGFILTER` message specifies the conditions under which entries are recorded. Nothing will be recorded if recording is disabled, otherwise position fix and `UBX-LOG-STRING` entries can be recorded. When recording is enabled an entry will also be created from each `UBX-LOG-STRING` message. These will be timestamped if the receiver has current knowledge of time.

The `UBX-CFG-LOGFILTER` message has several values which can be used to select position fix entries for logging. If all of these values are zero, then all position fixes will be logged (subject to a maximum rate of 1Hz). A position is logged if any of the thresholds are exceeded. If a threshold is set to zero it is ignored. In addition the position difference and current speed thresholds also have a minimum time threshold.

Position fixes are only recorded if a valid fix is obtained - failed and invalid fixes are not recorded.

Position fixes are compressed to economise on the amount of flash space used. In order to improve the compression, the fix values are rounded to improve their compression. This means that the values returned by the logging system may differ slightly from any which are gathered in real time.

In `On/Off Power Save Mode` it is possible to configure the logging system so that only one fix is recorded for each on period. This will be recorded immediately before the receiver powers off and will be the best fix seen during the on period (in this case, "best" is defined as being the fix with the lowest horizontal accuracy figure).

The recorded data for a fix comprises :

- The time and date of the fix recorded to a precision of one second
- Latitude and longitude to a precision of one millionth of a degree. Depending on position on Earth this is a precision in the order of 0.1m
- Altitude (height above mean sea level) to a precision of 1m
- Ground speed to a precision of 1cm/s
- The fix type (only successful fix types, since these are the only ones recorded)
- The number of satellites used in the fix is recorded, but no value greater than 19 is logged; a value of 19 means 19 or more satellites
- A horizontal accuracy estimate is recorded to give an indication of fix quality
- Heading to a precision of one degree
- Odometer distance data (if odometer is enabled)

The states of the active logging subsystem

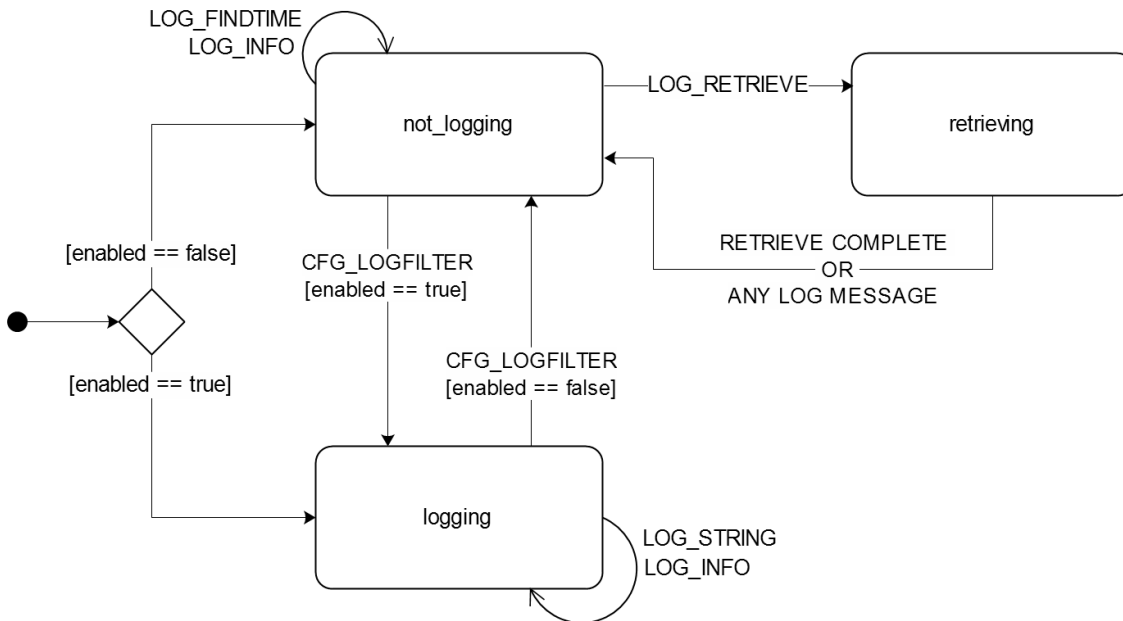

21.5 Retrieval

UBX-LOG-RETRIEVE starts the process which allows the receiver to output log entries. Log recording must be stopped using **UBX-CFG-LOGFILTER** before this can be done. **UBX-LOG-INFO** may be helpful to a host system in order to understand the current log status before retrieval is started.

Once retrieval has started, one message will be output from the receiver for each log entry requested. Sending any logging message to the receiver during retrieval will cause the retrieval to stop before the message is processed.

To maximise the speed of transfer it is recommended that a high communications data rate is used and GNSS processing is stopped during the transfer (see **UBX-CFG-RST**)

UBX-LOG-RETRIEVE can specify a start-entry index and entry-count. The maximum number of entries that can be returned in response to a single **UBX-LOG-RETRIEVE** message is 256. If more entries than this are required the message will need to be sent multiple times with different startEntry indices.

The receiver will send a **UBX-LOG-RETRIEVEPOS** message for each position fix log entry and a **UBX-LOG-RETRIEVESTRING** message for each string log entry. If the odometer was enabled at the time a position was logged, then a **UBX-LOG-RETRIEVEPOSEXTRA** will also be sent. Messages will be sent in the order in which they were logged, so **UBX-LOG-RETRIEVEPOS** and **UBX-LOG-RETRIEVESTRING** messages may be interspersed in the message stream.

The **UBX-LOG-FINDTIME** message can be used to search a log for the index of the first entry less than or equal to the given time. This index can then be used with the **UBX-LOG-RETRIEVE** message to provide time-based retrieval of log entries.

21.6 Command message acknowledgement

Some log operations may take a long time to execute because of the time taken to write to flash memory. The time for some operations may be unpredictable since the number and timing of flash operations may vary. In order to allow host software to synchronise to these delays logging messages will always produce a response. This will be **UBX-ACK-NAK** in case of error, otherwise **UBX-ACK-ACK** unless there is some other defined response to the message.

It is possible to send a small number of logging commands without waiting for acknowledgement, since there is a command queue, but this risks confusion between the acknowledgements for the commands. Also a command queue overflow would result in commands being lost.

22 Geofencing

(Note: this feature is not supported in [protocol versions less than 18](#)).

22.1 Introduction

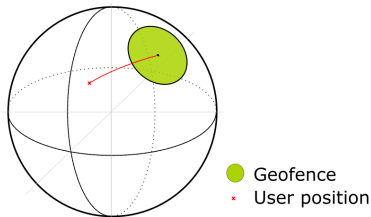

The geofencing feature allows for the configuration of up to four circular areas (geofences) on the Earth's surface. The receiver will then evaluate for each of these areas whether the current position lies within the area or not and signal the state via UBX messaging and PIO toggling.

22.2 Interface

Geofencing can be configured using the [UBX-CFG-GEOFENCE](#) message. The geofence evaluation is active whenever there is at least one geofence configured.

The current state of each geofence plus the combined state is output in [UBX-NAV-GEOFENCE](#) with every navigation epoch.

Additionally the user can configure the receiver to output the combined geofence state on a physical pin.

22.3 Geofence state evaluation

With every navigation epoch the receiver will evaluate the current solution's position versus the configured geofences. There are three possible outcomes for each geofence:

- *Inside* - The position is inside the geofence with the configured confidence level
- *Outside* - The position lies outside of the geofence with the configured confidence level
- *Unknown* - There is no valid position solution or the position uncertainty does not allow for unambiguous state evaluation

The position solution uncertainty (standard deviation) is multiplied with the configured confidence sigma level number and taken into account when evaluating the geofence state (red circle in figure below).

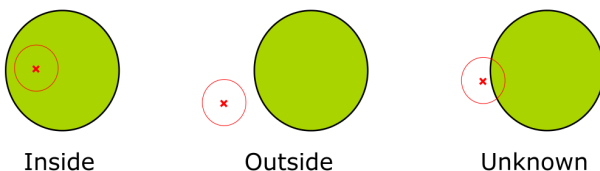

The combined state for all geofences is evaluated as the combination (logical OR) of all geofences:

- *Inside* - The position lies inside of at least one geofence
- *Outside* - The position lies outside of all geofences
- *Unknown* - All remaining states

22.4 Using a PIO for Geofence State Output

This feature can be used for example for waking up a sleeping host when a defined geofence condition is reached. The receiver will toggle the assigned pin according to the *combined* geofence state. Due to hardware restrictions the unknown state will always be represented as HIGH. If the receiver is in software backup or in a reset, the pin will go to HIGH accordingly. The meaning of the LOW state can be configured using [UBX-CFG-GEOFENCE](#).

23 Host Interface Signature Description

23.1 Introduction

The host interface signature feature is designed to help to detect 3rd party attempts to tamper with position and/or time in the host communication channel (i.e. UART).

The level of security of such mechanism depends on how the final system is designed. The feature itself cannot guarantee that the system is secure if the host, the final system HW, and the production setup are not secure.

The feature works by the receiver calculating a numerical signature for the configured messages. The system receiving the message can verify the signature based on the message content and the configured value, termed "seed".

Two new messages are provided for configuring the seed used for the signing: [UBX-CFG-FIXSEED](#) and [UBX-CFG-DYNSEED](#).

23.2 Configuring the Fixed Seed and Register Messages

In the [UBX-CFG-FIXSEED](#) message the fixed seed and the set of UBX messages to be signed can be configured.



At least one message has to be registered and a maximum of 10 messages are supported.



Configuring the set of messages that are signed will not enable these messages by default.



All UBX messages can be signed.



This message can only be sent once to the receiver. All subsequent messages will result in a NAK answer.

23.3 Configuring the Dynamic Seed

In the [UBX-CFG-DYNSEED](#) message an additional seed can be configured to make a replay attack more difficult. This form of attack stores the messages received from the receiver for a certain time and replays them later.

To prevent such an attack the host can use the time information from the receiver or a dynamic seed. This generates a random seed at regular intervals that is then used by the receiver to sign the outgoing messages.

The frequency of the update on the dynamic seed has to be configured depending on the security concept of the whole system. In case the interval is too long the attacker can store the first set of messages and replay them during the whole period until a new seed is generated. The recommended interval would be in the range of some seconds to a few minutes.



By default the dynamic seed is set to 0x0000_0000_0000_0000.



While programming the dynamic seed the receiver may still send signatures which are based on the old seed.

23.4 Parsing the Signature

The `UBX-SEC-SIGN` message contains the signature of a previously transmitted message and is **always** sent after the related message. It is not guaranteed that between the message and the signature no other messages are output.

The payload of `UBX-SEC-SIGN` contains the reference to the signed message. It can be used to match the related message using the class ID, the message ID and the UBX checksum of the related message. This means that a previously transmitted message is signed when the class ID, the message ID and the UBX checksum match.

23.5 Calculate the Hash

The picture below shows the layout of the buffer over which the SHA-256 hash is calculated.

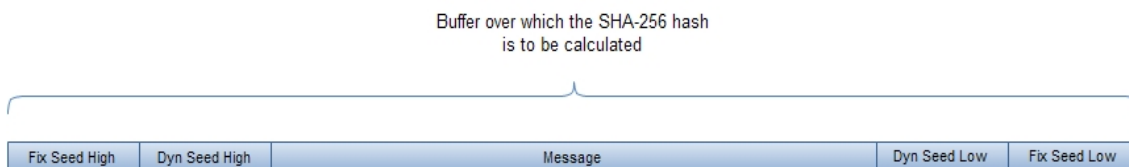

The result is a 256 bit (32 bytes) hash which needs to be verified with the content (field *hash*) of the corresponding `UBX-SEC-SIGN` message.

24 Time Mode Configuration



This feature is only available with Timing, FTS or High Precision GNSS (HPG) products

This section relates to the configuration message `UBX-CFG-TMODE2` (for Timing or FTS products) and to the configuration message `UBX-CFG-TMODE3` (for HPG products).

24.1 Introduction

Time Mode is a special receiver mode where the position of the receiver is known and fixed and only the time is calculated using all available satellites. This mode allows for maximum time accuracy, for single-SV solutions, and also for using the receiver as a stationary reference station.

24.2 Fixed Position

In order to use the *Time Mode*, the receiver's position must be known as exactly as possible. Either the user already knows and enters the position, or it is determined using [Survey-in](#). Errors in the fixed position will translate into time errors depending on the satellite constellation.

For Timing products, as a rule of thumb the position should be known with an accuracy of better than 1 m for a timing accuracy in the order of nanoseconds. If an accuracy is required only in the order of microseconds, a position accuracy of roughly 300 m is sufficient.

For HPG products, errors in the reference station position will directly translate into rover position errors. The reference station position accuracy should therefore be at least as good as the desired rover absolute position accuracy.

24.3 Survey-in

Survey-in is the procedure that is carried out prior to using *Time Mode*. It determines a stationary receiver's position by building a weighted mean of all valid 3D position solutions.

Two requirements for stopping the procedure must be specified:

- The **minimum observation time** defines a minimum amount of observation time regardless of the actual number of valid fixes that were used for the position calculation. Reasonable values range from one day for high accuracy requirements to a few minutes for coarse position determination.
- The **required 3D position standard deviation** defines a limit on the spread of positions that contribute to the calculated mean. As the position error translates into a time error when using *Time Mode* (see [above](#)), one should carefully evaluate the time accuracy requirements and choose an appropriate value.

Survey-in ends, when **both** requirements are met. After Survey-in has finished successfully, the receiver will automatically enter fixed position *Time Mode*. The Survey-in status can be queried using the `UBX-TIM-SVIN` message for Timing or FTS products or the `UBX-NAV-SVIN` message for HPG products.



The "Standard Deviation" parameter defines uncertainty of the manually provided "True Position" set of parameters. This uncertainty directly affects the accuracy of the timepulse. This is to prevent an error that would otherwise be present in the timepulse because of the initially inaccurate position (assumed to be correct by the receiver) without users being aware of it. The "3D accuracy" parameter in "Fixed Position" as well as the "Position accuracy limit" in "Survey-in" affect the produced time information and the timepulse in the same way. Please note that the availability of the position accuracy does not mitigate the error in the timepulse but only accounts for it when calculating the resulting time accuracy.



Once a survey-in has been started, its progress is saved in non-volatile memory, and hence continues over events such as a reset, receiver restart, or change of satellite constellation. If a survey-in position is required using data only for a particular receiver configuration, then any on-going survey-in should be stopped by either a `UBX-CFG-TMODE2` or a `UBX-CFG-TMODE3` message with the `timeMode` field set to 0, then the receiver configured as required, and then a new `UBX-CFG-TMODE2` or `UBX-CFG-TMODE3` message sent with the new survey-in parameters.

25 Time & Frequency Sync (FTS)



The features described in this section are only available with the FTS products

25.1 Introduction

An FTS configured receiver provides an accurate, low phase-noise reference frequency as well as phase reference pulse (typically at one pulse per second). An FTS receiver also implements automatic hold-over capability based on a stable VCTCXO in modules and the customer's choice of reference oscillator in chip-based designs. It offers generic interfaces for external sources of synchronization (suitable for external OCXOs, IEEE1588 or Synchronous Ethernet). The receiver is optimized for stationary applications and delivers excellent GNSS sensitivity in conjunction with assistance data.

In the rest of this description the following terminology will be used:

- Disciplined oscillator: an oscillator whose frequency is corrected by a more stable frequency reference, such as a GNSS system.
- Internal oscillator: the mandatory disciplined oscillator which is used as the reference frequency for the GNSS receiver subsystem. The output from this oscillator is also available to the application as an output from the

module.

- External oscillator: an optional oscillator, disciplined by the receiver, either via I2C DAC or via UBX messages handle by a host.
- Source: a source of frequency and/or phase synchronization either measured by the receiver based on direct hardware input or an offset estimated by an external timing sub-system with respect to the receiver output. Sources are handled according to related estimates of uncertainty delivered by the application or (for oscillators) configurable models provided by the receiver.
- Holdover: periods when GNSS measurements of sufficient quality to maintain time/frequency are not available.

In all FTS related messages the above sources are indexed as follows:

Synchronization source indexing

Source	Index
Internal oscillator	0
GNSS	1
EXTINT0 (external input)	2
EXTINT1 (external input)	3
Internal oscillator measured by the host	4
External oscillator measured by the host	5

The following table lists FTS related messages:

FTS message summary

Message	Description
UBX-CFG-SMGR	Synchronization manager configuration
UBX-CFG-ESRC	External source configuration
UBX-CFG-DOSC	Disciplined oscillator configuration
UBX-CFG-TP5	Configures the output pulse parameters
UBX-CFG-NAV5	Configures which variant of UTC is used by the receiver
UBX-MON-SMGR	SMGR monitoring message
UBX-TIM-DOSC	Message containing disciplining command for external oscillators controlled through the host
UBX-TIM-HOC	Message allowing the host to directly control the module's oscillators
UBX-TIM-TOS	Message containing information about the preceding time-pulse output by the receiver
UBX-TIM-SMEAS	Message containing measurements of phase/frequency inputs
UBX-TIM-VCOCAL	Oscillator calibration command and result report
UBX-TIM-FCHG	Information about latest frequency change to an oscillator

The remainder of this chapter describes some typical use cases, introduces the Synchronization Manager (SMGR) functionality unique to FTS products and describes the use of related messages.

25.2 Example use cases

In this section some typical use cases are described.

25.2.1 Stand-alone synchronization system

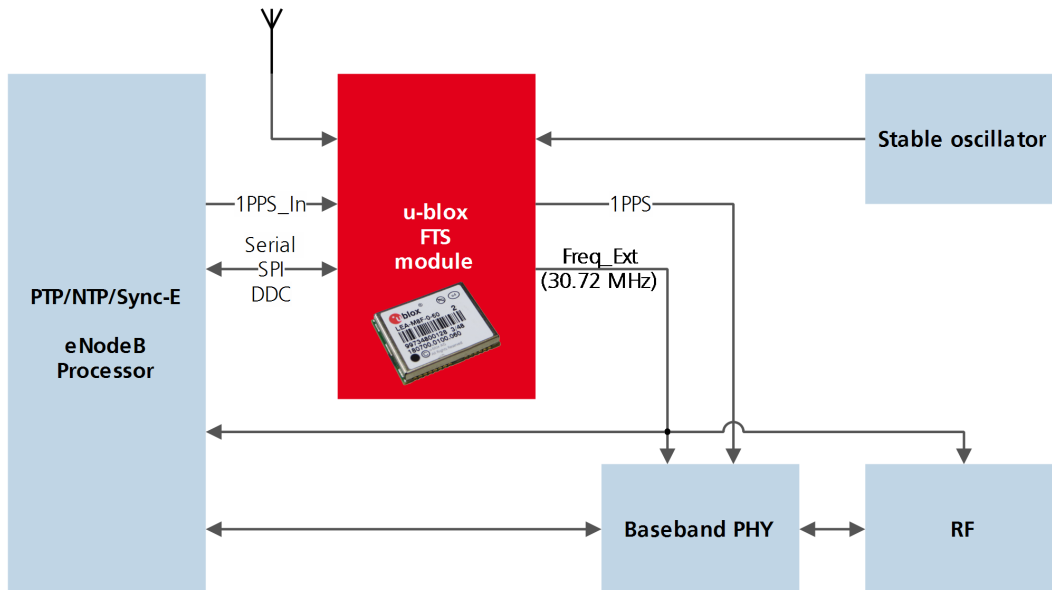

In this example, the FTS device provides a stand-alone synchronization sub-system in the context of, say, a small cell. The module's internal 30.72MHz VCTCXO is disciplined by the module and provides the frequency reference to the platform. The module provides a PPS signal to synchronize the platform's physical layer. A 1PPS (or frequency) input to the module provides frequency and/or phase information from host timing sub-systems such as PTP or Sync-E. In the absence of phase information from GNSS or any other source, the module relies on the VCTCXO for synchronization holdover, augmented by any reliable source of frequency control. In the absence of frequency control, the holdover performance is determined entirely by the VCTCXO. In some applications holdover performance will be enhanced by using an external stable (but not necessarily accurate) frequency reference.

25.2.2 Oscillator control via host

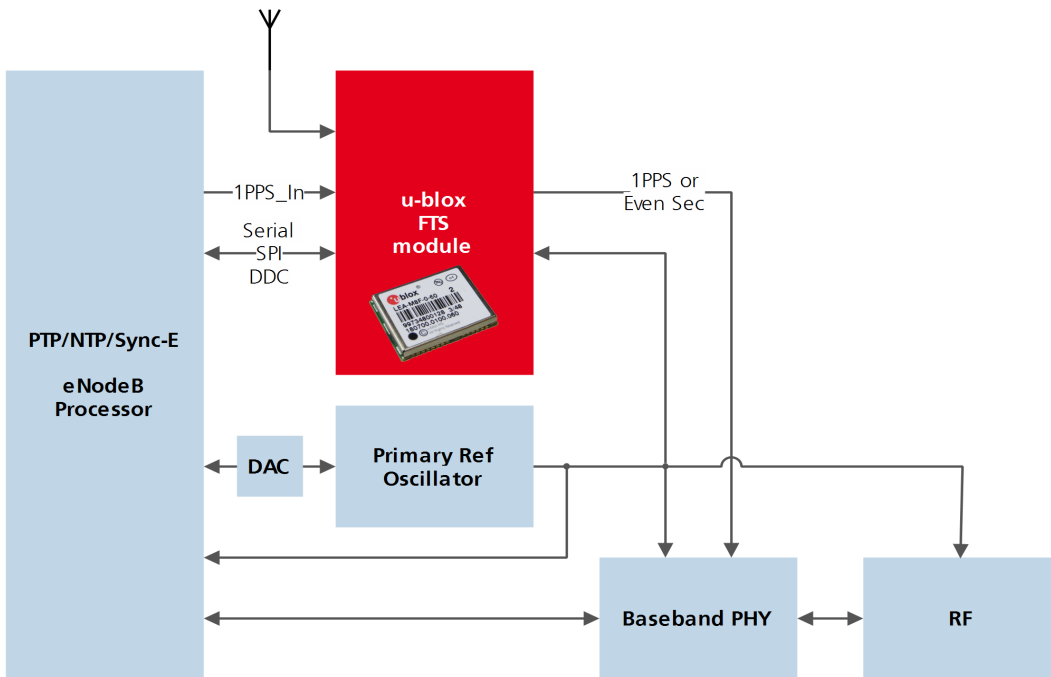

The frequency offset of the external oscillator is measured by the FTS device and communicated to the host which can then make any corrections necessary. The FTS device also generates a PPS phase reference internally (with no guarantee of coherence with the external oscillator). During holdover, the phase of 1PPS signal is maintained using either the primary reference oscillator or the 1PPS_In signal, according to their respective uncertainty.

25.2.3 Oscillator control via directly-connected DAC

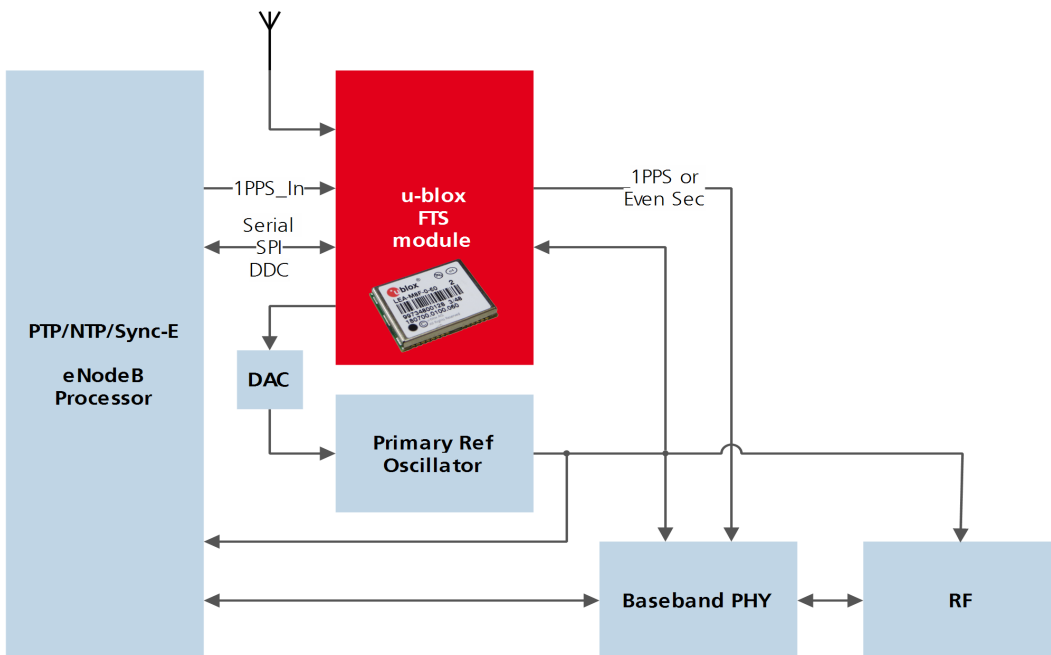

In this use case, the FTS device disciplines an external oscillator via an external DAC. During holdover the input to the external DAC is frozen and the phase of the time pulse output is maintained by the primary reference oscillator, but only guaranteed to be fully coherent with the internal oscillator. The FTS receiver can also be commanded to perform a one-off calibration of the tuning slope of external oscillator if necessary.

25.2.4 External (coherent) PPS

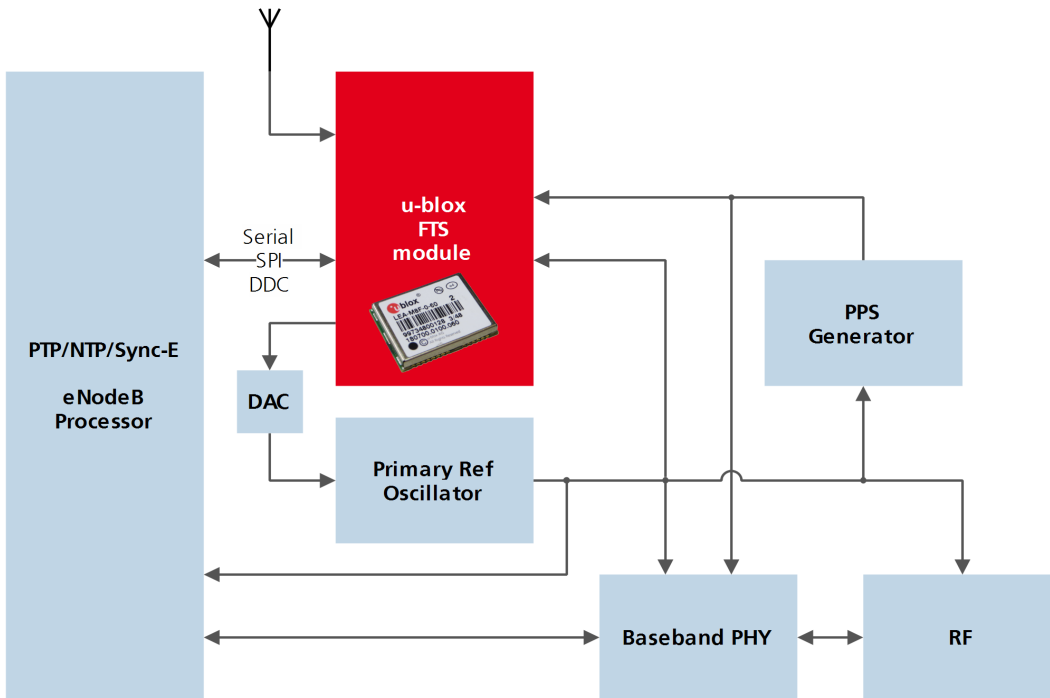

In this use case, the system PPS is generated by an external device from the output of the primary reference oscillator. The FTS receiver measures the phase of this PPS input against GNSS time or the best available source. Any small phase corrections necessary can be made by the receiver via adjustments to the oscillator frequency or directly by the host to the PPS generator (e.g. to accelerate removal of large phase errors). During holdover the DAC input is frozen.

25.3 Synchronization Manager Concept

The Synchronization Manager (SMGR) assumes the frequency and phase control functions in FTS configured devices. The SMGR uses internal and external phase and frequency measurements to derive the disciplining values (necessary frequency changes) and to assess the quality (uncertainty) of the time pulse signal and the frequency outputs. The SMGR considers the following synchronization sources:

- The GNSS solutions
- Internal oscillator
- Up to two external signals: frequency or time pulse (e.g. 1PPS) reference signals on EXTINT0 and/or EXTINT1
- Externally conducted measurements, from which the results are sent to the receiver through one of the host interfaces

Each measurement provides frequency offset and/or phase information along with an estimate of the uncertainty of each. The SMGR functional block diagram is given below:

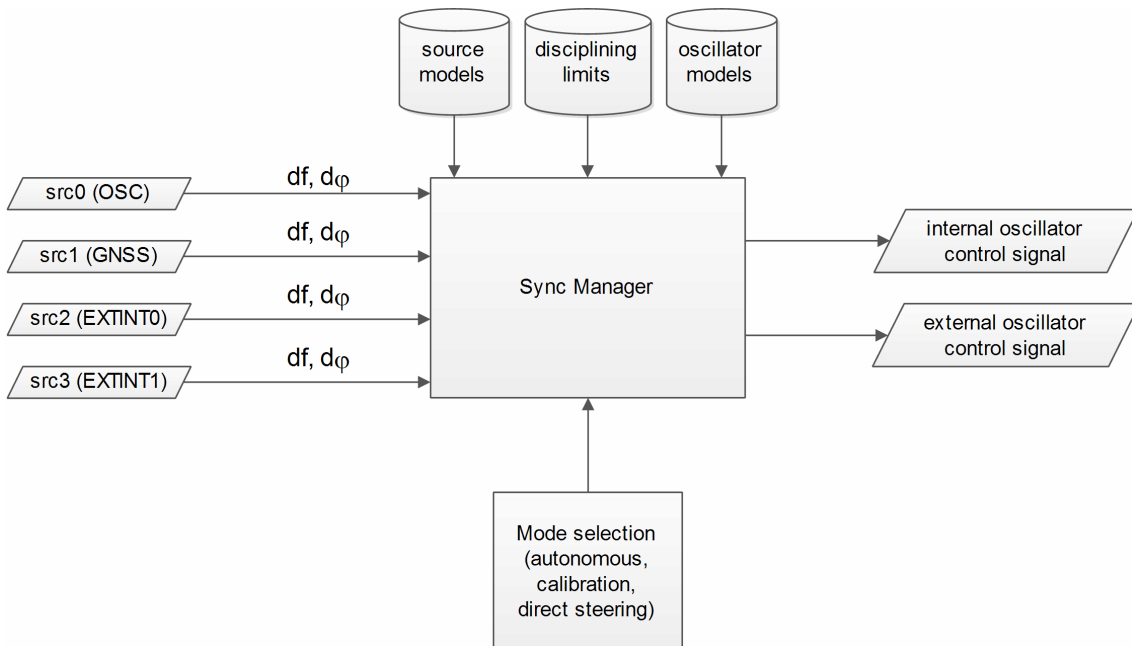

The user has the option to configure how the SMGR considers the external signals, e.g. time or frequency source, disciplined or not, etc... The user must also configure the uncertainty of the signals along with their nominal characteristics. One of the external signals may be configured as the feedback path of a disciplined external oscillator.

The SMGR can operate in frequency locked or in phase locked mode. In frequency locked mode the target of the SMGR is to eliminate frequency error. In phase locked mode the elimination of time error is the goal; this may lead to intentional deviation from the correct oscillator frequency. The correction rate in both of these modes is subject to configurable limits (see [UBX-CFG-SMGR](#)). The SMGR runs periodically (typically once a second). Its operation consists of the following stages each time it is executed:

- Choose the best source to be the reference, given the characteristics (phase noise and stability) of each of the sources and the uncertainty of their measurements.
- Calculate the phase and/or frequency errors as well as their uncertainty for each of the disciplined oscillators with respect to the reference source.
- Calculate correction for disciplined oscillators; time and/or frequency corrections are limited to the configured limits.
- Map frequency adjustment to physical output.

The SMGR runs periodically and retrieves the most recent measurements for each source along with the estimates about their respective uncertainty. The relative phase and/or frequency errors of disciplined oscillators with respect to the reference are calculated from incoming measurements and used to discipline them. The decision-making process as such does not depend on decisions made previously, however it does rely on the estimated uncertainty for each source, which is determined by comparing predicted and measured values over some moderate period of time. The SMGR only uses a single reference source at any one time. It does not combine measurements from different sources in any way. If the selected reference provides a time error measurement then a phase locked loop is possible, otherwise the receiver automatically enters frequency lock even if configured to maintain a phase lock.

In some cases the host software might choose to drive an oscillator directly. This may be useful where a large timing error has accumulated (e.g. after a long period of holdover) and normal operation would prevent the error being corrected swiftly. In this case, the host can deliberately steer the oscillator to correct timing in large

steps as configured maximum phase and frequency change limits are not applied to adjustments commanded by the host. Another use of the direct host-driven steering may be the calibration of other parts of the system. Use [UBX-TIM-HOC](#) message for this functionality.

If the time error is so large that its correction would take prohibitively long even with maximum frequency offset of the oscillator the receiver can be switched to non-coherent time pulse output mode. In this case the sync manager is temporarily reconfigured to allow time pulse intervals that are not coherent with the frequency output, i.e. there are more or less than the nominal number of cycles between two pulses. The user may optionally specify a limit on time adjustments. The output mode can be set to coherent again once the time error is sufficiently small.

A SMGR summary status is provided by [UBX-MON-SMGR](#) message.



The SMGR runs at the navigation rate set by [UBX-CFG-RATE](#). For FTS configured devices, it is not recommended to use navigation rates higher than 1Hz.

25.4 Oscillator and source specification

For correct operation, the frequency, phase and stability characteristics of all sources and disciplined oscillators must be described. External synchronization sources are configured with [UBX-CFG-ESRC](#) and disciplined oscillators with [UBX-CFG-DOSC](#). The models (short and long term stability behavior) specified by these messages provide the SMGR with the knowledge necessary to its decision making.

The user must also configure the method (coherent or non-coherent) used for frequency adjustment, the maximum frequency adjustment and other parameters contained in [UBX-CFG-DOSC](#).

It is assumed that an external voltage-controlled oscillator has a constant ratio of relative frequency change to control voltage change. The oscillator is therefore characterized by two metrics: an offset (control voltage for nominal frequency) and a gain (relative frequency change per control step). Each of these parameters are known along with their uncertainty. It is assumed that the oscillator control gain is stable over time but its offset may change significantly with aging. Because of the drift of the offset, its saved value is regularly updated in the model. The gain, on the other hand, is only updated on demand by the host application by re-configuration or calibration. For the measurement of the gain a special auto-calibration is available, described in the [calibration section](#).

External oscillator stability (frequency changes) is described by four parameters (see [UBX-CFG-DOSC](#)):

- changes with temperature: `withTemp` is the maximum deviation limit from the nominal frequency at the reference temperature over the supported temperature range (in ppb) and `timeToTemp` (in s) which is a period after which the maximum deviation limit is reached.
- aging: `maxDevLifetime` is the maximum deviation from the nominal frequency (in ppb) and `withAge` is the oscillator stability with age (in ppb/year).

25.5 Calibration

Prior to disciplining an oscillator, the SMGR must have an accurate knowledge of the controlled oscillator's frequency control gain and initial frequency offset (oscillator gains may differ significantly from unit to unit and batch to batch, largely as a result of different crystal Q). The receiver provides a slope measurement utility to aid the calibration process.

The calibration utility is a special mode where all disciplining operations are suspended and therefore all disciplined oscillators, internal or external, cease to produce usable outputs. It takes place in response to a specific request ([UBX-TIM-VCOCAL](#) message) from the host to do so for a particular oscillator and only one oscillator can be calibrated at a time. During this phase, the SMGR forces large frequency variations by changing the input of the digital to analogue conversion device whose output is driving the oscillator. Several

frequency measurements are performed and a gain is estimated.

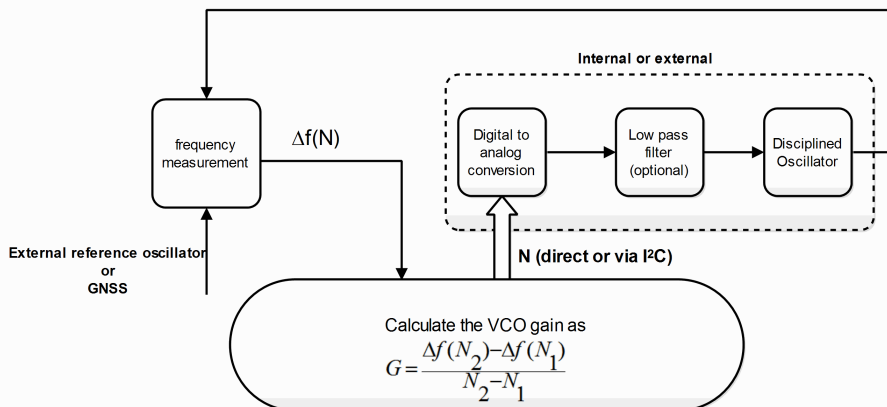

Calibration parameters must be configured or the calibration utility called before disciplining operation is possible. Once calibrated, the `calibStatus` flag in `UBX-CFG-DOSC` is set. The calibration utility can be re-triggered at any time by issuing the appropriate command through the `UBX-TIM-VCOCAL` message (not recommended during normal operation). An ongoing calibration process can be aborted using the same message with the appropriate flags. It can also be bypassed if the `calibStatus` flag in the `UBX-CFG-DOSC` message is set to 1 (oscillator is calibrated independently with results saved using the `UBX-CFG-DOSC` message).

In order to enter the calibration mode it is required that:

- A stable frequency source is available for the duration of the calibration. This source may be a GNSS solution or a frequency signal on an EXTINT pin.
- The oscillator subject to calibration is configured through the `UBX-CFG-DOSC` message (including an initial estimate of gain) and available for the duration of the process.

For an external oscillator it is also assumed that the useful range of the input is covered by the output of the DAC and that the relation frequency versus DAC input is linear. Once the calibration operation is complete the receiver will issue a UBX message to indicate that the SMGR is reverting to normal operation and to report the results of the calibration. A default for the internal oscillator is available in the firmware.

Note that it is important that only the chosen frequency source is enabled during the calibration process and that it remains stable throughout the calibration period; otherwise incorrect oscillator measurements will be made and this will lead to miscalibration and poor subsequent operation of the receiver.

25.6 FTS device Output and Top Of Second (TOS) message

The outputs available from an FTS device can be one or all of the following:

- A disciplined frequency source at the same frequency as the internal oscillator.
- A 1PPS or an even second signal (other similar rates are possible) coherent with the internal oscillator, configured by `UBX-CFG-TP5`.
- Messages reporting measurement results (for example for a host disciplined external oscillator).
- A `UBX-TIM-TOS` message which describes the current condition (accuracy, coherent or non-coherent, etc...) of the frequency and PPS outputs.
- DAC command for disciplined external oscillators.

The top of second (TOS) message is a summary of the FTS device's status. It is output shortly after each time pulse and so will normally be aligned to the second of the reference time (if available). To guarantee that this message is output as the first message after the time pulse a system of time slot reservation is provided for all

communication interfaces towards the host. For more information on this mechanism please refer to [the description of TX time slots](#)



Users of the FTS variant are expected to use the `UBX-TIM-TOS` message to obtain key parameters for each time pulse. The `UBX-TIM-TP` message is only supported for compatibility with timing receivers and is not guaranteed to provide the most appropriate information in all FTS use cases.

The time pulse of an FTS device is generated differently from that of other u-blox receivers.

FTS products support two modes of time pulse generation: "coherent" and "non-coherent" pulses.

"Coherent" pulse generation means that the number of clock cycles between two pulses is always the same.

When in "non-coherent" pulse mode the receiver may change the number of clock cycles between two pulses if it can thus reduce the phase error of the time pulse. The receiver can be configured (using `UBX-CFG-SMGR`) to operate in either of these modes or to switch from "non-coherent" to coherent mode after initial frequency and phase error has been eliminated.

It can be useful to instruct the receiver to enter the "non-coherent" pulse mode during startup or while recovering from holdover; it reduces the time necessary for phase convergence. After the phase error is reduced the host can instruct the FTS receiver to switch back to "coherent" mode again.

The `UBX-TIM-TOS` message, when enabled, indicates the actual mode of pulse generation.

Depending on the time pulse generation mode, the time pulse can be forced to be phase aligned to the oscillators. In coherent output mode the phase offset of the oscillator at the rising edge of the time pulse is defined by the `phaseOffset` field of `UBX-CFG-DOSC`. In "non-coherent" mode this constraint is ignored.



The phase offset is handled differently for both oscillators. Whereas phase lock between the internal oscillator and the time pulse is guaranteed by hardware, in the case of the external oscillator the lock is achieved by software and that lock is therefore the lock behavior is expected to be different.

The frequency, shape and offset of the time pulse can be configured with the `UBX-CFG-TP5` message. Some of the fields are interpreted differently by FTS devices compared to other u-blox receivers. Among others the `lockGnssFreq` flag is ignored and the time pulse is always aligned to the best synchronization source.

Furthermore, switching between the two time pulse frequency and length parameters is not governed by GNSS alone but by the condition selected in the `syncMode` field.



Two delay parameters can be configured using `UBX-CFG-TP5`, `antCableDelay` and `userConfigDelay`. In an FTS product care should be taken what delays are attributed to which of the delay terms. The antenna cable delay is only relevant when the receiver is following GNSS as reference; the user configurable delay is applied regardless of the active reference signal.



In current FTS products only `TIMEPULSE 2` can be used for pulse generation. Additionally, just 0.5 Hz, 1 Hz and 2 Hz time pulse output is supported by current FTS products. Other output frequencies may be configured with `UBX-CFG-TP5` but are not guaranteed to work properly.

25.7 Message transmission time slot reservations on host interfaces

The firmware provides three message transmission time slots that are aligned to the time pulse output of the receiver. No message is scheduled for transmission in the first slot after the leading edge of the time pulse. The second slot is reserved for the `UBX-TIM-TOS` message and the third slot is used for outputting other messages. However, any message transmission that was started will be finished before a new message is started.

The time slots can be enabled and configured using `UBX-CFG-TXSLOT`.



When the reference time pulse is disabled or runs at a high frequency it may happen that many or all outgoing messages are lost. Therefore the time slot mechanism should be configured to match

the time pulse behavior or disabled altogether.

This mechanism only controls when a message transmission may start and does not guarantee that the message transmission will finish before the end of the corresponding slot. Therefore the end of the last slot should be configured such that the longest enabled message can still be transmitted before the period starts when the receiver must not transmit messages.



The timing of the actual message output is also dependent on the communication interface and its clocking. On the slave interfaces (DDC and SPI) the host must provide clock in all time slots for this feature to work.

25.7.1 Example setup

Following is an example scenario. The receiver is set up to output a time pulse at a 1 Hz rate. Suppose that the following requirements are given for system integration:

- The TOS message should be output 10 to 50 ms after the time pulse.
- No other message should be output from the leading edge of the time pulse until 50 ms after the time pulse.
- The longest enabled message takes up to 100 ms to transmit through the chosen interface with the configured speed.

Then the time slots are enabled and the three slots are configured to end 10, 50 and 900 ms after the pulse respectively. The following figure indicates time pulses with upwards pointing arrows. Slot 0 (the first one active immediately after the time pulse) is active and thus blocks the transmission of new messages from 100 ms before the time pulse until 10 ms after it. Time slot 1, i.e. the time between 10 and 50 ms after the pulse, is reserved for the top-of-second message. All other messages are output in slot 2.

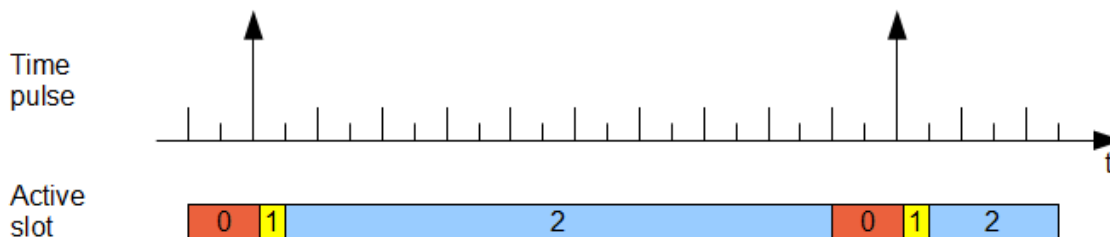

26 RTK Mode Configuration



This feature is only available with the High Precision GNSS products

u-blox RTK technology introduces the concept of a *reference station* and a *rover*. Using the RTCM3 protocol, the reference station sends corrections to the rover via a communication link enabling the rover to compute its position relative to the reference with high accuracy.



In the high precision GNSS context, the terms reference station and base station can be used interchangeably.



The distance between the reference station and the rover is called baseline length.



The reference station can provide correction to several rovers but the rover cannot concurrently process corrections from several reference stations.

The remainder of this chapter describes how to configure the reference station and the rover. More details about the RTCM3 protocol can be found in the [RTCM3](#) section.

26.1 Reference Station Mode Configuration

Reference Station Mode is a special receiver mode where the receiver uses measurements from all available satellites to broadcast corrections. Configuring a stationary reference station is done in two steps:

- The receiver must be set in *Time Mode* using the configuration steps described in the [Time Mode Configuration](#) section.
- The RTCM3 correction stream must be configured following the rules detailed in the [RTCM3 Configuration](#) section. Each RTCM message must be individually enabled using [UBX-CFG-MSG](#).



By default the reference station will begin operation in standard GNSS mode without any RTCM output. Messages for observations will be streamed as soon as they are configured for output. However messages for the reference station position will only be output when both the reference station is in fixed position mode, and the message is configured for output. As explained in the [Time Mode Configuration](#) section, this mode can be directly configured or reached at the end of a successful survey-in.



The rover will need to have received both reference station observation messages and reference station position messages in order to attempt ambiguity fixes.



When the reference station is in Time Mode, some error checking is performed on the entered, or surveyed-in, fixed position. If the result of these checks indicates that the fixed position may be incorrect, then a [UBX-INF-WARNING](#) message will be sent, with the text "Reference Station position seems incorrect".

26.2 Rover Mode Configuration

The RTK rover can be configured to work in either of these two differential modes using [UBX-CFG-DGNSS](#):

- **RTK fixed:** In this mode, the rover will attempt to fix ambiguities whenever possible.
- **RTK float:** In this mode, the rover will estimate the ambiguities as float but will make no attempts at fixing them.

The time after which old RTCM data will be discarded can be specified using the *dgnsTimeout* field in [UBX-CFG-NAV5](#).



By default the rover will begin operation in RTK fixed mode. Upon receiving an RTCM3 correction stream on any of its communication interfaces, the rover will parse the data, apply the correction and, if possible, fix ambiguities. In absence of correction data or if the correction data times out, the rover will operate in standard GNSS mode.



The time needed to resolve the ambiguity is affected by the baseline length as well as by multipath and satellite visibility at both rover and reference station.

26.3 Moving Baseline RTK Configuration

The moving baseline (MB) RTK mode differs from the standard RTK mode in that it does not require the reference to be stationary at a known location. In MB RTK mode, both the reference station and rover receivers can move while computing a centimeter-level accurate 3D vector between them. This is ideal for applications where the relative position offset between two moving vehicles is required such as, for example, the follow-me feature on a UAV.



For the sake of conciseness, in the moving baseline RTK context, the reference station and rover receivers are referred to as MB reference and MB rover, respectively.

26.3.1 MB Reference Configuration

Configuring a receiver to operate in MB reference mode is done in two steps:

- The receiver must be set in *Time Mode disabled* using the configuration message [UBX-CFG-TMODE3](#).
- The RTCM3 correction stream must be configured following the rules detailed in the [RTCM3 Configuration](#) section. Each RTCM message must be individually enabled using [UBX-CFG-MSG](#).

If the MB reference moves, then its position changes over time. To ensure that the baseline is as accurate as possible:

- The MB reference position must be sent for each epoch the MB reference observations are sent.
- The MB reference and rover must use the same navigation update rate.

26.3.2 MB Rover Configuration

As in the standard RTK mode, it is possible to configure the MB rover to operate in RTK fixed or RTK float using the [UBX-CFG-DGNSS](#) message.



By default the MB rover will begin operation in RTK fixed mode.



As discussed in the [Moving Baseline Expected Performance](#) section, RTCM corrections can only be extrapolated over a few seconds when both reference and rover receivers are moving. Therefore, any `dgnssTimeout` value configured using the [UBX-CFG-NAV5](#) message will be ignored by the MB rover.

26.3.3 Expected Performance

While the MB RTK solution aims at estimating the relative position with centimeter-level accuracy, the absolute position of each receiver is expected to be known with a standard GNSS accuracy of a few meters. Additionally, the performance of the MB RTK solution is limited by the following:

- A moving reference receiver typically experiences worse GNSS tracking than a static reference receiver in an open-sky environment and therefore the MB RTK performance may be degraded.
- The MB rover can only compute an optimal MB RTK solution if the time-matched RTCM observation and position messages are received within a predefined time limit. The MB rover will wait up to **700 ms** for messages before falling back to an extrapolated MB RTK solution. The MB rover will extrapolate the MB reference observations and/or position for up to **3 s** before falling back to standard GNSS operation.
- The achievable update rate of the MB RTK solution is limited by the communication link latency. As a rule of thumb, the communication link latency should be about half the desired navigation update period. If it exceeds 700 ms, the MB rover will not be able to compute an MB RTK solution, even at 1 Hz.
- Since the MB rover must wait for time-matched RTCM corrections from the MB RTK reference to compute its position, the overall latency of the MB RTK solution will be the sum of the communication link latency plus the MB RTK computation time.



When falling back to standard GNSS operation, the MB rover will automatically adjust the accuracy and status flag information contained in the messages listed in the [RTCM3 Output](#) section.



Upon recovering the RTCM correction stream, the MB rover will automatically try to revert to MB RTK operation.

27 Automotive Dead Reckoning (ADR)



This feature is only available with the ADR products.

27.1 Introduction

u-blox solutions for Automotive Dead Reckoning (ADR) allow high-accuracy positioning in places with poor or no GNSS coverage. ADR is based on Sensor Fusion Dead Reckoning (SFDR) technology, which combines GNSS measurements with those from external sensors.

ADR solutions use the messages of the [External Sensor Fusion \(ESF\) class](#).

27.2 ADR System Configuration

27.2.1 Enabling/Disabling Fusion Filter

The ADR fusion filter can be turned-off by means of the `useAdr` bit in the [UBX-CFG-NAVX5](#) configuration message. If fusion is turned-off, the receiver outputs a GNSS-only solution.

27.2.2 Recommended Configuration

For an optimum ADR navigation performance, the recommended general configuration is the following:

- **Navigation Rate:** the standard navigation solution update rate of 1 Hz (see [UBX-CFG-RATE](#) message) is recommended. The wheel tick quantization error is a limiting factor when using high frequency updates. This means that navigation rates higher than 1 Hz may result in lower position accuracies.

27.3 Operation

This section describes how the ADR receiver operates.

27.3.1 Fusion Filter Modes

The fusion filter operates in different modes which are output in the [UBX-ESF-STATUS](#) message.

More details about each fusion mode are given in the sequel.

27.3.1.1 Initialization Mode

The purpose of the initialization phase is to estimate all unknown parameters which are required for achieving fusion. The initialization phase is triggered after a receiver coldstart or a filter reset in case of fusion failure. The receiver is in initialization mode if the `fusionMode` field in the [UBX-ESF-STATUS](#) message is 0: `INITIALIZING`. In this case the required sensor calibration status (`calibStatus`) are flagged as 0: `NOT CALIBRATED` and the navigation solution output during initialization is based on GNSS solely.

Note that initialization phase requires good GNSS signal conditions as well as periods during which vehicle is stationary and moving (including turns). Once all required initialization steps are achieved, fusion mode is triggered and the calibration phase begins.

27.3.1.2 Fusion Mode

Once initialization phase is achieved, the receiver enters navigation mode. The receiver is in fusion mode if the `fusionMode` field in the [UBX-ESF-STATUS](#) message is set on 1: `FUSION`. The fusion filter then starts to compute combined GNSS/Dead-reckoning fixes (fused solutions) and to calibrate the sensors required for computing the fused navigation solution (`used` bit set). This is the case when the sensor calibration status (`calibStatus`) is flagged as 1: `CALIBRATING`. As soon as the calibration reached a status where optimal fusion

performance can be expected, the sensor calibration status is flagged as 2 / 3 : CALIBRATED.

27.3.1.3 Suspended Fusion Mode

Sensor fusion can be temporarily suspended in cases where no fused solution should/can be computed. The receiver is in the temporarily disabled fusion mode if the `fusionMode` field in the `UBX-ESF-STATUS` message is set on 2 : SUSPENDED. In this case, the receiver computes a GNSS-only solution.

Fusion is suspended if:

- One or several sensors deliver erroneous data or no data at all, the fusion is suspended during the sensor failure period. The receiver automatically recovers once the affected sensor(s) is/are back to normal operation.

27.3.1.4 Disabled Fusion Mode

Sensor fusion can be permanently switched-off in cases where recurrent fusion failures happen or user turned-off manually fusion. The receiver is in the permanently disabled fusion mode if the `fusionMode` field in the `UBX-ESF-STATUS` message is set on 3 : DISABLED. In such a case, the receiver computes a GNSS-only solution.

Fusion is permanently disabled in the following cases:

- If the fusion filter was manually turned-off by the user (`useAdr` bit in the `UBX-CFG-NAVX5` message is not set).
- If the fusion filter encountered too many errors.

27.3.2 Accelerated Initialization and Calibration Procedure

This section describes how to perform fast initialization and calibration of the ADR receiver for the purpose of evaluation.

The duration of the initialization phase mostly depends on the quality of the GNSS signals and the dynamics encountered by the vehicle. Therefore the car should be driven to an open and flat area like an empty open-sky parking area for example. The initialization and calibration drive should contain phases where the car is stopped during a few minutes (with engine turned-on), phases where the car is doing normal left and right turns and phases where speed is above 30 km/h under good GNSS reception conditions.

Once initialization is completed, the `fusionMode` field in the `UBX-ESF-STATUS` message switches to 1 : FUSION, combined GNSS/Dead-reckoning fixes (fused solutions) are output and the sensors used in the navigation filter start to get calibrated. Calibration is a continuous process running in the background and directly impacting the navigation solution quality.

Note that the calibration status (`calibStatus` in `UBX-ESF-STATUS` message) of some used sensors might fall back to 1 : CALIBRATING if the receiver is operated in challenging conditions. In such a case, fused navigation solution uncertainty increases until optimal conditions are observed again for re-calibrating the sensors.

27.3.3 Navigation Output

27.3.3.1 Local-level North-East-Down (NED) Frame

The local-level frame is a geodetic frame with following features:

- The origin (O) is a point on the Earth surface;
- The x-axis points to North;
- the y-axis points to East;

- the z-axis completes the right-handed reference system by pointing down.

The frame is referred to as North-East-Down (NED) since its axes are aligned with the North, East and Down directions.

27.3.3.2 Vehicle-Frame

The vehicle-frame is a right-handed 3D Cartesian frame rigidly connected with the vehicle and is used to determine the attitude of the vehicle with respect to the local-level frame. It has the following features:

- The origin (O) is the [VRP](#);
- The x-axis points towards the front of the vehicle;
- the y-axis points towards the right of the vehicle;
- the z-axis completes the right-handed reference system by pointing down.

27.3.3.3 Vehicle Position and Velocity Output

The position and velocity information is output in several messages like [UBX-NAV-PVT](#) for example. The position computed by the ADR navigation filter is referenced to the [VRP](#).

27.3.3.4 Vehicle Attitude Output

(Only supported in [protocol versions 19+](#)).

The transformation between the [vehicle-frame](#) and the [local-level frame](#) is described by three attitude angles about the local-level axes denoted as *vehicle roll*, *vehicle pitch* and *vehicle heading*. All three angles are referred as *vehicle attitude* and are illustrated in the figure below:

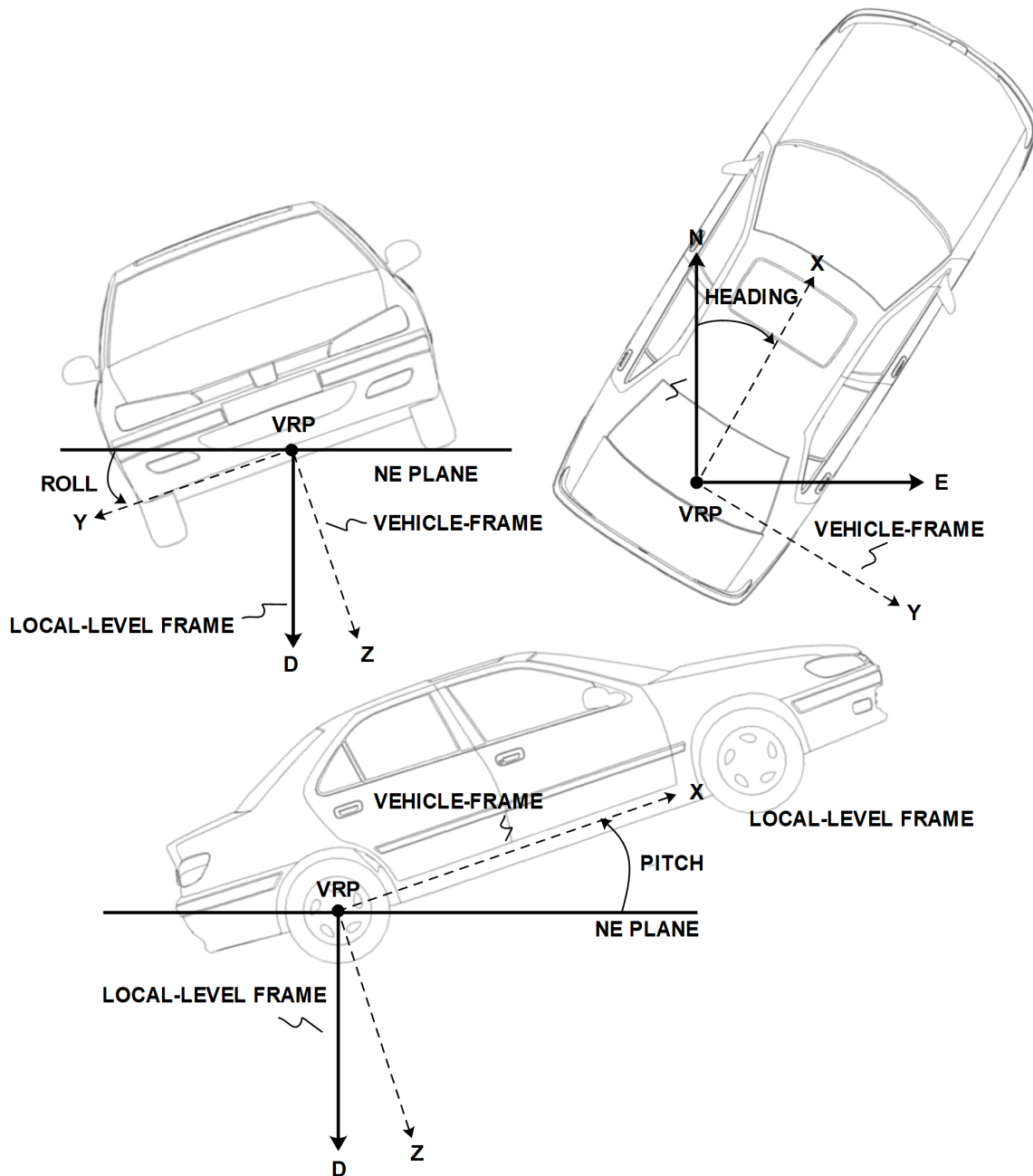

NOTES:
 N = NORTH, E = EAST, D = DOWN, IMU-FRAME ALIGNED WITH VEHICLE-FRAME

The order of the sequence of rotations around the navigation axes defining the vehicle attitude matrix in terms of vehicle attitude angles is illustrated below:

VEHICLE ATTITUDE DEFINITION

ϕ : Vehicle roll angle

θ : Vehicle pitch angle

ψ : Vehicle heading angle

C_b^n : Rotation between body-frame (b) and local-level NED navigation-frame (n)

$$C_X = \begin{bmatrix} 1 & 0 & 0 \\ 0 & \cos(\phi) & \sin(\phi) \\ 0 & -\sin(\phi) & \cos(\phi) \end{bmatrix} \quad C_Y = \begin{bmatrix} \cos(\theta) & 0 & -\sin(\theta) \\ 0 & 1 & 0 \\ \sin(\theta) & 0 & \cos(\theta) \end{bmatrix} \quad C_Z = \begin{bmatrix} \cos(\psi) & \sin(\psi) & 0 \\ -\sin(\psi) & \cos(\psi) & 0 \\ 0 & 0 & 1 \end{bmatrix}$$

$$C_b^n = C_Z^T \cdot C_Y^T \cdot C_X^T$$

$$= \begin{bmatrix} \cos(\theta) \cos(\psi) & \sin(\phi) \sin(\theta) \cos(\psi) - \cos(\phi) \sin(\psi) & \cos(\phi) \sin(\theta) \cos(\psi) + \sin(\phi) \sin(\psi) \\ \cos(\theta) \sin(\psi) & \sin(\phi) \sin(\theta) \sin(\psi) + \cos(\phi) \cos(\psi) & \cos(\phi) \sin(\theta) \sin(\psi) - \sin(\phi) \cos(\psi) \\ -\sin(\theta) & \sin(\phi) \cos(\theta) & \cos(\phi) \cos(\theta) \end{bmatrix}$$

Note that in this picture the body-frame corresponds to the [vehicle-frame](#).

The vehicle attitude is output in the [UBX-NAV-ATT](#) message. The message provides all three angles together with their accuracy estimates.



ADR products do not compute a roll angle.

27.3.3.5 Vehicle Dynamics Output

(Only supported in [protocol versions 19+](#)).

The [UBX-ESF-INS](#) message outputs information about vehicle dynamics provided by the INS: compensated vehicle angular rates and compensated vehicle accelerations. The acceleration data is free of any gravitational acceleration. It's accuracy is directly dependent on the filter attitude estimation accuracy.

Compensated vehicle dynamics information is output with respect to the [vehicle-frame](#).



The message outputs only dynamics information that is directly compensated by the fusion filter. This implies that depending on the solution type and the sensor availability, dynamics along some axes of the [vehicle-frame](#) might not be available.

27.3.4 Sensor Data Types

The supported sensor data types are:

Definition of Data Types

Type	Description	Unit	Format of the 24 data bits
0	none, data field contains no data		
1..4	reserved		
5	z-axis gyroscope angular rate	deg/s * 2 ⁻¹²	signed
6	front-left wheel ticks		Bits 0-22: unsigned tick value. Bit 23: direction indicator (0=forward, 1=backward)

Definition of Data Types continued

Type	Description	Unit	Format of the 24 data bits
7	front-right wheel ticks		Bits 0-22: unsigned tick value. Bit 23: direction indicator (0=forward, 1=backward)
8	rear-left wheel ticks		Bits 0-22: unsigned tick value. Bit 23: direction indicator (0=forward, 1=backward)
9	rear-right wheel ticks		Bits 0-22: unsigned tick value. Bit 23: direction indicator (0=forward, 1=backward)
10	single tick (speed tick)		Bits 0-22: unsigned tick value. Bit 23: direction indicator (0=forward, 1=backward)
11	speed	m/s * 1e-3	signed
12	gyroscope temperature	deg Celsius * 1e-2	signed
13	y-axis gyroscope angular rate	deg/s * 2 ⁻¹²	signed
14	x-axis gyroscope angular rate	deg/s * 2 ⁻¹²	signed
16	x-axis accelerometer specific force	m/s ² * 2 ⁻¹⁰	signed
17	y-axis accelerometer specific force	m/s ² * 2 ⁻¹⁰	signed
18	z-axis accelerometer specific force	m/s ² * 2 ⁻¹⁰	signed

27.3.5 Raw Sensor Data Output

(This feature is not supported in [protocol versions less than 15.01](#)).

Some u-blox module products contain inertial sensors (IMU) that are directly connected to the GNSS and cannot be directly accessed from outside the module. The [UBX-ESF-RAW](#) message can be used to access raw measurements of these sensors. A variable number of data fields may be used in a single message and these can contain different types of measurements. The type of each measurement is specified in the `dataType` field. The possible data types are x, y and z-axis measurements on gyroscope or accelerometer and gyroscope temperature measurements as described in the [ESF Measurement Data](#) section. One [UBX-ESF-RAW](#) message can contain multiple samples from the same sensor. The user can separate and order these using the time tags attached to each of the measurements.

The measurements are made at a fixed rate. The sampling rate or other sensor configuration options can not be changed.

To turn on this feature the [UBX-ESF-RAW](#) message must be enabled using [UBX-CFG-MSG](#). If non-zero rate is selected the message will be output but the selected rate does not otherwise have an influence at the rate of the messages.



Turning on this feature does not disable sensor fusion in the receiver. To use an external fusion algorithm consider disabling the automotive dead reckoning mode using [UBX-CFG-NAVX5](#).

27.3.6 Receiver Startup and Shutdown

Continuous dead reckoning is possible over receiver restarts if the following conditions are true:

- The vehicle is not moved while the receiver is off

During periods of external sensor data unavailability the receiver switches to GNSS-only navigation if the last sensor information indicated the vehicle was moving.

28 Untethered Dead Reckoning (UDR)



This feature is only available with the UDR products.

28.1 Introduction

u-blox solution for Untethered Dead Reckoning (UDR) allows improved navigation performance in places with GNSS-denied conditions as well as during short GNSS outages. UDR is based on Sensor Fusion Dead Reckoning (SFDR) technology, which integrates an Inertial Navigation System (INS) with GNSS measurements. The INS integrates angular rates and specific forces sensed by an Inertial Measurement Unit (IMU). The INS computes position, velocity and attitude changes and can, once initialized, provide accurate navigation information. However, an inertial-only navigation solution would degrade quickly with time due to the errors corrupting the IMU observations. The integration of the INS with GNSS measurements bounds these time-growing errors by calibrating the INS. The resulting integrated INS/GNSS filter, called *fusion filter* below, has the following advantages compared to standalone GNSS positioning:

- Improved navigation performance in GNSS-denied conditions: errors caused by multipath or weak signal conditions are mitigated through the aid brought by the IMU.
- Navigation solution during short GNSS-outages: the INS bridges short GNSS gaps which might be caused by tunnels or parking garages.

UDR solution uses the messages of the [External Sensor Fusion \(ESF\)](#) class.

28.2 UDR System Configuration

(These features are not supported in [protocol versions less than 19](#)).

28.2.1 Enabling/Disabling Fusion Filter

The UDR fusion filter can be turned-off by means of the `useAdr` bit in the [UBX-CFG-NAVX5](#) configuration message. If fusion is turned-off, the receiver outputs a GNSS-only solution.

28.2.2 Recommended Configuration

For an optimum navigation performance, the recommended general configuration is the following:

- **Navigation Rate:** the standard navigation solution update rate of 1 Hz (see [UBX-CFG-RATE](#) message) is recommended.

28.3 Operation

This section describes how the UDR receiver operates.

28.3.1 Fusion Filter Modes

The fusion filter operates in different modes which are output in the [UBX-ESF-STATUS](#) message.

More details about each fusion mode are given in the sequel.

28.3.1.1 Initialization Mode

The purpose of the initialization phase is to estimate all unknown parameters which are required for achieving fusion. The initialization phase is triggered after a receiver coldstart or a filter reset in case of fusion failure. The receiver is in initialization mode if the `fusionMode` field in the `UBX-ESF-STATUS` message is 0:

`INITIALIZING`. In this case the required sensor calibration status (`calibStatus`) are flagged as 0: `NOT CALIBRATED` and the navigation solution output during initialization is based on GNSS solely.

Note that initialization phase requires good GNSS signal conditions as well as periods during which vehicle is stationary and moving (including turns). Once all required initialization steps are achieved, fusion mode is triggered and the calibration phase begins.

28.3.1.2 Fusion Mode

Once initialization phase is achieved, the receiver enters navigation mode. The receiver is in fusion mode if the `fusionMode` field in the `UBX-ESF-STATUS` message is set on 1: `FUSION`. The fusion filter then starts to compute combined GNSS/Dead-reckoning fixes (fused solutions) and to calibrate the sensors required for computing the fused navigation solution (`used` bit set). This is the case when the sensor calibration status (`calibStatus`) is flagged as 1: `CALIBRATING`. As soon as the calibration reached a status where optimal fusion performance can be expected, the sensor calibration status is flagged as 2/3: `CALIBRATED`.

28.3.1.3 Suspended Fusion Mode

Sensor fusion can be temporarily suspended in cases where no fused solution should/can be computed. The receiver is in the temporarily disabled fusion mode if the `fusionMode` field in the `UBX-ESF-STATUS` message is set on 2: `SUSPENDED`. In this case, the receiver computes a GNSS-only solution.

Fusion is suspended if:

- One or several sensors deliver erroneous data or no data at all, the fusion is suspended during the sensor failure period. The receiver automatically recovers once the affected sensor(s) is/are back to normal operation.

28.3.1.4 Disabled Fusion Mode

Sensor fusion can be permanently switched-off in cases where recurrent fusion failures happen or user turned-off manually fusion. The receiver is in the permanently disabled fusion mode if the `fusionMode` field in the `UBX-ESF-STATUS` message is set on 3: `DISABLED`. In such a case, the receiver computes a GNSS-only solution.

Fusion is permanently disabled in the following cases:

- If the fusion filter was manually turned-off by the user (`useAdr` bit in the `UBX-CFG-NAV5` message is not set).
- If the fusion filter encountered too many errors.

28.3.2 Accelerated Initialization and Calibration Procedure

This section describes how to perform fast initialization and calibration of the UDR receiver for the purpose of evaluation.

The duration of the initialization phase mostly depends on the quality of the GNSS signals and the dynamics encountered by the vehicle. Therefore the car should be driven to an open and flat area like an empty open-sky parking area for example. The initialization and calibration drive should contain phases where the car is stopped during a few minutes (with engine turned-on), phases where the car is doing normal left and right turns and phases where speed is above 30 km/h under good GNSS reception conditions.

Once initialization is completed, the `fusionMode` field in the `UBX-ESF-STATUS` message switches to `1:FUSION`, combined GNSS/Dead-reckoning fixes (fused solutions) are output and the sensors used in the navigation filter start to get calibrated. Calibration is a continuous process running in the background and improving the navigation solution quality.

Note that the calibration status (`calibStatus` in `UBX-ESF-STATUS` message) of some used sensors might fall back to `1:CALIBRATING` if the receiver is operated in challenging conditions. In such a case, fused navigation solution uncertainty increases until optimal conditions are observed again for re-calibrating the sensors.

28.3.3 Navigation Output

(Only supported in [protocol versions 19+](#)).

28.3.3.1 Local-level North-East-Down (NED) Frame

The local-level frame is a geodetic frame with following features:

- The origin (O) is a point on the Earth surface;
- The x-axis points to North;
- the y-axis points to East;
- the z-axis completes the right-handed reference system by pointing down.

The frame is referred to as North-East-Down (NED) since its axes are aligned with the North, East and Down directions.

28.3.3.2 Body-Frame

The body-frame is a right-handed 3D Cartesian frame rigidly connected with the vehicle and is used to determine the attitude of the vehicle with respect to the local-level frame. It has the following features:

- The origin (O) is the origin of the IMU instrumental frame;
- The x-axis points towards the front of the vehicle;
- the y-axis points towards the right of the vehicle;
- the z-axis completes the right-handed reference system by pointing down.

28.3.3.3 Vehicle Position and Velocity Output

The position and velocity information is output in several messages like `UBX-NAV-PVT` for example. The position computed by the UDR navigation filter is referenced to the origin (O) of the [body-frame](#).

28.3.3.4 Vehicle Attitude Output

The transformation between the [body-frame](#) and the [local-level frame](#) is described by three attitude angles about the local-level axes denoted as *vehicle roll*, *vehicle pitch* and *vehicle heading*. All three angles are referred as *vehicle attitude* and are illustrated in the figure below:

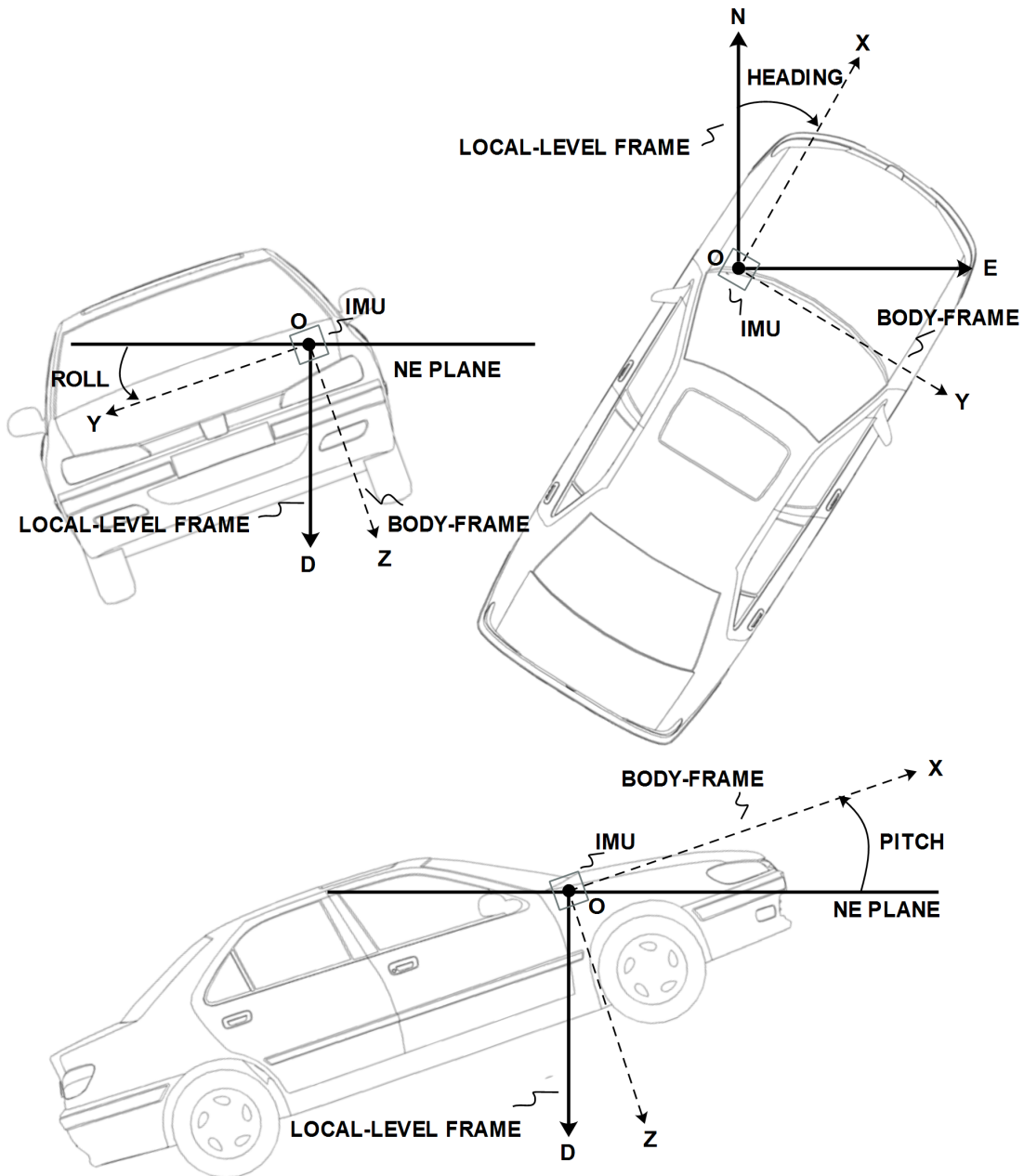

NOTES:

N = NORTH, E = EAST, D = DOWN, IMU-FRAME ALIGNED WITH BODY-FRAME

The order of the sequence of rotations around the navigation axes defining the vehicle attitude matrix in terms of vehicle attitude angles is illustrated below:

VEHICLE ATTITUDE DEFINITION

ϕ : Vehicle roll angle

θ : Vehicle pitch angle

ψ : Vehicle heading angle

C_b^n : Rotation between body-frame (b) and local-level NED navigation-frame (n)

$$C_X = \begin{bmatrix} 1 & 0 & 0 \\ 0 & \cos(\phi) & \sin(\phi) \\ 0 & -\sin(\phi) & \cos(\phi) \end{bmatrix} \quad C_Y = \begin{bmatrix} \cos(\theta) & 0 & -\sin(\theta) \\ 0 & 1 & 0 \\ \sin(\theta) & 0 & \cos(\theta) \end{bmatrix} \quad C_Z = \begin{bmatrix} \cos(\psi) & \sin(\psi) & 0 \\ -\sin(\psi) & \cos(\psi) & 0 \\ 0 & 0 & 1 \end{bmatrix}$$

$$C_b^n = C_Z^T \cdot C_Y^T \cdot C_X^T$$

$$= \begin{bmatrix} \cos(\theta) \cos(\psi) & \sin(\phi) \sin(\theta) \cos(\psi) - \cos(\phi) \sin(\psi) & \cos(\phi) \sin(\theta) \cos(\psi) + \sin(\phi) \sin(\psi) \\ \cos(\theta) \sin(\psi) & \sin(\phi) \sin(\theta) \sin(\psi) + \cos(\phi) \cos(\psi) & \cos(\phi) \sin(\theta) \sin(\psi) - \sin(\phi) \cos(\psi) \\ -\sin(\theta) & \sin(\phi) \cos(\theta) & \cos(\phi) \cos(\theta) \end{bmatrix}$$

The vehicle attitude is output in the [UBX-NAV-ATT](#) message. The message provides all three angles together with their accuracy estimates. Note that since no backwards motion information is measured, no heading of motion information is output in the [UBX-NAV-PVT](#) message (heading of vehicle is provided in a separate field within the same message).

28.3.3.5 Vehicle Dynamics Output

The [UBX-ESF-INS](#) message outputs information about vehicle dynamics provided by the INS: compensated vehicle angular rates and compensated vehicle accelerations. The acceleration data is free of any gravitational acceleration. It's accuracy is directly dependent on the filter attitude estimation accuracy.

Compensated vehicle dynamics information is output with respect to the [body-frame](#).

28.3.4 Sensor Data Types

The supported sensor data types are:

Definition of Data Types

Type	Description	Unit	Format of the 24 data bits
0	none, data field contains no data		
1..4	reserved		
5	z-axis gyroscope angular rate	deg/s * 2 ⁻¹²	signed
6	front-left wheel ticks		Bits 0-22: unsigned tick value. Bit 23: direction indicator (0=forward, 1=backward)
7	front-right wheel ticks		Bits 0-22: unsigned tick value. Bit 23: direction indicator (0=forward, 1=backward)

Definition of Data Types continued

Type	Description	Unit	Format of the 24 data bits
8	rear-left wheel ticks		Bits 0-22: unsigned tick value. Bit 23: direction indicator (0=forward, 1=backward)
9	rear-right wheel ticks		Bits 0-22: unsigned tick value. Bit 23: direction indicator (0=forward, 1=backward)
10	single tick (speed tick)		Bits 0-22: unsigned tick value. Bit 23: direction indicator (0=forward, 1=backward)
11	speed	m/s * 1e-3	signed
12	gyroscope temperature	deg Celsius * 1e-2	signed
13	y-axis gyroscope angular rate	deg/s * 2 ⁻¹²	signed
14	x-axis gyroscope angular rate	deg/s * 2 ⁻¹²	signed
16	x-axis accelerometer specific force	m/s ² * 2 ⁻¹⁰	signed
17	y-axis accelerometer specific force	m/s ² * 2 ⁻¹⁰	signed
18	z-axis accelerometer specific force	m/s ² * 2 ⁻¹⁰	signed

28.3.5 Raw Sensor Data Output

(This feature is not supported in [protocol versions less than 15.01](#)).

Some u-blox module products contain inertial sensors (IMU) that are directly connected to the GNSS and cannot be directly accessed from outside the module. The [UBX-ESF-RAW](#) message can be used to access raw measurements of these sensors. A variable number of data fields may be used in a single message and these can contain different types of measurements. The type of each measurement is specified in the `dataType` field. The possible data types are x, y and z-axis measurements on gyroscope or accelerometer and gyroscope temperature measurements as described in the [ESF Measurement Data](#) section. One [UBX-ESF-RAW](#) message can contain multiple samples from the same sensor. The user can separate and order these using the time tags attached to each of the measurements.

The measurements are made at a fixed rate. The sampling rate or other sensor configuration options can not be changed.

To turn on this feature the [UBX-ESF-RAW](#) message must be enabled using [UBX-CFG-MSG](#). If non-zero rate is selected the message will be output but the selected rate does not otherwise have an influence at the rate of the messages.



Turning on this feature does not disable sensor fusion in the receiver. To use an external fusion algorithm consider disabling the automotive dead reckoning mode using [UBX-CFG-NAVX5](#).

28.3.6 Receiver Startup and Shutdown

Continuous dead reckoning is possible over receiver restarts if the following conditions are true:

- The vehicle is not moved while the receiver is off

During periods of external sensor data unavailability the receiver switches to GNSS-only navigation if the last sensor information indicated the vehicle was moving.

29 High Navigation Rate (HNR)



This feature is only available with the [ADR](#) products.



This feature is only available with the [UDR](#) products.

29.1 Introduction

u-blox DR solutions allow a low latency position and velocity to be output at up to 30 Hz. The maximum GNSS rate is 2 Hz. Sensors measurements are used to propagate the solution at the higher rate between GNSS epochs.

The high navigation rate solution is output using the [UBX-HNR-PVT](#) message for firmwares using [protocol version 19+](#).

29.2 Configuration

The high navigation rate output can be configured using the [UBX-CFG-HNR](#) message.



If a high navigation rate has been configured with [UBX-CFG-HNR](#) then the number of enabled output messages must be adjusted to keep within the maximum throughput of the interface used.

Protocol Specification

30 NMEA Protocol

30.1 Protocol Overview

30.1.1 Message Format

NMEA messages sent by the GNSS receiver are based on NMEA 0183 Version 4.0. The following picture shows the structure of a NMEA protocol message.

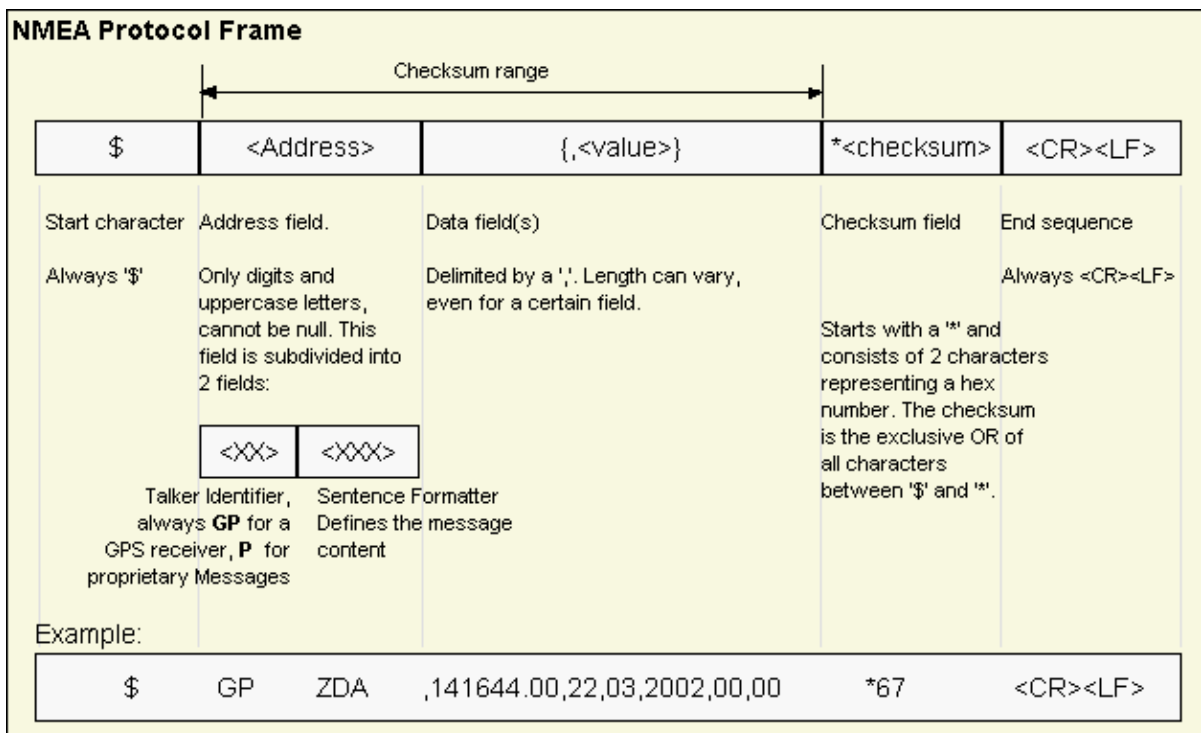

For further information on the NMEA Standard, refer to *NMEA 0183 Standard For Interfacing Marine Electronic Devices*, Version 4.00, November 1, 2008. See <http://www.nmea.org/> for ordering instructions.

The NMEA standard allows for proprietary, manufacturer-specific messages to be added. These shall be marked with a manufacturer mnemonic. The mnemonic assigned to u-blox is **UBX** and is used for all non-standard messages. These proprietary NMEA messages therefore have the address field set to **PUBX**. The first data field in a **PUBX** message identifies the message number with two digits.

30.1.2 Talker ID

One of the ways the NMEA standard differentiates between GNSS is by using a two-letter message identifier, the 'Talker ID'. The specific Talker ID used by a u-blox receiver will depend on the device model and system configuration. The table below shows the Talker ID that will be used for various GNSS configurations.

NMEA Talker IDs

Configured GNSS	Talker ID
GPS, SBAS, QZSS	GP
GLONASS	GL
Galileo	GA

NMEA Talker IDs continued

Configured GNSS	Talker ID
BeiDou	GB
Any combination of GNSS	GN

30.1.3 Protocol Configuration

The [NMEA protocol](#) on u-blox receivers can be configured to the need of customer applications using [CFG-NMEA](#). For backwards compatibility various versions of this message are supported, however, any new users should use the version that is not marked as deprecated.

There are four NMEA standards supported. The default NMEA version is 4.0. Alternatively versions 4.1, 2.3, and 2.1 can be enabled (for details on how this affects the output refer to section [Position Fix Flags in NMEA Mode](#)).



Customers using BeiDou and/or Galileo are recommended to select NMEA version 4.1, as earlier versions have no support for these two GNSS.



Customers using High Precision GNSS (HPG) products are recommended to select NMEA version 4.1, as earlier versions do not support the Float RTK (F) and Real Time Kinematic (R) mode indicator flags in all messages.

NMEA defines satellite numbering systems for some, but not all GNSS (this is partly dependent on the NMEA version). Satellite numbers for unsupported GNSS can be configured using [CFG-NMEA](#). Unknown satellite numbers are always reported as a null NMEA field (i.e. an empty string)

The NMEA specification indicates that the GGA message is GPS specific. However, u-blox receivers support the output of a GGA message for each of the Talker IDs.

NMEA filtering flags

Parameter	Description
Position filtering	Enable to permit positions from failed or invalid fixes to be reported (with the "V" status flag to indicate that the data is not valid).
Valid position filtering	Enable to permit positions from invalid fixes to be reported (with the "V" status flag to indicate that the data is not valid).
Time filtering	Enable to permit the receiver's best knowledge of time to be output, even though it might be wrong.
Date filtering	Enable to permit the receiver's best knowledge of date to be output, even though it might be wrong.
GPS-only filtering	Enable to restrict output to only report GPS satellites.
Track filtering	Enable to permit course over ground (COG) to be reported even when it would otherwise be frozen.

NMEA flags

Parameter	Description
Compatibility Mode	Some older NMEA applications expect the NMEA output to be formatted in a specific way, for example, they will only work if the latitude and longitude have exactly four digits behind the decimal point. u-blox receivers offer a compatibility mode to support these legacy applications.

NMEA flags continued

Parameter	Description
Consideration Mode	u-blox receivers use a sophisticated signal quality detection scheme, in order to produce the best possible position output. This algorithm considers all SV measurements, and may eventually decide to only use a subset thereof, if it improves the overall position accuracy. If Consideration mode is enabled, all satellites, which were considered for navigation, are communicated as being used for the position determination. If Consideration Mode is disabled, only those satellites which after the consideration step remained in the position output are marked as being used.
Limit82 Mode	Enabling this mode will limit the NMEA sentence length to a maximum of 82 characters.
High Precision Mode	Enabling this mode increases precision of the position output. Latitude and longitude then have seven digits after the decimal point, and altitude has three digits after the decimal point. Note: The High Precision Mode cannot be set in conjunction with either Compatibility Mode or Limit82 Mode.

Extended configuration

Option	Description
GNSS to filter	Filters satellites based on their GNSS
Satellite numbering	This field configures the display of satellites that do not have an NMEA-defined value. Note: this does not apply to satellites with an unknown ID.
Main Talker ID	By default the main Talker ID (i.e. the Talker ID used for all messages other than GSV) is determined by the GNSS assignment of the receiver's channels (see UBX-CFG-GNSS). This field enables the main Talker ID to be overridden.
GSV Talker ID	By default the Talker ID for GSV messages is GNSS specific (as defined by NMEA). This field enables the GSV Talker ID to be overridden.
BDS Talker ID	By default the Talker ID for BeiDou is 'GB'. This field enables the BeiDou Talker ID to be overridden.

Extra fields in NMEA 4.1 and above

Message	Extra fields
GBS	systemId, signalId
GNS	navStatus
GRS	systemId, signalId
GSA	systemId
GSV	signalId
RMC	navStatus

30.1.4 Satellite Numbering

The NMEA protocol (V4.0) identifies satellites with a two digit number, reserving the numbers 1 to 32 for GPS, 33-64 for SBAS and 65-96 for GLONASS. So, for example, GLONASS SV4 is reported using number 68. u-blox receivers support this method in their NMEA output when "strict" SV numbering is selected. In most cases this is the default setting, but can be checked or set using [UBX-CFG-NMEA](#).

Unfortunately there is currently no standard way of identifying satellites from any other GNSS within the NMEA protocol. In order to support QZSS within current receivers and prepare for support of other systems (e.g. Galileo) in future receivers, an "extended" SV numbering scheme can be enabled (using [UBX-CFG-NMEA](#)). This uses the NMEA-defined numbers where possible, but adds other number ranges to support other GNSS. Note however that these non-standard extensions require 3 digit numbers, which may not be supported by some

NMEA parsing software. For example QZSS satellites are reported using numbers in the range 193 to 197. See [Satellite Numbering Summary](#) for a complete list of satellite numbers.



GLONASS satellites can be tracked before they have been identified. In NMEA output, such unknown satellite numbers are always reported as a null field (i.e. an empty string).

30.1.5 Latitude and Longitude Format

According to the NMEA Standard, Latitude and Longitude are output in the format Degrees, Minutes and (Decimal) Fractions of Minutes. To convert to Degrees and Fractions of Degrees, or Degrees, Minutes, Seconds and Fractions of seconds, the 'Minutes' and 'Fractional Minutes' parts need to be converted. In other words: If the GPS Receiver reports a Latitude of 4717.112671 North and Longitude of 00833.914843 East, this is

Latitude 47 Degrees, 17.112671 Minutes

Longitude 8 Degrees, 33.914843 Minutes

or

Latitude 47 Degrees, 17 Minutes, 6.76026 Seconds

Longitude 8 Degrees, 33 Minutes, 54.89058 Seconds

or

Latitude 47.28521118 Degrees

Longitude 8.56524738 Degrees

30.1.6 Position Fix Flags

This section shows how u-blox implements the NMEA protocol and the conditions determining how flags are set.

Flags in NMEA 4.1 and above

<i>NMEA Message Field</i>	<i>GLL, RMC status</i>	<i>GGA quality</i>	<i>GLL, VTG posMode</i>	<i>RMC, GNS posMode</i>
No position fix (at power-up, after losing satellite lock)	V	0	N	N
GNSS fix, but user limits exceeded	V	0	N	N
Dead reckoning fix, but user limits exceeded	V	6	E	E
Dead reckoning fix	A	6	E	E
RTK float	A	5	D	F
RTK fixed	A	4	D	R
2D GNSS fix	A	1 / 2	A / D	A / D
3D GNSS fix	A	1 / 2	A / D	A / D
Combined GNSS/dead reckoning fix	A	1 / 2	A / D	A / D
	See below (1)	See below (2)	See below (3)	See below (3)

(1) Possible values for *status*: V = Data invalid, A = Data valid

(2) Possible values for *quality*: 0 = No fix, 1 = Autonomous GNSS fix, 2 = Differential GNSS fix, 4 = RTK fixed, 5 = RTK float, 6 = Estimated/Dead reckoning fix

(3) Possible values for *posMode*: N = No fix, E = Estimated/Dead reckoning fix, A = Autonomous GNSS fix, D = Differential GNSS fix, F = RTK float, R = RTK fixed

Flags in NMEA 2.3 and above

Flags in NMEA 2.3 and above continued

NMEA Message	GLL, RMC	GGA	GSA	GLL, VTG, RMC, GNS
Field	status	quality	navMode	posMode
NMEA Message	GLL, RMC	GGA	GSA	GLL, VTG, RMC, GNS
Field	status	quality	navMode	posMode
No position fix (at power-up, after losing satellite lock)	V	0	1	N
GNSS fix, but user limits exceeded	V	0	1	N
Dead reckoning fix, but user limits exceeded	V	6	2	E
Dead reckoning fix	A	6	2	E
2D GNSS fix	A	1 / 2	2	A / D
3D GNSS fix	A	1 / 2	3	A / D
Combined GNSS/dead reckoning fix	A	1 / 2	3	A / D
	See below (1)	See below (2)	See below (3)	See below (4)

(1) Possible values for *status*: V = Data invalid, A = Data valid

(2) Possible values for *quality*: 0 = No fix, 1 = Autonomous GNSS fix, 2 = Differential GNSS fix, 4 = RTK fixed, 5 = RTK float, 6 = Estimated/Dead reckoning fix

(3) Possible values for *navMode*: 1 = No fix, 2 = 2D fix, 3 = 3D fix

(4) Possible values for *posMode*: N = No fix, E = Estimated/Dead reckoning fix, A = Autonomous GNSS fix, D = Differential GNSS fix, F = RTK float, R = RTK fixed

Flags in NMEA 2.1 and below

The flags in NMEA 2.1 and below are the same as NMEA 2.3 and above but with the following differences:

- The *posMode* field is not output for GLL, RMC and VTG messages (each message has one field less).
- The GGA *quality* field is set to 1 (instead of 6) for both types of dead reckoning fix.

30.1.7 Multi-GNSS considerations

Many applications which process NMEA messages assume that only a single GNSS is active. However, when multiple GNSS are configured, the NMEA specification requires the output to change in the following ways:

NMEA output for Multi-GNSS

Change	Description
Main Talker ID	The main Talker ID will be 'GN' (e.g. instead of 'GP' for a GPS receiver)
GSV Talker IDs	The GSV message reports the signal strength of the visible satellites. However, the Talker ID it uses is specific to the GNSS it is reporting information for, so for a multi-GNSS receiver it will not be the same as the main Talker ID. (e.g. other messages will be using the 'GN' Talker ID but the GSV message will use GNSS-specific Talker IDs)
Multiple GSA and GRS Messages	Multiple GSA and GRS messages are output for each fix, one for each GNSS. This may confuse applications which assume they are output only once per position fix (as is the case for a single GNSS receiver).

30.1.8 Output of Invalid/Unknown Data

By default the receiver will not output invalid data. In such cases, it will output empty fields.

A valid position fix is reported as follows:

```
$GPGLL,4717.11634,N,00833.91297,E,124923.00,A,A*6E
```

An invalid position fix (but time valid) is reported as follows:

```
$GPGLL,,,,,124924.00,V,N*42
```

If Time is unknown (e.g. during a cold-start):

```
$GPGLL,,,,,V,N*64
```

Note:



An exception from the above default are dead reckoning fixes, which are also output when invalid (user limits exceeded).



Output of invalid data marked with the 'Invalid/Valid' Flags can be enabled using the UBX protocol message [CFG-NMEA](#).



Differing from the NMEA standard, u-blox reports valid dead reckoning fixes with user limits met (not exceeded) as valid (A) instead of invalid (V).

30.1.9 Messages Overview

When configuring NMEA messages using the UBX protocol message [CFG-MSG](#), the Class/Ids shown in the table shall be used.

Page	Mnemonic	Cls/ID	Description
NMEA Standard Messages		Standard Messages	
110	DTM	0xF0 0x0A	Datum Reference
111	GBQ	0xF0 0x44	Poll a standard message (if the current Talker ID is GB)
111	GBS	0xF0 0x09	GNSS Satellite Fault Detection
112	GGA	0xF0 0x00	Global positioning system fix data
114	GLL	0xF0 0x01	Latitude and longitude, with time of position fix and status
115	GLQ	0xF0 0x43	Poll a standard message (if the current Talker ID is GL)
115	GNQ	0xF0 0x42	Poll a standard message (if the current Talker ID is GN)
116	GNS	0xF0 0x0D	GNSS fix data
117	GPQ	0xF0 0x40	Poll a standard message (if the current Talker ID is GP)
117	GRS	0xF0 0x06	GNSS Range Residuals
118	GSA	0xF0 0x02	GNSS DOP and Active Satellites
119	GST	0xF0 0x07	GNSS Pseudo Range Error Statistics
120	GSV	0xF0 0x03	GNSS Satellites in View
121	RMC	0xF0 0x04	Recommended Minimum data
122	TXT	0xF0 0x41	Text Transmission
123	VLW	0xF0 0x0F	Dual ground/water distance
124	VTG	0xF0 0x05	Course over ground and Ground speed
125	ZDA	0xF0 0x08	Time and Date
NMEA PUBX Messages		Proprietary Messages	
126	CONFIG	0xF1 0x41	Set Protocols and Baudrate

NMEA Messages Overview continued

<i>Page</i>	<i>Mnemonic</i>	<i>Cls/ID</i>	<i>Description</i>
127	POSITION	0xF1 0x00	Lat/Long Position Data
128	RATE	0xF1 0x40	Set NMEA message output rate
129	SVSTATUS	0xF1 0x03	Satellite Status
130	TIME	0xF1 0x04	Time of Day and Clock Information

30.2 Standard Messages

Standard Messages: i.e. Messages as defined in the NMEA Standard.

30.2.1 DTM

30.2.1.1 Datum Reference

<i>Message</i>	DTM		
<i>Description</i>	Datum Reference		
<i>Firmware</i>	Supported on: <ul style="list-style-type: none"> • u-blox 8 / u-blox M8 from protocol version 15 up to version 23.01 		
<i>Type</i>	Output Message		
<i>Comment</i>	This message gives the difference between the current datum and the reference datum. The current datum defaults to WGS84 The reference datum cannot be changed and is always set to WGS84.		
<i>Message Info</i>	<i>ID for CFG-MSG</i>	<i>Number of fields</i>	
	0xF0 0x0A	11	

Message Structure:

```
$xxDTM,datum,subDatum,lat,NS,lon,EW,alt,refDatum*cs<CR><LF>
```

Example:

```
$GPDTM,W84,,0.0,N,0.0,E,0.0,W84*6F
```

```
$GPDTM,999,,0.08,N,0.07,E,-47.7,W84*1C
```

<i>Field No.</i>	<i>Name</i>	<i>Unit</i>	<i>Format</i>	<i>Example</i>	<i>Description</i>
0	xxDTM	-	string	\$GPDTM	DTM Message ID (xx = current Talker ID)
1	datum	-	string	W84	Local datum code: W84 = WGS84, 999 = user defined
2	subDatum	-	string	-	A null field
3	lat	min	numeric	0.08	Offset in Latitude
4	NS	-	character	S	North/South indicator
5	lon	min	numeric	0.07	Offset in Longitude
6	EW	-	character	E	East/West indicator
7	alt	m	numeric	-2.8	Offset in altitude
8	refDatum	-	string	W84	Reference datum code (always W84 = WGS 84)
9	cs	-	hexadecimal	*67	Checksum
10	<CR><LF>	-	character	-	Carriage return and line feed

30.2.2 GBQ

30.2.2.1 Poll a standard message (if the current Talker ID is GB)

Message	GBQ		
Description	Poll a standard message (if the current Talker ID is GB)		
Firmware	Supported on: <ul style="list-style-type: none"> u-blox 8 / u-blox M8 from protocol version 15 up to version 23.01 		
Type	Input Message		
Comment	Polls a standard NMEA message if the current Talker ID is GB		
Message Info	ID for CFG-MSG	Number of fields	
	0xF0 0x44	4	

Message Structure:

```
$xxGBQ,msgId*cs<CR><LF>
```

Example:

```
$EIGBQ,RMC*28
```

Field No.	Name	Unit	Format	Example	Description
0	xxGBQ	-	string	\$EIGBQ	GBQ Message ID (xx = Talker ID of the device requesting the poll)
1	msgId	-	string	RMC	Message ID of the message to be polled
2	cs	-	hexadecimal	*28	Checksum
3	<CR><LF>	-	character	-	Carriage return and line feed

30.2.3 GBS

30.2.3.1 GNSS Satellite Fault Detection

Message	GBS		
Description	GNSS Satellite Fault Detection		
Firmware	Supported on: <ul style="list-style-type: none"> u-blox 8 / u-blox M8 from protocol version 15 up to version 23.01 		
Type	Output Message		
Comment	This message outputs the results of the Receiver Autonomous Integrity Monitoring Algorithm (RAIM). <ul style="list-style-type: none"> The fields errLat, errLon and errAlt output the standard deviation of the position calculation, using all satellites which pass the RAIM test successfully. The fields errLat, errLon and errAlt are only output if the RAIM process passed successfully (i.e. no or successful edits happened). These fields are never output if 4 or fewer satellites are used for the navigation calculation (because, in such cases, integrity can not be determined by the receiver autonomously). The fields prob, bias and stdev are only output if at least one satellite failed in the RAIM test. If more than one satellites fail the RAIM test, only the information for the worst satellite is output in this message. 		
Message Info	ID for CFG-MSG	Number of fields	
	0xF0 0x09	13	

Message Structure:

```
$xxGBS,time,errLat,errLon,errAlt,svid,prob,bias,stdev,systemId,signalId*cs<CR><LF>
```

Example:

```
$GPGBS,235503.00,1.6,1.4,3.2,,,,,*40
$GPGBS,235458.00,1.4,1.3,3.1,03,, -21.4,3.8,1,0*5B
```

Field No.	Name	Unit	Format	Example	Description
0	xxGBS	-	string	\$GPGBS	GBS Message ID (xx = current Talker ID)
1	time	-	hhmmss.ss	235503.00	UTC time to which this RAIM sentence belongs, see note on UTC representation
2	errLat	m	numeric	1.6	Expected error in latitude
3	errLon	m	numeric	1.4	Expected error in longitude
4	errAlt	m	numeric	3.2	Expected error in altitude
5	svid	-	numeric	03	Satellite ID of most likely failed satellite
6	prob	-	numeric	-	Probability of missed detection, not supported (empty)
7	bias	m	numeric	-21.4	Estimate on most likely failed satellite (a priori residual)
8	stddev	m	numeric	3.8	Standard deviation of estimated bias
9	systemId	-	numeric	1	NMEA defined GNSS System ID NMEA v4.1 and above only
10	signalId	-	numeric	0	NMEA defined GNSS Signal ID (0 = All signals) NMEA v4.1 and above only
11	cs	-	hexadecimal	*5B	Checksum
12	<CR><LF>	-	character	-	Carriage return and line feed

30.2.4 GGA

30.2.4.1 Global positioning system fix data

Message	GGA		
Description	Global positioning system fix data		
Firmware	Supported on: <ul style="list-style-type: none"> u-blox 8 / u-blox M8 from protocol version 15 up to version 23.01 		
Type	Output Message		
Comment	<p>The output of this message is dependent on the currently selected datum (default: WGS84). The NMEA specification indicates that the GGA message is GPS specific. However, when the receiver is configured for multi-GNSS, the GGA message contents will be generated from the multi-GNSS solution. For multi-GNSS use, it is recommended that the NMEA-GNS message is used instead.</p> <p>Time and position, together with GPS fixing related data (number of satellites in use, and the resulting HDOP, age of differential data if in use, etc.).</p>		
Message Info	ID for CFG-MSG	Number of fields	
	0xF0 0x00	17	

Message Structure:

```
$xxGGA,time,lat,NS,long,EW,quality,numSV,HDOP,alt,M,sep,M,diffAge,diffStation*cs<CR><LF>
```

Example:

```
$GPGGA,092725.00,4717.11399,N,00833.91590,E,1,08,1.01,499.6,M,48.0,M,,*5B
```

GGA continued

Field No.	Name	Unit	Format	Example	Description
0	xxGGA	-	string	\$GPGGA	GGA Message ID (xx = current Talker ID)
1	time	-	hhmmss.ss	092725.00	UTC time, see note on UTC representation
2	lat	-	ddmm. mmmm	4717.11399	Latitude (degrees & minutes), see format description
3	NS	-	character	N	North/South indicator
4	long	-	dddmm. mmmm	00833.91590	Longitude (degrees & minutes), see format description
5	EW	-	character	E	East/West indicator
6	quality	-	digit	1	Quality indicator for position fix, see table below and position fix flags description
7	numSV	-	numeric	08	Number of satellites used (range: 0-12)
8	HDOP	-	numeric	1.01	Horizontal Dilution of Precision
9	alt	m	numeric	499.6	Altitude above mean sea level
10	uAlt	-	character	M	Altitude units: meters (fixed field)
11	sep	m	numeric	48.0	Geoid separation: difference between ellipsoid and mean sea level
12	uSep	-	character	M	Separation units: meters (fixed field)
13	diffAge	s	numeric	-	Age of differential corrections (blank when DGPS is not used)
14	diffStation	-	numeric	-	ID of station providing differential corrections (blank when DGPS is not used)
15	cs	-	hexadecimal	*5B	Checksum
16	<CR><LF>	-	character	-	Carriage return and line feed

Table Quality Indicator

Quality Indicator	Description, see also position fix flags description
0	No Fix / Invalid
1	Standard GPS (2D/3D)
2	Differential GPS
4	RTK fixed solution
5	RTK float solution
6	Estimated (DR) Fix

30.2.5 GLL

30.2.5.1 Latitude and longitude, with time of position fix and status

Message	GLL		
Description	Latitude and longitude, with time of position fix and status		
Firmware	Supported on: <ul style="list-style-type: none"> u-blox 8 / u-blox M8 from protocol version 15 up to version 23.01 		
Type	Output Message		
Comment	The output of this message is dependent on the currently selected datum (default: WGS84) -		
Message Info	ID for CFG-MSG	Number of fields	
	0xF0 0x01	10	

Message Structure:

```
$xxGLL, lat, NS, long, EW, time, status, posMode*cs<CR><LF>
```

Example:

```
$GPGLL, 4717.11364, N, 00833.91565, E, 092321.00, A, A*60
```

Field No.	Name	Unit	Format	Example	Description
0	xxGLL	-	string	\$GPGLL	GLL Message ID (xx = current Talker ID)
1	lat	-	ddmm. mmmm	4717.11364	Latitude (degrees & minutes), see format description
2	NS	-	character	N	North/South indicator
3	long	-	dddmm. mmmm	00833.91565	Longitude (degrees & minutes), see format description
4	EW	-	character	E	East/West indicator
5	time	-	hhmmss.ss	092321.00	UTC time, see note on UTC representation
6	status	-	character	A	V = Data invalid or receiver warning, A = Data valid. See position fix flags description .
7	posMode	-	character	A	Positioning mode, see position fix flags description . NMEA v2.3 and above only
8	cs	-	hexadecimal	*60	Checksum
9	<CR><LF>	-	character	-	Carriage return and line feed

30.2.6 GLQ

30.2.6.1 Poll a standard message (if the current Talker ID is GL)

Message	GLQ		
Description	Poll a standard message (if the current Talker ID is GL)		
Firmware	Supported on: <ul style="list-style-type: none"> u-blox 8 / u-blox M8 from protocol version 15 up to version 23.01 		
Type	Input Message		
Comment	Polls a standard NMEA message if the current Talker ID is GL		
Message Info	ID for CFG-MSG	Number of fields	
	0xF0 0x43	4	

Message Structure:

```
$xxGLQ,msgId*cs<CR><LF>
```

Example:

```
$EIGLQ,RMC*3A
```

Field No.	Name	Unit	Format	Example	Description
0	xxGLQ	-	string	\$EIGLQ	GLQ Message ID (xx = Talker ID of the device requesting the poll)
1	msgId	-	string	RMC	Message ID of the message to be polled
2	cs	-	hexadecimal	*3A	Checksum
3	<CR><LF>	-	character	-	Carriage return and line feed

30.2.7 GNQ

30.2.7.1 Poll a standard message (if the current Talker ID is GN)

Message	GNQ		
Description	Poll a standard message (if the current Talker ID is GN)		
Firmware	Supported on: <ul style="list-style-type: none"> u-blox 8 / u-blox M8 from protocol version 15 up to version 23.01 		
Type	Input Message		
Comment	Polls a standard NMEA message if the current Talker ID is GN		
Message Info	ID for CFG-MSG	Number of fields	
	0xF0 0x42	4	

Message Structure:

```
$xxGNQ,msgId*cs<CR><LF>
```

Example:

```
$EIGNQ,RMC*3A
```

Field No.	Name	Unit	Format	Example	Description
0	xxGNQ	-	string	\$EIGNQ	GNQ Message ID (xx = Talker ID of the device requesting the poll)
1	msgId	-	string	RMC	Message ID of the message to be polled
2	cs	-	hexadecimal	*3A	Checksum
3	<CR><LF>	-	character	-	Carriage return and line feed

30.2.8 GNS

30.2.8.1 GNSS fix data

Message	GNS		
Description	GNSS fix data		
Firmware	Supported on: <ul style="list-style-type: none"> u-blox 8 / u-blox M8 from protocol version 15 up to version 23.01 		
Type	Output Message		
Comment	The output of this message is dependent on the currently selected datum (default: WGS84) Time and position, together with GNSS fixing related data (number of satellites in use, and the resulting HDOP, age of differential data if in use, etc.).		
Message Info	ID for CFG-MSG	Number of fields	
	0xF0 0x0D	16	

Message Structure:

```
$xxGNS,time,lat,NS,long,EW,posMode,numSV,HDOP,alt,altRef,diffAge,diffStation,navStatus*cs<CR><LF>
```

Example:

```
$GPGNS,091547.00,5114.50897,N,00012.28663,W,AA,10,0.83,111.1,45.6,,V*71
```

Field No.	Name	Unit	Format	Example	Description
0	xxGNS	-	string	\$GPGNS	GNS Message ID (xx = current Talker ID)
1	time	-	hhmmss.ss	091547.00	UTC time, see note on UTC representation
2	lat	-	ddmm. mmmm	5114.50897	Latitude (degrees & minutes), see format description
3	NS	-	character	N	North/South indicator
4	long	-	dddmm. mmmm	00012.28663	Longitude (degrees & minutes), see format description
5	EW	-	character	E	East/West indicator
6	posMode	-	character	AA	Positioning mode, see position fix flags description . First character for GPS, second character for GLONASS
7	numSV	-	numeric	10	Number of satellites used (range: 0-99)
8	HDOP	-	numeric	0.83	Horizontal Dilution of Precision
9	alt	m	numeric	111.1	Altitude above mean sea level
10	sep	m	numeric	45.6	Geoid separation: difference between ellipsoid and mean sea level
11	diffAge	s	numeric	-	Age of differential corrections (blank when DGPS is not used)
12	diffStation	-	numeric	-	ID of station providing differential corrections (blank when DGPS is not used)
13	navStatus	-	character	V	Navigational status indicator (V = Equipment is not providing navigational status information) NMEA v4.1 and above only
14	cs	-	hexadecimal	*71	Checksum
15	<CR><LF>	-	character	-	Carriage return and line feed

30.2.9 GPQ

30.2.9.1 Poll a standard message (if the current Talker ID is GP)

Message	GPQ		
Description	Poll a standard message (if the current Talker ID is GP)		
Firmware	Supported on: <ul style="list-style-type: none"> u-blox 8 / u-blox M8 from protocol version 15 up to version 23.01 		
Type	Input Message		
Comment	Polls a standard NMEA message if the current Talker ID is GP		
Message Info	ID for CFG-MSG	Number of fields	
	0xF0 0x40	4	

Message Structure:

```
$xxGPQ,msgId*cs<CR><LF>
```

Example:

```
$EIGPQ,RMC*3A
```

Field No.	Name	Unit	Format	Example	Description
0	xxGPQ	-	string	\$EIGPQ	GPQ Message ID (xx = Talker ID of the device requesting the poll)
1	msgId	-	string	RMC	Message ID of the message to be polled
2	cs	-	hexadecimal	*3A	Checksum
3	<CR><LF>	-	character	-	Carriage return and line feed

30.2.10 GRS

30.2.10.1 GNSS Range Residuals

Message	GRS		
Description	GNSS Range Residuals		
Firmware	Supported on: <ul style="list-style-type: none"> u-blox 8 / u-blox M8 from protocol version 15 up to version 23.01 		
Type	Output Message		
Comment	<p>This messages relates to associated GGA and GSA messages.</p> <p>If less than 12 SVs are available, the remaining fields are output empty. If more than 12 SVs are used, only the residuals of the first 12 SVs are output, in order to remain consistent with the NMEA standard.</p> <p>In a multi-GNSS system this message will be output multiple times, once for each GNSS.</p>		
Message Info	ID for CFG-MSG	Number of fields	
	0xF0 0x06	19	

Message Structure:

```
$xxGRS,time, mode {,residual},systemId,signalId*cs<CR><LF>
```

Example:

```
$GPGRS,082632.00,1,0.54,0.83,1.00,1.02,-2.12,2.64,-0.71,-1.18,0.25,,1,0*70
```

Field No.	Name	Unit	Format	Example	Description
0	xxGRS	-	string	\$GPGRS	GRS Message ID (xx = current Talker ID)

GRS continued

Field No.	Name	Unit	Format	Example	Description
1	time	-	hhmmss.ss	082632.00	UTC time of associated position fix, see note on UTC representation
2	mode	-	digit	1	Mode (see table below), u-blox receivers will always output Mode 1 residuals
<i>Start of repeated block (12 times)</i>					
3 + 1*N	residual	m	numeric	0.54	Range residuals for SVs used in navigation. The SV order matches the order from the GSA sentence.
<i>End of repeated block</i>					
15	systemId	-	numeric	1	NMEA defined GNSS System ID NMEA v4.1 and above only
16	signalId	-	numeric	0	NMEA defined GNSS Signal ID (0 = All signals) NMEA v4.1 and above only
17	cs	-	hexadecimal	*70	Checksum
18	<CR><LF>	-	character	-	Carriage return and line feed

Table Mode

Mode	Description
0	Residuals were used to calculate the position given in the matching GGA sentence.
1	Residuals were recomputed after the GGA position was computed.

30.2.11 GSA

30.2.11.1 GNSS DOP and Active Satellites

Message	GSA		
Description	GNSS DOP and Active Satellites		
Firmware	Supported on: <ul style="list-style-type: none"> u-blox 8 / u-blox M8 from protocol version 15 up to version 23.01 		
Type	Output Message		
Comment	The GNSS receiver operating mode, satellites used for navigation, and DOP values. <ul style="list-style-type: none"> If less than 12 SVs are used for navigation, the remaining fields are left empty. If more than 12 SVs are used for navigation, only the IDs of the first 12 are output. The SV numbers (fields 'sv') are in the range of 1 to 32 for GPS satellites, and 33 to 64 for SBAS satellites (33 = SBAS PRN 120, 34 = SBAS PRN 121, and so on) In a multi-GNSS system this message will be output multiple times, once for each GNSS.		
Message Info	ID for CFG-MSG	Number of fields	
	0xF0 0x02	21	

Message Structure:

```
$xxGSA,opMode,navMode{,sv},PDOP,HDOP,VDOP,systemId*cs<CR><LF>
```

Example:

```
$GPGSA,A,3,23,29,07,08,09,18,26,28,,,,,1.94,1.18,1.54,1*0D
```

Field No.	Name	Unit	Format	Example	Description
0	xxGSA	-	string	\$GPGSA	GSA Message ID (xx = current Talker ID)

GSA continued

Field No.	Name	Unit	Format	Example	Description
1	opMode	-	character	A	Operation mode, see first table below
2	navMode	-	digit	3	Navigation mode, see second table below and position fix flags description
<i>Start of repeated block (12 times)</i>					
3 + 1*N	sv	-	numeric	29	Satellite number
<i>End of repeated block</i>					
15	PDOP	-	numeric	1.94	Position dilution of precision
16	HDOP	-	numeric	1.18	Horizontal dilution of precision
17	VDOP	-	numeric	1.54	Vertical dilution of precision
18	systemId	-	numeric	1	NMEA defined GNSS System ID NMEA v4.1 and above only
19	cs	-	hexadecimal	*0D	Checksum
20	<CR><LF>	-	character	-	Carriage return and line feed

Table Operation Mode

Operation Mode	Description
M	Manually set to operate in 2D or 3D mode
A	Automatically switching between 2D or 3D mode

Table Navigation Mode

Navigation Mode	Description, see also position fix flags description
1	Fix not available
2	2D Fix
3	3D Fix

30.2.12 GST

30.2.12.1 GNSS Pseudo Range Error Statistics

Message	GST		
Description	GNSS Pseudo Range Error Statistics		
Firmware	Supported on: <ul style="list-style-type: none"> u-blox 8 / u-blox M8 from protocol version 15 up to version 23.01 		
Type	Output Message		
Comment	This message reports statistical information on the quality of the position solution.		
Message Info	ID for CFG-MSG	Number of fields	
	0xF0 0x07	11	

Message Structure:

```
$xxGST,time,rangeRms,stdMajor,stdMinor,orient,stdLat,stdLong,stdAlt*cs<CR><LF>
```

Example:

```
$GPGST,082356.00,1.8,,,,,1.7,1.3,2.2*7E
```

Field No.	Name	Unit	Format	Example	Description
0	xxGST	-	string	\$GPGST	GST Message ID (xx = current Talker ID)

GST continued

Field No.	Name	Unit	Format	Example	Description
1	time	-	hhmmss.ss	082356.00	UTC time of associated position fix, see note on UTC representation
2	rangeRms	m	numeric	1.8	RMS value of the standard deviation of the ranges
3	stdMajor	m	numeric	-	Standard deviation of semi-major axis (only supported in ADR 4.10 and above)
4	stdMinor	m	numeric	-	Standard deviation of semi-minor axis (only supported in ADR 4.10 and above)
5	orient	deg	numeric	-	Orientation of semi-major axis (only supported in ADR 4.10 and above)
6	stdLat	m	numeric	1.7	Standard deviation of latitude error
7	stdLong	m	numeric	1.3	Standard deviation of longitude error
8	stdAlt	m	numeric	2.2	Standard deviation of altitude error
9	cs	-	hexadecimal	*7E	Checksum
10	<CR><LF>	-	character	-	Carriage return and line feed

30.2.13 GSV

30.2.13.1 GNSS Satellites in View

Message	GSV		
Description	GNSS Satellites in View		
Firmware	Supported on: <ul style="list-style-type: none"> u-blox 8 / u-blox M8 from protocol version 15 up to version 23.01 		
Type	Output Message		
Comment	The number of satellites in view, together with each SV ID, elevation azimuth, and signal strength (C/No) value. Only four satellite details are transmitted in one message. In a multi-GNSS system sets of GSV messages will be output multiple times, one set for each GNSS.		
Message Info	ID for CFG-MSG	Number of fields	
	0xF0 0x03	8..16	

Message Structure:

```
$xxGSV,numMsg,msgNum,numSV,{,sv,elv,az,cno},signalId*cs<CR><LF>
```

Example:

```
$GPGSV,3,1,10,23,38,230,44,29,71,156,47,07,29,116,41,08,09,081,36,0*7F
```

```
$GPGSV,3,2,10,10,07,189,,05,05,220,,09,34,274,42,18,25,309,44,0*72
```

```
$GPGSV,3,3,10,26,82,187,47,28,43,056,46,0*77
```

Field No.	Name	Unit	Format	Example	Description
0	xxGSV	-	string	\$GPGSV	GSV Message ID (xx = GSV Talker ID)
1	numMsg	-	digit	3	Number of messages, total number of GSV messages being output
2	msgNum	-	digit	1	Number of this message
3	numSV	-	numeric	10	Number of satellites in view

Start of repeated block (1..4 times)

GSV continued

Field No.	Name	Unit	Format	Example	Description
4 + 4*N	sv	-	numeric	23	Satellite ID
5 + 4*N	elv	deg	numeric	38	Elevation (range 0-90)
6 + 4*N	az	deg	numeric	230	Azimuth, (range 0-359)
7 + 4*N	cno	dBH z	numeric	44	Signal strength (C/N0, range 0-99), blank when not tracking
End of repeated block					
5.. 16	signalId	-	numeric	0	NMEA defined GNSS Signal ID (0 = All signals) NMEA v4.1 and above only
6.. 16	cs	-	hexadecimal	*7F	Checksum
7.. 16	<CR><LF>	-	character	-	Carriage return and line feed

30.2.14 RMC

30.2.14.1 Recommended Minimum data

Message	RMC		
Description	Recommended Minimum data		
Firmware	Supported on: <ul style="list-style-type: none"> u-blox 8 / u-blox M8 from protocol version 15 up to version 23.01 		
Type	Output Message		
Comment	The output of this message is dependent on the currently selected datum (default: WGS84) The recommended minimum sentence defined by NMEA for GNSS system data.		
Message Info	ID for CFG-MSG	Number of fields	
	0xF0 0x04	16	

Message Structure:

```
$xxRMC,time,status,lat,NS,long,EW,spd,cog,date,mv,mvEW,posMode,navStatus*cs<CR><LF>
```

Example:

```
$GPRMC,083559.00,A,4717.11437,N,00833.91522,E,0.004,77.52,091202,,A,V*57
```

Field No.	Name	Unit	Format	Example	Description
0	xxRMC	-	string	\$GPRMC	RMC Message ID (xx = current Talker ID)
1	time	-	hhmmss.ss	083559.00	UTC time, see note on UTC representation
2	status	-	character	A	Status, V = Navigation receiver warning, A = Data valid, see position fix flags description
3	lat	-	ddmm. mmmm	4717.11437	Latitude (degrees & minutes), see format description
4	NS	-	character	N	North/South indicator

RMC continued

Field No.	Name	Unit	Format	Example	Description
5	long	-	dddmm. mmmmm	00833.91522	Longitude (degrees & minutes), see format description
6	EW	-	character	E	East/West indicator
7	spd	knot s	numeric	0.004	Speed over ground
8	cog	degr ees	numeric	77.52	Course over ground
9	date	-	ddmmyy	091202	Date in day, month, year format, see note on UTC representation
10	mv	degr ees	numeric	-	Magnetic variation value. Only supported in ADR 4.10 and above.
11	mvEW	-	character	-	Magnetic variation E/W indicator. Only supported in ADR 4.10 and above.
12	posMode	-	character	A	Mode Indicator, see position fix flags description NMEA v2.3 and above only
13	navStatu s	-	character	V	Navigational status indicator (V = Equipment is not providing navigational status information) NMEA v4.1 and above only
14	cs	-	hexadecimal	*57	Checksum
15	<CR><LF>	-	character	-	Carriage return and line feed

30.2.15 TXT

30.2.15.1 Text Transmission

Message	TXT		
Description	Text Transmission		
Firmware	Supported on: <ul style="list-style-type: none"> • u-blox 8 / u-blox M8 from protocol version 15 up to version 23.01 		
Type	Output Message		
Comment	This message is not configured through UBX-CFG-MSG, but instead through UBX-CFG-INF. This message outputs various information on the receiver, such as power-up screen, software version etc. This message can be configured using UBX Protocol message UBX-CFG-INF .		
Message Info	ID for CFG-MSG	Number of fields	
	0xF0 0x41	7	

Message Structure:

```
$<xx>TXT, numMsg, msgNum, msgType, text *cs<CR><LF>
```

Example:

```
$GPTXT,01,01,02,u-blox ag - www.u-blox.com*50
```

```
$GPTXT,01,01,02,ANTARIS ATR0620 HW 00000040*67
```

Field No.	Name	Unit	Format	Example	Description
-----------	------	------	--------	---------	-------------

TXT continued

Field No.	Name	Unit	Format	Example	Description
0	xxTXT	-	string	\$GPTXT	TXT Message ID (xx = current Talker ID)
1	numMsg	-	numeric	01	Total number of messages in this transmission, 01..99
2	msgNum	-	numeric	01	Message number in this transmission, range 01..xx
3	msgType	-	numeric	02	Text identifier, u-blox receivers specify the type of the message with this number. 00: Error 01: Warning 02: Notice 07: User
4	text	-	string	www.u-blox.com	Any ASCII text
5	cs	-	hexadecimal	*67	Checksum
6	<CR><LF>	-	character	-	Carriage return and line feed

30.2.16 VLW

30.2.16.1 Dual ground/water distance

Message	VLW		
Description	Dual ground/water distance		
Firmware	Supported on: <ul style="list-style-type: none"> u-blox 8 / u-blox M8 from protocol version 15 up to version 23.01 		
Type	Output Message		
Comment	The distance traveled, relative to the water and over the ground. This message relates to the Odometer functionality.		
Message Info	ID for CFG-MSG	Number of fields	
	0xF0 0x0F	11	

Message Structure:

```
$xxVLW,twd,twdUnit,wd,wdUnit,tgd,tgdUnit,gd,gdUnit*cs<CR><LF>
```

Example:

```
$GPVLW,,N,,N,15.8,N,1.2,N*06
```

Field No.	Name	Unit	Format	Example	Description
0	xxVLW	-	string	\$GPVLW	VLW Message ID (xx = current Talker ID)
1	twd	nm	numeric	-	Total cumulative water distance, not output
2	twdUnit	-	character	N	Fixed field: nautical miles
3	wd	nm	numeric	-	Water distance since reset, not output
4	wdUnit	-	character	N	Fixed field: nautical miles
5	tgd	nm	numeric	15.8	Total cumulative ground distance
6	tgdUnit	-	character	N	Fixed field: nautical miles
7	gd	nm	numeric	1.2	Ground distance since reset
8	gdUnit	-	character	N	Fixed field: nautical miles
9	cs	-	hexadecimal	*06	Checksum
10	<CR><LF>	-	character	-	Carriage return and line feed

30.2.17 VTG

30.2.17.1 Course over ground and Ground speed

Message	VTG		
Description	Course over ground and Ground speed		
Firmware	Supported on: <ul style="list-style-type: none"> u-blox 8 / u-blox M8 from protocol version 15 up to version 23.01 		
Type	Output Message		
Comment	Velocity is given as Course over Ground (COG) and Speed over Ground (SOG).		
Message Info	ID for CFG-MSG	Number of fields	
	0xF0 0x05	12	

Message Structure:

```
$xxVTG,cogt,T,cogm,M,knots,N,kph,K,posMode*cs<CR><LF>
```

Example:

```
$GPVTG,77.52,T,,M,0.004,N,0.008,K,A*06
```

Field No.	Name	Unit	Format	Example	Description
0	xxVTG	-	string	\$GPVTG	VTG Message ID (xx = current Talker ID)
1	cogt	degrees	numeric	77.52	Course over ground (true)
2	T	-	character	T	Fixed field: true
3	cogm	degrees	numeric	-	Course over ground (magnetic). Only supported in ADR 4.10 and above.
4	M	-	character	M	Fixed field: magnetic
5	knots	knots	numeric	0.004	Speed over ground
6	N	-	character	N	Fixed field: knots
7	kph	km/h	numeric	0.008	Speed over ground
8	K	-	character	K	Fixed field: kilometers per hour
9	posMode	-	character	A	Mode Indicator, see position fix flags description NMEA v2.3 and above only
10	cs	-	hexadecimal	*06	Checksum
11	<CR><LF>	-	character	-	Carriage return and line feed

30.2.18 ZDA

30.2.18.1 Time and Date

Message	ZDA		
Description	Time and Date		
Firmware	Supported on: <ul style="list-style-type: none"> u-blox 8 / u-blox M8 from protocol version 15 up to version 23.01 		
Type	Output Message		
Comment	-		
Message Info	ID for CFG-MSG	Number of fields	
	0xF0 0x08	9	

Message Structure:

```
$xxZDA,hhmmss.ss,day,month,year,ltzh,ltzn*cs<CR><LF>
```

Example:

```
$GPZDA,082710.00,16,09,2002,00,00*64
```

Field No.	Name	Unit	Format	Example	Description
0	xxZDA	-	string	\$GPZDA	ZDA Message ID (xx = current Talker ID)
1	time	-	hhmmss.ss	082710.00	UTC Time, see note on UTC representation
2	day	day	dd	16	UTC day (range: 1-31)
3	month	month	mm	09	UTC month (range: 1-12)
4	year	year	yyyy	2002	UTC year
5	ltzh	-	-xx	00	Local time zone hours (fixed to 00)
6	ltzn	-	zz	00	Local time zone minutes (fixed to 00)
7	cs	-	hexadecimal	*64	Checksum
8	<CR><LF>	-	character	-	Carriage return and line feed

30.3 PUBX Messages

Proprietary Messages: i.e. Messages defined by u-blox.

30.3.1 CONFIG (PUBX,41)

30.3.1.1 Set Protocols and Baudrate

Message	CONFIG		
Description	Set Protocols and Baudrate		
Firmware	Supported on: <ul style="list-style-type: none"> u-blox 8 / u-blox M8 from protocol version 15 up to version 23.01 		
Type	Set Message		
Comment	-		
Message Info	ID for CFG-MSG	Number of fields	
	0xF1 0x41	9	

Message Structure:

```
$PUBX,41,portId,inProto,outProto,baudrate,autobauding*cs<CR><LF>
```

Example:

```
$PUBX,41,1,0007,0003,19200,0*25
```

Field No.	Name	Unit	Format	Example	Description
0	\$PUBX	-	string	\$PUBX	Message ID, UBX protocol header, proprietary sentence
1	msgId	-	numeric	41	Proprietary message identifier
2	portId	-	numeric	1	ID of communication port. For a list of port IDs see Serial Communication Ports Description .
3	inProto	-	hexadecimal	0007	Input protocol mask. Bitmask, specifying which protocols(s) are allowed for input. For details see corresponding field in UBX-CFG-PRT .
4	outProto	-	hexadecimal	0003	Output protocol mask. Bitmask, specifying which protocols(s) are allowed for input. For details see corresponding field in UBX-CFG-PRT .
5	baudrate	bits/s	numeric	19200	Baudrate
6	autobauding	-	numeric	0	Autobauding: 1=enable, 0=disable (not supported on u-blox 5, set to 0)
7	cs	-	hexadecimal	*25	Checksum
8	<CR><LF>	-	character	-	Carriage return and line feed

30.3.2 POSITION (PUBX,00)

30.3.2.1 Lat/Long Position Data

Message	POSITION		
Description	Lat/Long Position Data		
Firmware	Supported on: <ul style="list-style-type: none"> u-blox 8 / u-blox M8 from protocol version 15 up to version 23.01 		
Type	Output Message		
Comment	The output of this message is dependent on the currently selected datum (default: WGS84) This message contains position solution data. The datum selection may be changed using the message UBX-CFG-DAT .		
Message Info	ID for CFG-MSG	Number of fields	
	0xF1 0x00	23	

Message Structure:

```
$PUBX,00,time,lat,NS,long,EW,altRef,navStat,hAcc,vAcc,SOG,COG,vVel,diffAge,HDOP,VDOP,TDOP,numSvs,rserved,DR,*cs<CR><LF>
```

Example:

```
$PUBX,00,081350.00,4717.113210,N,00833.915187,E,546.589,G3,2.1,2.0,0.007,77.52,0.007,,0.92,1.19,0.77,9,0,0*5F
```

Field No.	Name	Unit	Format	Example	Description
0	\$PUBX	-	string	\$PUBX	Message ID, UBX protocol header, proprietary sentence
1	msgId	-	numeric	00	Proprietary message identifier: 00
2	time	-	hhmmss.ss	081350.00	UTC time, see note on UTC representation
3	lat	-	ddmm. mmmm	4717.113210	Latitude (degrees & minutes), see format description
4	NS	-	character	N	North/South Indicator
5	long	-	dddmm. mmmm	00833.915187	Longitude (degrees & minutes), see format description
6	EW	-	character	E	East/West indicator
7	altRef	m	numeric	546.589	Altitude above user datum ellipsoid.
8	navStat	-	string	G3	Navigation Status, See Table below
9	hAcc	m	numeric	2.1	Horizontal accuracy estimate.
10	vAcc	m	numeric	2.0	Vertical accuracy estimate.
11	SOG	km/h	numeric	0.007	Speed over ground
12	COG	deg	numeric	77.52	Course over ground
13	vVel	m/s	numeric	0.007	Vertical velocity (positive downwards)
14	diffAge	s	numeric	-	Age of differential corrections (blank when DGPS is not used)
15	HDOP	-	numeric	0.92	HDOP, Horizontal Dilution of Precision
16	VDOP	-	numeric	1.19	VDOP, Vertical Dilution of Precision
17	TDOP	-	numeric	0.77	TDOP, Time Dilution of Precision
18	numSvs	-	numeric	9	Number of satellites used in the navigation solution

POSITION continued

Field No.	Name	Unit	Format	Example	Description
19	reserved	-	numeric	0	Reserved, always set to 0
20	DR	-	numeric	0	DR used
21	cs	-	hexadecimal	*5B	Checksum
22	<CR><LF>	-	character	-	Carriage return and line feed

Table Navigation Status

Navigation Status	Description
NF	No Fix
DR	Dead reckoning only solution
G2	Stand alone 2D solution
G3	Stand alone 3D solution
D2	Differential 2D solution
D3	Differential 3D solution
RK	Combined GPS + dead reckoning solution
TT	Time only solution

30.3.3 RATE (PUBX,40)

30.3.3.1 Set NMEA message output rate

Message	RATE		
Description	Set NMEA message output rate		
Firmware	Supported on: <ul style="list-style-type: none"> u-blox 8 / u-blox M8 from protocol version 15 up to version 23.01 		
Type	Set Message		
Comment	Set/Get message rate configuration (s) to/from the receiver. <ul style="list-style-type: none"> Send rate is relative to the event a message is registered on. For example, if the rate of a navigation message is set to 2, the message is sent every second navigation solution. 		
Message Info	ID for CFG-MSG	Number of fields	
	0xF1 0x40	11	

Message Structure:

```
$PUBX,40,msgId,rddc,rus1,rus2,rusb,rspi,reserved*cs<CR><LF>
```

Example:

```
$PUBX,40,GLL,1,0,0,0,0,0*5D
```

Field No.	Name	Unit	Format	Example	Description
0	\$PUBX	-	string	\$PUBX	Message ID, UBX protocol header, proprietary sentence
1	ID	-	numeric	40	Proprietary message identifier
2	msgId	-	string	GLL	NMEA message identifier
3	rddc	cycles	numeric	1	output rate on DDC 0 disables that message from being output on this port 1 means that this message is output every epoch

RATE continued

Field No.	Name	Unit	Format	Example	Description
4	rus1	cycles	numeric	1	output rate on USART 1 0 disables that message from being output on this port 1 means that this message is output every epoch
5	rus2	cycles	numeric	1	output rate on USART 2 0 disables that message from being output on this port 1 means that this message is output every epoch
6	rusb	cycles	numeric	1	output rate on USB 0 disables that message from being output on this port 1 means that this message is output every epoch
7	rspi	cycles	numeric	1	output rate on SPI 0 disables that message from being output on this port 1 means that this message is output every epoch
8	reserved	-	numeric	0	Reserved: always fill with 0
9	cs	-	hexadecimal	*5D	Checksum
10	<CR><LF>	-	character	-	Carriage return and line feed

30.3.4 SVSTATUS (PUBX,03)

30.3.4.1 Satellite Status

Message	SVSTATUS		
Description	Satellite Status		
Firmware	Supported on: <ul style="list-style-type: none"> u-blox 8 / u-blox M8 from protocol version 15 up to version 23.01 		
Type	Output Message		
Comment	The PUBX,03 message contains satellite status information.		
Message Info	ID for CFG-MSG	Number of fields	
	0xF1 0x03	5 + 6*n	

Message Structure:

```
$PUBX,03,GT{,sv,s,az,e1,cno,lck},*cs<CR><LF>
```

Example:

```
$PUBX,03,11,23,-,-,45,010,29,-,-,46,013,07,-,-,42,015,08,U,067,31,42,025,10,U,195,33,46,026,18,U,326,08,39,026,17,-,-,32,015,26,U,306,66,48,025,27,U,073,10,36,026,28,U,089,61,46,024,15,-,-,39,014*0D
```

Field No.	Name	Unit	Format	Example	Description
0	\$PUBX	-	string	\$PUBX	Message ID, UBX protocol header, proprietary sentence
1	msgId	-	numeric	03	Proprietary message identifier: 03
2	n	-	numeric	11	Number of GNSS satellites tracked
Start of repeated block (n times)					

SVSTATUS continued

Field No.	Name	Unit	Format	Example	Description
3 + 6*N	sv	-	numeric	23	Satellite ID according to UBX svld mapping (see section satellite numbering)
4 + 6*N	s	-	character	-	Satellite status, see table below
5 + 6*N	az	deg	numeric	-	Satellite azimuth (range: 0-359)
6 + 6*N	e1	deg	numeric	-	Satellite elevation (range: 0-90)
7 + 6*N	cno	dBHz	numeric	45	Signal strength (C/N0, range 0-99), blank when not tracking
8 + 6*N	lck	s	numeric	010	Satellite carrier lock time (range: 0-64) 0: code lock only 64: lock for 64 seconds or more
<i>End of repeated block</i>					
3 + 6*n	cs	-	hexadecimal	*0D	Checksum
4 + 6*n	<CR><LF>	-	character	-	Carriage return and line feed

Table Satellite Status

Satellite Status	Description
-	Not used
U	Used in solution
e	Ephemeris available, but not used for navigation

30.3.5 TIME (PUBX,04)

30.3.5.1 Time of Day and Clock Information

Message	TIME		
Description	Time of Day and Clock Information		
Firmware	Supported on: <ul style="list-style-type: none"> u-blox 8 / u-blox M8 from protocol version 15 up to version 23.01 		
Type	Output Message		
Comment	-		
Message Info	ID for CFG-MSG	Number of fields	
	0xF1 0x04	12	

Message Structure:

```
$PUBX,04,time,date,utcTow,utcWk,leapSec,clkBias,clkDrift,tpGran,*cs<CR><LF>
```

Example:

```
$PUBX,04,073731.00,091202,113851.00,1196,15D,1930035,-2660.664,43,*3C
```

Field No.	Name	Unit	Format	Example	Description
0	\$PUBX	-	string	\$PUBX	Message ID, UBX protocol header, proprietary sentence

TIME continued

Field No.	Name	Unit	Format	Example	Description
1	msgId	-	numeric	04	Proprietary message identifier: 04
2	time	-	hhmmss.ss	073731.00	UTC time, see note on UTC representation
3	date	-	ddmmyy	091202	UTC date, day, month, year format, see note on UTC representation
4	utcTow	s	numeric	113851.00	UTC Time of Week
5	utcWk	-	numeric	1196	UTC week number, continues beyond 1023
6	leapSec	s	numeric/text	15D	Leap seconds The number is marked with a 'D' if the value is the firmware default value. If the value is not marked it has been received from a satellite.
7	clkBias	ns	numeric	1930035	Receiver clock bias
8	clkDrift	ns/s	numeric	-2660.664	Receiver clock drift
9	tpGran	ns	numeric	43	Time Pulse Granularity, The quantization error of the TIMEPULSE pin
10	cs	-	hexadecimal	*3C	Checksum
11	<CR><LF>	-	character	-	Carriage Return and Line Feed

31 UBX Protocol

31.1 UBX Protocol Key Features

u-blox receivers support a u-blox proprietary protocol to communicate with a host computer. This protocol has the following key features:

- Compact - uses 8 Bit Binary Data.
- Checksum Protected - uses a low-overhead checksum algorithm
- Modular - uses a 2-stage message identifier (Class and Message ID)

31.2 UBX Packet Structure

A basic UBX Packet looks as follows:

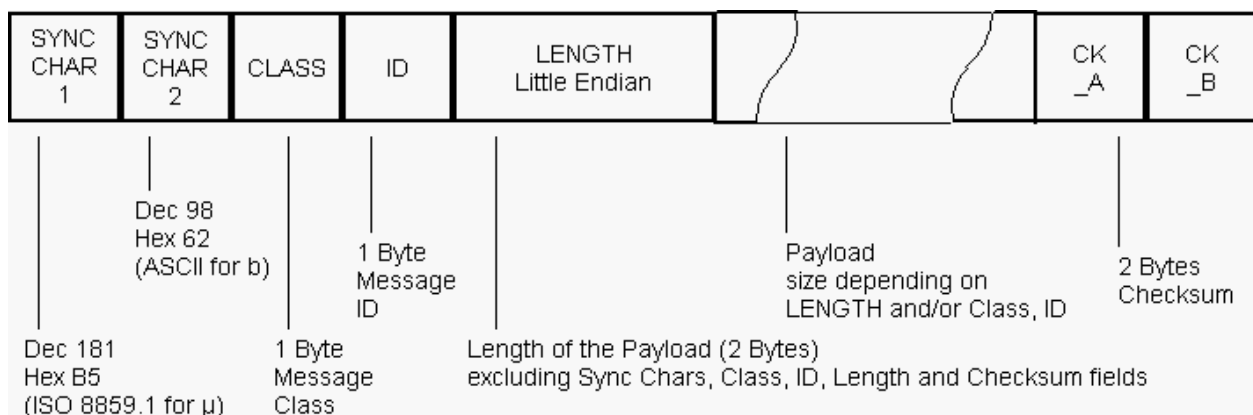

- Every Message starts with 2 Bytes: 0xB5 0x62
- A 1 Byte Class Field follows. The Class defines the basic subset of the message
- A 1 Byte ID Field defines the message that is to follow

- A 2 Byte Length Field is following. Length is defined as being the length of the payload, only. It does not include Sync Chars, Length Field, Class, ID or CRC fields. The number format of the length field is an unsigned 16-Bit integer in Little Endian Format.
- The Payload is a variable length field.
- CK_A and CK_B is a 16 Bit checksum whose calculation is defined below.

31.3 UBX Payload Definition Rules

31.3.1 Structure Packing

Values are placed in an order that structure packing is not a problem. This means that 2 byte values shall start on offsets which are a multiple of 2, 4 byte values shall start at a multiple of 4, and so on.

31.3.2 Reserved Elements

Some messages contain reserved fields or bits to allow for future expansion. The contents of these elements should be ignored in output messages and must be set to zero in input messages. Where a message is output and subsequently returned to the receiver as input message, reserved elements can either be explicitly set to zero or left with whatever value they were output with.

31.3.3 Undefined Values

The description of some fields provide specific meanings for specific values. For example, the field gnssId appears in many UBX messages and uses 0 to indicate GPS, 1 for SBAS and so on (see [Satellite Numbering](#) for details); however it is usually stored in a byte with far more possible values than the handful currently defined. All such undefined values are reserved for future expansion and therefore should not be used.

31.3.4 Message Naming

Referring to messages is done by adding the class name and a dash in front of the message name. For example, the ECEF-Message is referred to as UBX-NAV-POSECEF. Referring to values is done by adding a dash and the name, e.g. UBX-NAV-POSECEF-X

31.3.5 Number Formats

All multi-byte values are ordered in Little Endian format, unless otherwise indicated.

All floating point values are transmitted in IEEE754 single or double precision.

Variable Type Definitions

Short	Type	Size (Bytes)	Comment	Min/Max	Resolution
U1	Unsigned Char	1		0..255	1
RU1_3	Unsigned Char	1	binary floating point with 3 bit exponent, eeeb bbbb, (Value & 0x1F) << (Value >> 5)	0..(31*2^7) non-continuous	$\sim 2^{(Value \gg 5)}$
I1	Signed Char	1	2's complement	-128..127	1
X1	Bitfield	1		n/a	n/a
U2	Unsigned Short	2		0..65535	1
I2	Signed Short	2	2's complement	-32768..32767	1

Variable Type Definitions continued

Short	Type	Size (Bytes)	Comment	Min/Max	Resolution
X2	Bitfield	2		n/a	n/a
U4	Unsigned Long	4		0..4 '294'967'295	1
I4	Signed Long	4	2's complement	-2'147'483'648 .. 2'147'483'647	1
X4	Bitfield	4		n/a	n/a
R4	IEEE 754 Single Precision	4		-1*2 ⁺¹²⁷ .. 2 ⁺¹²⁷	~ Value * 2 ⁻²⁴
R8	IEEE 754 Double Precision	8		-1*2 ⁺¹⁰²³ .. 2 ⁺¹⁰²³	~ Value * 2 ⁻⁵³
CH	ASCII / ISO 8859.1 Encoding	1			

31.4 UBX Checksum

The checksum is calculated over the packet, starting and including the CLASS field, up until, but excluding, the Checksum Field:

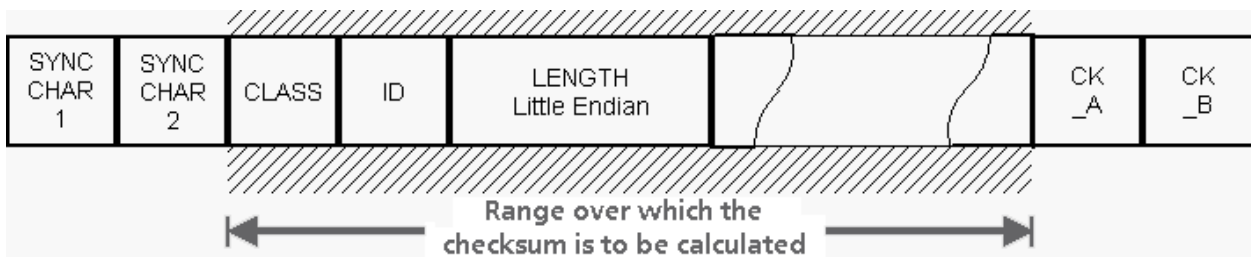

The checksum algorithm used is the 8-Bit Fletcher Algorithm, which is used in the TCP standard ([RFC 1145](#)). This algorithm works as follows:

Buffer[N] contains the data over which the checksum is to be calculated.

The two CK_ values are 8-Bit unsigned integers, only! If implementing with larger-sized integer values, make sure to mask both CK_A and CK_B with 0xFF after both operations in the loop.

```

CK_A = 0, CK_B = 0
For (I=0; I<N; I++)
{
    CK_A = CK_A + Buffer[I]
    CK_B = CK_B + CK_A
}
    
```

After the loop, the two U1 values contain the checksum, transmitted at the end of the packet.

31.5 UBX Message Flow

There are certain features associated with the messages being sent back and forth:

31.5.1 Acknowledgement

When messages from the class CFG are sent to the receiver, the receiver will send an "acknowledge" ([ACK-ACK](#)) or a "not acknowledge" ([ACK-NAK](#)) message back to the sender, depending on whether or not the message was processed correctly.

Some messages from other classes (e.g. LOG) also use the same acknowledgement mechanism.

31.5.2 Polling Mechanism

All messages that are output by the receiver in a periodic manner (i.e. messages in classes MON, NAV and RXM) can also be polled.

The UBX protocol is designed so that messages can be polled by sending the message required to the receiver but without a payload (or with just a single parameter that identifies the poll request). The receiver then responds with the same message with the payload populated.

31.6 UBX Satellite Numbering

UBX protocol messages use two different numbering schemes. Many UBX messages (e.g. [UBX-NAV-SVINFO](#)) use a single byte for the satellite identifier (normally named "svId"). This uses numbering similar to the "extended" NMEA scheme and is merely an extension of the scheme in use for previous generations of u-blox receivers.

With ever increasing numbers of GNSS satellites, this scheme will have to be phased out in future u-blox receivers (as numbers greater than 255 will become necessary). Consequently, newer messages use a more sophisticated, flexible and future-proof approach. This involves having a separate *gnssId* to identify which GNSS the satellite is part of and a simple *svId* which indicates which number the satellite is in that system. In nearly all cases, this means that the "svId" is the natural number associated with the satellite. For example the GLONASS SV4 is identified as *gnssId 6, svId 4*, while the GPS SV4 is *gnssId 0, svId 4*.

See [Satellite Numbering Summary](#) for a complete list of satellite numbers.

GNSS Identifiers

<i>gnssId</i>	GNSS
0	GPS
1	SBAS
2	Galileo
3	BeiDou
4	IMES
5	QZSS
6	GLONASS

Other values will be added as support for other GNSS types is enabled in u-blox receivers.

u-blox designates GPS, Galileo, BeiDou and GLONASS as major GNSS, and the others as augmentation systems. These designations are described in the section on [GNSS Types](#).



GLONASS satellites can be tracked before they have been identified. In UBX messages, such unknown satellite numbers are always reported with svId 255.

31.7 UBX Class IDs

A class is a grouping of messages which are related to each other. The following table lists all the current message classes.

Name	Class	Description
NAV	0x01	Navigation Results Messages: Position, Speed, Time, Acceleration, Heading, DOP, SVs used
RXM	0x02	Receiver Manager Messages: Satellite Status, RTC Status
INF	0x04	Information Messages: Printf-Style Messages, with IDs such as Error, Warning, Notice
ACK	0x05	Ack/Nak Messages: Acknowledge or Reject messages to CFG input messages
CFG	0x06	Configuration Input Messages: Set Dynamic Model, Set DOP Mask, Set Baud Rate, etc.

UBX Class IDs continued

<i>Name</i>	<i>Class</i>	<i>Description</i>
UPD	0x09	Firmware Update Messages: Memory/Flash erase/write, Reboot, Flash identification, etc.
MON	0x0A	Monitoring Messages: Communication Status, CPU Load, Stack Usage, Task Status
AID	0x0B	AssistNow Aiding Messages: Ephemeris, Almanac, other A-GPS data input
TIM	0x0D	Timing Messages: Time Pulse Output, Time Mark Results
ESF	0x10	External Sensor Fusion Messages: External Sensor Measurements and Status Information
MGA	0x13	Multiple GNSS Assistance Messages: Assistance data for various GNSS
LOG	0x21	Logging Messages: Log creation, deletion, info and retrieval
SEC	0x27	Security Feature Messages
HNR	0x28	High Rate Navigation Results Messages: High rate time, position, speed, heading

All remaining class IDs are reserved.

31.8 UBX Messages Overview

Page	Mnemonic	Cls/ID	Length	Type	Description
UBX Class ACK				Ack/Nak Messages	
142	ACK-ACK	0x05 0x01	2	Output	Message Acknowledged
142	ACK-NAK	0x05 0x00	2	Output	Message Not-Acknowledged
UBX Class AID				AssistNow Aiding Messages	
143	AID-ALM	0x0B 0x30	0	Poll Request	Poll GPS Aiding Almanac Data
143	AID-ALM	0x0B 0x30	1	Poll Request	Poll GPS Aiding Almanac Data for a SV
144	AID-ALM	0x0B 0x30	(8) or (40)	Input/Output	GPS Aiding Almanac Input/Output Message
144	AID-AOP	0x0B 0x33	0	Poll Request	Poll AssistNow Autonomous data, all satellites
145	AID-AOP	0x0B 0x33	1	Poll Request	Poll AssistNow Autonomous data, one GPS...
145	AID-AOP	0x0B 0x33	68	Input/Output	AssistNow Autonomous data
146	AID-EPH	0x0B 0x31	0	Poll Request	Poll GPS Aiding Ephemeris Data
147	AID-EPH	0x0B 0x31	1	Poll Request	Poll GPS Aiding Ephemeris Data for a SV
147	AID-EPH	0x0B 0x31	(8) or (104)	Input/Output	GPS Aiding Ephemeris Input/Output Message
148	AID-HUI	0x0B 0x02	0	Poll Request	Poll GPS Health, UTC, ionosphere parameters
148	AID-HUI	0x0B 0x02	72	Input/Output	GPS Health, UTC and ionosphere parameters
150	AID-INI	0x0B 0x01	0	Poll Request	Poll GPS Initial Aiding Data
150	AID-INI	0x0B 0x01	48	Input/Output	Aiding position, time, frequency, clock drift
UBX Class CFG				Configuration Input Messages	
153	CFG-ANT	0x06 0x13	4	Get/Set	Antenna Control Settings
154	CFG-CFG	0x06 0x09	(12) or (13)	Command	Clear, Save and Load configurations
156	CFG-DAT	0x06 0x06	44	Set	Set User-defined Datum.
156	CFG-DAT	0x06 0x06	52	Get	The currently defined Datum
157	CFG-DGNSS	0x06 0x70	4	Get/Set	DGNSS configuration
158	CFG-DOSC	0x06 0x61	4 + 32*numOsc	Get/Set	Disciplined oscillator configuration
159	CFG-DYNSEED	0x06 0x85	12	Set	Programming the dynamic seed for the host...
160	CFG-ESRC	0x06 0x60	4 + 36*numSo...	Get/Set	External synchronization source configuration
161	CFG-FIXSEED	0x06 0x84	12 + 2*length	Set	Programming the fixed seed for host...
162	CFG-GEOFENCE	0x06 0x69	8 + 12*numFe...	Get/Set	Geofencing configuration
163	CFG-GNSS	0x06 0x3E	4 + 8*numCo...	Get/Set	GNSS system configuration
165	CFG-HNR	0x06 0x5C	4	Get/Set	High Navigation Rate Settings
166	CFG-INF	0x06 0x02	1	Poll Request	Poll configuration for one protocol
166	CFG-INF	0x06 0x02	0 + 10*N	Get/Set	Information message configuration
167	CFG-ITFM	0x06 0x39	8	Get/Set	Jamming/Interference Monitor configuration
168	CFG-LOGFILTER	0x06 0x47	12	Get/Set	Data Logger Configuration
170	CFG-MSG	0x06 0x01	2	Poll Request	Poll a message configuration
170	CFG-MSG	0x06 0x01	8	Get/Set	Set Message Rate(s)
171	CFG-MSG	0x06 0x01	3	Get/Set	Set Message Rate

UBX Messages Overview continued

Page	Mnemonic	Cls/ID	Length	Type	Description
171	CFG-NAV5	0x06 0x24	36	Get/Set	Navigation Engine Settings
173	CFG-NAV5	0x06 0x23	40	Get/Set	Navigation Engine Expert Settings
175	CFG-NAV5	0x06 0x23	40	Get/Set	Navigation Engine Expert Settings
177	CFG-NMEA	0x06 0x17	4	Get/Set	NMEA protocol configuration (deprecated)
179	CFG-NMEA	0x06 0x17	12	Get/Set	NMEA protocol configuration V0 (deprecated)
181	CFG-NMEA	0x06 0x17	20	Get/Set	Extended NMEA protocol configuration V1
184	CFG-ODO	0x06 0x1E	20	Get/Set	Odometer, Low-speed COG Engine Settings
185	CFG-PM2	0x06 0x3B	44	Get/Set	Extended Power Management configuration
187	CFG-PM2	0x06 0x3B	48	Get/Set	Extended Power Management configuration
189	CFG-PMS	0x06 0x86	8	Get/Set	Power Mode Setup
190	CFG-PRT	0x06 0x00	1	Poll Request	Polls the configuration for one I/O Port
190	CFG-PRT	0x06 0x00	20	Get/Set	Port Configuration for UART
194	CFG-PRT	0x06 0x00	20	Get/Set	Port Configuration for USB Port
196	CFG-PRT	0x06 0x00	20	Get/Set	Port Configuration for SPI Port
198	CFG-PRT	0x06 0x00	20	Get/Set	Port Configuration for DDC Port
201	CFG-PWR	0x06 0x57	8	Set	Put receiver in a defined power state.
201	CFG-RATE	0x06 0x08	6	Get/Set	Navigation/Measurement Rate Settings
202	CFG-RINV	0x06 0x34	1 + 1*N	Get/Set	Contents of Remote Inventory
203	CFG-RST	0x06 0x04	4	Command	Reset Receiver / Clear Backup Data Structures
204	CFG-RXM	0x06 0x11	2	Get/Set	RXM configuration
205	CFG-RXM	0x06 0x11	2	Get/Set	RXM configuration
205	CFG-SBAS	0x06 0x16	8	Get/Set	SBAS Configuration
207	CFG-SMGR	0x06 0x62	20	Get/Set	Synchronization manager configuration
209	CFG-TMODE2	0x06 0x3D	28	Get/Set	Time Mode Settings 2
211	CFG-TMODE3	0x06 0x71	40	Get/Set	Time Mode Settings 3
212	CFG-TP5	0x06 0x31	0	Poll Request	Poll Time Pulse Parameters for Time Pulse 0
213	CFG-TP5	0x06 0x31	1	Poll Request	Poll Time Pulse Parameters
213	CFG-TP5	0x06 0x31	32	Get/Set	Time Pulse Parameters
214	CFG-TP5	0x06 0x31	32	Get/Set	Time Pulse Parameters
216	CFG-TXSLOT	0x06 0x53	16	Set	TX buffer time slots configuration
217	CFG-USB	0x06 0x1B	108	Get/Set	USB Configuration
UBX Class ESF				External Sensor Fusion Messages	
219	ESF-INS	0x10 0x15	36	Periodic/Polled	Vehicle dynamics information
220	ESF-MEAS	0x10 0x02	(8 + 4*N) or (1...	Input/Output	External Sensor Fusion Measurements
221	ESF-RAW	0x10 0x03	4 + 8*N	Output	Raw sensor measurements
222	ESF-STATUS	0x10 0x10	16 + 4*numSens	Periodic/Polled	External Sensor Fusion (ESF) status information
UBX Class HNR				High Rate Navigation Results Messages	
225	HNR-PVT	0x28 0x00	72	Periodic/Polled	High Rate Output of PVT Solution

UBX Messages Overview continued

Page	Mnemonic	Cls/ID	Length	Type	Description
UBX Class INF				Information Messages	
227	INF-DEBUG	0x04 0x04	0 + 1*N	Output	ASCII output with debug contents
227	INF-ERROR	0x04 0x00	0 + 1*N	Output	ASCII output with error contents
228	INF-NOTICE	0x04 0x02	0 + 1*N	Output	ASCII output with informational contents
228	INF-TEST	0x04 0x03	0 + 1*N	Output	ASCII output with test contents
229	INF-WARNING	0x04 0x01	0 + 1*N	Output	ASCII output with warning contents
UBX Class LOG				Logging Messages	
230	LOG-CREATE	0x21 0x07	8	Command	Create Log File
231	LOG-ERASE	0x21 0x03	0	Command	Erase Logged Data
231	LOG-FINDTIME	0x21 0x0E	12	Input	Find index of a log entry based on a given time
232	LOG-FINDTIME	0x21 0x0E	8	Output	Response to FINDTIME request.
232	LOG-INFO	0x21 0x08	0	Poll Request	Poll for log information
233	LOG-INFO	0x21 0x08	48	Output	Log information
234	LOG-RETRIEVEPOSE...	0x21 0x0f	32	Output	Odometer log entry
235	LOG-RETRIEVEPOS	0x21 0x0b	40	Output	Position fix log entry
236	LOG-RETRIEVESTRING	0x21 0x0d	16 + 1*byteC...	Output	Byte string log entry
236	LOG-RETRIEVE	0x21 0x09	12	Command	Request log data
237	LOG-STRING	0x21 0x04	0 + 1*N	Command	Store arbitrary string in on-board flash
UBX Class MGA				Multiple GNSS Assistance Messages	
238	MGA-ACK-DATA0	0x13 0x60	8	Output	Multiple GNSS Acknowledge message
239	MGA-ANO	0x13 0x20	76	Input	Multiple GNSS AssistNow Offline Assistance
239	MGA-BDS-EPH	0x13 0x03	88	Input	BDS Ephemeris Assistance
241	MGA-BDS-ALM	0x13 0x03	40	Input	BDS Almanac Assistance
242	MGA-BDS-HEALTH	0x13 0x03	68	Input	BDS Health Assistance
242	MGA-BDS-UTC	0x13 0x03	20	Input	BDS UTC Assistance
243	MGA-BDS-IONO	0x13 0x03	16	Input	BDS Ionospheric Assistance
244	MGA-DBD	0x13 0x80	0	Poll Request	Poll the Navigation Database
244	MGA-DBD	0x13 0x80	12 + 1*N	Input/Output	Navigation Database Dump Entry
245	MGA-FLASH-DATA	0x13 0x21	6 + 1*size	Input	Transfer MGA-ANO data block to flash
245	MGA-FLASH-STOP	0x13 0x21	2	Input	Finish flashing MGA-ANO data
246	MGA-FLASH-ACK	0x13 0x21	6	Output	Acknowledge last FLASH-DATA or -STOP
247	MGA-GAL-EPH	0x13 0x02	76	Input	Galileo Ephemeris Assistance
248	MGA-GAL-ALM	0x13 0x02	32	Input	Galileo Almanac Assistance
249	MGA-GAL-TIMEOFF...	0x13 0x02	12	Input	Galileo GPS time offset assistance
250	MGA-GAL-UTC	0x13 0x02	20	Input	Galileo UTC Assistance
250	MGA-GLO-EPH	0x13 0x06	48	Input	GLONASS Ephemeris Assistance
252	MGA-GLO-ALM	0x13 0x06	36	Input	GLONASS Almanac Assistance
253	MGA-GLO-TIMEOFF...	0x13 0x06	20	Input	GLONASS Auxiliary Time Offset Assistance

UBX Messages Overview continued

Page	Mnemonic	Cls/ID	Length	Type	Description
253	MGA-GPS-EPH	0x13 0x00	68	Input	GPS Ephemeris Assistance
255	MGA-GPS-ALM	0x13 0x00	36	Input	GPS Almanac Assistance
256	MGA-GPS-HEALTH	0x13 0x00	40	Input	GPS Health Assistance
256	MGA-GPS-UTC	0x13 0x00	20	Input	GPS UTC Assistance
257	MGA-GPS-IONO	0x13 0x00	16	Input	GPS Ionosphere Assistance
258	MGA-INI-POS_XYZ	0x13 0x40	20	Input	Initial Position Assistance
258	MGA-INI-POS_LLH	0x13 0x40	20	Input	Initial Position Assistance
259	MGA-INI-TIME_UTC	0x13 0x40	24	Input	Initial Time Assistance
260	MGA-INI-TIME_GNSS	0x13 0x40	24	Input	Initial Time Assistance
261	MGA-INI-CLKD	0x13 0x40	12	Input	Initial Clock Drift Assistance
262	MGA-INI-FREQ	0x13 0x40	12	Input	Initial Frequency Assistance
263	MGA-INI-EOP	0x13 0x40	72	Input	Earth Orientation Parameters Assistance
263	MGA-QZSS-EPH	0x13 0x05	68	Input	QZSS Ephemeris Assistance
265	MGA-QZSS-ALM	0x13 0x05	36	Input	QZSS Almanac Assistance
266	MGA-QZSS-HEALTH	0x13 0x05	12	Input	QZSS Health Assistance
UBX Class MON				Monitoring Messages	
267	MON-GNSS	0x0A 0x28	8	Polled	Information message major GNSS selection
269	MON-HW2	0x0A 0x0B	28	Periodic/Polled	Extended Hardware Status
270	MON-HW	0x0A 0x09	60	Periodic/Polled	Hardware Status
271	MON-IO	0x0A 0x02	0 + 20*N	Periodic/Polled	I/O Subsystem Status
272	MON-MSGPP	0x0A 0x06	120	Periodic/Polled	Message Parse and Process Status
272	MON-PATCH	0x0A 0x27	0	Poll Request	Poll Request for installed patches
273	MON-PATCH	0x0A 0x27	4 + 16*nEntries	Polled	Output information about installed patches.
274	MON-RXBUF	0x0A 0x07	24	Periodic/Polled	Receiver Buffer Status
274	MON-RXR	0x0A 0x21	1	Output	Receiver Status Information
275	MON-SMGR	0x0A 0x2E	16	Periodic/Polled	Synchronization Manager Status
278	MON-TXBUF	0x0A 0x08	28	Periodic/Polled	Transmitter Buffer Status
279	MON-VER	0x0A 0x04	0	Poll Request	Poll Receiver/Software Version
279	MON-VER	0x0A 0x04	40 + 30*N	Polled	Receiver/Software Version
UBX Class NAV				Navigation Results Messages	
280	NAV-AOPSTATUS	0x01 0x60	16	Periodic/Polled	AssistNow Autonomous Status
281	NAV-ATT	0x01 0x05	32	Periodic/Polled	Attitude Solution
281	NAV-CLOCK	0x01 0x22	20	Periodic/Polled	Clock Solution
282	NAV-DGPS	0x01 0x31	16 + 12*numCh	Periodic/Polled	DGPS Data Used for NAV
283	NAV-DOP	0x01 0x04	18	Periodic/Polled	Dilution of precision
284	NAV-EOE	0x01 0x61	4	Periodic	End Of Epoch
284	NAV-GEOFENCE	0x01 0x39	8 + 2*numFen...	Periodic/Polled	Geofencing status
285	NAV-HPOSECEF	0x01 0x13	28	Periodic/Polled	High Precision Position Solution in ECEF

UBX Messages Overview continued

Page	Mnemonic	Cls/ID	Length	Type	Description
286	NAV-HPPOSLLH	0x01 0x14	36	Periodic/Polled	High Precision Geodetic Position Solution
287	NAV-ODO	0x01 0x09	20	Periodic/Polled	Odometer Solution
287	NAV-ORB	0x01 0x34	8 + 6*numSv	Periodic/Polled	GNSS Orbit Database Info
290	NAV-POSECEF	0x01 0x01	20	Periodic/Polled	Position Solution in ECEF
290	NAV-POSLLH	0x01 0x02	28	Periodic/Polled	Geodetic Position Solution
291	NAV-PVT	0x01 0x07	92	Periodic/Polled	Navigation Position Velocity Time Solution
294	NAV-RELPOSNED	0x01 0x3C	40	Periodic/Polled	Relative Positioning Information in NED frame
296	NAV-RESETO	0x01 0x10	0	Command	Reset odometer
296	NAV-SAT	0x01 0x35	8 + 12*numSvs	Periodic/Polled	Satellite Information
298	NAV-SBAS	0x01 0x32	12 + 12*cnt	Periodic/Polled	SBAS Status Data
299	NAV-SOL	0x01 0x06	52	Periodic/Polled	Navigation Solution Information
301	NAV-STATUS	0x01 0x03	16	Periodic/Polled	Receiver Navigation Status
303	NAV-SVINFO	0x01 0x30	8 + 12*numCh	Periodic/Polled	Space Vehicle Information
305	NAV-SVIN	0x01 0x3B	40	Periodic/Polled	Survey-in data
306	NAV-TIMEBDS	0x01 0x24	20	Periodic/Polled	BDS Time Solution
307	NAV-TIMEGAL	0x01 0x25	20	Periodic/Polled	Galileo Time Solution
308	NAV-TIMEGLO	0x01 0x23	20	Periodic/Polled	GLO Time Solution
309	NAV-TIMEGPS	0x01 0x20	16	Periodic/Polled	GPS Time Solution
310	NAV-TIMELS	0x01 0x26	24	Periodic/Polled	Leap second event information
312	NAV-TIMEUTC	0x01 0x21	20	Periodic/Polled	UTC Time Solution
313	NAV-VELECEF	0x01 0x11	20	Periodic/Polled	Velocity Solution in ECEF
314	NAV-VELNED	0x01 0x12	36	Periodic/Polled	Velocity Solution in NED
UBX Class RXM				Receiver Manager Messages	
315	RXM-IMES	0x02 0x61	4 + 44*numTx	Periodic/Polled	Indoor Messaging System Information
317	RXM-MEASX	0x02 0x14	44 + 24*numSV	Periodic	Satellite Measurements for RRLP
319	RXM-PMREQ	0x02 0x41	8	Command	Requests a Power Management task
320	RXM-PMREQ	0x02 0x41	16	Command	Requests a Power Management task
321	RXM-RAWX	0x02 0x15	16 + 32*num...	Periodic/Polled	Multi-GNSS Raw Measurement Data
324	RXM-RAWX	0x02 0x15	16 + 32*num...	Periodic/Polled	Multi-GNSS Raw Measurement Data
327	RXM-RLM	0x02 0x59	16	Output	Galileo SAR Short-RLM report
328	RXM-RLM	0x02 0x59	28	Output	Galileo SAR Long-RLM report
328	RXM-RTCM	0x02 0x32	8	Output	RTCM input status
329	RXM-SFRBX	0x02 0x13	8 + 4*numWo...	Output	Broadcast Navigation Data Subframe
330	RXM-SFRBX	0x02 0x13	8 + 4*numWo...	Output	Broadcast Navigation Data Subframe
330	RXM-SVSI	0x02 0x20	8 + 6*numSV	Periodic/Polled	SV Status Info
UBX Class SEC				Security Feature Messages	
333	SEC-SIGN	0x27 0x01	40	Output	Signature of a previous message
333	SEC-UNIQID	0x27 0x03	9	Output	Unique Chip ID

UBX Messages Overview continued

Page	Mnemonic	Cls/ID	Length	Type	Description
UBX Class TIM				Timing Messages	
334	TIM-DOSC	0x0D 0x11	8	Output	Disciplined oscillator control
334	TIM-FCHG	0x0D 0x16	32	Periodic/Polled	Oscillator frequency changed notification
335	TIM-HOC	0x0D 0x17	8	Input	Host oscillator control
336	TIM-SMEAS	0x0D 0x13	12 + 24*num...	Input/Output	Source measurement
338	TIM-SVIN	0x0D 0x04	28	Periodic/Polled	Survey-in data
339	TIM-TM2	0x0D 0x03	28	Periodic/Polled	Time mark data
340	TIM-TOS	0x0D 0x12	56	Periodic	Time Pulse Time and Frequency Data
342	TIM-TP	0x0D 0x01	16	Periodic/Polled	Time Pulse Timedata
344	TIM-VCOCAL	0x0D 0x15	1	Command	Stop calibration
344	TIM-VCOCAL	0x0D 0x15	12	Command	VCO calibration extended command
345	TIM-VCOCAL	0x0D 0x15	12	Periodic/Polled	Results of the calibration
346	TIM-VRFY	0x0D 0x06	20	Periodic/Polled	Sourced Time Verification
UBX Class UPD				Firmware Update Messages	
347	UPD-SOS	0x09 0x14	0	Poll Request	Poll Backup File Restore Status
347	UPD-SOS	0x09 0x14	4	Command	Create Backup File in Flash
348	UPD-SOS	0x09 0x14	4	Command	Clear Backup in Flash
348	UPD-SOS	0x09 0x14	8	Output	Backup File Creation Acknowledge
349	UPD-SOS	0x09 0x14	8	Output	System Restored from Backup

31.9 UBX-ACK (0x05)

Ack/Nak Messages: i.e. Acknowledge or Reject messages to CFG input messages.

Messages in the ACK class output the processing results to CFG and some other messages (like [UBX-LOG-CREATE](#)).

31.9.1 UBX-ACK-ACK (0x05 0x01)

31.9.1.1 Message Acknowledged

<i>Message</i>	ACK-ACK					
<i>Description</i>	Message Acknowledged					
<i>Firmware</i>	Supported on: <ul style="list-style-type: none"> u-blox 8 / u-blox M8 from protocol version 15 up to version 23.01 					
<i>Type</i>	Output					
<i>Comment</i>	Output upon processing of an input message					
<i>Message Structure</i>	<i>Header</i>	<i>Class</i>	<i>ID</i>	<i>Length (Bytes)</i>	<i>Payload</i>	<i>Checksum</i>
	0xB5 0x62	0x05	0x01	2	see below	CK_A CK_B
<i>Payload Contents:</i>						
<i>Byte Offset</i>	<i>Number Format</i>	<i>Scaling</i>	<i>Name</i>	<i>Unit</i>	<i>Description</i>	
0	U1	-	clsID	-	Class ID of the Acknowledged Message	
1	U1	-	msgID	-	Message ID of the Acknowledged Message	

31.9.2 UBX-ACK-NAK (0x05 0x00)

31.9.2.1 Message Not-Acknowledged

<i>Message</i>	ACK-NAK					
<i>Description</i>	Message Not-Acknowledged					
<i>Firmware</i>	Supported on: <ul style="list-style-type: none"> u-blox 8 / u-blox M8 from protocol version 15 up to version 23.01 					
<i>Type</i>	Output					
<i>Comment</i>	Output upon processing of an input message					
<i>Message Structure</i>	<i>Header</i>	<i>Class</i>	<i>ID</i>	<i>Length (Bytes)</i>	<i>Payload</i>	<i>Checksum</i>
	0xB5 0x62	0x05	0x00	2	see below	CK_A CK_B
<i>Payload Contents:</i>						
<i>Byte Offset</i>	<i>Number Format</i>	<i>Scaling</i>	<i>Name</i>	<i>Unit</i>	<i>Description</i>	
0	U1	-	clsID	-	Class ID of the Not-Acknowledged Message	
1	U1	-	msgID	-	Message ID of the Not-Acknowledged Message	

31.10 UBX-AID (0x0B)

AssistNow Aiding Messages: i.e. Ephemeris, Almanac, other A-GPS data input. Messages in the AID class are used to send GPS aiding data to the receiver.

31.10.1 UBX-AID-ALM (0x0B 0x30)

31.10.1.1 Poll GPS Aiding Almanac Data

Message	AID-ALM					
Description	Poll GPS Aiding Almanac Data					
Firmware	Supported on: <ul style="list-style-type: none"> u-blox 8 / u-blox M8 from protocol version 15 up to version 23.01 					
Type	Poll Request					
Comment	All UBX-AID messages are deprecated; use UBX-MGA messages instead Poll GPS Aiding Data (Almanac) for all 32 SVs by sending this message to the receiver without any payload. The receiver will return 32 messages of type AID-ALM as defined below.					
Message Structure	Header	Class	ID	Length (Bytes)	Payload	Checksum
	0xB5 0x62	0x0B	0x30	0	see below	CK_A CK_B
No payload						

31.10.1.2 Poll GPS Aiding Almanac Data for a SV

Message	AID-ALM					
Description	Poll GPS Aiding Almanac Data for a SV					
Firmware	Supported on: <ul style="list-style-type: none"> u-blox 8 / u-blox M8 from protocol version 15 up to version 23.01 					
Type	Poll Request					
Comment	All UBX-AID messages are deprecated; use UBX-MGA messages instead Poll GPS Aiding Data (Almanac) for an SV by sending this message to the receiver. The receiver will return one message of type AID-ALM as defined below.					
Message Structure	Header	Class	ID	Length (Bytes)	Payload	Checksum
	0xB5 0x62	0x0B	0x30	1	see below	CK_A CK_B
Payload Contents:						
Byte Offset	Number Format	Scaling	Name	Unit	Description	
0	U1	-	svid	-	SV ID for which the receiver shall return its Almanac Data (Valid Range: 1 .. 32 or 51, 56, 63).	

31.10.1.3 GPS Aiding Almanac Input/Output Message

Message	AID-ALM					
Description	GPS Aiding Almanac Input/Output Message					
Firmware	Supported on: <ul style="list-style-type: none"> u-blox 8 / u-blox M8 from protocol version 15 up to version 23.01 					
Type	Input/Output					
Comment	All UBX-AID messages are deprecated; use UBX-MGA messages instead <ul style="list-style-type: none"> If the WEEK Value is 0, DWRD0 to DWRD7 are not sent as the Almanac is not available for the given SV. This may happen even if NAV-SVINFO and RXM-SVSI are indicating almanac availability as the internal data may not represent the content of an original broadcast almanac (or only parts thereof). DWORD0 to DWORD7 contain the 8 words following the Hand-Over Word (HOW) from the GPS navigation message, either pages 1 to 24 of sub-frame 5 or pages 2 to 10 of subframe 4. See IS-GPS-200 for a full description of the contents of the Almanac pages. In DWORD0 to DWORD7, the parity bits have been removed, and the 24 bits of data are located in Bits 0 to 23. Bits 24 to 31 shall be ignored. Example: Parameter e (Eccentricity) from Almanac Subframe 4/5, Word 3, Bits 69-84 within the subframe can be found in DWRD0, Bits 15-0 whereas Bit 0 is the LSB. 					
Message Structure	Header	Class	ID	Length (Bytes)	Payload	Checksum
	0xB5 0x62	0x0B	0x30	(8) or (40)	see below	CK_A CK_B
Payload Contents:						
Byte Offset	Number Format	Scaling	Name	Unit	Description	
0	U4	-	svid	-	SV ID for which this Almanac Data is (Valid Range: 1 .. 32 or 51, 56, 63).	
4	U4	-	week	-	Issue Date of Almanac (GPS week number)	
Start of optional block						
8	U4[8]	-	dwrđ	-	Almanac Words	
End of optional block						

31.10.2 UBX-AID-AOP (0x0B 0x33)

31.10.2.1 Poll AssistNow Autonomous data, all satellites

Message	AID-AOP					
Description	Poll AssistNow Autonomous data, all satellites					
Firmware	Supported on: <ul style="list-style-type: none"> u-blox 8 / u-blox M8 from protocol version 15 up to version 23.01 					
Type	Poll Request					
Comment	All UBX-AID messages are deprecated; use UBX-MGA messages instead <p>Poll <i>AssistNow Autonomous</i> aiding data for all GPS satellites by sending this empty message. The receiver will return an AID-AOP message (see definition below) for each GPS satellite for which data is available.</p>					
Message Structure	Header	Class	ID	Length (Bytes)	Payload	Checksum
	0xB5 0x62	0x0B	0x33	0	see below	CK_A CK_B

No payload

31.10.2.2 Poll AssistNow Autonomous data, one GPS satellite

Message	AID-AOP					
Description	Poll AssistNow Autonomous data, one GPS satellite					
Firmware	Supported on: <ul style="list-style-type: none"> u-blox 8 / u-blox M8 from protocol version 15 up to version 23.01 					
Type	Poll Request					
Comment	All UBX-AID messages are deprecated; use UBX-MGA messages instead Poll the <i>AssistNow Autonomous</i> data for the specified GPS satellite. The receiver will return a AID-AOP message (see definition below) if data is available for the requested satellite.					
Message Structure	Header	Class	ID	Length (Bytes)	Payload	Checksum
	0xB5 0x62	0x0B	0x33	1	see below	CK_A CK_B
Payload Contents:						
Byte Offset	Number Format	Scaling	Name	Unit	Description	
0	U1	-	svid	-	GPS SV ID for which the data is requested (valid range: 1..32).	

31.10.2.3 AssistNow Autonomous data

Message	AID-AOP					
Description	AssistNow Autonomous data					
Firmware	Supported on: <ul style="list-style-type: none"> u-blox 8 / u-blox M8 from protocol version 15 up to version 23.01 					
Type	Input/Output					
Comment	All UBX-AID messages are deprecated; use UBX-MGA messages instead If enabled, this message is output at irregular intervals. It is output whenever <i>AssistNow Autonomous</i> has produced new data for a satellite. Depending on the availability of the optional data the receiver will output either version of the message. If this message is polled using one of the two poll requests described above the receiver will send this message if AssistNow Autonomous data is available or the corresponding poll request message if no AssistNow Autonomous data is available for each satellite (i.e. svid 1..32). At the user's choice the optional data may be chopped from the payload of a previously polled message when sending the message back to the receiver. Sending a valid AID-AOP message to the receiver will automatically enable the <i>AssistNow Autonomous</i> feature on the receiver. See the section AssistNow Autonomous in the receiver description for details on this feature.					
Message Structure	Header	Class	ID	Length (Bytes)	Payload	Checksum
	0xB5 0x62	0x0B	0x33	68	see below	CK_A CK_B
Payload Contents:						
Byte Offset	Number Format	Scaling	Name	Unit	Description	
0	U1	-	gnssId	-	GNSS identifier (see Satellite Numbering)	
1	U1	-	svId	-	Satellite identifier (see Satellite Numbering)	
2	U1[2]	-	reserved1	-	Reserved	

AID-AOP continued

Byte Offset	Number Format	Scaling	Name	Unit	Description
4	U1[64]	-	data	-	assistance data

31.10.3 UBX-AID-EPH (0x0B 0x31)

31.10.3.1 Poll GPS Aiding Ephemeris Data

Message	AID-EPH					
Description	Poll GPS Aiding Ephemeris Data					
Firmware	Supported on: <ul style="list-style-type: none"> u-blox 8 / u-blox M8 from protocol version 15 up to version 23.01 					
Type	Poll Request					
Comment	All UBX-AID messages are deprecated; use UBX-MGA messages instead Poll GPS Aiding Data (Ephemeris) for all 32 SVs by sending this message to the receiver without any payload. The receiver will return 32 messages of type AID-EPH as defined below.					
Message Structure	Header	Class	ID	Length (Bytes)	Payload	Checksum
	0xB5 0x62	0x0B	0x31	0	see below	CK_A CK_B
No payload						

31.10.3.2 Poll GPS Aiding Ephemeris Data for a SV

Message		AID-EPH					
Description		Poll GPS Aiding Ephemeris Data for a SV					
Firmware		Supported on: <ul style="list-style-type: none"> • u-blox 8 / u-blox M8 from protocol version 15 up to version 23.01 					
Type		Poll Request					
Comment		All UBX-AID messages are deprecated; use UBX-MGA messages instead Poll GPS Constellation Data (Ephemeris) for an SV by sending this message to the receiver. The receiver will return one message of type AID-EPH as defined below.					
Message Structure		Header	Class	ID	Length (Bytes)	Payload	Checksum
		0xB5 0x62	0x0B	0x31	1	see below	CK_A CK_B
Payload Contents:							
Byte Offset	Number Format	Scaling	Name	Unit	Description		
0	U1	-	svid	-	SV ID for which the receiver shall return its Ephemeris Data (Valid Range: 1 .. 32).		

31.10.3.3 GPS Aiding Ephemeris Input/Output Message

Message		AID-EPH					
Description		GPS Aiding Ephemeris Input/Output Message					
Firmware		Supported on: <ul style="list-style-type: none"> • u-blox 8 / u-blox M8 from protocol version 15 up to version 23.01 					
Type		Input/Output					
Comment		All UBX-AID messages are deprecated; use UBX-MGA messages instead <ul style="list-style-type: none"> • SF1D0 to SF3D7 is only sent if ephemeris is available for this SV. If not, the payload may be reduced to 8 Bytes, or all bytes are set to zero, indicating that this SV Number does not have valid ephemeris for the moment. This may happen even if NAV-SVINFO and RXM-SVSI are indicating ephemeris availability as the internal data may not represent the content of an original broadcast ephemeris (or only parts thereof). • SF1D0 to SF3D7 contain the 24 words following the Hand-Over Word (HOW) from the GPS navigation message, subframes 1 to 3. The Truncated TOW Count is not valid and cannot be used. See IS-GPS-200 for a full description of the contents of the Subframes. • In SF1D0 to SF3D7, the parity bits have been removed, and the 24 bits of data are located in Bits 0 to 23. Bits 24 to 31 shall be ignored. • When polled, the data contained in this message does not represent the full original ephemeris broadcast. Some fields that are irrelevant to u-blox receivers may be missing. The week number in Subframe 1 has already been modified to match the Time Of Ephemeris (TOE). 					
Message Structure		Header	Class	ID	Length (Bytes)	Payload	Checksum
		0xB5 0x62	0x0B	0x31	(8) or (104)	see below	CK_A CK_B
Payload Contents:							
Byte Offset	Number Format	Scaling	Name	Unit	Description		
0	U4	-	svid	-	SV ID for which this ephemeris data is (Valid Range: 1 .. 32).		

AID-EPH continued

Byte Offset	Number Format	Scaling	Name	Unit	Description
4	U4	-	how	-	Hand-Over Word of first Subframe. This is required if data is sent to the receiver. 0 indicates that no Ephemeris Data is following.
<i>Start of optional block</i>					
8	U4[8]	-	sf1d	-	Subframe 1 Words 3..10 (SF1D0..SF1D7)
40	U4[8]	-	sf2d	-	Subframe 2 Words 3..10 (SF2D0..SF2D7)
72	U4[8]	-	sf3d	-	Subframe 3 Words 3..10 (SF3D0..SF3D7)
<i>End of optional block</i>					

31.10.4 UBX-AID-HUI (0x0B 0x02)
31.10.4.1 Poll GPS Health, UTC, ionosphere parameters

Message	AID-HUI					
Description	Poll GPS Health, UTC, ionosphere parameters					
Firmware	Supported on: <ul style="list-style-type: none"> u-blox 8 / u-blox M8 from protocol version 15 up to version 23.01 					
Type	Poll Request					
Comment	All UBX-AID messages are deprecated; use UBX-MGA messages instead -					
Message Structure	Header	Class	ID	Length (Bytes)	Payload	Checksum
	0xB5 0x62	0x0B	0x02	0	see below	CK_A CK_B
No payload						

31.10.4.2 GPS Health, UTC and ionosphere parameters

Message	AID-HUI					
Description	GPS Health, UTC and ionosphere parameters					
Firmware	Supported on: <ul style="list-style-type: none"> u-blox 8 / u-blox M8 from protocol version 15 up to version 23.01 					
Type	Input/Output					
Comment	All UBX-AID messages are deprecated; use UBX-MGA messages instead This message contains a health bit mask, UTC time and Klobuchar parameters. For more information on these parameters, see the ICD-GPS-200 documentation.					
Message Structure	Header	Class	ID	Length (Bytes)	Payload	Checksum
	0xB5 0x62	0x0B	0x02	72	see below	CK_A CK_B
<i>Payload Contents:</i>						
Byte Offset	Number Format	Scaling	Name	Unit	Description	
0	X4	-	health	-	Bitmask, every bit represent a GPS SV (1-32). If the bit is set the SV is healthy.	
4	R8	-	utcA0	-	UTC - parameter A0	
12	R8	-	utcA1	-	UTC - parameter A1	
20	I4	-	utcTOW	-	UTC - reference time of week	
24	I2	-	utcWNT	-	UTC - reference week number	

AID-HUI continued

Byte Offset	Number Format	Scaling	Name	Unit	Description
26	I2	-	utcLS	-	UTC - time difference due to leap seconds before event
28	I2	-	utcWNF	-	UTC - week number when next leap second event occurs
30	I2	-	utcDN	-	UTC - day of week when next leap second event occurs
32	I2	-	utcLSF	-	UTC - time difference due to leap seconds after event
34	I2	-	utcSpare	-	UTC - Spare to ensure structure is a multiple of 4 bytes
36	R4	-	klobA0	s	Klobuchar - alpha 0
40	R4	-	klobA1	s/semicircle	Klobuchar - alpha 1
44	R4	-	klobA2	s/semicircle ²	Klobuchar - alpha 2
48	R4	-	klobA3	s/semicircle ³	Klobuchar - alpha 3
52	R4	-	klobB0	s	Klobuchar - beta 0
56	R4	-	klobB1	s/semicircle	Klobuchar - beta 1
60	R4	-	klobB2	s/semicircle ²	Klobuchar - beta 2
64	R4	-	klobB3	s/semicircle ³	Klobuchar - beta 3
68	X4	-	flags	-	flags (see graphic below)

Bitfield flags

This graphic explains the bits of flags

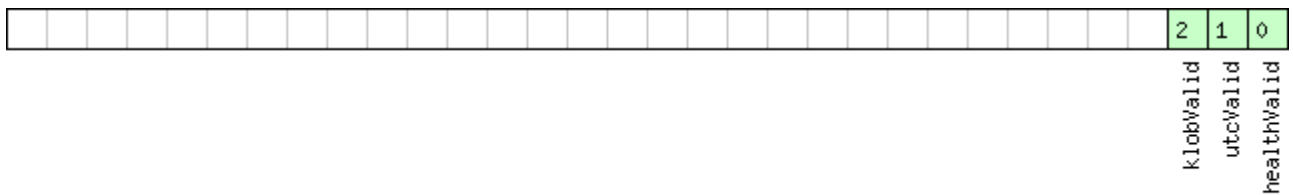

- signed value
- unsigned value
- reserved

Name	Description
healthValid	Healthmask field in this message is valid
utcValid	UTC parameter fields in this message are valid
klobValid	Klobuchar parameter fields in this message are valid

31.10.5 UBX-AID-INI (0x0B 0x01)

31.10.5.1 Poll GPS Initial Aiding Data

Message	AID-INI					
Description	Poll GPS Initial Aiding Data					
Firmware	Supported on: <ul style="list-style-type: none"> u-blox 8 / u-blox M8 from protocol version 15 up to version 23.01 					
Type	Poll Request					
Comment	All UBX-AID messages are deprecated; use UBX-MGA messages instead -					
Message Structure	Header	Class	ID	Length (Bytes)	Payload	Checksum
	0xB5 0x62	0x0B	0x01	0	see below	CK_A CK_B
No payload						

31.10.5.2 Aiding position, time, frequency, clock drift

Message	AID-INI					
Description	Aiding position, time, frequency, clock drift					
Firmware	Supported on: <ul style="list-style-type: none"> u-blox 8 / u-blox M8 from protocol version 15 up to version 23.01 					
Type	Input/Output					
Comment	All UBX-AID messages are deprecated; use UBX-MGA messages instead This message contains position, time and clock drift information. The position can be input in either the ECEF X/Y/Z coordinate system or as lat/lon/height. The time can either be input as inexact value via the standard communication interface, suffering from latency depending on the baud rate, or using hardware time synchronization where an accurate time pulse is input on the external interrupts. It is also possible to supply hardware frequency aiding by connecting a continuous signal to an external interrupt.					
Message Structure	Header	Class	ID	Length (Bytes)	Payload	Checksum
	0xB5 0x62	0x0B	0x01	48	see below	CK_A CK_B
Payload Contents:						
Byte Offset	Number Format	Scaling	Name	Unit	Description	
0	I4	-	ecefXOrLat	cm_or_deg*1e-7	WGS84 ECEF X coordinate or latitude, depending on flags below	
4	I4	-	ecefYOrLon	cm_or_deg*1e-7	WGS84 ECEF Y coordinate or longitude, depending on flags below	
8	I4	-	ecefZOrAlt	cm	WGS84 ECEF Z coordinate or altitude, depending on flags below	
12	U4	-	posAcc	cm	Position accuracy (stddev)	
16	X2	-	tmCfg	-	Time mark configuration (see graphic below)	
18	U2	-	wnoOrDate	week_or_year_Month	Actual week number or yearSince2000/Month (YYMM), depending on flags below	

AID-INI continued

Byte Offset	Number Format	Scaling	Name	Unit	Description
20	U4	-	towOrTime	ms_or_ dayHour rMinute Sec	Actual time of week or DayOfMonth/Hour/Minute/Second (DDHHMMSS), depending on flags below
24	I4	-	towNs	ns	Fractional part of time of week
28	U4	-	tAccMs	ms	Milliseconds part of time accuracy
32	U4	-	tAccNs	ns	Nanoseconds part of time accuracy
36	I4	-	clkDOrFreq	ns/s_or _Hz*1e -2	Clock drift or frequency, depending on flags below
40	U4	-	clkDAccOrFreq Acc	ns/s_or _ppb	Accuracy of clock drift or frequency, depending on flags below
44	X4	-	flags	-	Bitmask with the following flags (see graphic below)

Bitfield tmCfg

This graphic explains the bits of tmCfg

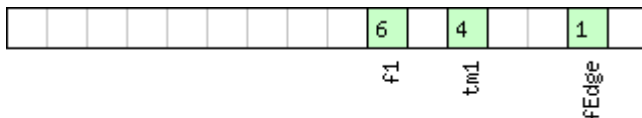

- signed value
- unsigned value
- reserved

Name	Description
fEdge	use falling edge (default rising)
tm1	time mark on extint 1 (default extint 0)
f1	frequency on extint 1 (default extint 0)

Bitfield flags

This graphic explains the bits of flags

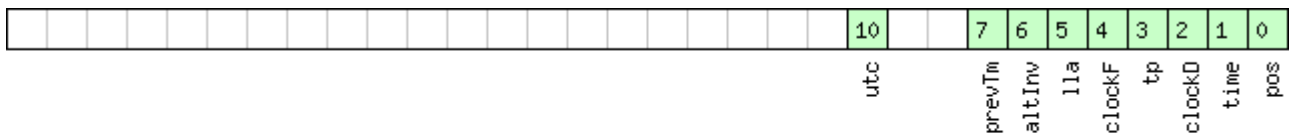

- signed value
- unsigned value
- reserved

Name	Description
pos	Position is valid
time	Time is valid
clockD	Clock drift data contains valid clock drift, must not be set together with clockF
tp	Use time pulse
clockF	Clock drift data contains valid frequency, must not be set together with clockD
lla	Position is given in lat/long/alt (default is ECEF)
altInv	Altitude is not valid, if lla was set

Bitfield flags Description continued

<i>Name</i>	<i>Description</i>
<code>prevTm</code>	Use time mark received before AID-INI message (default uses mark received after message)
<code>utc</code>	Time is given as UTC date/time (default is GPS wno/tow)

31.11 UBX-CFG (0x06)

Configuration Input Messages: i.e. Set Dynamic Model, Set DOP Mask, Set Baud Rate, etc..

Messages in the CFG class are used to configure the receiver and read out current configuration values. Any messages in the CFG class sent to the receiver are either acknowledged (with message [UBX-ACK-ACK](#)) if processed successfully or rejected (with message [UBX-ACK-NAK](#)) if processing unsuccessfully.

31.11.1 UBX-CFG-ANT (0x06 0x13)

31.11.1.1 Antenna Control Settings

Message	CFG-ANT					
Description	Antenna Control Settings					
Firmware	Supported on: <ul style="list-style-type: none"> • u-blox 8 / u-blox M8 from protocol version 15 up to version 23.01 					
Type	Get/Set					
Comment	-					
Message Structure	Header	Class	ID	Length (Bytes)	Payload	Checksum
	0xB5 0x62	0x06	0x13	4	see below	CK_A CK_B
Payload Contents:						
Byte Offset	Number Format	Scaling	Name	Unit	Description	
0	X2	-	flags	-	Antenna Flag Mask (see graphic below)	
2	X2	-	pins	-	Antenna Pin Configuration (see graphic below)	

Bitfield flags

This graphic explains the bits of flags

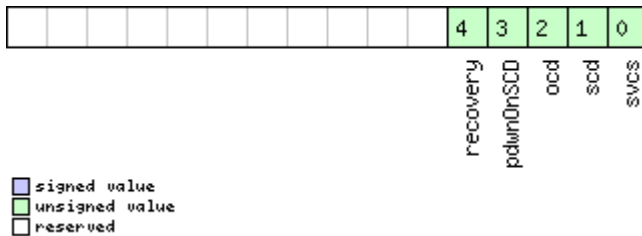

Name	Description
svcs	Enable Antenna Supply Voltage Control Signal
scd	Enable Short Circuit Detection
ocd	Enable Open Circuit Detection
pdwnOnSCD	Power Down Antenna supply if Short Circuit is detected. (only in combination with Bit 1)
recovery	Enable automatic recovery from short state

Bitfield pins

This graphic explains the bits of pins

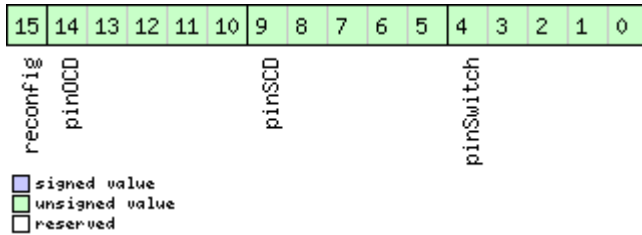

Name	Description
pinSwitch	PIO-Pin used for switching antenna supply
pinSCD	PIO-Pin used for detecting a short in the antenna supply
pinOCD	PIO-Pin used for detecting open/not connected antenna
reconfig	if set to one, and this command is sent to the receiver, the receiver will reconfigure the pins as specified.

31.11.2 UBX-CFG-CFG (0x06 0x09)

31.11.2.1 Clear, Save and Load configurations

Message	CFG-CFG					
Description	Clear, Save and Load configurations					
Firmware	Supported on: <ul style="list-style-type: none"> u-blox 8 / u-blox M8 from protocol version 15 up to version 23.01 					
Type	Command					
Comment	See Receiver Configuration for a detailed description on how Receiver Configuration should be used. The three masks are made up of individual bits, each bit indicating the sub-section of all configurations on which the corresponding action shall be carried out. The reserved bits in the masks must be set to '0'. For detailed information refer to the Organization of the Configuration Sections . Note that commands can be combined. The sequence of execution is Clear, Save, Load					
Message Structure	Header	Class	ID	Length (Bytes)	Payload	Checksum
	0xB5 0x62	0x06	0x09	(12) or (13)	see below	CK_A CK_B
Payload Contents:						
Byte Offset	Number Format	Scaling	Name	Unit	Description	
0	X4	-	clearMask	-	Mask with configuration sub-sections to clear (i. e. load default configurations to permanent configurations in non-volatile memory) (see graphic below)	
4	X4	-	saveMask	-	Mask with configuration sub-sections to save (i. e. save current configurations to non-volatile memory), see ID description of clearMask	
8	X4	-	loadMask	-	Mask with configuration sub-sections to load (i. e. load permanent configurations from non-volatile memory to current configurations), see ID description of clearMask	
Start of optional block						
12	X1	-	deviceMask	-	Mask which selects the memory devices for this command. (see graphic below)	

CFG-CFG continued

Byte Offset	Number Format	Scaling	Name	Unit	Description
End of optional block					

Bitfield clearMask

This graphic explains the bits of clearMask

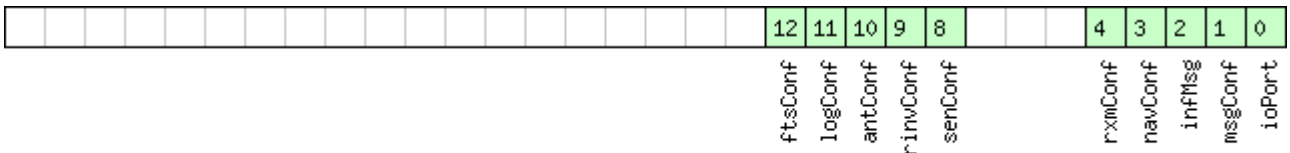

- signed value
- unsigned value
- reserved

Name	Description
ioPort	Communications port settings. Modifying this sub-section results in an IO system reset. Because of this undefined data may be output for a short period of time after receiving the message.
msgConf	Message configuration
infMsg	INF message configuration
navConf	Navigation configuration
rxmConf	Receiver Manager configuration
senConf	Sensor interface configuration (not supported in protocol versions less than 19)
rinvConf	Remote inventory configuration
antConf	Antenna configuration
logConf	Logging configuration
ftsConf	FTS configuration. Only applicable to the FTS product variant.

Bitfield deviceMask

This graphic explains the bits of deviceMask

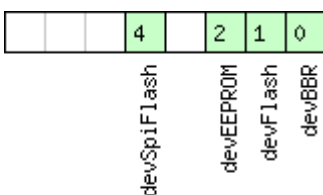

- signed value
- unsigned value
- reserved

Name	Description
devBBR	Battery backed RAM
devFlash	Flash
devEEPROM	EEPROM
devSpiFlash	SPI Flash

31.11.3 UBX-CFG-DAT (0x06 0x06)

31.11.3.1 Set User-defined Datum.

Message	CFG-DAT					
Description	Set User-defined Datum.					
Firmware	Supported on: <ul style="list-style-type: none"> u-blox 8 / u-blox M8 from protocol version 15 up to version 23.01 					
Type	Set					
Comment	For more information see the description of Geodetic Systems and Frames .					
Message Structure	Header	Class	ID	Length (Bytes)	Payload	Checksum
	0xB5 0x62	0x06	0x06	44	see below	CK_A CK_B
Payload Contents:						
Byte Offset	Number Format	Scaling	Name	Unit	Description	
0	R8	-	ma jA	m	Semi-major Axis (accepted range = 6,300,000.0 to 6,500,000.0 meters).	
8	R8	-	flat	-	1.0 / Flattening (accepted range is 0.0 to 500.0).	
16	R4	-	dX	m	X Axis shift at the origin (accepted range is +/- 5000.0 meters).	
20	R4	-	dY	m	Y Axis shift at the origin (accepted range is +/- 5000.0 meters).	
24	R4	-	dZ	m	Z Axis shift at the origin (accepted range is +/- 5000.0 meters).	
28	R4	-	rotX	s	Rotation about the X Axis (accepted range is +/- 20.0 milli-arc seconds).	
32	R4	-	rotY	s	Rotation about the Y Axis (accepted range is +/- 20.0 milli-arc seconds).	
36	R4	-	rotZ	s	Rotation about the Z Axis (accepted range is +/- 20.0 milli-arc seconds).	
40	R4	-	scale	ppm	Scale change (accepted range is 0.0 to 50.0 parts per million).	

31.11.3.2 The currently defined Datum

Message	CFG-DAT					
Description	The currently defined Datum					
Firmware	Supported on: <ul style="list-style-type: none"> u-blox 8 / u-blox M8 from protocol version 15 up to version 23.01 					
Type	Get					
Comment	Returns the parameters of the currently defined datum. If no user-defined datum has been set, this will default to WGS84.					
Message Structure	Header	Class	ID	Length (Bytes)	Payload	Checksum
	0xB5 0x62	0x06	0x06	52	see below	CK_A CK_B
Payload Contents:						
Byte Offset	Number Format	Scaling	Name	Unit	Description	

CFG-DAT continued

Byte Offset	Number Format	Scaling	Name	Unit	Description
0	U2	-	datumNum	-	Datum Number: 0 = WGS84, 0xFFFF = user-defined
2	CH[6]	-	datumName	-	ASCII String: WGS84 or USER
8	R8	-	ma jA	m	Semi-major Axis (accepted range = 6,300,000.0 to 6,500,000.0 meters).
16	R8	-	flat	-	1.0 / Flattening (accepted range is 0.0 to 500.0).
24	R4	-	dX	m	X Axis shift at the origin (accepted range is +/- 5000.0 meters).
28	R4	-	dY	m	Y Axis shift at the origin (accepted range is +/- 5000.0 meters).
32	R4	-	dZ	m	Z Axis shift at the origin (accepted range is +/- 5000.0 meters).
36	R4	-	rotX	s	Rotation about the X Axis (accepted range is +/- 20.0 milli-arc seconds).
40	R4	-	rotY	s	Rotation about the Y Axis (accepted range is +/- 20.0 milli-arc seconds).
44	R4	-	rotZ	s	Rotation about the Z Axis (accepted range is +/- 20.0 milli-arc seconds).
48	R4	-	scale	ppm	Scale change (accepted range is 0.0 to 50.0 parts per million).

31.11.4 UBX-CFG-DGNSS (0x06 0x70)
31.11.4.1 DGNSS configuration

Message	CFG-DGNSS					
Description	DGNSS configuration					
Firmware	Supported on: <ul style="list-style-type: none"> u-blox 8 / u-blox M8 from protocol version 20.01 up to version 23.01 (only with High Precision GNSS products) 					
Type	Get/Set					
Comment	This message allows the user to configure the DGNSS configuration of the receiver.					
Message Structure	Header	Class	ID	Length (Bytes)	Payload	Checksum
	0xB5 0x62	0x06	0x70	4	see below	CK_A CK_B
Payload Contents:						
Byte Offset	Number Format	Scaling	Name	Unit	Description	
0	U1	-	dgnssMode	-	Specifies differential mode: 2: RTK float: No attempts are made to fix ambiguities. 3: RTK fixed: Ambiguities are fixed whenever possible.	
1	U1[3]	-	reserved1	-	Reserved	

31.11.5 UBX-CFG-DOSC (0x06 0x61)

31.11.5.1 Disciplined oscillator configuration

Message		CFG-DOSC					
Description		Disciplined oscillator configuration					
Firmware		Supported on: <ul style="list-style-type: none"> u-blox 8 / u-blox M8 from protocol version 16 up to version 23.01 (only with Time & Frequency Sync products) 					
Type		Get/Set					
Comment		<p>This message allows the characteristics of the internal or external oscillator to be described to the receiver.</p> <p>The gainVco and gainUncertainty parameters are normally set using the calibration process initiated using UBX-TIM-VCOCAL.</p> <p>The behavior of the system can be badly affected by setting the wrong values, so customers are advised to only change these parameters with care.</p>					
Message Structure		Header	Class	ID	Length (Bytes)	Payload	Checksum
		0xB5 0x62	0x06	0x61	4 + 32*numOsc	see below	CK_A CK_B
Payload Contents:							
Byte Offset	Number Format	Scaling	Name	Unit	Description		
0	U1	-	version	-	Message version (0 for this version)		
1	U1	-	numOsc	-	Number of oscillators to configure (affects length of this message)		
2	U1[2]	-	reserved1	-	Reserved		
Start of repeated block (numOsc times)							
4 + 32*N	U1	-	oscId	-	Id of oscillator. 0 - internal oscillator 1 - external oscillator		
5 + 32*N	U1	-	reserved2	-	Reserved		
6 + 32*N	X2	-	flags	-	flags (see graphic below)		
8 + 32*N	U4	2 ⁻²	freq	Hz	Nominal frequency of source		
12 + 32*N	I4	-	phaseOffset	ps	Intended phase offset of the oscillator relative to the leading edge of the time pulse		
16 + 32*N	U4	2 ⁻⁸	withTemp	ppb	Oscillator stability limit over operating temperature range (must be > 0)		
20 + 32*N	U4	2 ⁻⁸	withAge	ppb/year	Oscillator stability with age (must be > 0)		
24 + 32*N	U2	-	timeToTemp	s	The minimum time that it could take for a temperature variation to move the oscillator frequency by 'withTemp' (must be > 0)		
26 + 32*N	U1[2]	-	reserved3	-	Reserved		
28 + 32*N	I4	2 ⁻¹⁶	gainVco	ppb/raw LSB	Oscillator control gain/slope; change of frequency per unit change in raw control change		
32 + 32*N	U1	2 ⁻⁸	gainUncertainty	-	Relative uncertainty (1 standard deviation) of oscillator control gain/slope		
33 + 32*N	U1[3]	-	reserved4	-	Reserved		

CFG-DOSC continued

Byte Offset	Number Format	Scaling	Name	Unit	Description
End of repeated block					

Bitfield flags

This graphic explains the bits of flags

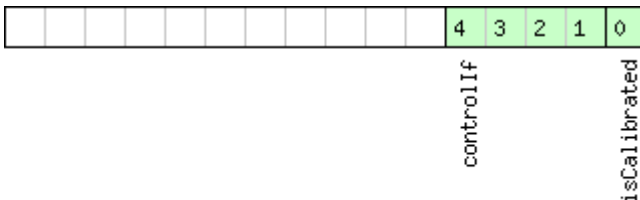

- signed value
- unsigned value
- reserved

Name	Description
isCalibrated	1 if the oscillator gain is calibrated, 0 if not
controlIf	Communication interface for oscillator control: 0: Custom DAC attached to receiver's I2C 1: Microchip MCP4726 (12 bit DAC) attached to receiver's I2C 2: TI DAC8571 (16 bit DAC) attached to receiver's I2C 13: 12 bit DAC attached to host 14: 14 bit DAC attached to host 15: 16 bit DAC attached to host Note that for DACs attached to the host, the host must monitor TIM-DOSC messages and pass the supplied raw values on to the DAC.

31.11.6 UBX-CFG-DYNSEED (0x06 0x85)

31.11.6.1 Programming the dynamic seed for the host interface signature

Message	CFG-DYNSEED					
Description	Programming the dynamic seed for the host interface signature					
Firmware	Supported on: <ul style="list-style-type: none"> u-blox 8 / u-blox M8 from protocol version 18 up to version 23.01 					
Type	Set					
Comment	The message can be used to program the dynamic seed for the host interface signature. If successfully configured, the message will answer with ACK, otherwise with NAK. Before the first programming, it is assumed that the dynamic seed is all '0'.					
Message Structure	Header	Class	ID	Length (Bytes)	Payload	Checksum
	0xB5 0x62	0x06	0x85	12	see below	CK_A CK_B
Payload Contents:						
Byte Offset	Number Format	Scaling	Name	Unit	Description	
0	U1	-	version	-	Message version (0x01 for this version)	
1	U1[3]	-	reserved1	-	Reserved	
4	U4	-	seedHi	-	high word of dynamic seed	
8	U4	-	seedLo	-	low word of dynamic seed	

31.11.7 UBX-CFG-ESRC (0x06 0x60)

31.11.7.1 External synchronization source configuration

Message		CFG-ESRC					
Description		External synchronization source configuration					
Firmware		Supported on: <ul style="list-style-type: none"> u-blox 8 / u-blox M8 from protocol version 16 up to version 23.01 (only with Time & Frequency Sync products) 					
Type		Get/Set					
Comment		External time or frequency source configuration. The stability of time and frequency sources is described using different fields, see sourceType field documentation.					
Message Structure		Header	Class	ID	Length (Bytes)	Payload	Checksum
		0xB5 0x62	0x06	0x60	4 + 36*numSources	see below	CK_A CK_B
Payload Contents:							
Byte Offset	Number Format	Scaling	Name	Unit	Description		
0	U1	-	version	-	Message version (0 for this version)		
1	U1	-	numSources	-	Number of sources (affects length of this message)		
2	U1[2]	-	reserved1	-	Reserved		
Start of repeated block (numSources times)							
4 + 36*N	U1	-	extInt	-	EXTINT index of this source (0 for EXTINT0 and 1 for EXTINT1)		
5 + 36*N	U1	-	sourceType	-	Source type: 0: none 1: frequency source; use withTemp, withAge, timeToTemp and maxDevLifeTime to describe the stability of the source 2: time source; use offset, offsetUncertainty and jitter fields to describe the stability of the source 3: feedback from external oscillator; stability data is taken from the external oscillator's configuration		
6 + 36*N	X2	-	flags	-	Flags (see graphic below)		
8 + 36*N	U4	2 ⁻²	freq	Hz	Nominal frequency of source		
12 + 36*N	U1[4]	-	reserved2	-	Reserved		
16 + 36*N	U4	2 ⁻⁸	withTemp	ppb	Oscillator stability limit over operating temperature range (must be > 0) Only used if sourceType is 1.		
20 + 36*N	U4	2 ⁻⁸	withAge	ppb/year	Oscillator stability with age (must be > 0) Only used if sourceType is 1.		
24 + 36*N	U2	-	timeToTemp	s	The minimum time that it could take for a temperature variation to move the oscillator frequency by 'withTemp' (must be > 0) Only used if sourceType is 1.		

CFG-ESRC continued

Byte Offset	Number Format	Scaling	Name	Unit	Description
26 + 36*N	U2	-	maxDevLifeTime	ppb	Maximum frequency deviation during lifetime (must be > 0) Only used if sourceType is 1.
28 + 36*N	I4	-	offset	ns	Phase offset of signal Only used if sourceType is 2.
32 + 36*N	U4	-	offsetUncertainty	ns	Uncertainty of phase offset (one standard deviation) Only used if sourceType is 2.
36 + 36*N	U4	-	jitter	ns/s	Phase jitter (must be > 0) Only used if sourceType is 2.
End of repeated block					

Bitfield flags

This graphic explains the bits of flags

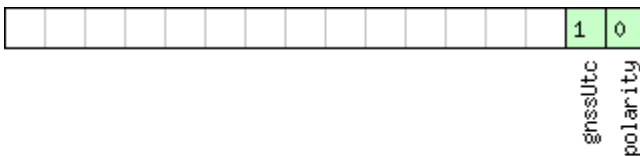

Name	Description
polarity	Polarity of signal: 0: leading edge is rising edge 1: leading edge is falling edge
gnssUtc	Time base of timing signal: 0: GNSS - as specified in CFG-TP5 (or GPS if CFG-TP5 indicates UTC) 1: UTC Only used if sourceType is 2.

31.11.8 UBX-CFG-FIXSEED (0x06 0x84)

31.11.8.1 Programming the fixed seed for host interface signature

Message	CFG-FIXSEED					
Description	Programming the fixed seed for host interface signature					
Firmware	Supported on: <ul style="list-style-type: none"> u-blox 8 / u-blox M8 from protocol version 18 up to version 23.01 					
Type	Set					
Comment	The message can be used to program the fixed seed for the host interface signature. Moreover it will configure the set of messages that will be signed (min. 1, max. 10). If the class ID of the message is 0 the configuration is ignored for that message. If successfully configured, the message will answer with ACK, otherwise with NAK. See the configuring the fixed seed and register messages description for feature details.					
Message Structure	Header	Class	ID	Length (Bytes)	Payload	Checksum
	0xB5 0x62	0x06	0x84	12 + 2*length	see below	CK_A CK_B

Payload Contents:					
Byte Offset	Number Format	Scaling	Name	Unit	Description
0	U1	-	version	-	Message version (0x02 for this version)
1	U1	-	length	-	Number of registered messages (min. 1, max. 10)
2	U1[2]	-	reserved1	-	Reserved
4	U4	-	seedHi	-	high word of fixed seed
8	U4	-	seedLo	-	low word of fixed seed
Start of repeated block (length times)					
12 + 2*N	U1	-	classId	-	Class ID on the message
13 + 2*N	U1	-	msgId	-	Message ID on the message
End of repeated block					

31.11.9 UBX-CFG-GEOFENCE (0x06 0x69)

31.11.9.1 Geofencing configuration

Message	CFG-GEOFENCE					
Description	Geofencing configuration					
Firmware	Supported on: <ul style="list-style-type: none"> u-blox 8 / u-blox M8 from protocol version 18 up to version 23.01 					
Type	Get/Set					
Comment	<p>Gets or sets the geofencing configuration See the Geofencing description for feature details.</p> <p>If the receiver is sent a valid new configuration, it will respond with a UBX-ACK-ACK message and immediately change to the new configuration. Otherwise the receiver will reject the request, by issuing a UBX-ACK-NAK and continuing operation with the previous configuration.</p> <p>Note that the acknowledge message does not indicate whether the PIO configuration has been successfully applied (pin assigned), it only indicates the successful configuration of the feature. The configured PIO must be previously unoccupied for successful assignment.</p>					
Message Structure	Header	Class	ID	Length (Bytes)	Payload	Checksum
	0xB5 0x62	0x06	0x69	8 + 12*numFences	see below	CK_A CK_B
Payload Contents:						
Byte Offset	Number Format	Scaling	Name	Unit	Description	
0	U1	-	version	-	Message version (=0x00 for this version)	
1	U1	-	numFences	-	Number of geofences contained in this message. Note that the receiver can only store a limited number of geofences (currently 4).	
2	U1	-	confLvl	-	Required confidence level for state evaluation. This value times the position's standard deviation (sigma) defines the confidence band. 0=no confidence required, 1=68%, 2=95%, 3=99.7% etc.	
3	U1[1]	-	reserved1	-	Reserved	

CFG-GEOFENCE continued

Byte Offset	Number Format	Scaling	Name	Unit	Description
4	U1	-	pioEnabled	-	1 = Enable PIO combined fence state output, 0 = disable
5	U1	-	pinPolarity	-	PIO pin polarity. 0 = Low means inside, 1 = Low means outside. Unknown state is always high.
6	U1	-	pin	-	PIO pin number
7	U1[1]	-	reserved2	-	Reserved
<i>Start of repeated block (numFences times)</i>					
8 + 12*N	I4	1e-7	lat	deg	Latitude of the geofence circle center
12 + 12*N	I4	1e-7	lon	deg	Longitude of the geofence circle center
16 + 12*N	U4	1e-2	radius	m	Radius of the geofence circle
<i>End of repeated block</i>					

31.11.10 UBX-CFG-GNSS (0x06 0x3E)
31.11.10.1 GNSS system configuration

Message	CFG-GNSS				
Description	GNSS system configuration				
Firmware	Supported on: <ul style="list-style-type: none"> u-blox 8 / u-blox M8 from protocol version 15 up to version 23.01 				
Type	Get/Set				
Comment	<p>Gets or sets the GNSS system channel sharing configuration.</p> <p>If the receiver is sent a valid new configuration, it will respond with a UBX-ACK-ACK message and immediately change to the new configuration. Otherwise the receiver will reject the request, by issuing a UBX-ACK-NAK and continuing operation with the previous configuration.</p> <p>Configuration requirements:</p> <ul style="list-style-type: none"> It is necessary for at least one major GNSS to be enabled, after applying the new configuration to the current one. It is also required that at least 4 tracking channels are available to each enabled major GNSS, i.e. <code>maxTrkCh</code> must have a minimum value of 4 for each enabled major GNSS. The number of tracking channels in use must not exceed the number of tracking channels available in hardware, and the sum of all reserved tracking channels needs to be less than or equal to the number of tracking channels in use. <p>Notes:</p> <ul style="list-style-type: none"> To avoid cross-correlation issues, it is recommended that GPS and QZSS are always both enabled or both disabled. Polling this message returns the configuration of all supported GNSS, whether enabled or not; it may also include GNSS unsupported by the particular product, but in such cases the enable flag will always be unset. See section GNSS Configuration for a discussion of the use of this message and section Satellite Numbering for a description of the GNSS IDs available. Configuration specific to the GNSS system can be done via other messages (e.g. UBX-CFG-SBAS). 				
	Header	Class	ID	Length (Bytes)	Payload Checksum

Message Structure		0xB5 0x62	0x06	0x3E	4 + 8*numConfigBlocks	see below	CK_A CK_B
Payload Contents:							
Byte Offset	Number Format	Scaling	Name	Unit	Description		
0	U1	-	msgVer	-	Message version (=0 for this version)		
1	U1	-	numTrkChHw	-	Number of tracking channels available in hardware (read only)		
2	U1	-	numTrkChUse	-	(Read only in protocol versions greater than 23) Number of tracking channels to use. Must be > 0, <= numTrkChHw. If 0xFF, then number of tracking channels to use will be set to numTrkChHw.		
3	U1	-	numConfigBlocks	-	Number of configuration blocks following		
Start of repeated block (numConfigBlocks times)							
4 + 8*N	U1	-	gnssId	-	System identifier (see Satellite Numbering)		
5 + 8*N	U1	-	resTrkCh	-	(Read only in protocol versions greater than 23) Number of reserved (minimum) tracking channels for this system.		
6 + 8*N	U1	-	maxTrkCh	-	(Read only in protocol versions greater than 23) Maximum number of tracking channels used for this system. Must be > 0, >= resTrkChn, <= numTrkChUse and <= maximum number of tracking channels supported for this system.		
7 + 8*N	U1	-	reserved1	-	Reserved		
8 + 8*N	X4	-	flags	-	bitfield of flags. At least one signal must be configured in every enabled system. (see graphic below)		
End of repeated block							

Bitfield flags

This graphic explains the bits of flags

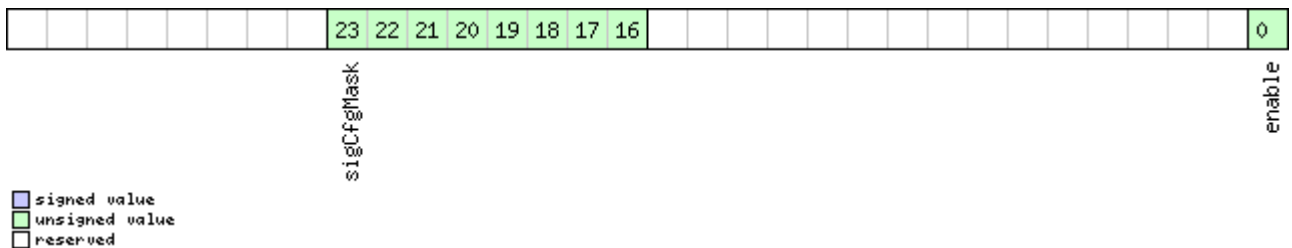

- signed value
- unsigned value
- reserved

Name	Description
enable	Enable this system

Bitfield flags Description continued

Name	Description
sigCfgMask	Signal configuration mask When gnssId is 0 (GPS) * 0x01 = GPS L1C/A When gnssId is 1 (SBAS) * 0x01 = SBAS L1C/A When gnssId is 2 (Galileo) * 0x01 = Galileo E1OS (not supported in protocol versions less than 18) When gnssId is 3 (BeiDou) * 0x01 = BeiDou B1I When gnssId is 4 (IMES) * 0x01 = IMES L1 When gnssId is 5 (QZSS) * 0x01 = QZSS L1C/A * 0x04 = QZSS L1SAIF When gnssId is 6 (GLONASS) * 0x01 = GLONASS L1OF

31.11.11 UBX-CFG-HNR (0x06 0x5C)
31.11.11.1 High Navigation Rate Settings

Message	CFG-HNR					
Description	High Navigation Rate Settings					
Firmware	Supported on: <ul style="list-style-type: none"> • u-blox 8 / u-blox M8 from protocol version 15.01 up to version 17 (only with ADR products) • u-blox 8 / u-blox M8 from protocol version 19 up to version 23.01 (only with ADR or UDR products) 					
Type	Get/Set					
Comment	The u-blox receivers support high rates of navigation update up to 30 Hz. The navigation solution output (NAV-HNR) will not be aligned to the top of a second. <ul style="list-style-type: none"> • The update rate has a direct influence on the power consumption. The more fixes that are required, the more CPU power and communication resources are required. • For most applications a 1 Hz update rate would be sufficient. 					
Message Structure	Header	Class	ID	Length (Bytes)	Payload	Checksum
	0xB5 0x62	0x06	0x5C	4	see below	CK_A CK_B
Payload Contents:						
Byte Offset	Number Format	Scaling	Name	Unit	Description	
0	U1	-	highNavRate	Hz	Rate of navigation solution output	
1	U1[3]	-	reserved1	-	Reserved	

31.11.12 UBX-CFG-INF (0x06 0x02)

31.11.12.1 Poll configuration for one protocol

Message	CFG-INF					
Description	Poll configuration for one protocol					
Firmware	Supported on: <ul style="list-style-type: none"> u-blox 8 / u-blox M8 from protocol version 15 up to version 23.01 					
Type	Poll Request					
Comment	-					
Message Structure	Header	Class	ID	Length (Bytes)	Payload	Checksum
	0xB5 0x62	0x06	0x02	1	see below	CK_A CK_B
Payload Contents:						
Byte Offset	Number Format	Scaling	Name	Unit	Description	
0	U1	-	protocolID	-	Protocol Identifier, identifying the output protocol for this Poll Request. The following are valid Protocol Identifiers: 0: UBX Protocol 1: NMEA Protocol 2-255: Reserved	

31.11.12.2 Information message configuration

Message	CFG-INF					
Description	Information message configuration					
Firmware	Supported on: <ul style="list-style-type: none"> u-blox 8 / u-blox M8 from protocol version 15 up to version 23.01 					
Type	Get/Set					
Comment	The value of infMsgMask[x] below are that each bit represents one of the INF class messages (Bit 0 for ERROR, Bit 1 for WARNING and so on.). For a complete list, see the Message Class INF . Several configurations can be concatenated to one input message. In this case the payload length can be a multiple of the normal length. Output messages from the module contain only one configuration unit. Note that I/O Ports 1 and 2 correspond to serial ports 1 and 2. I/O port 0 is DDC. I/O port 3 is USB. I/O port 4 is SPI. I/O port 5 is reserved for future use.					
Message Structure	Header	Class	ID	Length (Bytes)	Payload	Checksum
	0xB5 0x62	0x06	0x02	0 + 10*N	see below	CK_A CK_B
Payload Contents:						
Byte Offset	Number Format	Scaling	Name	Unit	Description	
Start of repeated block (N times)						
N*10	U1	-	protocolID	-	Protocol Identifier, identifying for which protocol the configuration is set/get. The following are valid Protocol Identifiers: 0: UBX Protocol 1: NMEA Protocol 2-255: Reserved	

CFG-INF continued

Byte Offset	Number Format	Scaling	Name	Unit	Description
1 + 10*N	U1[3]	-	reserved1	-	Reserved
4 + 10*N	X1[6]	-	infMsgMask	-	A bit mask, saying which information messages are enabled on each I/O port (see graphic below)
End of repeated block					

Bitfield infMsgMask

This graphic explains the bits of infMsgMask

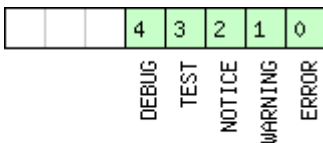

■ signed value
■ unsigned value
■ reserved

Name	Description
ERROR	enable ERROR
WARNING	enable WARNING
NOTICE	enable NOTICE
TEST	enable TEST
DEBUG	enable DEBUG

31.11.13 UBX-CFG-ITFM (0x06 0x39)

31.11.13.1 Jamming/Interference Monitor configuration

Message	CFG-ITFM					
Description	Jamming/Interference Monitor configuration					
Firmware	Supported on: <ul style="list-style-type: none"> u-blox 8 / u-blox M8 from protocol version 15 up to version 23.01 					
Type	Get/Set					
Comment	Configuration of Jamming/Interference monitor.					
Message Structure	Header	Class	ID	Length (Bytes)	Payload	Checksum
	0xB5 0x62	0x06	0x39	8	see below	CK_A CK_B
Payload Contents:						
Byte Offset	Number Format	Scaling	Name	Unit	Description	
0	X4	-	config	-	interference config word. (see graphic below)	
4	X4	-	config2	-	extra settings for jamming/interference monitor (see graphic below)	

Bitfield config

This graphic explains the bits of `config`

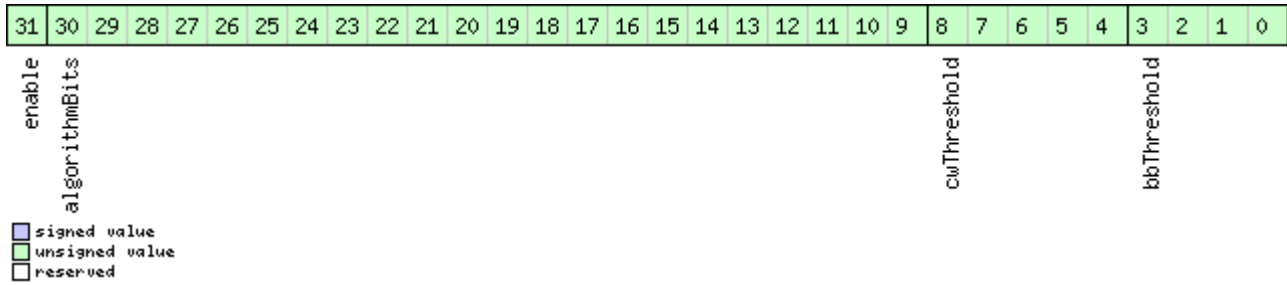

Name	Description
bbThreshold	Broadband jamming detection threshold (unit = dB)
cwThreshold	CW jamming detection threshold (unit = dB)
algorithmBits	reserved algorithm settings - should be set to 0x16B156 in hex for correct settings
enable	enable interference detection

Bitfield config2

This graphic explains the bits of `config2`

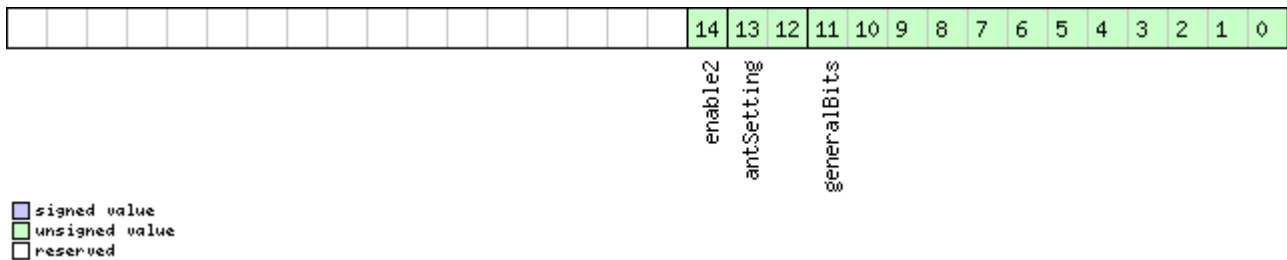

Name	Description
generalBits	general settings - should be set to 0x31E in hex for correct setting
antSetting	antennaSetting, 0=unknown, 1=passive, 2=active
enable2	Set to 1 to scan auxiliary bands (u-blox 8 / u-blox M8 only, otherwise ignored)

31.11.14 UBX-CFG-LOGFILTER (0x06 0x47)

31.11.14.1 Data Logger Configuration

Message	CFG-LOGFILTER
Description	Data Logger Configuration
Firmware	Supported on: <ul style="list-style-type: none"> u-blox 8 / u-blox M8 from protocol version 15 up to version 23.01
Type	Get/Set
Comment	<p>This message can be used to configure the data logger, i.e. to enable/disable the log recording and to get/set the position entry filter settings.</p> <p>Position entries can be filtered based on time difference, position difference or current speed thresholds. Position and speed filtering also have a minimum time interval. A position is logged if any of the thresholds are exceeded. If a threshold is set to zero it is ignored. The maximum rate of position logging is 1Hz.</p> <p>The filter settings will be configured to the provided values only if the 'applyAllFilterSettings' flag is set. This allows the recording to be enabled/disabled independently of configuring the filter settings.</p>

		It is supported to configure the data logger in the absence of a logging file. By doing so, once the logging file is created, the data logger configuration will take effect immediately and logging recording and filtering will activate according to the configuration.					
Message Structure		Header	Class	ID	Length (Bytes)	Payload	Checksum
		0xB5 0x62	0x06	0x47	12	see below	CK_A CK_B
Payload Contents:							
Byte Offset	Number Format	Scaling	Name	Unit	Description		
0	U1	-	version	-	The version of this message. Set to 1		
1	X1	-	flags	-	Flags (see graphic below)		
2	U2	-	minInterval	s	Minimum time interval between logged positions (0 = not set). This is only applied in combination with the speed and/or position thresholds. If both minInterval and timeThreshold are set, minInterval must be less than or equal to timeThreshold.		
4	U2	-	timeThreshold	s	If the time difference is greater than the threshold then the position is logged (0 = not set).		
6	U2	-	speedThreshold	m/s	If the current speed is greater than the threshold then the position is logged (0 = not set). minInterval also applies		
8	U4	-	positionThreshold	m	If the 3D position difference is greater than the threshold then the position is logged (0 = not set). minInterval also applies		

Bitfield flags

This graphic explains the bits of flags

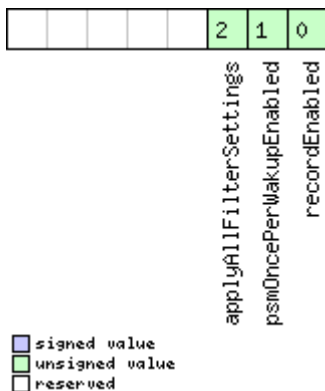

Name	Description
recordEnabled	1 = enable recording, 0 = disable recording
psmOncePerWakeupEnabled	1 = enable recording only one single position per PSM on/off mode wake-up period, 0 = disable once per wake-up
applyAllFilterSettings	1 = apply all filter settings, 0 = only apply recordEnabled

31.11.15 UBX-CFG-MSG (0x06 0x01)

31.11.15.1 Poll a message configuration

Message		CFG-MSG					
Description		Poll a message configuration					
Firmware		Supported on: <ul style="list-style-type: none"> u-blox 8 / u-blox M8 from protocol version 15 up to version 23.01 					
Type		Poll Request					
Comment		-					
Message Structure		Header	Class	ID	Length (Bytes)	Payload	Checksum
		0xB5 0x62	0x06	0x01	2	see below	CK_A CK_B
Payload Contents:							
Byte Offset	Number Format	Scaling	Name	Unit	Description		
0	U1	-	msgClass	-	Message Class		
1	U1	-	msgID	-	Message Identifier		

31.11.15.2 Set Message Rate(s)

Message		CFG-MSG					
Description		Set Message Rate(s)					
Firmware		Supported on: <ul style="list-style-type: none"> u-blox 8 / u-blox M8 from protocol version 15 up to version 23.01 					
Type		Get/Set					
Comment		Set/Get message rate configuration (s) to/from the receiver. See also section How to change between protocols . <ul style="list-style-type: none"> Send rate is relative to the event a message is registered on. For example, if the rate of a navigation message is set to 2, the message is sent every second navigation solution. For configuring NMEA messages, the section NMEA Messages Overview describes Class and Identifier numbers used. 					
Message Structure		Header	Class	ID	Length (Bytes)	Payload	Checksum
		0xB5 0x62	0x06	0x01	8	see below	CK_A CK_B
Payload Contents:							
Byte Offset	Number Format	Scaling	Name	Unit	Description		
0	U1	-	msgClass	-	Message Class		
1	U1	-	msgID	-	Message Identifier		
2	U1[6]	-	rate	-	Send rate on I/O Port (6 Ports)		

31.11.15.3 Set Message Rate

Message	CFG-MSG					
Description	Set Message Rate					
Firmware	Supported on: <ul style="list-style-type: none"> u-blox 8 / u-blox M8 from protocol version 15 up to version 23.01 					
Type	Get/Set					
Comment	Set message rate configuration for the current port. See also section How to change between protocols .					
Message Structure	Header	Class	ID	Length (Bytes)	Payload	Checksum
	0xB5 0x62	0x06	0x01	3	see below	CK_A CK_B
Payload Contents:						
Byte Offset	Number Format	Scaling	Name	Unit	Description	
0	U1	-	msgClass	-	Message Class	
1	U1	-	msgID	-	Message Identifier	
2	U1	-	rate	-	Send rate on current Port	

31.11.16 UBX-CFG-NAV5 (0x06 0x24)

31.11.16.1 Navigation Engine Settings

Message	CFG-NAV5					
Description	Navigation Engine Settings					
Firmware	Supported on: <ul style="list-style-type: none"> u-blox 8 / u-blox M8 from protocol version 15 up to version 23.01 					
Type	Get/Set					
Comment	See the Navigation Configuration Settings Description for a detailed description of how these settings affect receiver operation.					
Message Structure	Header	Class	ID	Length (Bytes)	Payload	Checksum
	0xB5 0x62	0x06	0x24	36	see below	CK_A CK_B
Payload Contents:						
Byte Offset	Number Format	Scaling	Name	Unit	Description	
0	X2	-	mask	-	Parameters Bitmask. Only the masked parameters will be applied. (see graphic below)	
2	U1	-	dynModel	-	Dynamic platform model: 0: portable 2: stationary 3: pedestrian 4: automotive 5: sea 6: airborne with <1g acceleration 7: airborne with <2g acceleration 8: airborne with <4g acceleration 9: wrist worn watch (not supported in protocol versions less than 18)	

CFG-NAV5 continued

Byte Offset	Number Format	Scaling	Name	Unit	Description
3	U1	-	fixMode	-	Position Fixing Mode: 1: 2D only 2: 3D only 3: auto 2D/3D
4	I4	0.01	fixedAlt	m	Fixed altitude (mean sea level) for 2D fix mode.
8	U4	0.0001	fixedAltVar	m ²	Fixed altitude variance for 2D mode.
12	I1	-	minElev	deg	Minimum Elevation for a GNSS satellite to be used in NAV
13	U1	-	drLimit	s	Reserved
14	U2	0.1	pDop	-	Position DOP Mask to use
16	U2	0.1	tDop	-	Time DOP Mask to use
18	U2	-	pAcc	m	Position Accuracy Mask
20	U2	-	tAcc	m	Time Accuracy Mask
22	U1	-	staticHoldThresh	cm/s	Static hold threshold
23	U1	-	dgnssTimeout	s	DGNSS timeout
24	U1	-	cnoThreshNumSVs	-	Number of satellites required to have C/N0 above cnoThresh for a fix to be attempted
25	U1	-	cnoThresh	dBHz	C/N0 threshold for deciding whether to attempt a fix
26	U1[2]	-	reserved1	-	Reserved
28	U2	-	staticHoldMaxDist	m	Static hold distance threshold (before quitting static hold)
30	U1	-	utcStandard	-	UTC standard to be used: 0: Automatic; receiver selects based on GNSS configuration (see GNSS time bases). 3: UTC as operated by the U.S. Naval Observatory (USNO); derived from GPS time 6: UTC as operated by the former Soviet Union; derived from GLONASS time 7: UTC as operated by the National Time Service Center, China; derived from BeiDou time (not supported in protocol versions less than 16).
31	U1[5]	-	reserved2	-	Reserved

Bitfield mask

This graphic explains the bits of mask

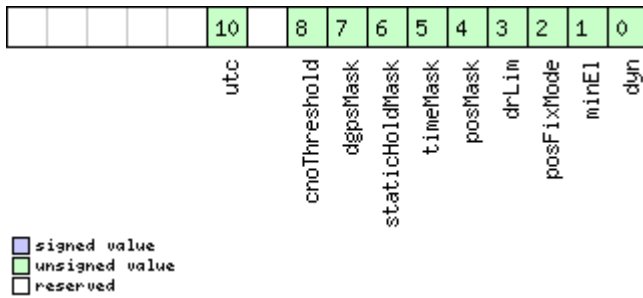

Name	Description
dyn	Apply dynamic model settings
minE1	Apply minimum elevation settings
posFixMode	Apply fix mode settings
drLim	Reserved
posMask	Apply position mask settings
timeMask	Apply time mask settings
staticHoldMask	Apply static hold settings
dgpsMask	Apply DGPS settings.
cnoThreshold	Apply CNO threshold settings (cnoThresh, cnoThreshNumSVs).
utc	Apply UTC settings. (not supported in protocol versions less than 16).

31.11.17 UBX-CFG-NAVX5 (0x06 0x23)

31.11.17.1 Navigation Engine Expert Settings

Message	CFG-NAVX5					
Description	Navigation Engine Expert Settings					
Firmware	Supported on: <ul style="list-style-type: none"> u-blox 8 / u-blox M8 from protocol version 15 up to version 17 					
Type	Get/Set					
Comment	-					
Message Structure	Header	Class	ID	Length (Bytes)	Payload	Checksum
	0xB5 0x62	0x06	0x23	40	see below	CK_A CK_B
Payload Contents:						
Byte Offset	Number Format	Scaling	Name	Unit	Description	
0	U2	-	version	-	Message version (0 for this version)	
2	X2	-	mask1	-	First parameters bitmask. Only the flagged parameters will be applied, unused bits must be set to 0. (see graphic below)	
4	X4	-	mask2	-	Second parameters bitmask. Only the flagged parameters will be applied, unused bits must be set to 0. (see graphic below)	
8	U1[2]	-	reserved1	-	Reserved	
10	U1	-	minSVs	#SVs	Minimum number of satellites for navigation	
11	U1	-	maxSVs	#SVs	Maximum number of satellites for navigation	

CFG-NAVX5 continued

Byte Offset	Number Format	Scaling	Name	Unit	Description
12	U1	-	minCNO	dBHz	Minimum satellite signal level for navigation
13	U1	-	reserved2	-	Reserved
14	U1	-	iniFix3D	-	1 = initial fix must be 3D
15	U1[2]	-	reserved3	-	Reserved
17	U1	-	ackAiding	-	1 = issue acknowledgements for assistance message input
18	U2	-	wknRollover	-	GPS week rollover number; GPS week numbers will be set correctly from this week up to 1024 weeks after this week. Setting this to 0 reverts to firmware default.
20	U1[6]	-	reserved4	-	Reserved
26	U1	-	usePPP	-	1 = use Precise Point Positioning (only available with the PPP product variant)
27	U1	-	aopCfg	-	AssistNow Autonomous configuration (see graphic below)
28	U1[2]	-	reserved5	-	Reserved
30	U2	-	aopOrbMaxErr	m	Maximum acceptable (modeled) AssistNow Autonomous orbit error (valid range = 5..1000, or 0 = reset to firmware default)
32	U1[4]	-	reserved6	-	Reserved
36	U1[3]	-	reserved7	-	Reserved
39	U1	-	useAdr	-	Only supported on certain products Enable/disable ADR sensor fusion (if 0: sensor fusion is disabled - if 1: sensor fusion is enabled).

Bitfield mask1

This graphic explains the bits of mask1

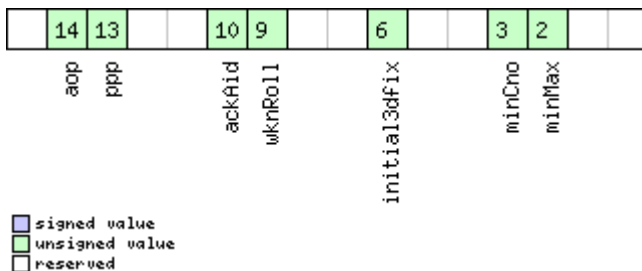

Name	Description
minMax	1 = apply min/max SVs settings
minCno	1 = apply minimum C/N0 setting
initial3dfix	1 = apply initial 3D fix settings
wknRoll	1 = apply GPS weeknumber rollover settings
ackAid	1 = apply assistance acknowledgement settings
ppp	1 = apply usePPP flag
aop	1 = apply aopCfg (useAOP flag) and aopOrbMaxErr settings (AssistNow Autonomous)

Bitfield mask2

This graphic explains the bits of mask2

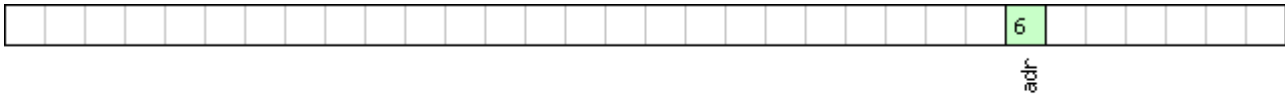

signed value
 unsigned value
 reserved

Name	Description
adr	Apply ADR sensor fusion on/off setting (useAdr flag)

Bitfield aopCfg

This graphic explains the bits of aopCfg

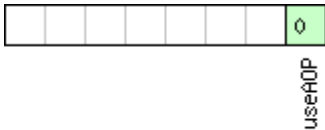

signed value
 unsigned value
 reserved

Name	Description
useAOP	1 = enable AssistNow Autonomous

31.11.17.2 Navigation Engine Expert Settings

Message	CFG-NAVX5					
Description	Navigation Engine Expert Settings					
Firmware	Supported on: <ul style="list-style-type: none"> u-blox 8 / u-blox M8 from protocol version 18 up to version 23.01 					
Type	Get/Set					
Comment	-					
Message Structure	Header	Class	ID	Length (Bytes)	Payload	Checksum
	0xB5 0x62	0x06	0x23	40	see below	CK_A CK_B

Payload Contents:

Byte Offset	Number Format	Scaling	Name	Unit	Description
0	U2	-	version	-	Message version (2 for this version)
2	X2	-	mask1	-	First parameters bitmask. Only the flagged parameters will be applied, unused bits must be set to 0. (see graphic below)
4	X4	-	mask2	-	Second parameters bitmask. Only the flagged parameters will be applied, unused bits must be set to 0. (see graphic below)
8	U1[2]	-	reserved1	-	Reserved
10	U1	-	minSVs	#SVs	Minimum number of satellites for navigation
11	U1	-	maxSVs	#SVs	Maximum number of satellites for navigation
12	U1	-	minCNO	dBHz	Minimum satellite signal level for navigation
13	U1	-	reserved2	-	Reserved
14	U1	-	iniFix3D	-	1 = initial fix must be 3D
15	U1[2]	-	reserved3	-	Reserved

CFG-NAVX5 continued

Byte Offset	Number Format	Scaling	Name	Unit	Description
17	U1	-	ackAiding	-	1 = issue acknowledgements for assistance message input
18	U2	-	wknRollover	-	GPS week rollover number; GPS week numbers will be set correctly from this week up to 1024 weeks after this week. Setting this to 0 reverts to firmware default.
20	U1	-	sigAttenCompMode	dBHz	<i>Only supported on certain products</i> Permanently attenuated signal compensation (0 = disabled, 255 = automatic, 1..63 = maximum expected C/N0 value)
21	U1	-	reserved4	-	Reserved
22	U1[2]	-	reserved5	-	Reserved
24	U1[2]	-	reserved6	-	Reserved
26	U1	-	usePPP	-	1 = use Precise Point Positioning (only available with the PPP product variant)
27	U1	-	aopCfg	-	<i>AssistNow Autonomous</i> configuration (see graphic below)
28	U1[2]	-	reserved7	-	Reserved
30	U2	-	aopOrbMaxErr	m	Maximum acceptable (modeled) <i>AssistNow Autonomous</i> orbit error (valid range = 5..1000, or 0 = reset to firmware default)
32	U1[4]	-	reserved8	-	Reserved
36	U1[3]	-	reserved9	-	Reserved
39	U1	-	useAdr	-	<i>Only supported on certain products</i> Enable/disable ADR/UDR sensor fusion (if 0: sensor fusion is disabled - if 1: sensor fusion is enabled).

Bitfield mask1

This graphic explains the bits of mask1

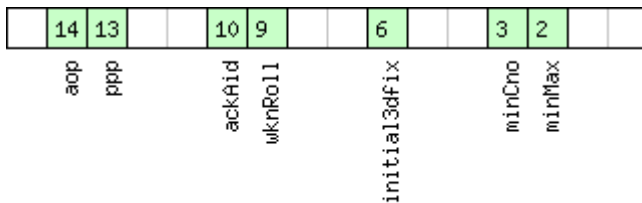

- signed value
- unsigned value
- reserved

Name	Description
minMax	1 = apply min/max SVs settings
minCno	1 = apply minimum C/N0 setting
initial3dfix	1 = apply initial 3D fix settings
wknRoll	1 = apply GPS weeknumber rollover settings
ackAid	1 = apply assistance acknowledgement settings

Bitfield mask1 Description continued

Name	Description
ppp	1 = apply usePPP flag
aop	1 = apply aopCfg (useAOP flag) and aopOrbMaxErr settings (AssistNow Autonomous)

Bitfield mask2

This graphic explains the bits of mask2

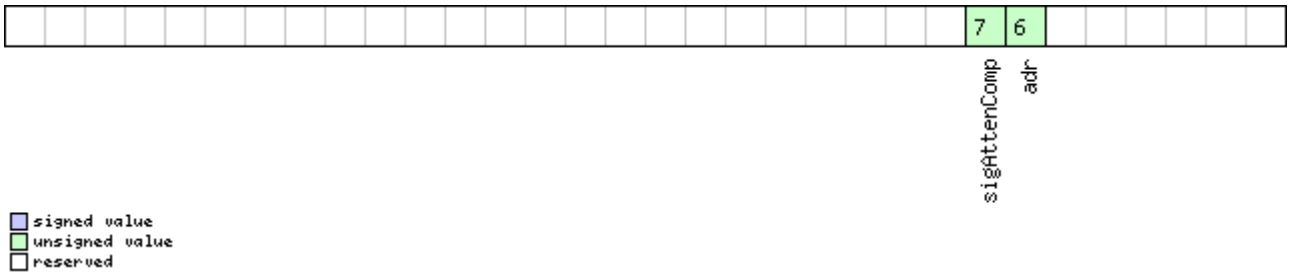

Name	Description
adr	Apply ADR/UDR sensor fusion on/off setting (useAdr flag)
sigAttenComp	Only supported on certain products Apply signal attenuation compensation feature settings

Bitfield aopCfg

This graphic explains the bits of aopCfg

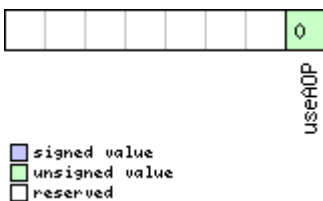

Name	Description
useAOP	1 = enable AssistNow Autonomous

31.11.18 UBX-CFG-NMEA (0x06 0x17)

31.11.18.1 NMEA protocol configuration (deprecated)

Message	CFG-NMEA					
Description	NMEA protocol configuration (deprecated)					
Firmware	Supported on: <ul style="list-style-type: none"> u-blox 8 / u-blox M8 from protocol version 15 up to version 23.01 					
Type	Get/Set					
Comment	<p>This message version is provided for backwards compatibility only. Use the last version listed below instead (its fields are backwards compatible with this version, it just has extra fields defined).</p> <p>Set/Get the NMEA protocol configuration. See section NMEA Protocol Configuration for a detailed description of the configuration effects on NMEA output.</p>					
Message Structure	Header	Class	ID	Length (Bytes)	Payload	Checksum
	0xB5 0x62	0x06	0x17	4	see below	CK_A CK_B
Payload Contents:						

CFG-NMEA continued

Byte Offset	Number Format	Scaling	Name	Unit	Description
0	X1	-	filter	-	filter flags (see graphic below)
1	U1	-	nmeaVersion	-	0x23: NMEA version 2.3 0x21: NMEA version 2.1
2	U1	-	numSV	-	Maximum Number of SVs to report per TalkerId. 0: unlimited 8: 8 SVs 12: 12 SVs 16: 16 SVs
3	X1	-	flags	-	flags (see graphic below)

Bitfield filter

This graphic explains the bits of filter

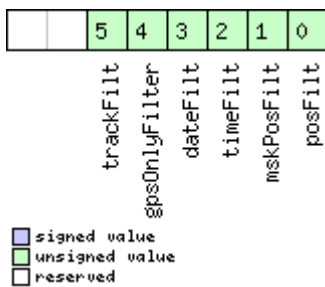

Name	Description
posFilt	Enable position output for failed or invalid fixes
mskPosFilt	Enable position output for invalid fixes
timeFilt	Enable time output for invalid times
dateFilt	Enable date output for invalid dates
gpsOnlyFilter	Restrict output to GPS satellites only
trackFilt	Enable COG output even if COG is frozen

Bitfield flags

This graphic explains the bits of flags

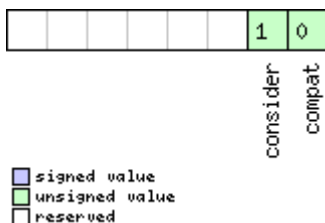

Name	Description
compat	enable compatibility mode. This might be needed for certain applications when customer's NMEA parser expects a fixed number of digits in position coordinates
consider	enable considering mode.

31.11.18.2 NMEA protocol configuration V0 (deprecated)

Message		CFG-NMEA					
Description		NMEA protocol configuration V0 (deprecated)					
Firmware		Supported on: <ul style="list-style-type: none"> • u-blox 8 / u-blox M8 from protocol version 15 up to version 23.01 					
Type		Get/Set					
Comment		<p>This message version is provided for backwards compatibility only. Use the last version listed below instead (its fields are backwards compatible with this version, it just has extra fields defined).</p> <p>Set/Get the NMEA protocol configuration. See section NMEA Protocol Configuration for a detailed description of the configuration effects on NMEA output.</p>					
Message Structure		Header	Class	ID	Length (Bytes)	Payload	Checksum
		0xB5 0x62	0x06	0x17	12	see below	CK_A CK_B
Payload Contents:							
Byte Offset	Number Format	Scaling	Name	Unit	Description		
0	X1	-	filter	-	filter flags (see graphic below)		
1	U1	-	nmeaVersion	-	0x23: NMEA version 2.3 0x21: NMEA version 2.1		
2	U1	-	numSV	-	Maximum Number of SVs to report per TalkerId. 0: unlimited 8: 8 SVs 12: 12 SVs 16: 16 SVs		
3	X1	-	flags	-	flags (see graphic below)		
4	X4	-	gnssToFilter	-	Filters out satellites based on their GNSS. If a bitfield is enabled, the corresponding satellites will be not output. (see graphic below)		
8	U1	-	svNumbering	-	Configures the display of satellites that do not have an NMEA-defined value. Note: this does not apply to satellites with an unknown ID. 0: Strict - Satellites are not output 1: Extended - Use proprietary numbering (see Satellite numbering)		

CFG-NMEA continued

Byte Offset	Number Format	Scaling	Name	Unit	Description
9	U1	-	mainTalkerId	-	By default the main Talker ID (i.e. the Talker ID used for all messages other than GSV) is determined by the GNSS assignment of the receiver's channels (see UBX-CFG-GNSS). This field enables the main Talker ID to be overridden. 0: Main Talker ID is not overridden 1: Set main Talker ID to 'GP' 2: Set main Talker ID to 'GL' 3: Set main Talker ID to 'GN' 4: Set main Talker ID to 'GA' 5: Set main Talker ID to 'GB'
10	U1	-	gsvTalkerId	-	By default the Talker ID for GSV messages is GNSS specific (as defined by NMEA). This field enables the GSV Talker ID to be overridden. 0: Use GNSS specific Talker ID (as defined by NMEA) 1: Use the main Talker ID
11	U1	-	version	-	Message version (set to 0 for this version)

Bitfield filter

This graphic explains the bits of filter

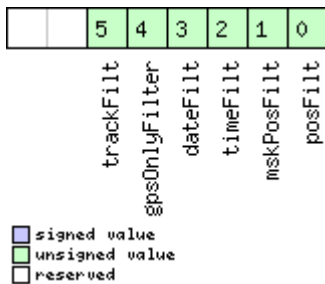

Name	Description
posFilt	Enable position output for failed or invalid fixes
mskPosFilt	Enable position output for invalid fixes
timeFilt	Enable time output for invalid times
dateFilt	Enable date output for invalid dates
gpsOnlyFilter	Restrict output to GPS satellites only
trackFilt	Enable COG output even if COG is frozen

Bitfield flags

This graphic explains the bits of `flags`

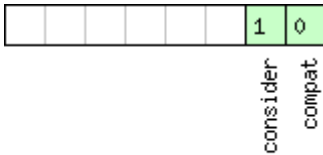

signed value
 unsigned value
 reserved

Name	Description
<code>compat</code>	enable compatibility mode. This might be needed for certain applications when customer's NMEA parser expects a fixed number of digits in position coordinates
<code>consider</code>	enable considering mode.

Bitfield `gnssToFilter`

This graphic explains the bits of `gnssToFilter`

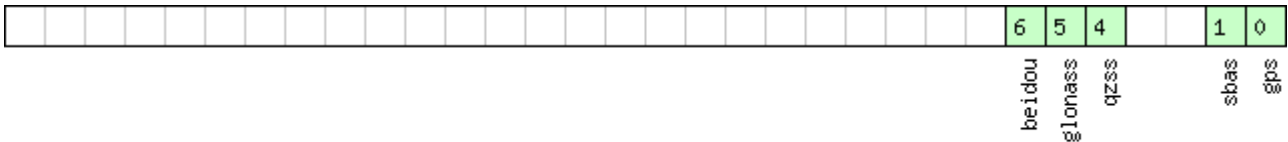

signed value
 unsigned value
 reserved

Name	Description
<code>gps</code>	Disable reporting of GPS satellites
<code>sbas</code>	Disable reporting of SBAS satellites
<code>qzss</code>	Disable reporting of QZSS satellites
<code>glonass</code>	Disable reporting of GLONASS satellites
<code>beidou</code>	Disable reporting of BeiDou satellites

31.11.18.3 Extended NMEA protocol configuration V1

Message	CFG-NMEA					
Description	Extended NMEA protocol configuration V1					
Firmware	Supported on: <ul style="list-style-type: none"> u-blox 8 / u-blox M8 from protocol version 15 up to version 23.01 					
Type	Get/Set					
Comment	Set/Get the NMEA protocol configuration. See section NMEA Protocol Configuration for a detailed description of the configuration effects on NMEA output.					
Message Structure	Header	Class	ID	Length (Bytes)	Payload	Checksum
	0xB5 0x62	0x06	0x17	20	see below	CK_A CK_B
Payload Contents:						
Byte Offset	Number Format	Scaling	Name	Unit	Description	
0	X1	-	filter	-	filter flags (see graphic below)	

CFG-NMEA continued

Byte Offset	Number Format	Scaling	Name	Unit	Description
1	U1	-	nmeaVersion	-	0x41: NMEA version 4.1 0x40: NMEA version 4.0 0x23: NMEA version 2.3 0x21: NMEA version 2.1
2	U1	-	numSV	-	Maximum Number of SVs to report per TalkerId. 0: unlimited 8: 8 SVs 12: 12 SVs 16: 16 SVs
3	X1	-	flags	-	flags (see graphic below)
4	X4	-	gnssToFilter	-	Filters out satellites based on their GNSS. If a bitfield is enabled, the corresponding satellites will be not output. (see graphic below)
8	U1	-	svNumbering	-	Configures the display of satellites that do not have an NMEA-defined value. Note: this does not apply to satellites with an unknown ID. 0: Strict - Satellites are not output 1: Extended - Use proprietary numbering (see Satellite numbering)
9	U1	-	mainTalkerId	-	By default the main Talker ID (i.e. the Talker ID used for all messages other than GSV) is determined by the GNSS assignment of the receiver's channels (see UBX-CFG-GNSS). This field enables the main Talker ID to be overridden. 0: Main Talker ID is not overridden 1: Set main Talker ID to 'GP' 2: Set main Talker ID to 'GL' 3: Set main Talker ID to 'GN' 4: Set main Talker ID to 'GA' 5: Set main Talker ID to 'GB'
10	U1	-	gsvTalkerId	-	By default the Talker ID for GSV messages is GNSS specific (as defined by NMEA). This field enables the GSV Talker ID to be overridden. 0: Use GNSS specific Talker ID (as defined by NMEA) 1: Use the main Talker ID
11	U1	-	version	-	Message version (set to 1 for this version)
12	CH[2]	-	bdsTalkerId	-	Sets the two characters that should be used for the BeiDou Talker ID If these are set to zero, the default BeiDou TalkerId will be used

CFG-NMEA continued

Byte Offset	Number Format	Scaling	Name	Unit	Description
14	U1[6]	-	reserved1	-	Reserved

Bitfield filter

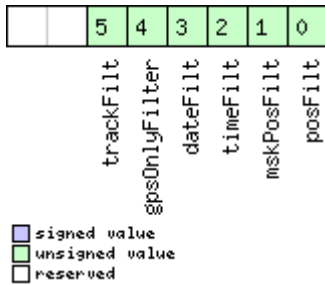
 This graphic explains the bits of `filter`

Name	Description
<code>posFilt</code>	Enable position output for failed or invalid fixes
<code>mskPosFilt</code>	Enable position output for invalid fixes
<code>timeFilt</code>	Enable time output for invalid times
<code>dateFilt</code>	Enable date output for invalid dates
<code>gpsOnlyFilter</code>	Restrict output to GPS satellites only
<code>trackFilt</code>	Enable COG output even if COG is frozen

Bitfield flags

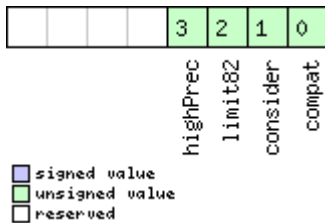
 This graphic explains the bits of `flags`

Name	Description
<code>compat</code>	enable compatibility mode. This might be needed for certain applications when customer's NMEA parser expects a fixed number of digits in position coordinates
<code>consider</code>	enable considering mode.
<code>limit82</code>	enable strict limit to 82 characters maximum.
<code>highPrec</code>	enable high precision mode. This flag cannot be set in conjunction with either Compatibility Mode or Limit82 Mode. (not supported in protocol versions less than 20.01)

Bitfield gnsstoFilter

This graphic explains the bits of `gnsstoFilter`

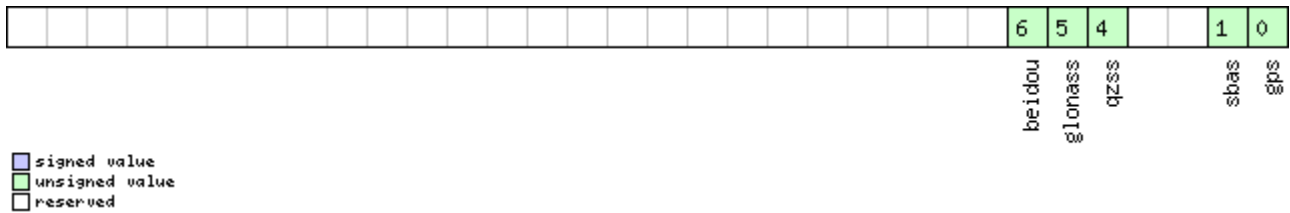

Name	Description
gps	Disable reporting of GPS satellites
sbas	Disable reporting of SBAS satellites
qzss	Disable reporting of QZSS satellites
glonass	Disable reporting of GLONASS satellites
beidou	Disable reporting of BeiDou satellites

31.11.19 UBX-CFG-ODO (0x06 0x1E)

31.11.19.1 Odometer, Low-speed COG Engine Settings

Message	CFG-ODO					
Description	Odometer, Low-speed COG Engine Settings					
Firmware	Supported on: <ul style="list-style-type: none"> u-blox 8 / u-blox M8 from protocol version 15 up to version 23.01 					
Type	Get/Set					
Comment	This feature is not supported for the FTS product variant.					
	-					
Message Structure	Header	Class	ID	Length (Bytes)	Payload	Checksum
	0xB5 0x62	0x06	0x1E	20	see below	CK_A CK_B
Payload Contents:						
Byte Offset	Number Format	Scaling	Name	Unit	Description	
0	U1	-	version	-	Message version (0 for this version)	
1	U1[3]	-	reserved1	-	Reserved	
4	U1	-	flags	-	Odometer/Low-speed COG filter flags (see graphic below)	
5	X1	-	odoCfg	-	Odometer filter settings (see graphic below)	
6	U1[6]	-	reserved2	-	Reserved	
12	U1	1e-1	cogMaxSpeed	m/s	Speed below which course-over-ground (COG) is computed with the low-speed COG filter	
13	U1	-	cogMaxPosAcc	m	Maximum acceptable position accuracy for computing COG with the low-speed COG filter	
14	U1[2]	-	reserved3	-	Reserved	
16	U1	-	velLpGain	-	Velocity low-pass filter level, range 0..255	
17	U1	-	cogLpGain	-	COG low-pass filter level (at speed < 8 m/s), range 0..255	
18	U1[2]	-	reserved4	-	Reserved	

Bitfield flags

This graphic explains the bits of flags

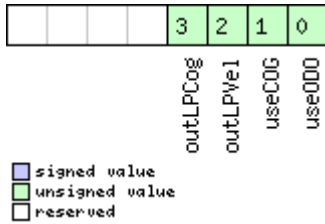

Name	Description
useODO	Odometer enabled flag
useCOG	Low-speed COG filter enabled flag
outLPVcl	Output low-pass filtered velocity flag
outLPCog	Output low-pass filtered heading (COG) flag

Bitfield odoCfg

This graphic explains the bits of odoCfg

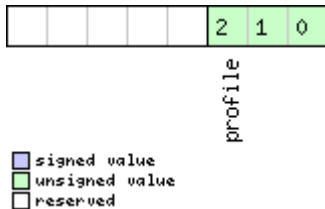

Name	Description
profile	Profile type (0=running, 1=cycling, 2=swimming, 3=car, 4=custom)

31.11.20 UBX-CFG-PM2 (0x06 0x3B)

31.11.20.1 Extended Power Management configuration

Message	CFG-PM2					
Description	Extended Power Management configuration					
Firmware	Supported on: <ul style="list-style-type: none"> u-blox 8 / u-blox M8 from protocol version 15 up to version 23.01 This message is marked as deprecated in protocol version 18 and is likely to be removed in any future products. u-blox strongly advises to use Version 2 instead.					
Type	Get/Set					
Comment	This feature is not supported for either the ADR or FTS products.					
Message Structure	Header	Class	ID	Length (Bytes)	Payload	Checksum
	0xB5 0x62	0x06	0x3B	44	see below	CK_A CK_B
Payload Contents:						
Byte Offset	Number Format	Scaling	Name	Unit	Description	
0	U1	-	version	-	Message version (0x01 for this version)	
1	U1	-	reserved1	-	Reserved	

CFG-PM2 continued

Byte Offset	Number Format	Scaling	Name	Unit	Description
2	U1	-	maxStartupStateDur	s	Maximum time to spend in <i>Acquisition</i> state. If 0: bound disabled (see maxStartupStateDur). (not supported in protocol versions less than 17)
3	U1	-	reserved2	-	Reserved
4	X4	-	flags	-	PSM configuration flags (see graphic below)
8	U4	-	updatePeriod	ms	Position update period. If set to 0, the receiver will never retry a fix and it will wait for external events
12	U4	-	searchPeriod	ms	Acquisition retry period if previously failed. If set to 0, the receiver will never retry a startup
16	U4	-	gridOffset	ms	Grid offset relative to GPS start of week
20	U2	-	onTime	s	Time to stay in <i>Tracking</i> state
22	U2	-	minAcqTime	s	minimal search time
24	U1[20]	-	reserved3	-	Reserved

Bitfield flags

This graphic explains the bits of flags

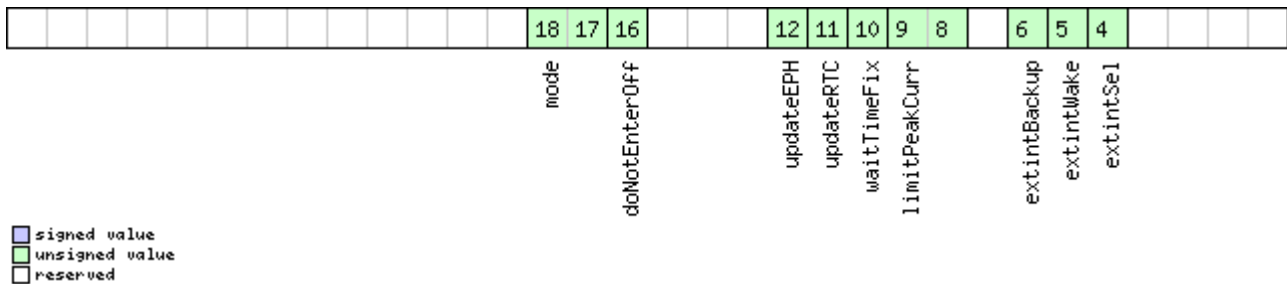

Name	Description
extintSel	EXTINT Pin Select 0 EXTINT0 1 EXTINT1
extintWake	EXTINT Pin Control 0 disabled 1 enabled, keep receiver awake as long as selected EXTINT pin is 'high'
extintBackup	EXTINT Pin Control 0 disabled 1 enabled, force receiver into BACKUP mode when selected EXTINT pin is 'low'
limitPeakCurr	Limit Peak Current 00 disabled 01 enabled, peak current is limited 10 reserved 11 reserved
waitTimeFix	Wait for Timefix (see waitTimeFix) 0 wait for normal fix ok before starting on time 1 wait for time fix ok before starting on time

Bitfield flags Description continued

Name	Description
updateRTC	Update Real Time Clock (see updateRTC) 0 Do not wake up to update RTC. RTC is updated during normal on-time. 1 Update RTC. The receiver adds extra wake-up cycles to update the RTC.
updateEPH	Update Ephemeris (see updateEPH) 0 Do not wake up to update Ephemeris data 1 Update Ephemeris. The receiver adds extra wake-up cycles to update the Ephemeris data
doNotEnterOff	Behavior of receiver in case of no fix (see doNotEnterOff) 0 receiver enters <i>(Inactive) Awaiting Next Search</i> state 1 receiver does not enter <i>(Inactive) Awaiting Next Search</i> state but keeps trying to acquire a fix instead
mode	Mode of operation (see mode) 00 ON/OFF operation (PSMOO) 01 Cyclic tracking operation (PSMCT) 10 reserved 11 reserved

31.11.20.2 Extended Power Management configuration

Message	CFG-PM2					
Description	Extended Power Management configuration					
Firmware	Supported on: <ul style="list-style-type: none"> u-blox 8 / u-blox M8 from protocol version 18 up to version 23.01 					
Type	Get/Set					
Comment	This feature is not supported for either the ADR or FTS products. -					
Message Structure	Header	Class	ID	Length (Bytes)	Payload	Checksum
	0xB5 0x62	0x06	0x3B	48	see below	CK_A CK_B
Payload Contents:						
Byte Offset	Number Format	Scaling	Name	Unit	Description	
0	U1	-	version	-	Message version (0x02 for this version)	
1	U1	-	reserved1	-	Reserved	
2	U1	-	maxStartupStateDur	s	Maximum time to spend in <i>Acquisition</i> state. If 0: bound disabled (see maxStartupStateDur). (not supported in protocol versions less than 17), (not supported in protocol versions 23 to 23.01)	
3	U1	-	reserved2	-	Reserved	
4	X4	-	flags	-	PSM configuration flags (see graphic below)	
8	U4	-	updatePeriod	ms	Position update period. If set to 0, the receiver will never retry a fix and it will wait for external events	
12	U4	-	searchPeriod	ms	Acquisition retry period if previously failed. If set to 0, the receiver will never retry a startup (not supported in protocol versions 23 to 23.01)	

CFG-PM2 continued

Byte Offset	Number Format	Scaling	Name	Unit	Description
16	U4	-	gridOffset	ms	Grid offset relative to GPS start of week (not supported in protocol versions 23 to 23.01)
20	U2	-	onTime	s	Time to stay in <i>Tracking</i> state (not supported in protocol versions 23 to 23.01)
22	U2	-	minAcqTime	s	minimal search time
24	U1[20]	-	reserved3	-	Reserved
44	U4	-	extintInactivityMs	ms	inactivity time out on EXTINT pint if enabled

Bitfield flags

This graphic explains the bits of flags

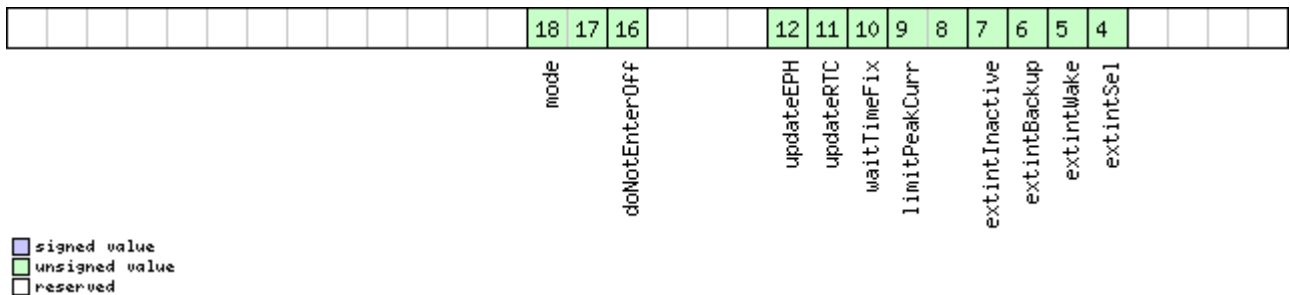

Name	Description
extintSel	EXTINT Pin Select 0 EXTINT0 1 EXTINT1
extintWake	EXTINT Pin Control 0 disabled 1 enabled, keep receiver awake as long as selected EXTINT pin is 'high'
extintBackup	EXTINT Pin Control 0 disabled 1 enabled, force receiver into BACKUP mode when selected EXTINT pin is 'low'
extintInactive	EXTINT Pin Control 0 disabled 1 enabled, Force backup in case EXTINT Pin is inactive for time longer than extintInactivityMs
limitPeakCurr	Limit Peak Current 00 disabled 01 enabled, peak current is limited 10 reserved 11 reserved
waitTimeFix	Wait for Timefix (see waitTimeFix) 0 wait for normal fix ok before starting on time 1 wait for time fix ok before starting on time (not supported in protocol versions 23 to 23.01)
updateRTC	Update Real Time Clock (see updateRTC) 0 Do not wake up to update RTC. RTC is updated during normal on-time. 1 Update RTC. The receiver adds extra wake-up cycles to update the RTC. (not supported in protocol versions 23 to 23.01)

Bitfield flags Description continued

Name	Description
updateEPH	Update Ephemeris (see updateEPH) 0 Do not wake up to update Ephemeris data 1 Update Ephemeris. The receiver adds extra wake-up cycles to update the Ephemeris data
doNotEnterOff	Behavior of receiver in case of no fix (see doNotEnterOff) 0 receiver enters (<i>Inactive</i>) <i>Awaiting Next Search</i> state 1 receiver does not enter (<i>Inactive</i>) <i>Awaiting Next Search</i> state but keeps trying to acquire a fix instead (not supported in protocol versions 23 to 23.01)
mode	Mode of operation (see mode) 00 ON/OFF operation (<i>PSMOO</i>) (not supported in protocol versions 23 to 23.01) 01 Cyclic tracking operation (<i>PSMCT</i>) 10 reserved 11 reserved

31.11.21 UBX-CFG-PMS (0x06 0x86)
31.11.21.1 Power Mode Setup

Message	CFG-PMS					
Description	Power Mode Setup					
Firmware	Supported on: • u-blox 8 / u-blox M8 from protocol version 18 up to version 23.01					
Type	Get/Set					
Comment	-					
Message Structure	Header	Class	ID	Length (Bytes)	Payload	Checksum
	0xB5 0x62	0x06	0x86	8	see below	CK_A CK_B
Payload Contents:						
Byte Offset	Number Format	Scaling	Name	Unit	Description	
0	U1	-	version	-	Message version (0x00 for this version)	
1	U1	-	powerSetupValue	-	Power setup value 0x00 -> Full power 0x01 -> Balanced 0x02 -> Interval 0x03 -> Aggressive with 1Hz 0x04 -> Aggressive with 2Hz 0x05 -> Aggressive with 4Hz 0xFF -> Invalid (only when polling)	
2	U2	-	period	s	Position update period and search period. Recommended minimum period is 10s, although the receiver accepts any value bigger than 5s. Only valid when <code>powerSetupValue</code> set to <code>Interval</code> , otherwise must be set to '0'.	

CFG-PMS continued

Byte Offset	Number Format	Scaling	Name	Unit	Description
4	U2	-	onTime	s	Duration of the ON phase, must be smaller than the period. Only valid when powerSetupValue set to Interval, otherwise must be set to '0'.
6	U1[2]	-	reserved1	-	Reserved

31.11.22 UBX-CFG-PRT (0x06 0x00)

31.11.22.1 Polls the configuration for one I/O Port

Message	CFG-PRT					
Description	Polls the configuration for one I/O Port					
Firmware	Supported on: <ul style="list-style-type: none"> u-blox 8 / u-blox M8 from protocol version 15 up to version 23.01 					
Type	Poll Request					
Comment	Sending this message with a port ID as payload results in having the receiver return the configuration for the specified port.					
Message Structure	Header	Class	ID	Length (Bytes)	Payload	Checksum
	0xB5 0x62	0x06	0x00	1	see below	CK_A CK_B
Payload Contents:						
Byte Offset	Number Format	Scaling	Name	Unit	Description	
0	U1	-	PortID	-	Port Identifier Number (see the other versions of CFG-PRT for valid values)	

31.11.22.2 Port Configuration for UART

Message	CFG-PRT					
Description	Port Configuration for UART					
Firmware	Supported on: <ul style="list-style-type: none"> u-blox 8 / u-blox M8 from protocol version 15 up to version 23.01 					
Type	Get/Set					
Comment	Several configurations can be concatenated to one input message. In this case the payload length can be a multiple of the normal length (see the other versions of CFG-PRT). Output messages from the module contain only one configuration unit. Note that this message can affect baud rate and other transmission parameters. Because there may be messages queued for transmission there may be uncertainty about which protocol applies to such messages. In addition a message currently in transmission may be corrupted by a protocol change. Host data reception parameters may have to be changed to be able to receive future messages, including the acknowledge message resulting from the CFG-PRT message.					
Message Structure	Header	Class	ID	Length (Bytes)	Payload	Checksum
	0xB5 0x62	0x06	0x00	20	see below	CK_A CK_B
Payload Contents:						

CFG-PRT continued

Byte Offset	Number Format	Scaling	Name	Unit	Description
0	U1	-	portID	-	Port Identifier Number (see Serial Communication Ports Description for valid UART port IDs)
1	U1	-	reserved1	-	Reserved
2	X2	-	txReady	-	TX ready PIN configuration (see graphic below)
4	X4	-	mode	-	A bit mask describing the UART mode (see graphic below)
8	U4	-	baudRate	Bits/s	Baud rate in bits/second
12	X2	-	inProtoMask	-	A mask describing which input protocols are active. Each bit of this mask is used for a protocol. Through that, multiple protocols can be defined on a single port. (see graphic below)
14	X2	-	outProtoMask	-	A mask describing which output protocols are active. Each bit of this mask is used for a protocol. Through that, multiple protocols can be defined on a single port. (see graphic below)
16	X2	-	flags	-	Flags bit mask (see graphic below)
18	U1[2]	-	reserved2	-	Reserved

Bitfield txReady

This graphic explains the bits of txReady

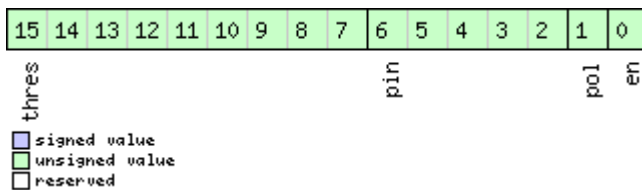

Name	Description
en	Enable TX ready feature for this port
pol	Polarity 0 High-active 1 Low-active
pin	PIO to be used (must not be in use already by another function)

Bitfield txReady Description continued

Name	Description
thres	Threshold The given threshold is multiplied by 8 bytes. The TX ready PIN goes active after $\geq \text{thres} * 8$ bytes are pending for the port and going inactive after the last pending bytes have been written to hardware (0-4 bytes before end of stream). 0x000 no threshold 0x001 8byte 0x002 16byte ... 0x1FE 4080byte 0x1FF 4088byte

Bitfield mode

This graphic explains the bits of mode

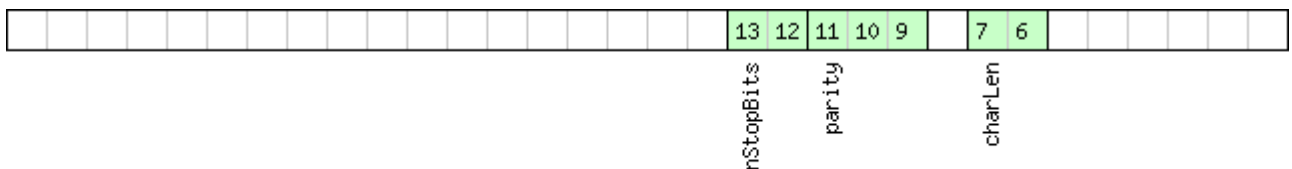

- signed value
- unsigned value
- reserved

Name	Description
charLen	Character Length 00 5bit (not supported) 01 6bit (not supported) 10 7bit (supported only with parity) 11 8bit
parity	000 Even Parity 001 Odd Parity 10X No Parity X1X Reserved
nStopBits	Number of Stop Bits 00 1 Stop Bit 01 1.5 Stop Bit 10 2 Stop Bit 11 0.5 Stop Bit

Bitfield inProtoMask

This graphic explains the bits of inProtoMask

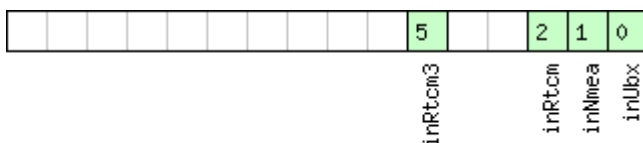

- signed value
- unsigned value
- reserved

Name	Description
------	-------------

Bitfield inProtoMask Description continued

Name	Description
inUbx	UBX protocol
inNmea	NMEA protocol
inRtcm	RTCM2 protocol
inRtcm3	RTCM3 protocol (not supported in protocol versions less than 20)

Bitfield outProtoMask

This graphic explains the bits of outProtoMask

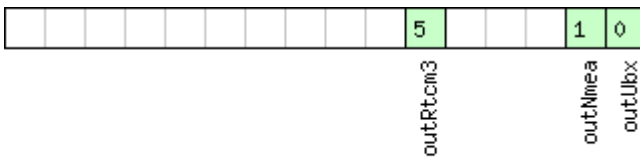

- signed value
- unsigned value
- reserved

Name	Description
outUbx	UBX protocol
outNmea	NMEA protocol
outRtcm3	RTCM3 protocol (not supported in protocol versions less than 20)

Bitfield flags

This graphic explains the bits of flags

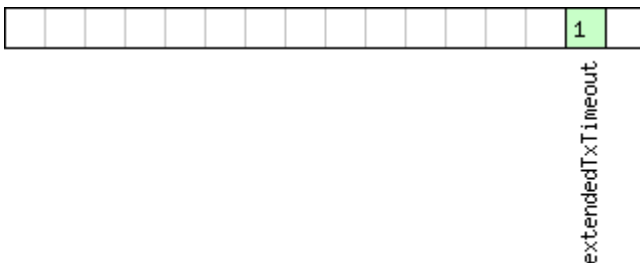

- signed value
- unsigned value
- reserved

Name	Description
extendedTxTimeout	Extended TX timeout: if set, the port will timeout if allocated TX memory ≥ 4 kB and no activity for 1.5s. If not set the port will timeout if no activity for 1.5s regardless on the amount of allocated TX memory.

31.11.22.3 Port Configuration for USB Port

Message	CFG-PRT					
Description	Port Configuration for USB Port					
Firmware	Supported on: <ul style="list-style-type: none"> • u-blox 8 / u-blox M8 from protocol version 15 up to version 23.01 					
Type	Get/Set					
Comment	Several configurations can be concatenated to one input message. In this case the payload length can be a multiple of the normal length (see the other versions of CFG-PRT). Output messages from the module contain only one configuration unit.					
Message Structure	Header	Class	ID	Length (Bytes)	Payload	Checksum
	0xB5 0x62	0x06	0x00	20	see below	CK_A CK_B
Payload Contents:						
Byte Offset	Number Format	Scaling	Name	Unit	Description	
0	U1	-	portID	-	Port Identifier Number (= 3 for USB port)	
1	U1	-	reserved1	-	Reserved	
2	X2	-	txReady	-	TX ready PIN configuration (see graphic below)	
4	U1[8]	-	reserved2	-	Reserved	
12	X2	-	inProtoMask	-	A mask describing which input protocols are active. Each bit of this mask is used for a protocol. Through that, multiple protocols can be defined on a single port. (see graphic below)	
14	X2	-	outProtoMask	-	A mask describing which output protocols are active. Each bit of this mask is used for a protocol. Through that, multiple protocols can be defined on a single port. (see graphic below)	
16	U1[2]	-	reserved3	-	Reserved	
18	U1[2]	-	reserved4	-	Reserved	

Bitfield txReady

This graphic explains the bits of txReady

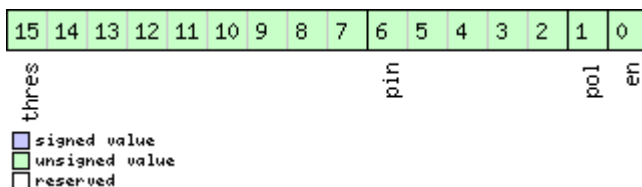

Name	Description
en	Enable TX ready feature for this port
pol	Polarity 0 High-active 1 Low-active
pin	PIO to be used (must not be in use already by another function)

Bitfield txReady Description continued

Name	Description
thres	Threshold The given threshold is multiplied by 8 bytes. The TX ready PIN goes active after $\geq \text{thres} * 8$ bytes are pending for the port and going inactive after the last pending bytes have been written to hardware (0-4 bytes before end of stream). 0x000 no threshold 0x001 8byte 0x002 16byte ... 0x1FE 4080byte 0x1FF 4088byte

Bitfield inProtoMask

This graphic explains the bits of inProtoMask

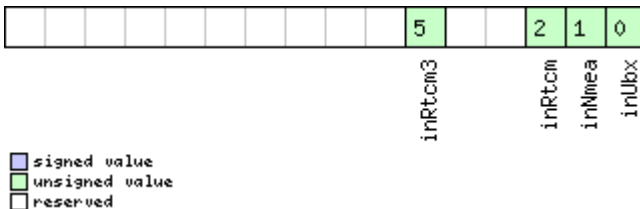

Name	Description
inUbx	UBX protocol
inNmea	NMEA protocol
inRtcm	RTCM2 protocol
inRtcm3	RTCM3 protocol (not supported in protocol versions less than 20)

Bitfield outProtoMask

This graphic explains the bits of outProtoMask

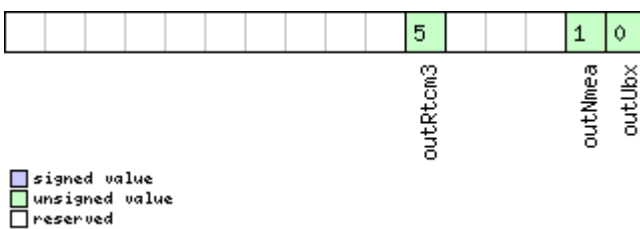

Name	Description
outUbx	UBX protocol
outNmea	NMEA protocol
outRtcm3	RTCM3 protocol (not supported in protocol versions less than 20)

31.11.22.4 Port Configuration for SPI Port

Message	CFG-PRT					
Description	Port Configuration for SPI Port					
Firmware	Supported on: <ul style="list-style-type: none"> u-blox 8 / u-blox M8 from protocol version 15 up to version 23.01 					
Type	Get/Set					
Comment	Several configurations can be concatenated to one input message. In this case the payload length can be a multiple of the normal length (see the other versions of CFG-PRT). Output messages from the module contain only one configuration unit.					
Message Structure	Header	Class	ID	Length (Bytes)	Payload	Checksum
	0xB5 0x62	0x06	0x00	20	see below	CK_A CK_B
Payload Contents:						
Byte Offset	Number Format	Scaling	Name	Unit	Description	
0	U1	-	portID	-	Port Identifier Number (= 4 for SPI port)	
1	U1	-	reserved1	-	Reserved	
2	X2	-	txReady	-	TX ready PIN configuration (see graphic below)	
4	X4	-	mode	-	SPI Mode Flags (see graphic below)	
8	U1[4]	-	reserved2	-	Reserved	
12	X2	-	inProtoMask	-	A mask describing which input protocols are active. Each bit of this mask is used for a protocol. Through that, multiple protocols can be defined on a single port. (The bitfield inRtcm3 is not supported in protocol versions less than 20) (see graphic below)	
14	X2	-	outProtoMask	-	A mask describing which output protocols are active. Each bit of this mask is used for a protocol. Through that, multiple protocols can be defined on a single port. (The bitfield outRtcm3 is not supported in protocol versions less than 20) (see graphic below)	
16	X2	-	flags	-	Flags bit mask (see graphic below)	
18	U1[2]	-	reserved3	-	Reserved	

Bitfield txReady

This graphic explains the bits of txReady

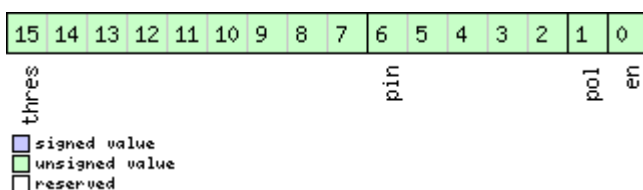

Bitfield txReady Description continued

Name	Description
en	Enable TX ready feature for this port
pol	Polarity 0 High-active 1 Low-active
pin	PIO to be used (must not be in use already by another function)
thres	Threshold The given threshold is multiplied by 8 bytes. The TX ready PIN goes active after \geq thres*8 bytes are pending for the port and going inactive after the last pending bytes have been written to hardware (0-4 bytes before end of stream). 0x000 no threshold 0x001 8byte 0x002 16byte ... 0x1FE 4080byte 0x1FF 4088byte

Bitfield mode

This graphic explains the bits of mode

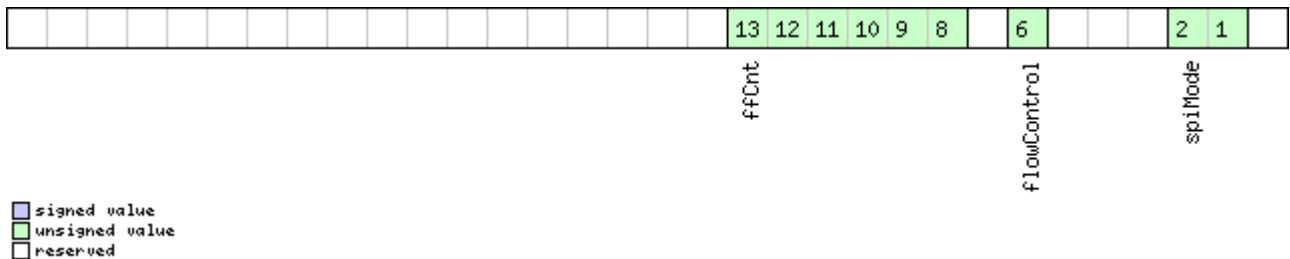

Name	Description
spiMode	00 SPI Mode 0: CPOL = 0, CPHA = 0 01 SPI Mode 1: CPOL = 0, CPHA = 1 10 SPI Mode 2: CPOL = 1, CPHA = 0 11 SPI Mode 3: CPOL = 1, CPHA = 1
flowControl	(u-blox 6 only) 0 Flow control disabled 1 Flow control enabled (9-bit mode)
ffCnt	Number of bytes containing 0xFF to receive before switching off reception. Range: 0(mechanism off)-63

Bitfield inProtoMask

This graphic explains the bits of inProtoMask

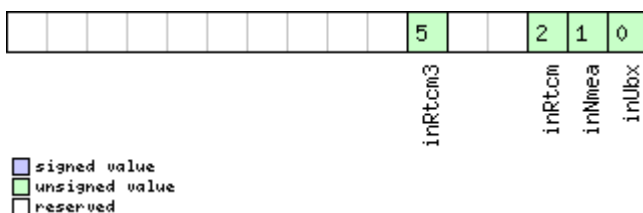

Bitfield outProtoMask

This graphic explains the bits of outProtoMask

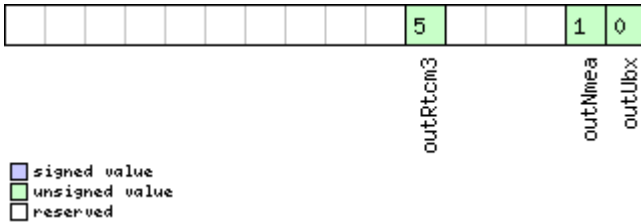

Bitfield flags

This graphic explains the bits of flags

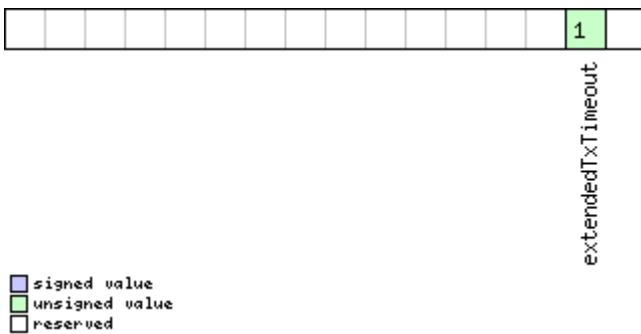

Name	Description
extendedTxTimeout	Extended TX timeout: if set, the port will timeout if allocated TX memory ≥ 4 kB and no activity for 1.5s.

31.11.22.5 Port Configuration for DDC Port

Message	CFG-PRT					
Description	Port Configuration for DDC Port					
Firmware	Supported on: <ul style="list-style-type: none"> u-blox 8 / u-blox M8 from protocol version 15 up to version 23.01 					
Type	Get/Set					
Comment	Several configurations can be concatenated to one input message. In this case the payload length can be a multiple of the normal length (see the other versions of CFG-PRT). Output messages from the module contain only one configuration unit.					
Message Structure	Header	Class	ID	Length (Bytes)	Payload	Checksum
	0xB5 0x62	0x06	0x00	20	see below	CK_A CK_B
Payload Contents:						
Byte Offset	Number Format	Scaling	Name	Unit	Description	
0	U1	-	portID	-	Port Identifier Number (= 0 for DDC port)	
1	U1	-	reserved1	-	Reserved	
2	X2	-	txReady	-	TX ready PIN configuration (see graphic below)	
4	X4	-	mode	-	DDC Mode Flags (see graphic below)	
8	U1[4]	-	reserved2	-	Reserved	

CFG-PRT continued

Byte Offset	Number Format	Scaling	Name	Unit	Description
12	X2	-	inProtoMask	-	A mask describing which input protocols are active. Each bit of this mask is used for a protocol. Through that, multiple protocols can be defined on a single port. (The bitfield inRtcm3 is not supported in protocol versions less than 20) (see graphic below)
14	X2	-	outProtoMask	-	A mask describing which output protocols are active. Each bit of this mask is used for a protocol. Through that, multiple protocols can be defined on a single port. (The bitfield outRtcm3 is not supported in protocol versions less than 20) (see graphic below)
16	X2	-	flags	-	Flags bit mask (see graphic below)
18	U1[2]	-	reserved3	-	Reserved

Bitfield txReady

This graphic explains the bits of txReady

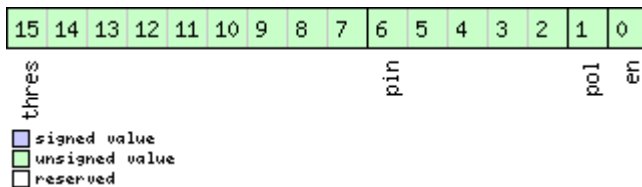

Name	Description
en	Enable TX ready feature for this port
pol	Polarity 0 High-active 1 Low-active
pin	PIO to be used (must not be in use already by another function)
thres	Threshold The given threshold is multiplied by 8 bytes. The TX ready PIN goes active after $\geq \text{thres} * 8$ bytes are pending for the port and going inactive after the last pending bytes have been written to hardware (0-4 bytes before end of stream). 0x000 no threshold 0x001 8byte 0x002 16byte ... 0x1FE 4080byte 0x1FF 4088byte

Bitfield mode

This graphic explains the bits of mode

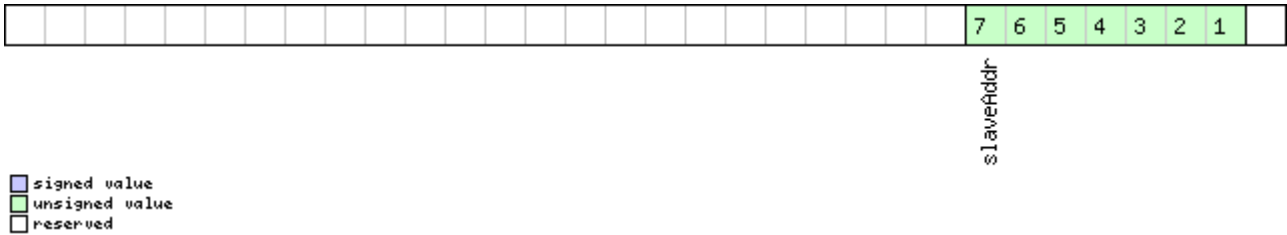

Name	Description
slaveAddr	Slave address Range: 0x07 < slaveAddr < 0x78. Bit 0 must be 0

Bitfield inProtoMask

This graphic explains the bits of inProtoMask

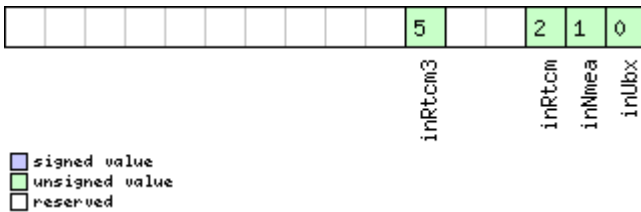

Bitfield outProtoMask

This graphic explains the bits of outProtoMask

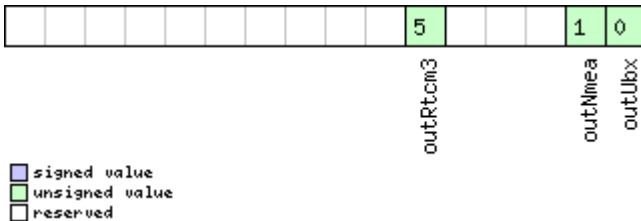

Bitfield flags

This graphic explains the bits of flags

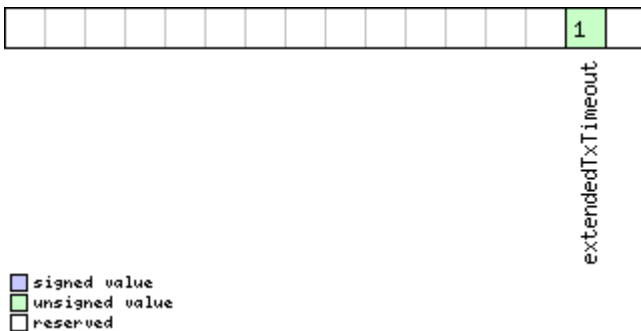

Name	Description
extendedTxTimeout	Extended TX timeout: if set, the port will timeout if allocated TX memory ≥ 4 kB and no activity for 1.5s.

31.11.23 UBX-CFG-PWR (0x06 0x57)

31.11.23.1 Put receiver in a defined power state.

Message	CFG-PWR					
Description	Put receiver in a defined power state.					
Firmware	Supported on: <ul style="list-style-type: none"> u-blox 8 / u-blox M8 from protocol version 15 up to version 23.01 					
Type	Set					
Comment	This message is deprecated in protocol versions greater than 17. Use UBX-CFG-RST for GNSS start/stop and UBX-RXM-PMREQ for software backup. -					
Message Structure	Header	Class	ID	Length (Bytes)	Payload	Checksum
	0xB5 0x62	0x06	0x57	8	see below	CK_A CK_B
Payload Contents:						
Byte Offset	Number Format	Scaling	Name	Unit	Description	
0	U1	-	version	-	Message version (1 for this version)	
1	U1[3]	-	reserved1	-	Reserved	
4	U4	-	state	-	Enter system state 0x52554E20: GNSS running 0x53544F50: GNSS stopped 0x42434B50: Software Backup. USB interface will be disabled, other wakeup source is needed.	

31.11.24 UBX-CFG-RATE (0x06 0x08)

31.11.24.1 Navigation/Measurement Rate Settings

Message	CFG-RATE					
Description	Navigation/Measurement Rate Settings					
Firmware	Supported on: <ul style="list-style-type: none"> u-blox 8 / u-blox M8 from protocol version 15 up to version 23.01 					
Type	Get/Set					
Comment	<p>This feature is not supported for the FTS product variant.</p> <p>This message allows the user to alter the rate at which navigation solutions (and the measurements that they depend on) are generated by the receiver. The calculation of the navigation solution will always be aligned to the top of a second zero (first second of the week) of the configured reference time system.</p> <p>For protocol version 18 and later the navigation period is an integer multiple of the measurement period.</p> <ul style="list-style-type: none"> Each measurement triggers the measurements generation and raw data output. The navRate value defines that every nth measurement triggers a navigation epoch. The update rate has a direct influence on the power consumption. The more fixes that are required, the more CPU power and communication resources are required. For most applications a 1 Hz update rate would be sufficient. When using Power Save Mode, measurement and navigation rate can differ from the values configured here. See Measurement and navigation rate with Power Save Mode 					

		for details.					
Message Structure		Header	Class	ID	Length (Bytes)	Payload	Checksum
		0xB5 0x62	0x06	0x08	6	see below	CK_A CK_B
Payload Contents:							
Byte Offset	Number Format	Scaling	Name	Unit	Description		
0	U2	-	measRate	ms	The elapsed time between GNSS measurements, which defines the rate, e.g. 100ms => 10Hz, 1000ms => 1Hz, 10000ms => 0.1Hz		
2	U2	-	navRate	cycles	The ratio between the number of measurements and the number of navigation solutions, e.g. 5 means five measurements for every navigation solution. Max. value is 127. (This parameter is ignored and the navRate is fixed to 1 in protocol versions less than 18)		
4	U2	-	timeRef	-	The time system to which measurements are aligned: 0: UTC time 1: GPS time 2: GLONASS time (not supported in protocol versions less than 18) 3: BeiDou time (not supported in protocol versions less than 18) 4: Galileo time (not supported in protocol versions less than 18)		

31.11.25 UBX-CFG-RINV (0x06 0x34)

31.11.25.1 Contents of Remote Inventory

Message	CFG-RINV						
Description	Contents of Remote Inventory						
Firmware	Supported on: <ul style="list-style-type: none"> u-blox 8 / u-blox M8 from protocol version 15 up to version 23.01 						
Type	Get/Set						
Comment	If <i>N</i> is greater than 30, the excess bytes are discarded. In future firmware versions, this limit may change.						
Message Structure		Header	Class	ID	Length (Bytes)	Payload	Checksum
		0xB5 0x62	0x06	0x34	1 + 1*N	see below	CK_A CK_B
Payload Contents:							
Byte Offset	Number Format	Scaling	Name	Unit	Description		
0	X1	-	flags	-	Flags (see graphic below)		
Start of repeated block (<i>N</i> times)							
1 + 1*N	U1	-	data	-	Data to store/stored in Remote Inventory		
End of repeated block							

Bitfield flags

This graphic explains the bits of flags

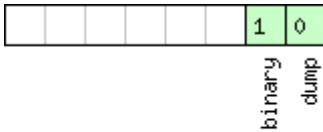

- signed value
- unsigned value
- reserved

Name	Description
dump	Dump data at startup. Does not work if flag binary is set.
binary	Data is binary

31.11.26 UBX-CFG-RST (0x06 0x04)

31.11.26.1 Reset Receiver / Clear Backup Data Structures

Message	CFG-RST					
Description	Reset Receiver / Clear Backup Data Structures					
Firmware	Supported on: <ul style="list-style-type: none"> • u-blox 8 / u-blox M8 from protocol version 15 up to version 23.01 					
Type	Command					
Comment	Don't expect this message to be acknowledged by the receiver. <ul style="list-style-type: none"> • Newer FW version won't acknowledge this message at all. • Older FW version will acknowledge this message but the acknowledge may not be sent completely before the receiver is reset. 					
Message Structure	Header	Class	ID	Length (Bytes)	Payload	Checksum
	0xB5 0x62	0x06	0x04	4	see below	CK_A CK_B
Payload Contents:						
Byte Offset	Number Format	Scaling	Name	Unit	Description	
0	X2	-	navBbrMask	-	BBR Sections to clear. The following Special Sets apply: 0x0000 Hot start 0x0001 Warm start 0xFFFF Cold start (see graphic below)	
2	U1	-	resetMode	-	Reset Type 0x00 - Hardware reset (Watchdog) immediately 0x01 - Controlled Software reset 0x02 - Controlled Software reset (GNSS only) 0x04 - Hardware reset (Watchdog) after shutdown 0x08 - Controlled GNSS stop 0x09 - Controlled GNSS start	
3	U1	-	reserved1	-	Reserved	

Bitfield navBbrMask

This graphic explains the bits of navBbrMask

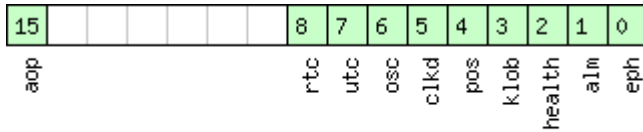

signed value
 unsigned value
 reserved

Name	Description
eph	Ephemeris
alm	Almanac
health	Health
klob	Klobuchar parameters
pos	Position
clkd	Clock Drift
osc	Oscillator Parameter
utc	UTC Correction + GPS Leap Seconds Parameters
rtc	RTC
aop	Autonomous Orbit Parameters

31.11.27 UBX-CFG-RXM (0x06 0x11)

31.11.27.1 RXM configuration

Message	CFG-RXM					
Description	RXM configuration					
Firmware	Supported on: <ul style="list-style-type: none"> u-blox 8 / u-blox M8 from protocol version 15 up to version 17 					
Type	Get/Set					
Comment	For a detailed description see section Power Management . Note that Power Save Mode cannot be selected when the receiver is configured to process GLONASS signals (using CFG-GNSS).					
Message Structure	Header	Class	ID	Length (Bytes)	Payload	Checksum
	0xB5 0x62	0x06	0x11	2	see below	CK_A CK_B
Payload Contents:						
Byte Offset	Number Format	Scaling	Name	Unit	Description	
0	U1	-	reserved1	-	Reserved	
1	U1	-	lpMode	-	Low Power Mode 0: Continuous Mode 1: Power Save Mode 4: Continuous Mode Note that for receivers with protocol versions larger or equal to 14, both Low Power Mode settings 0 and 4 configure the receiver to Continuous Mode.	

31.11.27.2 RXM configuration

Message		CFG-RXM					
Description		RXM configuration					
Firmware		Supported on: <ul style="list-style-type: none"> • u-blox 8 / u-blox M8 from protocol version 18 up to version 23.01 					
Type		Get/Set					
Comment		For a detailed description see section Power Management .					
Message Structure		Header	Class	ID	Length (Bytes)	Payload	Checksum
		0xB5 0x62	0x06	0x11	2	see below	CK_A CK_B
Payload Contents:							
Byte Offset	Number Format	Scaling	Name	Unit	Description		
0	U1	-	reserved1	-	Reserved		
1	U1	-	lpMode	-	Low Power Mode 0: Continuous Mode 1: Power Save Mode 4: Continuous Mode		

31.11.28 UBX-CFG-SBAS (0x06 0x16)

31.11.28.1 SBAS Configuration

Message		CFG-SBAS					
Description		SBAS Configuration					
Firmware		Supported on: <ul style="list-style-type: none"> • u-blox 8 / u-blox M8 from protocol version 15 up to version 23.01 					
Type		Get/Set					
Comment		This message configures the SBAS receiver subsystem (i.e. WAAS, EGNOS, MSAS). See the SBAS Configuration Settings Description for a detailed description of how these settings affect receiver operation.					
Message Structure		Header	Class	ID	Length (Bytes)	Payload	Checksum
		0xB5 0x62	0x06	0x16	8	see below	CK_A CK_B
Payload Contents:							
Byte Offset	Number Format	Scaling	Name	Unit	Description		
0	X1	-	mode	-	SBAS Mode (see graphic below)		
1	X1	-	usage	-	SBAS Usage (see graphic below)		
2	U1	-	maxSBAS	-	Maximum Number of SBAS prioritized tracking channels (valid range: 0 - 3) to use (obsolete and superseded by UBX-CFG-GNSS in protocol versions 14+).		
3	X1	-	scanmode2	-	Continuation of scanmode bitmask below (see graphic below)		

CFG-SBAS continued

Byte Offset	Number Format	Scaling	Name	Unit	Description
4	X4	-	scanmode1	-	Which SBAS PRN numbers to search for (Bitmask) If all Bits are set to zero, auto-scan (i.e. all valid PRNs) are searched. Every bit corresponds to a PRN number (see graphic below)

Bitfield mode

This graphic explains the bits of mode

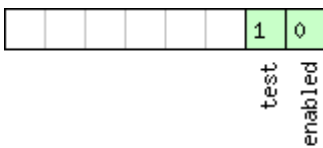

signed value
 unsigned value
 reserved

Name	Description
enabled	SBAS Enabled (1) / Disabled (0) - This field is deprecated; use <code>UBX-CFG-GNSS</code> to enable/disable SBAS operation
test	SBAS Testbed: Use data anyhow (1) / Ignore data when in Test Mode (SBAS Msg 0)

Bitfield usage

This graphic explains the bits of usage

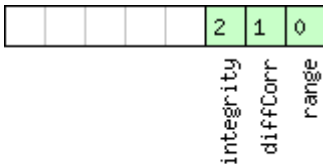

signed value
 unsigned value
 reserved

Name	Description
range	Use SBAS GEOs as a ranging source (for navigation)
diffCorr	Use SBAS Differential Corrections
integrity	Use SBAS Integrity Information

Bitfield scanmode2

This graphic explains the bits of scanmode2

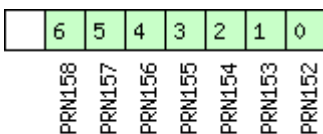

signed value
 unsigned value
 reserved

Bitfield scanmode1

This graphic explains the bits of `scanmode1`

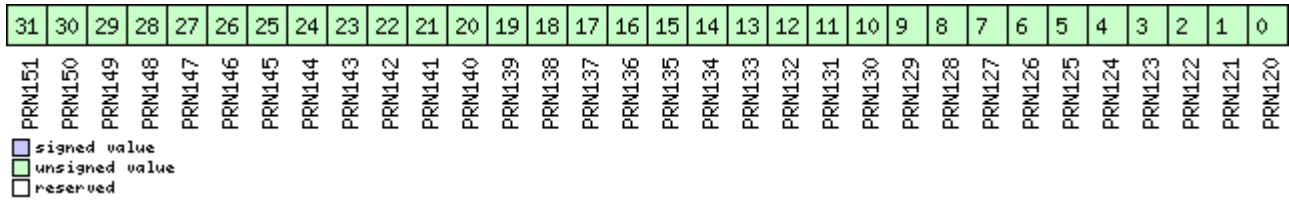

31.11.29 UBX-CFG-SMGR (0x06 0x62)

31.11.29.1 Synchronization manager configuration

Message	CFG-SMGR					
Description	Synchronization manager configuration					
Firmware	Supported on: <ul style="list-style-type: none"> u-blox 8 / u-blox M8 from protocol version 16 up to version 23.01 (only with Time & Frequency Sync products) 					
Type	Get/Set					
Comment	-					
Message Structure	Header	Class	ID	Length (Bytes)	Payload	Checksum
	0xB5 0x62	0x06	0x62	20	see below	CK_A CK_B
Payload Contents:						
Byte Offset	Number Format	Scaling	Name	Unit	Description	
0	U1	-	version	-	Message version (0 for this version)	
1	U1	-	minGNSSFix	-	Minimum number of GNSS fixes before we commit to use it as a source	
2	U2	-	maxFreqChangeRate	ppb/s	Maximum frequency change rate during disciplining. Must not exceed 30ppb/s	
4	U2	-	maxPhaseCorrectionRate	ns/s	Maximum phase correction rate in coherent time pulse mode. For maximum phase correction rate in corrective time pulse mode see maxSlewRate. Note that in coherent time pulse mode phase correction is achieved by intentional frequency offset. Allowing for a high phase correction rate can result in large intentional frequency offset. Must not exceed 100ns/s	
6	U1[2]	-	reserved1	-	Reserved	
8	U2	-	freqTolerance	ppb	Limit of possible deviation from nominal before TIM-TOS indicates that frequency is out of tolerance	
10	U2	-	timeTolerance	ns	Limit of possible deviation from nominal before TIM-TOS indicates that time pulse is out of tolerance	
12	X2	-	messageCfg	-	Sync manager message configuration (see graphic below)	

CFG-SMGR continued

Byte Offset	Number Format	Scaling	Name	Unit	Description
14	U2	-	maxSlewRate	us/s	Maximum slew rate, the maximum time correction that shall be applied between locked pulses in corrective time pulse mode. To have no limit on the slew rate, set the flag disableMaxSlewRate to 1 For maximum phase correction rate in coherent time pulse mode see maxPhaseCorrRate.
16	X4	-	flags	-	Flags (see graphic below)

Bitfield messageCfg

This graphic explains the bits of messageCfg

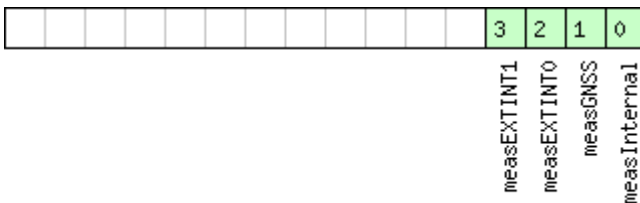

- signed value
- unsigned value
- reserved

Name	Description
measInternal	1 = report the estimated offset of the internal oscillator based on the oscillator model
measGNSS	1 = report the internal oscillator's offset relative to GNSS
measEXTINT0	1 = report the internal oscillator's offset relative to the source on EXTINT0
measEXTINT1	1 = report the internal oscillator's offset relative to the source on EXTINT1

Bitfield flags

This graphic explains the bits of flags

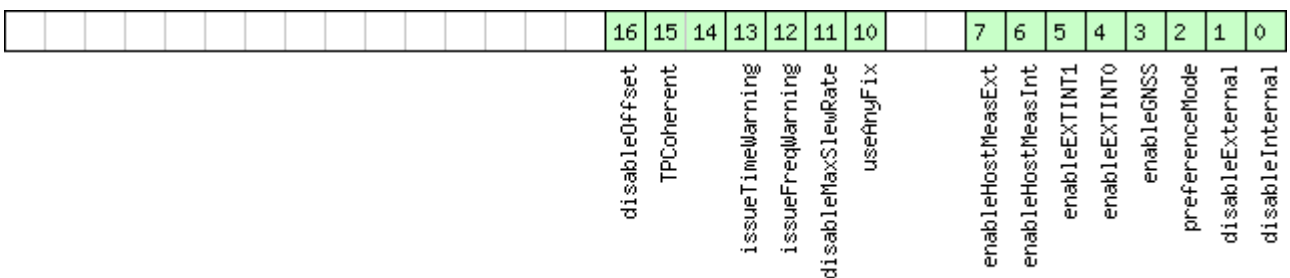

- signed value
- unsigned value
- reserved

Name	Description
disableInternal	1 = disable disciplining of the internal oscillator
disableExternal	1 = disable disciplining of the external oscillator

Bitfield flags Description continued

Name	Description
preferenceMode	Reference selection preference 0 - best frequency accuracy 1 - best phase accuracy
enableGNSS	1 = enable use of GNSS as synchronization source
enableEXTINT0	1 = enable use of EXTINT0 as synchronization source
enableEXTINT1	1 = enable use of EXTINT1 as synchronization source
enableHostMeasInt	1 = enable use of host measurements on the internal oscillator as synchronization source Measurements made by the host must be sent to the receiver using a TIM-SMEAS-DATA0 message.
enableHostMeasExt	1 = enable use of host measurements on the external oscillator as synchronization source Measurements made by the host must be sent to the receiver using a TIM-SMEAS-DATA0 message.
useAnyFix	0 - use over-determined navigation solutions only 1 - use any fix
disableMaxSlewRate	0 - use the value in the field maxSlewRate for maximum time correction in corrective time pulse mode 1 - don't use the value in the field maxSlewRate
issueFreqWarning	1 = issue a warning (via TIM-TOS flag) when frequency uncertainty exceeds freqTolerance
issueTimeWarning	1 = issue a warning (via TIM-TOS flag) when time uncertainty exceeds timeTolerance
TPCoherent	Control time pulse coherency 0 - Coherent pulses. Time phase offsets will be corrected gradually by varying the GNSS oscillator rate within frequency tolerance limits. There will always be the correct number of GNSS oscillator cycles between time pulses. Given tight limits this may take a long time 1 - Non-coherent pulses. In this mode the receiver will correct time phase offsets as quickly as allowed by the specified maximum slew rate, in which case there may not be the expected number of GNSS oscillator cycles between time pulses. 2 - Post-initialization coherent pulses. The receiver will run in non-coherent mode as described above until the pulse timing has been corrected and PLL is active on the internal oscillator, but will then switch to coherent pulse mode.
disableOffset	1 = disable automatic storage of oscillator offset

31.11.30 UBX-CFG-TMODE2 (0x06 0x3D)

31.11.30.1 Time Mode Settings 2

Message	CFG-TMODE2					
Description	Time Mode Settings 2					
Firmware	Supported on: <ul style="list-style-type: none"> u-blox 8 / u-blox M8 from protocol version 15 up to version 23.01 (only with Time Sync or Time & Frequency Sync products) 					
Type	Get/Set					
Comment	This message is available only for timing receivers See the Time Mode Description for details. This message replaces the deprecated UBX-CFG-TMODE message.					
Message Structure	Header	Class	ID	Length (Bytes)	Payload	Checksum
	0xB5 0x62	0x06	0x3D	28	see below	CK_A CK_B
Payload Contents:						

CFG-TMODE2 continued

Byte Offset	Number Format	Scaling	Name	Unit	Description
0	U1	-	timeMode	-	Time Transfer Mode: 0 Disabled 1 Survey In 2 Fixed Mode (true position information required) 3-255 Reserved
1	U1	-	reserved1	-	Reserved
2	X2	-	flags	-	Time mode flags (see graphic below)
4	I4	-	ecefXOrLat	cm_or_deg*1e-7	WGS84 ECEF X coordinate or latitude, depending on flags above
8	I4	-	ecefYOrLon	cm_or_deg*1e-7	WGS84 ECEF Y coordinate or longitude, depending on flags above
12	I4	-	ecefZOrAlt	cm	WGS84 ECEF Z coordinate or altitude, depending on flags above
16	U4	-	fixedPosAcc	mm	Fixed position 3D accuracy
20	U4	-	svinMinDur	s	Survey-in minimum duration
24	U4	-	svinAccLimit	mm	Survey-in position accuracy limit

Bitfield flags

This graphic explains the bits of flags

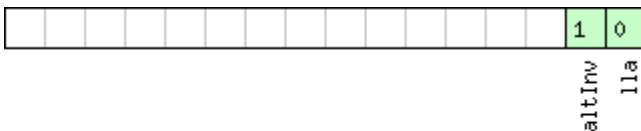

Name	Description
lla	Position is given in LAT/LON/ALT (default is ECEF)
altInv	Altitude is not valid, in case lla was set

31.11.31 UBX-CFG-TMODE3 (0x06 0x71)

31.11.31.1 Time Mode Settings 3

Message	CFG-TMODE3					
Description	Time Mode Settings 3					
Firmware	Supported on: <ul style="list-style-type: none"> u-blox 8 / u-blox M8 with protocol version 20 (only with High Precision GNSS products) 					
Type	Get/Set					
Comment	Configures the receiver to be in Time Mode. The position referred to in this message is that of the Antenna Reference Point (ARP). See the Time Mode Description for details.					
Message Structure	Header	Class	ID	Length (Bytes)	Payload	Checksum
	0xB5 0x62	0x06	0x71	40	see below	CK_A CK_B
Payload Contents:						
Byte Offset	Number Format	Scaling	Name	Unit	Description	
0	U1	-	version	-	Message version (0x00 for this version)	
1	U1	-	reserved1	-	Reserved	
2	X2	-	flags	-	Receiver mode flags (see graphic below)	
4	I4	-	ecefXOrLat	cm_or_deg*1e-7	WGS84 ECEF X coordinate (or latitude) of the ARP position, depending on flags above	
8	I4	-	ecefYOrLon	cm_or_deg*1e-7	WGS84 ECEF Y coordinate (or longitude) of the ARP position, depending on flags above	
12	I4	-	ecefZOrAlt	cm	WGS84 ECEF Z coordinate (or altitude) of the ARP position, depending on flags above	
16	I1	-	ecefXOrLatHP	0.1_mm_or_deg*1e-9	High-precision WGS84 ECEF X coordinate (or latitude) of the ARP position, depending on flags above. Must be in the range -99..+99. The precise WGS84 ECEF X coordinate in units of cm, or the precise WGS84 ECEF latitude in units of 1e-7 degrees, is given by ecefXOrLat + (ecefXOrLatHP * 1e-2)	
17	I1	-	ecefYOrLonHP	0.1_mm_or_deg*1e-9	High-precision WGS84 ECEF Y coordinate (or longitude) of the ARP position, depending on flags above. Must be in the range -99..+99. The precise WGS84 ECEF Y coordinate in units of cm, or the precise WGS84 ECEF longitude in units of 1e-7 degrees, is given by ecefYOrLon + (ecefYOrLonHP * 1e-2)	
18	I1	-	ecefZOrAltHP	0.1_mm	High-precision WGS84 ECEF Z coordinate (or altitude) of the ARP position, depending on flags above. Must be in the range -99..+99. The precise WGS84 ECEF Z coordinate, or altitude coordinate, in units of cm is given by ecefZOrAlt + (ecefZOrAltHP * 1e-2)	

CFG-TMODE3 continued

Byte Offset	Number Format	Scaling	Name	Unit	Description
19	U1	-	reserved2	-	Reserved
20	U4	-	fixedPosAcc	0.1_mm	Fixed position 3D accuracy
24	U4	-	svinMinDur	s	Survey-in minimum duration
28	U4	-	svinAccLimit	0.1_mm	Survey-in position accuracy limit
32	U1[8]	-	reserved3	-	Reserved

Bitfield flags

This graphic explains the bits of flags

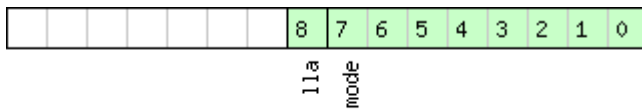

- signed value
- unsigned value
- reserved

Name	Description
mode	Receiver Mode: 0 Disabled 1 Survey In 2 Fixed Mode (true ARP position information required) 3-255 Reserved
11a	Position is given in LAT/LON/ALT (default is ECEF)

31.11.32 UBX-CFG-TP5 (0x06 0x31)

31.11.32.1 Poll Time Pulse Parameters for Time Pulse 0

Message	CFG-TP5					
Description	Poll Time Pulse Parameters for Time Pulse 0					
Firmware	Supported on: <ul style="list-style-type: none"> • u-blox 8 / u-blox M8 from protocol version 15 up to version 22 					
Type	Poll Request					
Comment	Sending this (empty / no-payload) message to the receiver results in the receiver returning a message of type CFG-TP5 with a payload as defined below for timepulse 0.					
Message Structure	Header	Class	ID	Length (Bytes)	Payload	Checksum
	0xB5 0x62	0x06	0x31	0	see below	CK_A CK_B
No payload						

31.11.32.2 Poll Time Pulse Parameters

Message		CFG-TP5					
Description		Poll Time Pulse Parameters					
Firmware		Supported on: <ul style="list-style-type: none"> • u-blox 8 / u-blox M8 from protocol version 15 up to version 22 					
Type		Poll Request					
Comment		Sending this message to the receiver results in the receiver returning a message of type CFG-TP5 with a payload as defined below for the specified time pulse.					
Message Structure		Header	Class	ID	Length (Bytes)	Payload	Checksum
		0xB5 0x62	0x06	0x31	1	see below	CK_A CK_B
Payload Contents:							
Byte Offset	Number Format	Scaling	Name	Unit	Description		
0	U1	-	tpIdx	-	Time pulse selection (0 = TIMEPULSE, 1 = TIMEPULSE2)		

31.11.32.3 Time Pulse Parameters

Message		CFG-TP5					
Description		Time Pulse Parameters					
Firmware		Supported on: <ul style="list-style-type: none"> • u-blox 8 / u-blox M8 with protocol version 15 					
Type		Get/Set					
Comment		This message is used to get/set time pulse parameters. For more information see section Time pulse .					
Message Structure		Header	Class	ID	Length (Bytes)	Payload	Checksum
		0xB5 0x62	0x06	0x31	32	see below	CK_A CK_B
Payload Contents:							
Byte Offset	Number Format	Scaling	Name	Unit	Description		
0	U1	-	tpIdx	-	Time pulse selection (0 = TIMEPULSE, 1 = TIMEPULSE2)		
1	U1	-	version	-	Message version (0x00 for this version)		
2	U1[2]	-	reserved1	-	Reserved		
4	I2	-	antCableDelay	ns	Antenna cable delay		
6	I2	-	rfGroupDelay	ns	RF group delay		
8	U4	-	freqPeriod	Hz_or_us	Frequency or period time, depending on setting of bit 'isFreq'		
12	U4	-	freqPeriodLock	Hz_or_us	Frequency or period time when locked to GPS time, only used if 'lockedOtherSet' is set		
16	U4	-	pulseLenRatio	us_or_2^-32	Pulse length or duty cycle, depending on 'isLength'		
20	U4	-	pulseLenRatioLock	us_or_2^-32	Pulse length or duty cycle when locked to GPS time, only used if 'lockedOtherSet' is set		
24	I4	-	userConfigDelay	ns	User configurable time pulse delay		

CFG-TP5 continued

Byte Offset	Number Format	Scaling	Name	Unit	Description
28	X4	-	flags	-	Configuration flags (see graphic below)

Bitfield flags

This graphic explains the bits of flags

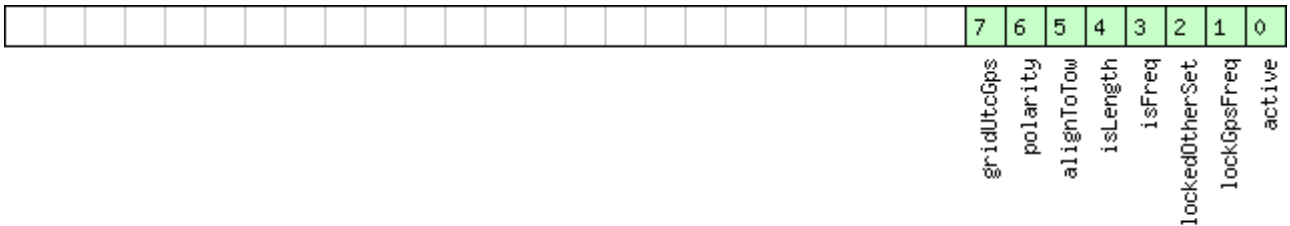

- signed value
- unsigned value
- reserved

Name	Description
active	if set enable time pulse; if pin assigned to another function, other function takes precedence
lockGpsFreq	if set synchronize time pulse to GPS as soon as GPS time is valid, otherwise use local clock
lockedOtherSet	if set use 'freqPeriodLock' and 'pulseLenRatioLock' as soon as GPS time is valid and 'freqPeriod' and 'pulseLenRatio' if GPS time is invalid, if flag is cleared 'freqPeriod' and 'pulseLenRatio' used regardless of GPS time
isFreq	if set 'freqPeriodLock' and 'freqPeriod' interpreted as frequency, otherwise interpreted as period
isLength	if set 'pulseLenRatioLock' and 'pulseLenRatio' interpreted as pulse length, otherwise interpreted as duty cycle
alignToTow	align pulse to top of second (period time must be integer fraction of 1s)
polarity	pulse polarity: 0 = falling edge at top of second 1 = rising edge at top of second
gridUtcGps	timegrid to use: 0 = UTC 1 = GPS

31.11.32.4 Time Pulse Parameters

Message	CFG-TP5					
Description	Time Pulse Parameters					
Firmware	Supported on: <ul style="list-style-type: none"> • u-blox 8 / u-blox M8 from protocol version 16 up to version 22 					
Type	Get/Set					
Comment	This message is used to get/set time pulse parameters. For more information see section Time pulse .					
Message Structure	Header	Class	ID	Length (Bytes)	Payload	Checksum
	0xB5 0x62	0x06	0x31	32	see below	CK_A CK_B
Payload Contents:						
Byte Offset	Number Format	Scaling	Name	Unit	Description	
0	U1	-	tpIdx	-	Time pulse selection (0 = TIMEPULSE, 1 = TIMEPULSE2)	

CFG-TP5 continued

Byte Offset	Number Format	Scaling	Name	Unit	Description
1	U1	-	version	-	Message version (0x01 for this version)
2	U1[2]	-	reserved1	-	Reserved
4	I2	-	antCableDelay	ns	Antenna cable delay
6	I2	-	rfGroupDelay	ns	RF group delay
8	U4	-	freqPeriod	Hz_or_us	Frequency or period time, depending on setting of bit 'isFreq'
12	U4	-	freqPeriodLock	Hz_or_us	Frequency or period time when locked to GNSS time, only used if 'lockedOtherSet' is set
16	U4	-	pulseLenRatio	us_or_2^-32	Pulse length or duty cycle, depending on 'isLength'
20	U4	-	pulseLenRatioLock	us_or_2^-32	Pulse length or duty cycle when locked to GNSS time, only used if 'lockedOtherSet' is set
24	I4	-	userConfigDelay	ns	User configurable time pulse delay
28	X4	-	flags	-	Configuration flags (see graphic below)

Bitfield flags

This graphic explains the bits of flags

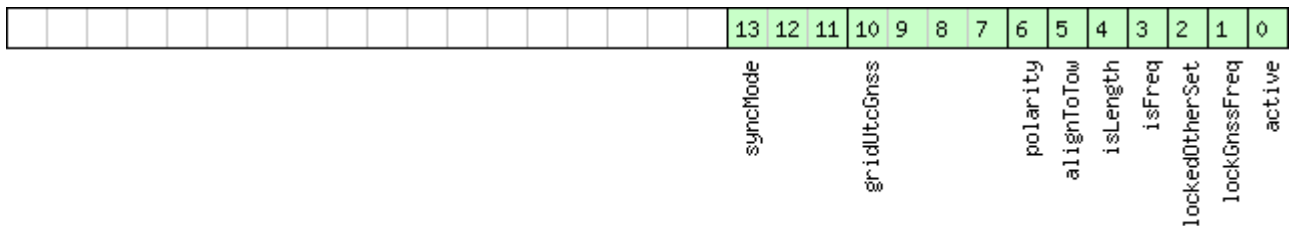

- signed value
- unsigned value
- reserved

Name	Description
active	If set enable time pulse; if pin assigned to another function, other function takes precedence. Must be set for FTS variant.
lockGnssFreq	If set synchronize time pulse to GNSS as soon as GNSS time is valid. If not set, or before GNSS time is valid use local clock. This flag is ignored by the FTS product variant; in this case the receiver always locks to the best available time/frequency reference (which is not necessarily GNSS).
lockedOtherSet	If set the receiver switches between the timepulse settings given by 'freqPeriodLocked' & 'pulseLenLocked' and those given by 'freqPeriod' & 'pulseLen'. The 'Locked' settings are used where the receiver has an accurate sense of time. For non-FTS products, this occurs when GNSS solution with a reliable time is available, but for FTS products the setting syncMode field governs behavior. In all cases, the receiver only uses 'freqPeriod' & 'pulseLen' when the flag is unset.
isFreq	If set 'freqPeriodLock' and 'freqPeriod' are interpreted as frequency, otherwise interpreted as period.
isLength	If set 'pulseLenRatiolock' and 'pulseLenRatio' interpreted as pulse length, otherwise interpreted as duty cycle.
alignToTow	Align pulse to top of second (period time must be integer fraction of 1s). Also set 'lockGnssFreq' to use this feature. This flag is ignored by the FTS product variant; it is assumed to be always set (as is lockGnssFreq). Set maxSlewRate and maxPhaseCorrRate fields of CFG-SMGR to 0 to disable alignment.

Bitfield flags Description continued

Name	Description
polarity	Pulse polarity: 0: falling edge at top of second 1: rising edge at top of second
gridUtcGnss	Timegrid to use: 0: UTC 1: GPS 2: GLONASS 3: BeiDou 4: Galileo (not supported in protocol versions less than 18) This flag is only relevant if 'lockGnssFreq' and 'alignToTow' are set. Note that configured GNSS time is estimated by the receiver if locked to any GNSS system. If the receiver has a valid GNSS fix it will attempt to steer the TP to the specified time grid even if the specified time is not based on information from the constellation's satellites. To ensure timing based purely on a given GNSS, restrict the supported constellations in CFG-GNSS .
syncMode	Sync Manager lock mode to use: 0: switch to 'freqPeriodLock' and 'pulseLenRatioLock' as soon as Sync Manager has an accurate time, never switch back to 'freqPeriod' and 'pulseLenRatio' 1: switch to 'freqPeriodLock' and 'pulseLenRatioLock' as soon as Sync Manager has an accurate time, and switch back to 'freqPeriod' and 'pulseLenRatio' as soon as time gets inaccurate This field is only relevant for the FTS product variant. This field is only relevant if the flag 'lockedOtherSet' is set.

31.11.33 UBX-CFG-TXSLOT (0x06 0x53)

31.11.33.1 TX buffer time slots configuration

Message	CFG-TXSLOT					
Description	TX buffer time slots configuration					
Firmware	Supported on: <ul style="list-style-type: none"> u-blox 8 / u-blox M8 from protocol version 16 up to version 23.01 (only with Time & Frequency Sync products) 					
Type	Set					
Comment	This message configures how transmit time slots are defined for the receiver interfaces. These time slots are relative to the chosen time pulse. A receiver that supports this message offers 3 time slots: nr. 0, 1 and 2. These time pulses follow each other and their associated priorities decrease in this order. The end of each can be specified in this message, the beginning is when the circularly previous slot ends (i.e. slot 0 starts when slot 2 finishes).					
Message Structure	Header	Class	ID	Length (Bytes)	Payload	Checksum
	0xB5 0x62	0x06	0x53	16	see below	CK_A CK_B
Payload Contents:						
Byte Offset	Number Format	Scaling	Name	Unit	Description	
0	U1	-	version	-	Message version (0 for this version)	
1	X1	-	enable	-	Bitfield of ports for which the slots are enabled. (see graphic below)	

CFG-TXSLOT continued

Byte Offset	Number Format	Scaling	Name	Unit	Description
2	U1	-	refTp	-	Reference timepulse source 0 - Timepulse 1 - Timepulse 2
3	U1	-	reserved1	-	Reserved
<i>Start of repeated block (3 times)</i>					
4 + 4*N	U4	-	end	-	End of timeslot in milliseconds after time pulse
<i>End of repeated block</i>					

Bitfield enable

This graphic explains the bits of enable

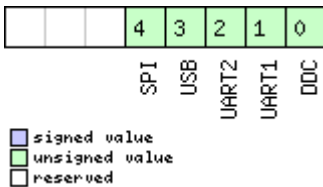

Name	Description
DDC	DDC/I2C
UART1	UART 1
UART2	UART 2
USB	USB
SPI	SPI

31.11.34 UBX-CFG-USB (0x06 0x1B)

31.11.34.1 USB Configuration

Message	CFG-USB					
Description	USB Configuration					
Firmware	Supported on: <ul style="list-style-type: none"> u-blox 8 / u-blox M8 from protocol version 15 up to version 23.01 					
Type	Get/Set					
Comment	-					
Message Structure	Header	Class	ID	Length (Bytes)	Payload	Checksum
	0xB5 0x62	0x06	0x1B	108	see below	CK_A CK_B
<i>Payload Contents:</i>						
Byte Offset	Number Format	Scaling	Name	Unit	Description	
0	U2	-	vendorID	-	Vendor ID. This field shall only be set to registered Vendor IDs. Changing this field requires special Host drivers.	
2	U2	-	productID	-	Product ID. Changing this field requires special Host drivers.	
4	U1[2]	-	reserved1	-	Reserved	
6	U1[2]	-	reserved2	-	Reserved	

CFG-USB continued

Byte Offset	Number Format	Scaling	Name	Unit	Description
8	U2	-	powerConsumption	mA	Power consumed by the device
10	X2	-	flags	-	various configuration flags (see graphic below)
12	CH[32]	-	vendorString	-	String containing the vendor name. 32 ASCII bytes including 0-termination.
44	CH[32]	-	productString	-	String containing the product name. 32 ASCII bytes including 0-termination.
76	CH[32]	-	serialNumber	-	String containing the serial number. 32 ASCII bytes including 0-termination. Changing the String fields requires special Host drivers.

Bitfield flags

This graphic explains the bits of flags

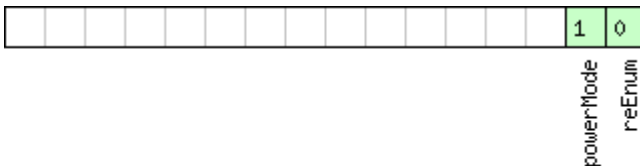

- signed value
- unsigned value
- reserved

Name	Description
reEnum	force re-enumeration
powerMode	self-powered (1), bus-powered (0)

Bitfield bitfield0 Description continued

Name	Description
<i>Name</i>	<i>Description</i>
version	Message version (1 for this version).
xAngRateValid	Compensated x-axis angular rate data validity flag (0: not valid, 1: valid).
yAngRateValid	Compensated y-axis angular rate data validity flag (0: not valid, 1: valid).
zAngRateValid	Compensated z-axis angular rate data validity flag (0: not valid, 1: valid).
xAccelValid	Compensated x-axis acceleration data validity flag (0: not valid, 1: valid).
yAccelValid	Compensated y-axis acceleration data validity flag (0: not valid, 1: valid).
zAccelValid	Compensated z-axis acceleration data validity flag (0: not valid, 1: valid).

31.12.2 UBX-ESF-MEAS (0x10 0x02)
31.12.2.1 External Sensor Fusion Measurements

Message	ESF-MEAS					
Description	External Sensor Fusion Measurements					
Firmware	Supported on: <ul style="list-style-type: none"> • u-blox 8 / u-blox M8 from protocol version 15.01 up to version 17 (only with ADR products) • u-blox 8 / u-blox M8 from protocol version 19 up to version 23.01 (only with ADR or UDR products) 					
Type	Input/Output					
Comment	Possible data types for the data field are described in the ESF Measurement Data section.					
Message Structure	Header	Class	ID	Length (Bytes)	Payload	Checksum
	0xB5 0x62	0x10	0x02	(8 + 4*N) or (12 + 4*N)	see below	CK_A CK_B
Payload Contents:						
Byte Offset	Number Format	Scaling	Name	Unit	Description	
0	U4	-	timeTag	-	Time tag of measurement generated by external sensor	
4	X2	-	flags	-	Flags. Set all unused bits to zero. (see graphic below)	
6	U2	-	id	-	Identification number of data provider	
Start of repeated block (N times)						
8 + 4*N	X4	-	data	-	data (see graphic below)	
End of repeated block						
Start of optional block						
8 + 4*N	U4	-	calibTtag	ms	Receiver local time calibrated. This field must not be supplied when calibTtagValid is set to 0.	
End of optional block						

Bitfield flags

This graphic explains the bits of flags

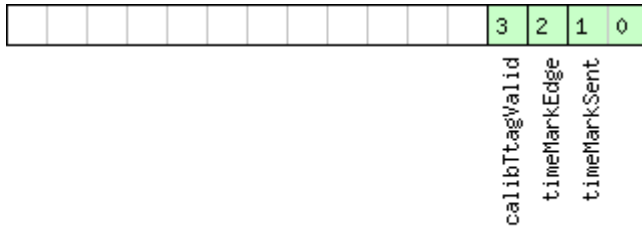

signed value
 unsigned value
 reserved

Name	Description
timeMarkSent	Time mark signal was supplied just prior to sending this message: 0 = none, 1 = on Ext0, 2 = on Ext1
timeMarkEdge	Trigger on rising (0) or falling (1) edge of time mark signal
calibTtagValid	Calibration time tag available. Always set to zero.

Bitfield data

This graphic explains the bits of data

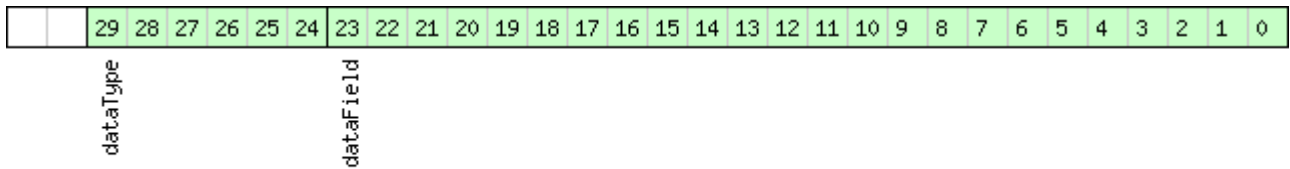

signed value
 unsigned value
 reserved

Name	Description
dataField	Data
dataType	Type of data (0 = no data; 1..63 = data type)

31.12.3 UBX-ESF-RAW (0x10 0x03)

31.12.3.1 Raw sensor measurements

Message	ESF-RAW					
Description	Raw sensor measurements					
Firmware	Supported on: <ul style="list-style-type: none"> • u-blox 8 / u-blox M8 from protocol version 15.01 up to version 17 (only with ADR products) • u-blox 8 / u-blox M8 from protocol version 19 up to version 23.01 (only with UDR or ADR products) 					
Type	Output					
Comment	The message contains measurements from the active inertial sensors connected to the GNSS chip. Possible data types for the data field are accelerometer, gyroscope and temperature readings as described in the ESF Measurement Data section. Note that the rate selected in CFG-MSG is not respected. If a positive rate is selected then all raw measurements will be output. See also Raw Sensor Measurement Data .					
Message Structure	Header	Class	ID	Length (Bytes)	Payload	Checksum
	0xB5 0x62	0x10	0x03	4 + 8*N	see below	CK_A CK_B

Payload Contents:					
Byte Offset	Number Format	Scaling	Name	Unit	Description
0	U1[4]	-	reserved1	-	Reserved
Start of repeated block (N times)					
4 + 8*N	X4	-	data	-	data Its scaling and unit depends on the type and is the same as in ESF-MEAS (see graphic below)
8 + 8*N	U4	-	sTtag	-	sensor time tag
End of repeated block					

Bitfield data

This graphic explains the bits of data

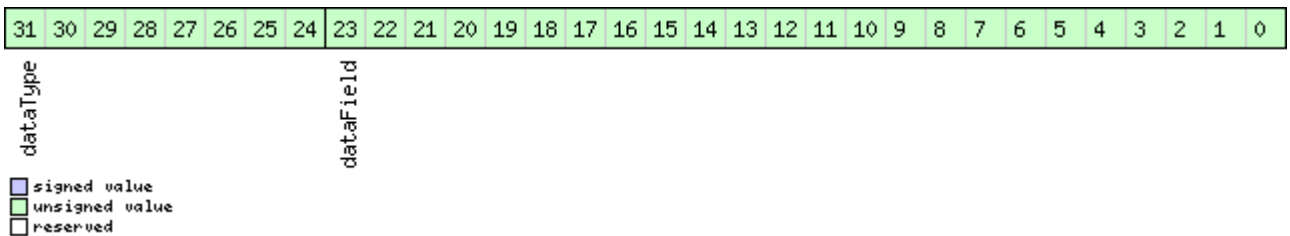

Name	Description
dataField	data
dataType	type of data (0 = no data; 1..255 = data type)

31.12.4 UBX-ESF-STATUS (0x10 0x10)

31.12.4.1 External Sensor Fusion (ESF) status information

Message	ESF-STATUS					
Description	External Sensor Fusion (ESF) status information					
Firmware	Supported on: <ul style="list-style-type: none"> u-blox 8 / u-blox M8 from protocol version 15.01 up to version 17 (only with ADR products) u-blox 8 / u-blox M8 from protocol version 19 up to version 23.01 (only with UDR or ADR products) 					
Type	Periodic/Polled					
Comment	-					
Message Structure	Header	Class	ID	Length (Bytes)	Payload	Checksum
	0xB5 0x62	0x10	0x10	16 + 4*numSens	see below	CK_A CK_B
Payload Contents:						
Byte Offset	Number Format	Scaling	Name	Unit	Description	
0	U4	-	iTOW	ms	GPS time of week of the navigation epoch . See the description of iTOW for details.	
4	U1	-	version	-	Message version (2 for this version)	
5	U1[7]	-	reserved1	-	Reserved	

ESF-STATUS continued

Byte Offset	Number Format	Scaling	Name	Unit	Description
12	U1	-	fusionMode	-	Fusion mode: 0: Initialization mode: receiver is initializing some unknown values required for doing sensor fusion 1: Fusion mode: GNSS and sensor data are used for navigation solution computation 2: Suspended fusion mode: sensor fusion is temporarily disabled due to e.g. invalid sensor data or detected ferry 3: Disabled fusion mode: sensor fusion is permanently disabled until receiver reset due e. g. to sensor error More details can be found in the Fusion Modes section.
13	U1[2]	-	reserved2	-	Reserved
15	U1	-	numSens	-	Number of sensors
<i>Start of repeated block (numSens times)</i>					
16 + 4*N	X1	-	sensStatus1	-	Sensor status, part 1 (see graphic below)
17 + 4*N	X1	-	sensStatus2	-	Sensor status, part 2 (see graphic below)
18 + 4*N	U1	-	freq	Hz	Observation frequency
19 + 4*N	X1	-	faults	-	Sensor faults (see graphic below)
<i>End of repeated block</i>					

Bitfield sensStatus1

This graphic explains the bits of `sensStatus1`

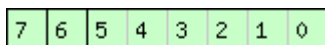

Name	Description
type	Sensor data type. Data types are defined in the Sensor Data Types section.
used	If set, sensor data is used for the current sensor fusion solution.
ready	If set, sensor is set up (configuration is available or not required) but not used for computing the current sensor fusion solution.

Bitfield sensStatus2

This graphic explains the bits of `sensStatus2`

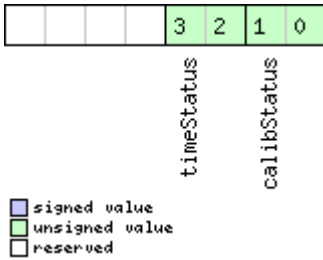

Name	Description
<code>calibStatus</code>	00: Sensor is not calibrated 01: Sensor is calibrating 10/11: Sensor is calibrated Good dead reckoning performance is only possible when all used sensors are calibrated. Depending on the quality of the GNSS signals and the sensor data, the sensors may take a longer time to get calibrated.
<code>timeStatus</code>	00: No data 01: Reception of the first byte used to tag the measurement 10: Event input used to tag the measurement 11: Time tag provided with the data

Bitfield faults

This graphic explains the bits of `faults`

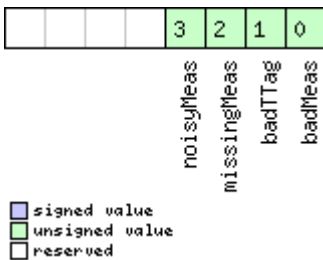

Name	Description
<code>badMeas</code>	Bad measurements detected
<code>badTTag</code>	Bad measurement time-tags detected
<code>missingMeas</code>	Missing or time-misaligned measurements detected
<code>noisyMeas</code>	High measurement noise-level detected

31.13 UBX-HNR (0x28)

High Rate Navigation Results Messages: i.e. High rate time, position, speed, heading.

Messages in the HNR class are used to output high rate navigation data for position, altitude, velocity and their accuracies.

31.13.1 UBX-HNR-PVT (0x28 0x00)

31.13.1.1 High Rate Output of PVT Solution

Message	HNR-PVT					
Description	High Rate Output of PVT Solution					
Firmware	Supported on: <ul style="list-style-type: none"> • u-blox 8 / u-blox M8 from protocol version 19 up to version 23.01 (only with ADR or UDR products) 					
Type	Periodic/Polled					
Comment	Note that during a leap second there may be more (or less) than 60 seconds in a minute; see the description of leap seconds for details. This message provides the position, velocity and time solution with high output rate.					
Message Structure	Header	Class	ID	Length (Bytes)	Payload	Checksum
	0xB5 0x62	0x28	0x00	72	see below	CK_A CK_B
Payload Contents:						
Byte Offset	Number Format	Scaling	Name	Unit	Description	
0	U4	-	iTOW	ms	GPS time of week of the navigation epoch . See the description of iTOW for details.	
4	U2	-	year	y	Year (UTC)	
6	U1	-	month	month	Month, range 1..12 (UTC)	
7	U1	-	day	d	Day of month, range 1..31 (UTC)	
8	U1	-	hour	h	Hour of day, range 0..23 (UTC)	
9	U1	-	min	min	Minute of hour, range 0..59 (UTC)	
10	U1	-	sec	s	Seconds of minute, range 0..60 (UTC)	
11	X1	-	valid	-	Validity Flags (see graphic below)	
12	I4	-	nano	ns	Fraction of second, range -1e9 .. 1e9 (UTC)	
16	U1	-	gpsFix	-	GPSfix Type, range 0..5 0x00 = No Fix 0x01 = Dead Reckoning only 0x02 = 2D-Fix 0x03 = 3D-Fix 0x04 = GPS + dead reckoning combined 0x05 = Time only fix 0x06..0xff: reserved	
17	X1	-	flags	-	Fix Status Flags (see graphic below)	
18	U1[2]	-	reserved1	-	Reserved	
20	I4	1e-7	lon	deg	Longitude	
24	I4	1e-7	lat	deg	Latitude	
28	I4	-	height	mm	Height above Ellipsoid	
32	I4	-	hMSL	mm	Height above mean sea level	
36	I4	-	gSpeed	mm/s	Ground Speed (2-D)	

HNR-PVT continued

Byte Offset	Number Format	Scaling	Name	Unit	Description
40	I4	-	speed	mm/s	Speed (3-D)
44	I4	1e-5	headMot	deg	Heading of motion (2-D)
48	I4	1e-5	headVeh	deg	Heading of vehicle (2-D)
52	U4	-	hAcc	mm	Horizontal accuracy
56	U4	-	vAcc	mm	Vertical accuracy
60	U4	-	sAcc	mm/s	Speed accuracy
64	U4	1e-5	headAcc	deg	Heading accuracy
68	U1[4]	-	reserved2	-	Reserved

Bitfield valid

This graphic explains the bits of valid

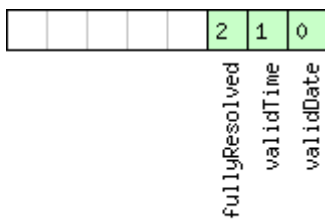

signed value
 unsigned value
 reserved

Name	Description
validDate	1 = Valid UTC Date (see Time Validity section for details)
validTime	1 = Valid UTC Time of Day (see Time Validity section for details)
fullyResolved	1 = UTC Time of Day has been fully resolved (no seconds uncertainty)

Bitfield flags

This graphic explains the bits of flags

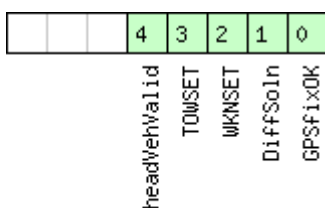

signed value
 unsigned value
 reserved

Name	Description
GPSfixOK	>1 = Fix within limits (e.g. DOP & accuracy)
DiffSoln	1 = DGPS used
WKNSET	1 = Valid GPS week number
TOWSET	1 = Valid GPS time of week (iTOW & fTOW)
headVehValid	Heading of vehicle is valid

31.14 UBX-INF (0x04)

Information Messages: i.e. Printf-Style Messages, with IDs such as Error, Warning, Notice.

Messages in the INF class are used to output strings in a printf style from the firmware or application code. All INF messages have an associated type to indicate the kind of message.

31.14.1 UBX-INF-DEBUG (0x04 0x04)

31.14.1.1 ASCII output with debug contents

Message	INF-DEBUG					
Description	ASCII output with debug contents					
Firmware	Supported on: <ul style="list-style-type: none"> u-blox 8 / u-blox M8 from protocol version 15 up to version 23.01 					
Type	Output					
Comment	This message has a variable length payload, representing an ASCII string.					
Message Structure	Header	Class	ID	Length (Bytes)	Payload	Checksum
	0xB5 0x62	0x04	0x04	0 + 1*N	see below	CK_A CK_B
Payload Contents:						
Byte Offset	Number Format	Scaling	Name	Unit	Description	
Start of repeated block (N times)						
N*1	CH	-	str	-	ASCII Character	
End of repeated block						

31.14.2 UBX-INF-ERROR (0x04 0x00)

31.14.2.1 ASCII output with error contents

Message	INF-ERROR					
Description	ASCII output with error contents					
Firmware	Supported on: <ul style="list-style-type: none"> u-blox 8 / u-blox M8 from protocol version 15 up to version 23.01 					
Type	Output					
Comment	This message has a variable length payload, representing an ASCII string.					
Message Structure	Header	Class	ID	Length (Bytes)	Payload	Checksum
	0xB5 0x62	0x04	0x00	0 + 1*N	see below	CK_A CK_B
Payload Contents:						
Byte Offset	Number Format	Scaling	Name	Unit	Description	
Start of repeated block (N times)						
N*1	CH	-	str	-	ASCII Character	
End of repeated block						

31.14.3 UBX-INF-NOTICE (0x04 0x02)

31.14.3.1 ASCII output with informational contents

Message	INF-NOTICE					
Description	ASCII output with informational contents					
Firmware	Supported on: <ul style="list-style-type: none"> u-blox 8 / u-blox M8 from protocol version 15 up to version 23.01 					
Type	Output					
Comment	This message has a variable length payload, representing an ASCII string.					
Message Structure	Header	Class	ID	Length (Bytes)	Payload	Checksum
	0xB5 0x62	0x04	0x02	0 + 1*N	see below	CK_A CK_B
Payload Contents:						
Byte Offset	Number Format	Scaling	Name	Unit	Description	
Start of repeated block (N times)						
N*1	CH	-	str	-	ASCII Character	
End of repeated block						

31.14.4 UBX-INF-TEST (0x04 0x03)

31.14.4.1 ASCII output with test contents

Message	INF-TEST					
Description	ASCII output with test contents					
Firmware	Supported on: <ul style="list-style-type: none"> u-blox 8 / u-blox M8 from protocol version 15 up to version 23.01 					
Type	Output					
Comment	This message has a variable length payload, representing an ASCII string.					
Message Structure	Header	Class	ID	Length (Bytes)	Payload	Checksum
	0xB5 0x62	0x04	0x03	0 + 1*N	see below	CK_A CK_B
Payload Contents:						
Byte Offset	Number Format	Scaling	Name	Unit	Description	
Start of repeated block (N times)						
N*1	CH	-	str	-	ASCII Character	
End of repeated block						

31.14.5 UBX-INF-WARNING (0x04 0x01)

31.14.5.1 ASCII output with warning contents

<i>Message</i>	INF-WARNING					
<i>Description</i>	ASCII output with warning contents					
<i>Firmware</i>	Supported on: <ul style="list-style-type: none"> u-blox 8 / u-blox M8 from protocol version 15 up to version 23.01 					
<i>Type</i>	Output					
<i>Comment</i>	This message has a variable length payload, representing an ASCII string.					
<i>Message Structure</i>	<i>Header</i>	<i>Class</i>	<i>ID</i>	<i>Length (Bytes)</i>	<i>Payload</i>	<i>Checksum</i>
	0xB5 0x62	0x04	0x01	0 + 1*N	see below	CK_A CK_B
<i>Payload Contents:</i>						
<i>Byte Offset</i>	<i>Number Format</i>	<i>Scaling</i>	<i>Name</i>	<i>Unit</i>	<i>Description</i>	
<i>Start of repeated block (N times)</i>						
N*1	CH	-	str	-	ASCII Character	
<i>End of repeated block</i>						

31.15 UBX-LOG (0x21)

Logging Messages: i.e. Log creation, deletion, info and retrieval.

Messages in the LOG class are used to configure and report status information of the logging and batching features.

31.15.1 UBX-LOG-CREATE (0x21 0x07)

31.15.1.1 Create Log File

Message	LOG-CREATE					
Description	Create Log File					
Firmware	Supported on: <ul style="list-style-type: none"> u-blox 8 / u-blox M8 from protocol version 15 up to version 23.01 					
Type	Command					
Comment	This message is used to create an initial logging file and activate the logging subsystem. UBX-ACK-ACK or UBX-ACK-NAK are returned to indicate success or failure. This message does not handle activation of recording or filtering of log entries (see UBX-CFG-LOGFILTER).					
Message Structure	Header	Class	ID	Length (Bytes)	Payload	Checksum
	0xB5 0x62	0x21	0x07	8	see below	CK_A CK_B
Payload Contents:						
Byte Offset	Number Format	Scaling	Name	Unit	Description	
0	U1	-	version	-	The version of this message. Set to 0	
1	X1	-	logCfg	-	Config flags (see graphic below)	
2	U1	-	reserved1	-	Reserved	
3	U1	-	logSize	-	Indicates the size of the log: 0 (maximum safe size): Ensures that logging will not be interrupted and enough space will be left available for all other uses of the filestore 1 (minimum size): 2 (user defined): See 'userDefinedSize' below	
4	U4	-	userDefinedSize	bytes	Sets the maximum amount of space in the filestore that can be used by the logging task. This field is only applicable if logSize is set to user defined.	

Bitfield logCfg

This graphic explains the bits of logCfg

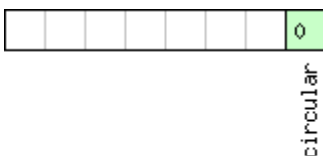

- signed value
- unsigned value
- reserved

Name	Description
circular	Log is circular (new entries overwrite old ones in a full log) if this bit set

31.15.2 UBX-LOG-ERASE (0x21 0x03)

31.15.2.1 Erase Logged Data

Message	LOG-ERASE					
Description	Erase Logged Data					
Firmware	Supported on: <ul style="list-style-type: none"> u-blox 8 / u-blox M8 from protocol version 15 up to version 23.01 					
Type	Command					
Comment	This message deactivates the logging system and erases all logged data. UBX-ACK-ACK or UBX-ACK-NAK are returned to indicate success or failure.					
Message Structure	Header	Class	ID	Length (Bytes)	Payload	Checksum
	0xB5 0x62	0x21	0x03	0	see below	CK_A CK_B
No payload						

31.15.3 UBX-LOG-FINDTIME (0x21 0x0E)

31.15.3.1 Find index of a log entry based on a given time

Message	LOG-FINDTIME					
Description	Find index of a log entry based on a given time					
Firmware	Supported on: <ul style="list-style-type: none"> u-blox 8 / u-blox M8 from protocol version 15 up to version 23.01 					
Type	Input					
Comment	<p>This message can be used for a time-based search of a log. It can find the index of the first log entry with time equal to the given time, otherwise the index of the most recent entry with time less than the given time. This index can then be used with the UBX-LOG-RETRIEVE message to provide time-based retrieval of log entries.</p> <p>Searching a log is effective for a given time later than the base date (January 1st, 2004). Searching a log for a given time earlier than the base date will result in an 'entry not found' response. (Searching a log for a given time earlier than the base date will result in a UBX-ACK-NAK message in protocol versions less than 18)</p> <p>Searching a log for a given time greater than the last recorded entry's time will return the index of the last recorded entry. (If the logging has stopped due to lack of file space, such a search will result in a UBX-ACK-NAK message in protocol versions less than 18)</p>					
Message Structure	Header	Class	ID	Length (Bytes)	Payload	Checksum
	0xB5 0x62	0x21	0x0E	12	see below	CK_A CK_B
Payload Contents:						
Byte Offset	Number Format	Scaling	Name	Unit	Description	
0	U1	-	version	-	Message version (=0 for this version)	
1	U1	-	type	-	Message type, 0 for request	
2	U1[2]	-	reserved1	-	Reserved	
4	U2	-	year	-	Year (1-65635) of UTC time	
6	U1	-	month	-	Month (1-12) of UTC time	
7	U1	-	day	-	Day (1-31) of UTC time	
8	U1	-	hour	-	Hour (0-23) of UTC time	
9	U1	-	minute	-	Minute (0-59) of UTC time	
10	U1	-	second	-	Second (0-60) of UTC time	

LOG-FINDTIME continued

Byte Offset	Number Format	Scaling	Name	Unit	Description
11	U1	-	reserved2	-	Reserved

31.15.3.2 Response to FINDTIME request.

Message	LOG-FINDTIME					
Description	Response to FINDTIME request.					
Firmware	Supported on: <ul style="list-style-type: none"> u-blox 8 / u-blox M8 from protocol version 15 up to version 23.01 					
Type	Output					
Comment	-					
Message Structure	Header	Class	ID	Length (Bytes)	Payload	Checksum
	0xB5 0x62	0x21	0x0E	8	see below	CK_A CK_B
Payload Contents:						
Byte Offset	Number Format	Scaling	Name	Unit	Description	
0	U1	-	version	-	Message version (=1 for this version)	
1	U1	-	type	-	Message type, 1 for response	
2	U1[2]	-	reserved1	-	Reserved	
4	U4	-	entryNumber	-	Index of the first log entry with time = given time, otherwise index of the most recent entry with time < given time. If 0xFFFFFFFF, no log entry found with time <= given time. The indexing of log entries is zero based.	

31.15.4 UBX-LOG-INFO (0x21 0x08)

31.15.4.1 Poll for log information

Message	LOG-INFO					
Description	Poll for log information					
Firmware	Supported on: <ul style="list-style-type: none"> u-blox 8 / u-blox M8 from protocol version 15 up to version 23.01 					
Type	Poll Request					
Comment	Upon sending of this message, the receiver returns UBX-LOG-INFO as defined below.					
Message Structure	Header	Class	ID	Length (Bytes)	Payload	Checksum
	0xB5 0x62	0x21	0x08	0	see below	CK_A CK_B
No payload						

31.15.4.2 Log information

Message	LOG-INFO					
Description	Log information					
Firmware	Supported on: <ul style="list-style-type: none"> u-blox 8 / u-blox M8 from protocol version 15 up to version 23.01 					
Type	Output					
Comment	This message is used to report information about the logging subsystem. Note: <ul style="list-style-type: none"> The reported maximum log size will be smaller than that originally specified in LOG-CREATE due to logging and filestore implementation overheads. Log entries are compressed in a variable length fashion, so it may be difficult to predict log space usage with any precision. There may be times when the receiver does not have an accurate time (e.g. if the week number is not yet known), in which case some entries will not have a timestamp. This may result in the oldest/newest entry time values not taking account of these entries. 					
Message Structure	Header	Class	ID	Length (Bytes)	Payload	Checksum
	0xB5 0x62	0x21	0x08	48	see below	CK_A CK_B
Payload Contents:						
Byte Offset	Number Format	Scaling	Name	Unit	Description	
0	U1	-	version	-	The version of this message. Set to 1	
1	U1[3]	-	reserved1	-	Reserved	
4	U4	-	filestoreCapacity	bytes	The capacity of the filestore	
8	U1[8]	-	reserved2	-	Reserved	
16	U4	-	currentMaxLogSize	bytes	The maximum size the current log is allowed to grow to	
20	U4	-	currentLogSize	bytes	Approximate amount of space in log currently occupied	
24	U4	-	entryCount	-	Number of entries in the log. Note: for circular logs this value will decrease when a group of entries is deleted to make space for new ones.	
28	U2	-	oldestYear	-	Oldest entry UTC year year (1-65635) or zero if there are no entries with known time	
30	U1	-	oldestMonth	-	Oldest month (1-12)	
31	U1	-	oldestDay	-	Oldest day (1-31)	
32	U1	-	oldestHour	-	Oldest hour (0-23)	
33	U1	-	oldestMinute	-	Oldest minute (0-59)	
34	U1	-	oldestSecond	-	Oldest second (0-60)	
35	U1	-	reserved3	-	Reserved	
36	U2	-	newestYear	-	Newest year (1-65635) or zero if there are no entries with known time	
38	U1	-	newestMonth	-	Newest month (1-12)	
39	U1	-	newestDay	-	Newest day (1-31)	
40	U1	-	newestHour	-	Newest hour (0-23)	

LOG-INFO continued

Byte Offset	Number Format	Scaling	Name	Unit	Description
41	U1	-	newestMinute	-	Newest minute (0-59)
42	U1	-	newestSecond	-	Newest second (0-60)
43	U1	-	reserved4	-	Reserved
44	X1	-	status	-	Log status flags (see graphic below)
45	U1[3]	-	reserved5	-	Reserved

Bitfield status

This graphic explains the bits of status

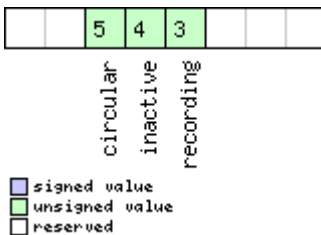

Name	Description
recording	Log entry recording is currently turned on
inactive	Logging system not active - no log present
circular	The current log is circular

31.15.5 UBX-LOG-RETRIEVEPOSEXTRA (0x21 0x0f)

31.15.5.1 Odometer log entry

Message	LOG-RETRIEVEPOSEXTRA					
Description	Odometer log entry					
Firmware	Supported on: <ul style="list-style-type: none"> u-blox 8 / u-blox M8 from protocol version 15 up to version 23.01 					
Type	Output					
Comment	This message is used to report an odometer log entry					
Message Structure	Header	Class	ID	Length (Bytes)	Payload	Checksum
	0xB5 0x62	0x21	0x0f	32	see below	CK_A CK_B

Payload Contents:

Byte Offset	Number Format	Scaling	Name	Unit	Description
0	U4	-	entryIndex	-	The index of this log entry
4	U1	-	version	-	The version of this message. Set to 0
5	U1	-	reserved1	-	Reserved
6	U2	-	year	-	Year (1-65635) of UTC time. Will be zero if time not known
8	U1	-	month	-	Month (1-12) of UTC time
9	U1	-	day	-	Day (1-31) of UTC time
10	U1	-	hour	-	Hour (0-23) of UTC time
11	U1	-	minute	-	Minute (0-59) of UTC time
12	U1	-	second	-	Second (0-60) of UTC time

LOG-RETRIEVEPOSEXTRA continued

Byte Offset	Number Format	Scaling	Name	Unit	Description
13	U1[3]	-	reserved2	-	Reserved
16	U4	-	distance	-	Odometer distance traveled since the last time the odometer was reset by a UBX-NAV-RESETODO
20	U1[12]	-	reserved3	-	Reserved

31.15.6 UBX-LOG-RETRIEVEPOS (0x21 0x0b)
31.15.6.1 Position fix log entry

Message	LOG-RETRIEVEPOS					
Description	Position fix log entry					
Firmware	Supported on: <ul style="list-style-type: none"> • u-blox 8 / u-blox M8 from protocol version 15 up to version 23.01 					
Type	Output					
Comment	This message is used to report a position fix log entry					
Message Structure	Header	Class	ID	Length (Bytes)	Payload	Checksum
	0xB5 0x62	0x21	0x0b	40	see below	CK_A CK_B
Payload Contents:						
Byte Offset	Number Format	Scaling	Name	Unit	Description	
0	U4	-	entryIndex	-	The index of this log entry	
4	I4	1e-7	lon	deg	Longitude	
8	I4	1e-7	lat	deg	Latitude	
12	I4	-	hMSL	mm	Height above mean sea level	
16	U4	-	hAcc	mm	Horizontal accuracy estimate	
20	U4	-	gSpeed	mm/s	Ground speed (2-D)	
24	U4	1e-5	heading	deg	Heading	
28	U1	-	version	-	The version of this message. Set to 0	
29	U1	-	fixType	-	Fix type: 0x01: Dead Reckoning only 0x02: 2D-Fix 0x03: 3D-Fix 0x04: GNSS + Dead Reckoning combined	
30	U2	-	year	-	Year (1-65635) of UTC time	
32	U1	-	month	-	Month (1-12) of UTC time	
33	U1	-	day	-	Day (1-31) of UTC time	
34	U1	-	hour	-	Hour (0-23) of UTC time	
35	U1	-	minute	-	Minute (0-59) of UTC time	
36	U1	-	second	-	Second (0-60) of UTC time	
37	U1	-	reserved1	-	Reserved	
38	U1	-	numSV	-	Number of satellites used in the position fix	
39	U1	-	reserved2	-	Reserved	

31.15.7 UBX-LOG-RETRIEVESTRING (0x21 0x0d)

31.15.7.1 Byte string log entry

Message	LOG-RETRIEVESTRING					
Description	Byte string log entry					
Firmware	Supported on: <ul style="list-style-type: none"> u-blox 8 / u-blox M8 from protocol version 15 up to version 23.01 					
Type	Output					
Comment	This message is used to report a byte string log entry					
Message Structure	Header	Class	ID	Length (Bytes)	Payload	Checksum
	0xB5 0x62	0x21	0x0d	16 + 1 *byteCount	see below	CK_A CK_B
Payload Contents:						
Byte Offset	Number Format	Scaling	Name	Unit	Description	
0	U4	-	entryIndex	-	The index of this log entry	
4	U1	-	version	-	The version of this message. Set to 0	
5	U1	-	reserved1	-	Reserved	
6	U2	-	year	-	Year (1-65635) of UTC time. Will be zero if time not known	
8	U1	-	month	-	Month (1-12) of UTC time	
9	U1	-	day	-	Day (1-31) of UTC time	
10	U1	-	hour	-	Hour (0-23) of UTC time	
11	U1	-	minute	-	Minute (0-59) of UTC time	
12	U1	-	second	-	Second (0-60) of UTC time	
13	U1	-	reserved2	-	Reserved	
14	U2	-	byteCount	-	Size of string in bytes	
Start of repeated block (byteCount times)						
16 + 1 *N	U1	-	bytes	-	The bytes of the string	
End of repeated block						

31.15.8 UBX-LOG-RETRIEVE (0x21 0x09)

31.15.8.1 Request log data

Message	LOG-RETRIEVE
Description	Request log data
Firmware	Supported on: <ul style="list-style-type: none"> u-blox 8 / u-blox M8 from protocol version 15 up to version 23.01
Type	Command
Comment	<p>This message is used to request logged data (log recording must first be disabled, see UBX-CFG-LOGFILTER).</p> <p>Log entries are returned in chronological order, using the messages UBX-LOG-RETRIEVEPOS and UBX-LOG-RETRIEVESTRING. If the odometer was enabled at the time a position was logged, then message UBX-LOG-RETRIEVEPOSEXTRA will also be used. The maximum number of entries that can be returned in response to a single UBX-LOG-RETRIEVE message is 256. If more entries than this are required the message will need to be sent multiple times with different startNumbers. The retrieve will be stopped if any UBX-LOG message is received. The speed of transfer can be maximized</p>

	by using a high data rate and temporarily stopping the GPS processing (see UBX-CFG-RST).					
Message Structure	Header	Class	ID	Length (Bytes)	Payload	Checksum
	0xB5 0x62	0x21	0x09	12	see below	CK_A CK_B
Payload Contents:						
Byte Offset	Number Format	Scaling	Name	Unit	Description	
0	U4	-	startNumber	-	Index of first log entry to be transferred. If it is larger than the index of the last available log entry, then the first log entry to be transferred is the last available log entry. The indexing of log entries is zero based.	
4	U4	-	entryCount	-	Number of log entries to transfer in total including the first entry to be transferred. If it is larger than the log entries available starting from the first entry to be transferred, then only the available log entries are transferred followed by a UBX-ACK-NAK . The maximum is 256.	
8	U1	-	version	-	The version of this message. Set to 0.	
9	U1[3]	-	reserved1	-	Reserved	

31.15.9 UBX-LOG-STRING (0x21 0x04)

31.15.9.1 Store arbitrary string in on-board flash

Message	LOG-STRING					
Description	Store arbitrary string in on-board flash					
Firmware	Supported on: <ul style="list-style-type: none"> • u-blox 8 / u-blox M8 from protocol version 15 up to version 23.01 					
Type	Command					
Comment	This message can be used to store an arbitrary byte string in the on-board flash memory. The maximum length that can be stored is 256 bytes.					
Message Structure	Header	Class	ID	Length (Bytes)	Payload	Checksum
	0xB5 0x62	0x21	0x04	0 + 1*N	see below	CK_A CK_B
Payload Contents:						
Byte Offset	Number Format	Scaling	Name	Unit	Description	
<i>Start of repeated block (N times)</i>						
N*1	U1	-	bytes	-	The string of bytes to be logged (maximum 256)	
<i>End of repeated block</i>						

31.16 UBX-MGA (0x13)

Multiple GNSS Assistance Messages: i.e. Assistance data for various GNSS.

Messages in the MGA class are used for GNSS aiding information from and to the receiver.

31.16.1 UBX-MGA-ACK (0x13 0x60)

31.16.1.1 UBX-MGA-ACK-DATA0

Message		UBX-MGA-ACK-DATA0					
Description		Multiple GNSS Acknowledge message					
Firmware		Supported on: <ul style="list-style-type: none"> u-blox 8 / u-blox M8 from protocol version 15 up to version 23.01 					
Type		Output					
Comment		This message is sent by a u-blox receiver to acknowledge the receipt of an assistance message. Acknowledgments are enabled by setting the ackAiding parameter in the UBX-CFG-NAVX5 message. See the description of flow control for details.					
Message Structure		Header	Class	ID	Length (Bytes)	Payload	Checksum
		0xB5 0x62	0x13	0x60	8	see below	CK_A CK_B
Payload Contents:							
Byte Offset	Number Format	Scaling	Name	Unit	Description		
0	U1	-	type	-	Type of acknowledgment: 0: The message was not used by the receiver (see infoCode field for an indication of why) 1: The message was accepted for use by the receiver (the infoCode field will be 0)		
1	U1	-	version	-	Message version (0x00 for this version)		
2	U1	-	infoCode	-	Provides greater information on what the receiver chose to do with the message contents: 0: The receiver accepted the data 1: The receiver doesn't know the time so can't use the data (To resolve this a UBX-MGA-INI-TIME_UTC message should be supplied first) 2: The message version is not supported by the receiver 3: The message size does not match the message version 4: The message data could not be stored to the database 5: The receiver is not ready to use the message data 6: The message type is unknown		
3	U1	-	msgId	-	UBX message ID of the ack'ed message		
4	U1[4]	-	msgPayloadStart	-	The first 4 bytes of the ack'ed message's payload		

31.16.2 UBX-MGA-ANO (0x13 0x20)

31.16.2.1 Multiple GNSS AssistNow Offline Assistance

Message		MGA-ANO					
Description		Multiple GNSS AssistNow Offline Assistance					
Firmware		Supported on: <ul style="list-style-type: none"> u-blox 8 / u-blox M8 from protocol version 15 up to version 23.01 					
Type		Input					
Comment		This message is created by the AssistNow Offline service to deliver AssistNow Offline assistance to the receiver. See the description of AssistNow Offline for details.					
Message Structure		Header	Class	ID	Length (Bytes)	Payload	Checksum
		0xB5 0x62	0x13	0x20	76	see below	CK_A CK_B
Payload Contents:							
Byte Offset	Number Format	Scaling	Name	Unit	Description		
0	U1	-	type	-	Message type (0x00 for this type)		
1	U1	-	version	-	Message version (0x00 for this version)		
2	U1	-	svId	-	Satellite identifier (see Satellite Numbering)		
3	U1	-	gnssId	-	GNSS identifier (see Satellite Numbering)		
4	U1	-	year	-	years since the year 2000		
5	U1	-	month	-	month (1..12)		
6	U1	-	day	-	day (1..31)		
7	U1	-	reserved1	-	Reserved		
8	U1[64]	-	data	-	assistance data		
72	U1[4]	-	reserved2	-	Reserved		

31.16.3 UBX-MGA-BDS (0x13 0x03)

31.16.3.1 UBX-MGA-BDS-EPH

Message		UBX-MGA-BDS-EPH					
Description		BDS Ephemeris Assistance					
Firmware		Supported on: <ul style="list-style-type: none"> u-blox 8 / u-blox M8 from protocol version 15 up to version 23.01 					
Type		Input					
Comment		This message allows the delivery of BeiDou ephemeris assistance to a receiver. See the description of AssistNow Online for details.					
Message Structure		Header	Class	ID	Length (Bytes)	Payload	Checksum
		0xB5 0x62	0x13	0x03	88	see below	CK_A CK_B
Payload Contents:							
Byte Offset	Number Format	Scaling	Name	Unit	Description		
0	U1	-	type	-	Message type (0x01 for this type)		
1	U1	-	version	-	Message version (0x00 for this version)		
2	U1	-	svId	-	BDS satellite identifier (see Satellite Numbering)		
3	U1	-	reserved1	-	Reserved		
4	U1	-	SatH1	-	Autonomous satellite Health flag		
5	U1	-	IODC	-	Issue of Data, Clock		

MGA-BDS continued

Byte Offset	Number Format	Scaling	Name	Unit	Description
6	I2	2^{-66}	a2	s/s ²	Time polynomial coefficient 2
8	I4	2^{-50}	a1	s/s	Time polynomial coefficient 1
12	I4	2^{-33}	a0	s	Time polynomial coefficient 0
16	U4	2^3	toc	s	Clock data reference time
20	I2	0.1	TGD1	ns	Equipment Group Delay Differential
22	U1	-	URAI	-	User Range Accuracy Index
23	U1	-	IODE	-	Issue of Data, Ephemeris
24	U4	2^3	toe	s	Ephemeris reference time
28	U4	2^{-19}	sqrtA	m ^{0.5}	Square root of semi-major axis
32	U4	2^{-33}	e	-	Eccentricity
36	I4	2^{-31}	omega	semi-circles	Argument of perigee
40	I2	2^{-43}	Del tan	semi-circles/s	Mean motion difference from computed value
42	I2	2^{-43}	IDOT	semi-circles/s	Rate of inclination angle
44	I4	2^{-31}	M0	semi-circles	Mean anomaly at reference time
48	I4	2^{-31}	Omega0	semi-circles	Longitude of ascending node of orbital of plane computed according to reference time
52	I4	2^{-43}	OmegaDot	semi-circles/s	Rate of right ascension
56	I4	2^{-31}	i0	semi-circles	Inclination angle at reference time
60	I4	2^{-31}	Cuc	semi-circles	Amplitude of cosine harmonic correction term to the argument of latitude
64	I4	2^{-31}	Cus	semi-circles	Amplitude of sine harmonic correction term to the argument of latitude
68	I4	2^{-6}	Crc	m	Amplitude of cosine harmonic correction term to the orbit radius
72	I4	2^{-6}	Crs	m	Amplitude of sine harmonic correction term to the orbit radius
76	I4	2^{-31}	Cic	semi-circles	Amplitude of cosine harmonic correction term to the angle of inclination
80	I4	2^{-31}	Cis	semi-circles	Amplitude of sine harmonic correction term to the angle of inclination
84	U1[4]	-	reserved2	-	Reserved

31.16.3.2 UBX-MGA-BDS-ALM

Message		UBX-MGA-BDS-ALM					
Description		BDS Almanac Assistance					
Firmware		Supported on: <ul style="list-style-type: none"> • u-blox 8 / u-blox M8 from protocol version 15 up to version 23.01 					
Type		Input					
Comment		This message allows the delivery of BeiDou almanac assistance to a receiver. See the description of AssistNow Online for details.					
Message Structure		Header	Class	ID	Length (Bytes)	Payload	Checksum
		0xB5 0x62	0x13	0x03	40	see below	CK_A CK_B
Payload Contents:							
Byte Offset	Number Format	Scaling	Name	Unit	Description		
0	U1	-	type	-	Message type (0x02 for this version)		
1	U1	-	version	-	Message version (0x00 for this version)		
2	U1	-	svId	-	BeiDou satellite identifier (see Satellite Numbering)		
3	U1	-	reserved1	-	Reserved		
4	U1	-	wna	week	Almanac Week Number		
5	U1	2 ¹²	toa	s	Almanac reference time		
6	I2	2 ⁻¹⁹	deltaI	semi-circles	Almanac correction of orbit reference inclination at reference time		
8	U4	2 ⁻¹¹	sqrtA	m ^{0.5}	Almanac square root of semi-major axis		
12	U4	2 ⁻²¹	e	-	Almanac eccentricity		
16	I4	2 ⁻²³	omega	semi-circles	Almanac argument of perigee		
20	I4	2 ⁻²³	M0	semi-circles	Almanac mean anomaly at reference time		
24	I4	2 ⁻²³	Omega0	semi-circles	Almanac longitude of ascending node of orbit plane at computed according to reference time		
28	I4	2 ⁻³⁸	omegaDot	semi-circles/s	Almanac rate of right ascension		
32	I2	2 ⁻²⁰	a0	s	Almanac satellite clock bias		
34	I2	2 ⁻³⁸	a1	s/s	Almanac satellite clock rate		
36	U1[4]	-	reserved2	-	Reserved		

31.16.3.3 UBX-MGA-BDS-HEALTH

Message		UBX-MGA-BDS-HEALTH					
Description		BDS Health Assistance					
Firmware		Supported on: <ul style="list-style-type: none"> • u-blox 8 / u-blox M8 from protocol version 15 up to version 23.01 					
Type		Input					
Comment		This message allows the delivery of BeiDou health assistance to a receiver. See the description of AssistNow Online for details.					
Message Structure		Header	Class	ID	Length (Bytes)	Payload	Checksum
		0xB5 0x62	0x13	0x03	68	see below	CK_A CK_B
Payload Contents:							
Byte Offset	Number Format	Scaling	Name	Unit	Description		
0	U1	-	type	-	Message type (0x04 for this type)		
1	U1	-	version	-	Message version (0x00 for this version)		
2	U1[2]	-	reserved1	-	Reserved		
4	U2[30]	-	healthCode	-	Each two-byte value represents a BDS SV (1-30). The 9 LSBs of each byte contain the 9 bit health code from subframe 5 pages 7,8 of the D1 message, and from subframe 5 pages 35,36 of the D1 message.		
64	U1[4]	-	reserved2	-	Reserved		

31.16.3.4 UBX-MGA-BDS-UTC

Message		UBX-MGA-BDS-UTC					
Description		BDS UTC Assistance					
Firmware		Supported on: <ul style="list-style-type: none"> • u-blox 8 / u-blox M8 from protocol version 15 up to version 23.01 					
Type		Input					
Comment		This message allows the delivery of BeiDou UTC assistance to a receiver. See the description of AssistNow Online for details.					
Message Structure		Header	Class	ID	Length (Bytes)	Payload	Checksum
		0xB5 0x62	0x13	0x03	20	see below	CK_A CK_B
Payload Contents:							
Byte Offset	Number Format	Scaling	Name	Unit	Description		
0	U1	-	type	-	Message type (0x05 for this type)		
1	U1	-	version	-	Message version (0x00 for this version)		
2	U1[2]	-	reserved1	-	Reserved		
4	I4	2 ⁻³⁰	a0UTC	s	BDT clock bias relative to UTC		
8	I4	2 ⁻⁵⁰	a1UTC	s/s	BDT clock rate relative to UTC		
12	I1	-	dtLS	s	Delta time due to leap seconds before the new leap second effective		
13	U1[1]	-	reserved2	-	Reserved		

MGA-BDS continued

Byte Offset	Number Format	Scaling	Name	Unit	Description
14	U1	-	wnRec	week	BeiDou week number of reception of this UTC parameter set (8 bit truncated)
15	U1	-	wnLSF	week	Week number of the new leap second
16	U1	-	dN	day	Day number of the new leap second
17	I1	-	dtLSF	s	Delta time due to leap seconds after the new leap second effective
18	U1[2]	-	reserved3	-	Reserved

31.16.3.5 UBX-MGA-BDS-IONO

Message	UBX-MGA-BDS-IONO					
Description	BDS Ionospheric Assistance					
Firmware	Supported on: <ul style="list-style-type: none"> • u-blox 8 / u-blox M8 from protocol version 15 up to version 23.01 					
Type	Input					
Comment	This message allows the delivery of BeiDou ionospheric assistance to a receiver. See the description of AssistNow Online for details.					
Message Structure	Header	Class	ID	Length (Bytes)	Payload	Checksum
	0xB5 0x62	0x13	0x03	16	<i>see below</i>	CK_A CK_B
Payload Contents:						
Byte Offset	Number Format	Scaling	Name	Unit	Description	
0	U1	-	type	-	Message type (0x06 for this type)	
1	U1	-	version	-	Message version (0x00 for this version)	
2	U1[2]	-	reserved1	-	Reserved	
4	I1	2 ⁻³⁰	alpha0	s	Ionospheric parameter alpha0	
5	I1	2 ⁻²⁷	alpha1	s/pi	Ionospheric parameter alpha1	
6	I1	2 ⁻²⁴	alpha2	s/pi ²	Ionospheric parameter alpha2	
7	I1	2 ⁻²⁴	alpha3	s/pi ³	Ionospheric parameter alpha3	
8	I1	2 ⁻¹¹	beta0	s	Ionospheric parameter beta0	
9	I1	2 ⁻¹⁴	beta1	s/pi	Ionospheric parameter beta1	
10	I1	2 ⁻¹⁶	beta2	s/pi ²	Ionospheric parameter beta2	
11	I1	2 ⁻¹⁶	beta3	s/pi ³	Ionospheric parameter beta3	
12	U1[4]	-	reserved2	-	Reserved	

31.16.4 UBX-MGA-DBD (0x13 0x80)

31.16.4.1 Poll the Navigation Database

Message	MGA-DBD					
Description	Poll the Navigation Database					
Firmware	Supported on: <ul style="list-style-type: none"> u-blox 8 / u-blox M8 from protocol version 15 up to version 23.01 					
Type	Poll Request					
Comment	Poll the whole navigation data base. The receiver will send all available data from its internal database. The receiver will indicate the finish of the transmission with a UBX-MGA-ACK . The msgPayloadStart field of the UBX-MGA-ACK message will contain a U4 representing the number of UBX-MGA-DBD-DATA* messages sent.					
Message Structure	Header	Class	ID	Length (Bytes)	Payload	Checksum
	0xB5 0x62	0x13	0x80	0	see below	CK_A CK_B
No payload						

31.16.4.2 Navigation Database Dump Entry

Message	MGA-DBD					
Description	Navigation Database Dump Entry					
Firmware	Supported on: <ul style="list-style-type: none"> u-blox 8 / u-blox M8 from protocol version 15 up to version 23.01 					
Type	Input/Output					
Comment	<p>UBX-MGA-DBD messages are only intended to be sent back to the same receiver that generated them.</p> <p>Navigation database entry. The data fields are firmware specific. Transmission of this type of message will be acknowledged by MGA-ACK messages, if acknowledgment has been enabled (see the description of flow control for details).</p> <p>The maximum payload size for firmware 2.01 onwards is 164 bytes (which makes the maximum message size 172 bytes).</p>					
Message Structure	Header	Class	ID	Length (Bytes)	Payload	Checksum
	0xB5 0x62	0x13	0x80	12 + 1*N	see below	CK_A CK_B
Payload Contents:						
Byte Offset	Number Format	Scaling	Name	Unit	Description	
0	U1[12]	-	reserved1	-	Reserved	
Start of repeated block (N times)						
12 + 1*N	U1	-	data	-	fw specific data	
End of repeated block						

31.16.5 UBX-MGA-FLASH (0x13 0x21)

31.16.5.1 UBX-MGA-FLASH-DATA

<i>Message</i>	UBX-MGA-FLASH-DATA					
<i>Description</i>	Transfer MGA-ANO data block to flash					
<i>Firmware</i>	Supported on: <ul style="list-style-type: none"> u-blox 8 / u-blox M8 from protocol version 15 up to version 23.01 					
<i>Type</i>	Input					
<i>Comment</i>	This message is used to transfer a block of MGA-ANO data from host to the receiver. Upon reception of this message, the receiver will write the payload data to its internal non-volatile memory (flash). Also, on reception of the first MGA-FLASH-DATA message, the receiver will erase the flash allocated to storing any existing MGA-ANO data. The payload can be up to 512 bytes. Payloads larger than this would exceed the receiver's internal buffering capabilities. The receiver will ACK/NACK this message using the message alternatives given below. The host shall wait for an acknowledge message before sending the next data block. See Flash-based AssistNow Offline for details.					
<i>Message Structure</i>	<i>Header</i>	<i>Class</i>	<i>ID</i>	<i>Length (Bytes)</i>	<i>Payload</i>	<i>Checksum</i>
	0xB5 0x62	0x13	0x21	6 + 1*size	see below	CK_A CK_B
<i>Payload Contents:</i>						
<i>Byte Offset</i>	<i>Number Format</i>	<i>Scaling</i>	<i>Name</i>	<i>Unit</i>	<i>Description</i>	
0	U1	-	type	-	Message type (0x01 for this type)	
1	U1	-	version	-	Message version (0x00 for this version)	
2	U2	-	sequence	-	Message sequence number, starting at 0 and incrementing by 1 for each MGA-FLASH-DATA message sent.	
4	U2	-	size	-	Payload size in bytes.	
<i>Start of repeated block (size times)</i>						
6 + 1*N	U1	-	data	-	Payload data.	
<i>End of repeated block</i>						

31.16.5.2 UBX-MGA-FLASH-STOP

<i>Message</i>	UBX-MGA-FLASH-STOP					
<i>Description</i>	Finish flashing MGA-ANO data					
<i>Firmware</i>	Supported on: <ul style="list-style-type: none"> u-blox 8 / u-blox M8 from protocol version 15 up to version 23.01 					
<i>Type</i>	Input					
<i>Comment</i>	This message is used to tell the receiver that there are no more MGA-FLASH type 1 messages coming, and that it can do any final internal operations needed to commit the data to flash as a background activity. A UBX-MGA-ACK message will be sent at the end of this process. Note that there may be a delay of several seconds before the UBX-MGA-ACK for this message is sent because of the time taken for this processing. See Flash-based AssistNow Offline for details.					
<i>Message Structure</i>	<i>Header</i>	<i>Class</i>	<i>ID</i>	<i>Length (Bytes)</i>	<i>Payload</i>	<i>Checksum</i>
	0xB5 0x62	0x13	0x21	2	see below	CK_A CK_B
<i>Payload Contents:</i>						

MGA-FLASH continued

Byte Offset	Number Format	Scaling	Name	Unit	Description
0	U1	-	type	-	Message type (0x02 for this type)
1	U1	-	version	-	Message version (0x00 for this version)

31.16.5.3 UBX-MGA-FLASH-ACK

Message	UBX-MGA-FLASH-ACK					
Description	Acknowledge last FLASH-DATA or -STOP					
Firmware	Supported on: <ul style="list-style-type: none"> u-blox 8 / u-blox M8 from protocol version 15 up to version 23.01 					
Type	Output					
Comment	This message reports an ACK/NACK to the host for the last MGA-FLASH type 1 or type 2 message message received. See Flash-based AssistNow Offline for details.					
Message Structure	Header	Class	ID	Length (Bytes)	Payload	Checksum
	0xB5 0x62	0x13	0x21	6	see below	CK_A CK_B
Payload Contents:						
Byte Offset	Number Format	Scaling	Name	Unit	Description	
0	U1	-	type	-	Message type (0x03 for this type)	
1	U1	-	version	-	Message version (0x00 for this version)	
2	U1	-	ack	-	Acknowledgment type. 0 - ACK: Message received and written to flash. 1 - NACK: Problem with last message, re-transmission required (this only happens while acknowledging a UBX-MGA_FLASH_DATA message). 2 - NACK: problem with last message, give up.	
3	U1	-	reserved1	-	Reserved	
4	U2	-	sequence	-	If acknowledging a UBX-MGA-FLASH-DATA message this is the Message sequence number being ack'ed. If acknowledging a UBX-MGA-FLASH-STOP message it will be set to 0xffff.	

31.16.6 UBX-MGA-GAL (0x13 0x02)

31.16.6.1 UBX-MGA-GAL-EPH

Message	UBX-MGA-GAL-EPH					
Description	Galileo Ephemeris Assistance					
Firmware	Supported on: <ul style="list-style-type: none"> u-blox 8 / u-blox M8 from protocol version 18 up to version 23.01 					
Type	Input					
Comment	This message allows the delivery of Galileo ephemeris assistance to a receiver. See the description of AssistNow Online for details.					
Message Structure	Header	Class	ID	Length (Bytes)	Payload	Checksum
	0xB5 0x62	0x13	0x02	76	see below	CK_A CK_B
Payload Contents:						
Byte Offset	Number Format	Scaling	Name	Unit	Description	
0	U1	-	type	-	Message type (0x01 for this type)	
1	U1	-	version	-	Message version (0x00 for this version)	
2	U1	-	svId	-	Galileo Satellite identifier (see Satellite Numbering)	
3	U1	-	reserved1	-	Reserved	
4	U2	-	iodNav	-	Ephemeris and clock correction Issue of Data	
6	I2	2 ⁻⁴³	deltaN	semi-circles/s	Mean motion difference from computed value	
8	I4	2 ⁻³¹	m0	semi-circles	Mean anomaly at reference time	
12	U4	2 ⁻³³	e	-	Eccentricity	
16	U4	2 ⁻¹⁹	sqrtA	m ^{0.5}	Square root of the semi-major axis	
20	I4	2 ⁻³¹	omega0	semi-circles	Longitude of ascending node of orbital plane at weekly epoch	
24	I4	2 ⁻³¹	i0	semi-circles	Inclination angle at reference time	
28	I4	2 ⁻³¹	omega	semi-circles	Argument of perigee	
32	I4	2 ⁻⁴³	omegaDot	semi-circles/s	Rate of change of right ascension	
36	I2	2 ⁻⁴³	iDot	semi-circles/s	Rate of change of inclination angle	
38	I2	2 ⁻²⁹	cuc	radians	Amplitude of the cosine harmonic correction term to the argument of latitude	
40	I2	2 ⁻²⁹	cus	radians	Amplitude of the sine harmonic correction term to the argument of latitude	
42	I2	2 ⁻⁵	crs	radians	Amplitude of the cosine harmonic correction term to the orbit radius	
44	I2	2 ⁻⁵	crs	radians	Amplitude of the sine harmonic correction term to the orbit radius	
46	I2	2 ⁻²⁹	cic	radians	Amplitude of the cosine harmonic correction term to the angle of inclination	

MGA-GAL continued

Byte Offset	Number Format	Scaling	Name	Unit	Description
48	I2	2 ⁻²⁹	cis	radians	Amplitude of the sine harmonic correction term to the angle of inclination
50	U2	60	toe	s	Ephemeris reference time
52	I4	2 ⁻³⁴	af0	s	SV clock bias correction coefficient
56	I4	2 ⁻⁴⁶	af1	s/s	SV clock drift correction coefficient
60	I1	2 ⁻⁵⁹	af2	s/s squared	SV clock drift rate correction coefficient
61	U1	-	sisaIndexE1E5b	-	Signal-In-Space Accuracy index for dual frequency E1-E5b
62	U2	60	toc	s	Clock correction data reference Time of Week
64	I2	-	bgdE1E5b	-	E1-E5b Broadcast Group Delay
66	U1[2]	-	reserved2	-	Reserved
68	U1	-	healthE1B	-	E1-B Signal Health Status
69	U1	-	dataValidityE1B	-	E1-B Data Validity Status
70	U1	-	healthE5b	-	E5b Signal Health Status
71	U1	-	dataValidityE5b	-	E5b Data Validity Status
72	U1[4]	-	reserved3	-	Reserved

31.16.6.2 UBX-MGA-GAL-ALM

Message	UBX-MGA-GAL-ALM					
Description	Galileo Almanac Assistance					
Firmware	Supported on: <ul style="list-style-type: none"> u-blox 8 / u-blox M8 from protocol version 18 up to version 23.01 					
Type	Input					
Comment	This message allows the delivery of Galileo almanac assistance to a receiver. See the description of AssistNow Online for details.					
Message Structure	Header	Class	ID	Length (Bytes)	Payload	Checksum
	0xB5 0x62	0x13	0x02	32	see below	CK_A CK_B
Payload Contents:						
Byte Offset	Number Format	Scaling	Name	Unit	Description	
0	U1	-	type	-	Message type (0x02 for this type)	
1	U1	-	version	-	Message version (0x00 for this version)	
2	U1	-	svId	-	Galileo Satellite identifier (see Satellite Numbering)	
3	U1	-	reserved1	-	Reserved	
4	U1	-	ioda	-	Almanac Issue of Data	
5	U1	-	almWNa	week	Almanac reference week number	
6	U2	600	toa	s	Almanac reference time	
8	I2	2 ⁻⁹	deltaSqrtA	m ^{0.5}	Difference with respect to the square root of the nominal semi-major axis (29 600 km)	

MGA-GAL continued

Byte Offset	Number Format	Scaling	Name	Unit	Description
10	U2	2 ⁻¹⁶	e	-	Eccentricity
12	I2	2 ⁻¹⁴	deltaI	semi-circles	Inclination at reference time relative to i0 = 56 degree
14	I2	2 ⁻¹⁵	omega0	semi-circles	Longitude of ascending node of orbital plane at weekly epoch
16	I2	2 ⁻³³	omegaDot	semi-circles/s	Rate of change of right ascension
18	I2	2 ⁻¹⁵	omega	semi-circles	Argument of perigee
20	I2	2 ⁻¹⁵	m0	semi-circles	Satellite mean anomaly at reference time
22	I2	2 ⁻¹⁹	af0	s	Satellite clock correction bias 'truncated'
24	I2	2 ⁻³⁸	af1	s/s	Satellite clock correction linear 'truncated'
26	U1	-	healthE1B	-	Satellite E1-B signal health status
27	U1	-	healthE5b	-	Satellite E5b signal health status
28	U1[4]	-	reserved2	-	Reserved

31.16.6.3 UBX-MGA-GAL-TIMEOFFSET

Message	UBX-MGA-GAL-TIMEOFFSET					
Description	Galileo GPS time offset assistance					
Firmware	Supported on: <ul style="list-style-type: none"> u-blox 8 / u-blox M8 from protocol version 18 up to version 23.01 					
Type	Input					
Comment	This message allows the delivery of Galileo time to GPS time offset. See the description of AssistNow Online for details.					
Message Structure	Header	Class	ID	Length (Bytes)	Payload	Checksum
	0xB5 0x62	0x13	0x02	12	see below	CK_A CK_B
Payload Contents:						
Byte Offset	Number Format	Scaling	Name	Unit	Description	
0	U1	-	type	-	Message type (0x03 for this type)	
1	U1	-	version	-	Message version (0x00 for this version)	
2	U1[2]	-	reserved1	-	Reserved	
4	I2	2 ⁻³⁵	a0G	s	Constant term of the polynomial describing the offset	
6	I2	2 ⁻⁵¹	a1G	s/s	Rate of change of the offset	
8	U1	3600	t0G	s	DReference time for GGTO data	
9	U1	-	wn0G	weeks	Week Number of GGTO reference	
10	U1[2]	-	reserved2	-	Reserved	

31.16.6.4 UBXMGA-GAL-UTC

Message		UBXMGA-GAL-UTC					
Description		Galileo UTC Assistance					
Firmware		Supported on: <ul style="list-style-type: none"> u-blox 8 / u-blox M8 from protocol version 18 up to version 23.01 					
Type		Input					
Comment		This message allows the delivery of Galileo UTC assistance to a receiver. See the description of AssistNow Online for details.					
Message Structure		Header	Class	ID	Length (Bytes)	Payload	Checksum
		0xB5 0x62	0x13	0x02	20	see below	CK_A CK_B
Payload Contents:							
Byte Offset	Number Format	Scaling	Name	Unit	Description		
0	U1	-	type	-	Message type (0x05 for this type)		
1	U1	-	version	-	Message version (0x00 for this version)		
2	U1[2]	-	reserved1	-	Reserved		
4	I4	2 ⁻³⁰	a0	s	First parameter of UTC polynomial		
8	I4	2 ⁻⁵⁰	a1	s/s	Second parameter of UTC polynomial		
12	I1	-	dtLS	s	Delta time due to current leap seconds		
13	U1	3600	tot	s	UTC parameters reference time of week (Galileo time)		
14	U1	-	wnt	weeks	UTC parameters reference week number (the 8 bit Wnt field)		
15	U1	-	wnLSF	weeks	Week number at the end of which the future leap second becomes effective (the 8 bit WNLSF field)		
16	U1	-	dN	days	Day number at the end of which the future leap second becomes effective		
17	I1	-	dTLSF	s	Delta time due to future leap seconds		
18	U1[2]	-	reserved2	-	Reserved		

31.16.7 UBXMGA-GLO (0x13 0x06)

31.16.7.1 UBXMGA-GLO-EPH

Message		UBXMGA-GLO-EPH					
Description		GLONASS Ephemeris Assistance					
Firmware		Supported on: <ul style="list-style-type: none"> u-blox 8 / u-blox M8 from protocol version 15 up to version 23.01 					
Type		Input					
Comment		This message allows the delivery of GLONASS ephemeris assistance to a receiver. See the description of AssistNow Online for details.					
Message Structure		Header	Class	ID	Length (Bytes)	Payload	Checksum
		0xB5 0x62	0x13	0x06	48	see below	CK_A CK_B
Payload Contents:							
Byte Offset	Number Format	Scaling	Name	Unit	Description		

MGA-GLO continued

Byte Offset	Number Format	Scaling	Name	Unit	Description
0	U1	-	type	-	Message type (0x01 for this type)
1	U1	-	version	-	Message version (0x00 for this version)
2	U1	-	svId	-	GLONASS Satellite identifier (see Satellite Numbering)
3	U1	-	reserved1	-	Reserved
4	U1	-	FT	-	User range accuracy
5	U1	-	B	-	Health flag from string 2
6	U1	-	M	-	Type of GLONASS satellite (1 indicates GLONASS-M)
7	I1	-	H	-	Carrier frequency number of navigation RF signal, Range=(-7 .. 6), -128 for unknown
8	I4	2 ⁻¹¹	x	km	X component of the SV position in PZ-90.02 coordinate System
12	I4	2 ⁻¹¹	y	km	Y component of the SV position in PZ-90.02 coordinate System
16	I4	2 ⁻¹¹	z	km	Z component of the SV position in PZ-90.02 coordinate System
20	I4	2 ⁻²⁰	dx	km/s	X component of the SV velocity in PZ-90.02 coordinate System
24	I4	2 ⁻²⁰	dy	km/s	Y component of the SV velocity in PZ-90.02 coordinate System
28	I4	2 ⁻²⁰	dz	km/s	Z component of the SV velocity in PZ-90.02 coordinate System
32	I1	2 ⁻³⁰	ddx	km/s ²	X component of the SV acceleration in PZ-90.02 coordinate System
33	I1	2 ⁻³⁰	ddy	km/s ²	Y component of the SV acceleration in PZ-90.02 coordinate System
34	I1	2 ⁻³⁰	ddz	km/s ²	Z component of the SV acceleration in PZ-90.02 coordinate System
35	U1	15	tb	minutes	Index of a time interval within current day according to UTC(SU)
36	I2	2 ⁻⁴⁰	gamma	-	Relative carrier frequency deviation
38	U1	-	E	days	Ephemeris data age indicator
39	I1	2 ⁻³⁰	deltaTau	s	Time difference between L2 and L1 band
40	I4	2 ⁻³⁰	tau	s	SV clock bias
44	U1[4]	-	reserved2	-	Reserved

31.16.7.2 UBX-MGA-GLO-ALM

Message		UBX-MGA-GLO-ALM					
Description		GLONASS Almanac Assistance					
Firmware		Supported on: <ul style="list-style-type: none"> u-blox 8 / u-blox M8 from protocol version 15 up to version 23.01 					
Type		Input					
Comment		This message allows the delivery of GLONASS almanac assistance to a receiver. See the description of AssistNow Online for details.					
Message Structure		Header	Class	ID	Length (Bytes)	Payload	Checksum
		0xB5 0x62	0x13	0x06	36	see below	CK_A CK_B
Payload Contents:							
Byte Offset	Number Format	Scaling	Name	Unit	Description		
0	U1	-	type	-	Message type (0x02 for this type)		
1	U1	-	version	-	Message version (0x00 for this version)		
2	U1	-	svId	-	GLONASS Satellite identifier (see Satellite Numbering)		
3	U1	-	reserved1	-	Reserved		
4	U2	-	N	days	Reference calendar day number of almanac within the four-year period (from string 5)		
6	U1	-	M	-	Type of GLONASS satellite (1 indicates GLONASS-M)		
7	U1	-	C	-	Unhealthy flag at instant of almanac upload (1 indicates operability of satellite)		
8	I2	2 ⁻¹⁸	tau	s	Coarse time correction to GLONASS time		
10	U2	2 ⁻²⁰	epsilon	-	Eccentricity		
12	I4	2 ⁻²⁰	lambda	semi-circles	Longitude of the first (within the N-day) ascending node of satellite orbit in PC-90.02 coordinate system		
16	I4	2 ⁻²⁰	deltaI	semi-circles	Correction to the mean value of inclination		
20	U4	2 ⁻⁵	tLambda	s	Time of the first ascending node passage		
24	I4	2 ⁻⁹	deltaT	s/orbital-period	Correction to the mean value of Draconian period		
28	I1	2 ⁻¹⁴	deltaDT	s/orbital-period ²	Rate of change of Draconian period		
29	I1	-	H	-	Carrier frequency number of navigation RF signal, Range=(-7 .. 6)		
30	I2	-	omega	-	Argument of perigee		
32	U1[4]	-	reserved2	-	Reserved		

31.16.7.3 UBX-MGA-GLO-TIMEOFFSET

Message		UBX-MGA-GLO-TIMEOFFSET					
Description		GLONASS Auxiliary Time Offset Assistance					
Firmware		Supported on: <ul style="list-style-type: none"> • u-blox 8 / u-blox M8 from protocol version 15 up to version 23.01 					
Type		Input					
Comment		This message allows the delivery of auxiliary GLONASS assistance (including the GLONASS time offsets to other GNSS systems) to a receiver. See the description of AssistNow Online for details.					
Message Structure		Header	Class	ID	Length (Bytes)	Payload	Checksum
		0xB5 0x62	0x13	0x06	20	see below	CK_A CK_B
Payload Contents:							
Byte Offset	Number Format	Scaling	Name	Unit	Description		
0	U1	-	type	-	Message type (0x03 for this type)		
1	U1	-	version	-	Message version (0x00 for this version)		
2	U2	-	N	days	Reference calendar day number within the four-year period of almanac (from string 5)		
4	I4	2 ⁻²⁷	tauC	s	Time scale correction to UTC(SU) time		
8	I4	2 ⁻³¹	tauGps	s	Correction to GPS time relative to GLONASS time		
12	I2	2 ⁻¹⁰	B1	s	Coefficient to determine delta UT1		
14	I2	2 ⁻¹⁶	B2	s/msd	Rate of change of delta UT1		
16	U1[4]	-	reserved1	-	Reserved		

31.16.8 UBX-MGA-GPS (0x13 0x00)

31.16.8.1 UBX-MGA-GPS-EPH

Message		UBX-MGA-GPS-EPH					
Description		GPS Ephemeris Assistance					
Firmware		Supported on: <ul style="list-style-type: none"> • u-blox 8 / u-blox M8 from protocol version 15 up to version 23.01 					
Type		Input					
Comment		This message allows the delivery of GPS ephemeris assistance to a receiver. See the description of AssistNow Online for details.					
Message Structure		Header	Class	ID	Length (Bytes)	Payload	Checksum
		0xB5 0x62	0x13	0x00	68	see below	CK_A CK_B
Payload Contents:							
Byte Offset	Number Format	Scaling	Name	Unit	Description		
0	U1	-	type	-	Message type (0x01 for this type)		
1	U1	-	version	-	Message version (0x00 for this version)		
2	U1	-	svId	-	GPS Satellite identifier (see Satellite Numbering)		
3	U1	-	reserved1	-	Reserved		
4	U1	-	fitInterval	-	Fit interval flag		
5	U1	-	uraIndex	-	URA index		

MGA-GPS continued

Byte Offset	Number Format	Scaling	Name	Unit	Description
6	U1	-	svHealth	-	SV health
7	I1	2^{-31}	tgD	s	Group delay differential
8	U2	-	iodc	-	IODC
10	U2	2^4	toc	s	Clock data reference time
12	U1	-	reserved2	-	Reserved
13	I1	2^{-55}	af2	s/s squared	Time polynomial coefficient 2
14	I2	2^{-43}	af1	s/s	Time polynomial coefficient 1
16	I4	2^{-31}	af0	s	Time polynomial coefficient 0
20	I2	2^{-5}	crs	m	Crs
22	I2	2^{-43}	deltaN	semi-circles/s	Mean motion difference from computed value
24	I4	2^{-31}	m0	semi-circles	Mean anomaly at reference time
28	I2	2^{-29}	cuc	radians	Amplitude of cosine harmonic correction term to argument of latitude
30	I2	2^{-29}	cus	radians	Amplitude of sine harmonic correction term to argument of latitude
32	U4	2^{-33}	e	-	Eccentricity
36	U4	2^{-19}	sqrtA	$m^{0.5}$	Square root of the semi-major axis
40	U2	2^4	toe	s	Reference time of ephemeris
42	I2	2^{-29}	cic	radians	Amplitude of cos harmonic correction term to angle of inclination
44	I4	2^{-31}	omega0	semi-circles	Longitude of ascending node of orbit plane at weekly epoch
48	I2	2^{-29}	cis	radians	Amplitude of sine harmonic correction term to angle of inclination
50	I2	2^{-5}	crc	m	Amplitude of cosine harmonic correction term to orbit radius
52	I4	2^{-31}	i0	semi-circles	Inclination angle at reference time
56	I4	2^{-31}	omega	semi-circles	Argument of perigee
60	I4	2^{-43}	omegaDot	semi-circles/s	Rate of right ascension
64	I2	2^{-43}	idot	semi-circles/s	Rate of inclination angle
66	U1[2]	-	reserved3	-	Reserved

31.16.8.2 UBX-MGA-GPS-ALM

Message	UBX-MGA-GPS-ALM					
Description	GPS Almanac Assistance					
Firmware	Supported on: <ul style="list-style-type: none"> • u-blox 8 / u-blox M8 from protocol version 15 up to version 23.01 					
Type	Input					
Comment	This message allows the delivery of GPS almanac assistance to a receiver. See the description of AssistNow Online for details.					
Message Structure	Header	Class	ID	Length (Bytes)	Payload	Checksum
	0xB5 0x62	0x13	0x00	36	see below	CK_A CK_B
Payload Contents:						
Byte Offset	Number Format	Scaling	Name	Unit	Description	
0	U1	-	type	-	Message type (0x02 for this type)	
1	U1	-	version	-	Message version (0x00 for this version)	
2	U1	-	svId	-	GPS Satellite identifier (see Satellite Numbering)	
3	U1	-	svHealth	-	SV health information	
4	U2	2 ⁻²¹	e	-	Eccentricity	
6	U1	-	almWNa	week	Reference week number of almanac (the 8 bit WNa field)	
7	U1	2 ⁻¹²	toa	s	Reference time of almanac	
8	I2	2 ⁻¹⁹	deltaI	semi-circles	Delta inclination angle at reference time	
10	I2	2 ⁻³⁸	omegaDot	semi-circles/s	Rate of right ascension	
12	U4	2 ⁻¹¹	sqrtA	m ^{0.5}	Square root of the semi-major axis	
16	I4	2 ⁻²³	omega0	semi-circles	Longitude of ascending node of orbit plane	
20	I4	2 ⁻²³	omega	semi-circles	Argument of perigee	
24	I4	2 ⁻²³	m0	semi-circles	Mean anomaly at reference time	
28	I2	2 ⁻²⁰	af0	s	Time polynomial coefficient 0 (8 MSBs)	
30	I2	2 ⁻³⁸	af1	s/s	Time polynomial coefficient 1	
32	U1[4]	-	reserved1	-	Reserved	

31.16.8.3 UBX-MGA-GPS-HEALTH

Message		UBX-MGA-GPS-HEALTH					
Description		GPS Health Assistance					
Firmware		Supported on: <ul style="list-style-type: none"> • u-blox 8 / u-blox M8 from protocol version 15 up to version 23.01 					
Type		Input					
Comment		This message allows the delivery of GPS health assistance to a receiver. See the description of AssistNow Online for details.					
Message Structure		Header	Class	ID	Length (Bytes)	Payload	Checksum
		0xB5 0x62	0x13	0x00	40	see below	CK_A CK_B
Payload Contents:							
Byte Offset	Number Format	Scaling	Name	Unit	Description		
0	U1	-	type	-	Message type (0x04 for this type)		
1	U1	-	version	-	Message version (0x00 for this version)		
2	U1[2]	-	reserved1	-	Reserved		
4	U1[32]	-	healthCode	-	Each byte represents a GPS SV (1-32). The 6 LSBs of each byte contains the 6 bit health code from subframes 4/5 page 25.		
36	U1[4]	-	reserved2	-	Reserved		

31.16.8.4 UBX-MGA-GPS-UTC

Message		UBX-MGA-GPS-UTC					
Description		GPS UTC Assistance					
Firmware		Supported on: <ul style="list-style-type: none"> • u-blox 8 / u-blox M8 from protocol version 15 up to version 23.01 					
Type		Input					
Comment		This message allows the delivery of GPS UTC assistance to a receiver. See the description of AssistNow Online for details.					
Message Structure		Header	Class	ID	Length (Bytes)	Payload	Checksum
		0xB5 0x62	0x13	0x00	20	see below	CK_A CK_B
Payload Contents:							
Byte Offset	Number Format	Scaling	Name	Unit	Description		
0	U1	-	type	-	Message type (0x05 for this type)		
1	U1	-	version	-	Message version (0x00 for this version)		
2	U1[2]	-	reserved1	-	Reserved		
4	I4	2 ⁻³⁰	utcA0	s	First parameter of UTC polynomial		
8	I4	2 ⁻⁵⁰	utcA1	s/s	Second parameter of UTC polynomial		
12	I1	-	utcDtLS	s	Delta time due to current leap seconds		
13	U1	2 ¹²	utcTot	s	UTC parameters reference time of week (GPS time)		
14	U1	-	utcWNt	weeks	UTC parameters reference week number (the 8 bit WNt field)		

MGA-GPS continued

Byte Offset	Number Format	Scaling	Name	Unit	Description
15	U1	-	utcWNlSF	weeks	Week number at the end of which the future leap second becomes effective (the 8 bit WNLSF field)
16	U1	-	utcDn	days	Day number at the end of which the future leap second becomes effective
17	I1	-	utcDtLSF	s	Delta time due to future leap seconds
18	U1[2]	-	reserved2	-	Reserved

31.16.8.5 UBX-MGA-GPS-IONO

Message	UBX-MGA-GPS-IONO					
Description	GPS Ionosphere Assistance					
Firmware	Supported on: <ul style="list-style-type: none"> u-blox 8 / u-blox M8 from protocol version 15 up to version 23.01 					
Type	Input					
Comment	This message allows the delivery of GPS ionospheric assistance to a receiver. See the description of AssistNow Online for details.					
Message Structure	Header	Class	ID	Length (Bytes)	Payload	Checksum
	0xB5 0x62	0x13	0x00	16	see below	CK_A CK_B
Payload Contents:						
Byte Offset	Number Format	Scaling	Name	Unit	Description	
0	U1	-	type	-	Message type (0x06 for this type)	
1	U1	-	version	-	Message version (0x00 for this version)	
2	U1[2]	-	reserved1	-	Reserved	
4	I1	2 ⁻³⁰	ionoAlpha0	s	Ionospheric parameter alpha0 [s]	
5	I1	2 ⁻²⁷	ionoAlpha1	s/semi-circle	Ionospheric parameter alpha1 [s/semi-circle]	
6	I1	2 ⁻²⁴	ionoAlpha2	s/(semi-circle ²)	Ionospheric parameter alpha2 [s/semi-circle ²]	
7	I1	2 ⁻²⁴	ionoAlpha3	s/(semi-circle ³)	Ionospheric parameter alpha3 [s/semi-circle ³]	
8	I1	2 ⁻¹¹	ionoBeta0	s	Ionospheric parameter beta0 [s]	
9	I1	2 ⁻¹⁴	ionoBeta1	s/semi-circle	Ionospheric parameter beta1 [s/semi-circle]	
10	I1	2 ⁻¹⁶	ionoBeta2	s/(semi-circle ²)	Ionospheric parameter beta2 [s/semi-circle ²]	
11	I1	2 ⁻¹⁶	ionoBeta3	s/(semi-circle ³)	Ionospheric parameter beta3 [s/semi-circle ³]	
12	U1[4]	-	reserved2	-	Reserved	

31.16.9 UBX-MGA-INI (0x13 0x40)

31.16.9.1 UBX-MGA-INI-POS_XYZ

Message	UBX-MGA-INI-POS_XYZ					
Description	Initial Position Assistance					
Firmware	Supported on: <ul style="list-style-type: none"> u-blox 8 / u-blox M8 from protocol version 15 up to version 23.01 					
Type	Input					
Comment	<p>Supplying position assistance that is inaccurate by more than the specified position accuracy, may lead to substantially degraded receiver performance.</p> <p>This message allows the delivery of initial position assistance to a receiver in cartesian ECEF coordinates. This message is equivalent to the UBX-MGA-INI-POS_LLH message, except for the coordinate system. See the description of AssistNow Online for details.</p>					
Message Structure	Header	Class	ID	Length (Bytes)	Payload	Checksum
	0xB5 0x62	0x13	0x40	20	see below	CK_A CK_B
Payload Contents:						
Byte Offset	Number Format	Scaling	Name	Unit	Description	
0	U1	-	type	-	Message type (0x00 for this type)	
1	U1	-	version	-	Message version (0x00 for this version)	
2	U1[2]	-	reserved1	-	Reserved	
4	I4	-	ecefX	cm	WGS84 ECEF X coordinate	
8	I4	-	ecefY	cm	WGS84 ECEF Y coordinate	
12	I4	-	ecefZ	cm	WGS84 ECEF Z coordinate	
16	U4	-	posAcc	cm	Position accuracy (stddev)	

31.16.9.2 UBX-MGA-INI-POS_LLH

Message	UBX-MGA-INI-POS_LLH					
Description	Initial Position Assistance					
Firmware	Supported on: <ul style="list-style-type: none"> u-blox 8 / u-blox M8 from protocol version 15 up to version 23.01 					
Type	Input					
Comment	<p>Supplying position assistance that is inaccurate by more than the specified position accuracy, may lead to substantially degraded receiver performance.</p> <p>This message allows the delivery of initial position assistance to a receiver in WGS84 lat/long/alt coordinates. This message is equivalent to the UBX-MGA-INI-POS_XYZ message, except for the coordinate system. See the description of AssistNow Online for details.</p>					
Message Structure	Header	Class	ID	Length (Bytes)	Payload	Checksum
	0xB5 0x62	0x13	0x40	20	see below	CK_A CK_B
Payload Contents:						
Byte Offset	Number Format	Scaling	Name	Unit	Description	
0	U1	-	type	-	Message type (0x01 for this type)	
1	U1	-	version	-	Message version (0x00 for this version)	
2	U1[2]	-	reserved1	-	Reserved	

MGA-INI continued

Byte Offset	Number Format	Scaling	Name	Unit	Description
4	I4	1e-7	lat	deg	WGS84 Latitude
8	I4	1e-7	lon	deg	WGS84 Longitude
12	I4	-	alt	cm	WGS84 Altitude
16	U4	-	posAcc	cm	Position accuracy (stddev)

31.16.9.3 UBX-MGA-INI-TIME.UTC

Message	UBX-MGA-INI-TIME.UTC					
Description	Initial Time Assistance					
Firmware	Supported on: <ul style="list-style-type: none"> u-blox 8 / u-blox M8 from protocol version 15 up to version 23.01 					
Type	Input					
Comment	<p>Supplying time assistance that is inaccurate by more than the specified time accuracy, may lead to substantially degraded receiver performance.</p> <p>This message allows the delivery of UTC time assistance to a receiver. This message is equivalent to the UBX-MGA-INI-TIME_GNSS message, except for the time base. See the description of AssistNow Online for details.</p>					
Message Structure	Header	Class	ID	Length (Bytes)	Payload	Checksum
	0xB5 0x62	0x13	0x40	24	see below	CK_A CK_B
Payload Contents:						
Byte Offset	Number Format	Scaling	Name	Unit	Description	
0	U1	-	type	-	Message type (0x10 for this type)	
1	U1	-	version	-	Message version (0x00 for this version)	
2	X1	-	ref	-	Reference to be used to set time (see graphic below)	
3	I1	-	leapSecs	s	Number of leap seconds since 1980 (or 0x80 = -128 if unknown)	
4	U2	-	year	-	Year	
6	U1	-	month	-	Month, starting at 1	
7	U1	-	day	-	Day, starting at 1	
8	U1	-	hour	-	Hour, from 0 to 23	
9	U1	-	minute	-	Minute, from 0 to 59	
10	U1	-	second	s	Seconds, from 0 to 59	
11	U1	-	reserved1	-	Reserved	
12	U4	-	ns	ns	Nanoseconds, from 0 to 999,999,999	
16	U2	-	tAccS	s	Seconds part of time accuracy	
18	U1[2]	-	reserved2	-	Reserved	
20	U4	-	tAccNs	ns	Nanoseconds part of time accuracy, from 0 to 999,999,999	

Bitfield ref

This graphic explains the bits of `ref`

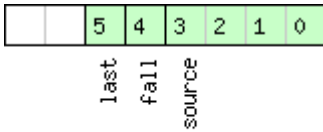

■ signed value
■ unsigned value
■ reserved

Name	Description
source	0: none, i.e. on receipt of message (will be inaccurate!) 1: relative to pulse sent to EXTINT0 2: relative to pulse sent to EXTINT1 3-15: reserved
fall	use falling edge of EXTINT pulse (default rising) - only if source is EXTINT
last	use last EXTINT pulse (default next pulse) - only if source is EXTINT

31.16.9.4 UBX-MGA-INI-TIME_GNSS

Message	UBX-MGA-INI-TIME_GNSS					
Description	Initial Time Assistance					
Firmware	Supported on: <ul style="list-style-type: none"> u-blox 8 / u-blox M8 from protocol version 15 up to version 23.01 					
Type	Input					
Comment	Supplying time assistance that is inaccurate by more than the specified time accuracy, may lead to substantially degraded receiver performance. This message allows the delivery of time assistance to a receiver in a chosen GNSS timebase. This message is equivalent to the UBX-MGA-INI-TIME_UTC message, except for the time base. See the description of AssistNow Online for details.					
Message Structure	Header	Class	ID	Length (Bytes)	Payload	Checksum
	0xB5 0x62	0x13	0x40	24	see below	CK_A CK_B
Payload Contents:						
Byte Offset	Number Format	Scaling	Name	Unit	Description	
0	U1	-	type	-	Message type (0x11 for this type)	
1	U1	-	version	-	Message version (0x00 for this version)	
2	X1	-	ref	-	Reference to be used to set time (see graphic below)	
3	U1	-	gnssId	-	Source of time information. Currently supported: 0: GPS time 2: Galileo time 3: BeiDou time 6: GLONASS time: week = 834 + ((N4-1)*1461 + Nt)/7, tow = (((N4-1)*1461 + Nt) % 7) * 86400 + tod	
4	U1[2]	-	reserved1	-	Reserved	
6	U2	-	week	-	GNSS week number	
8	U4	-	tow	-	GNSS time of week	

MGA-INI continued

Byte Offset	Number Format	Scaling	Name	Unit	Description
12	U4	-	ns	-	GNSS time of week, nanosecond part from 0 to 999,999,999
16	U2	-	tAccS	s	Seconds part of time accuracy
18	U1[2]	-	reserved2	-	Reserved
20	U4	-	tAccNs	ns	Nanoseconds part of time accuracy, from 0 to 999,999,999

Bitfield ref

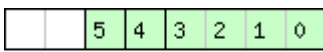
 This graphic explains the bits of `ref`

last
 fall
 source

signed value
 unsigned value
 reserved

Name	Description
source	0: none, i.e. on receipt of message (will be inaccurate!) 1: relative to pulse sent to EXTINT0 2: relative to pulse sent to EXTINT1 3-15: reserved
fall	use falling edge of EXTINT pulse (default rising) - only if source is EXTINT
last	use last EXTINT pulse (default next pulse) - only if source is EXTINT

31.16.9.5 UBX-MGA-INI-CLKD

Message	UBX-MGA-INI-CLKD					
Description	Initial Clock Drift Assistance					
Firmware	Supported on: <ul style="list-style-type: none"> u-blox 8 / u-blox M8 from protocol version 15 up to version 23.01 					
Type	Input					
Comment	Supplying clock drift assistance that is inaccurate by more than the specified accuracy, may lead to substantially degraded receiver performance. This message allows the delivery of clock drift assistance to a receiver. See the description of AssistNow Online for details.					
Message Structure	Header	Class	ID	Length (Bytes)	Payload	Checksum
	0xB5 0x62	0x13	0x40	12	see below	CK_A CK_B
Payload Contents:						
Byte Offset	Number Format	Scaling	Name	Unit	Description	
0	U1	-	type	-	Message type (0x20 for this type)	
1	U1	-	version	-	Message version (0x00 for this version)	
2	U1[2]	-	reserved1	-	Reserved	
4	I4	-	clkD	ns/s	Clock drift	
8	U4	-	clkDAcc	ns/s	Clock drift accuracy	

31.16.9.6 UBX-MGA-INI-FREQ

Message	UBX-MGA-INI-FREQ					
Description	Initial Frequency Assistance					
Firmware	Supported on: <ul style="list-style-type: none"> • u-blox 8 / u-blox M8 from protocol version 15 up to version 23.01 					
Type	Input					
Comment	Supplying external frequency assistance that is inaccurate by more than the specified accuracy, may lead to substantially degraded receiver performance. This message allows the delivery of external frequency assistance to a receiver. See the description of AssistNow Online for details.					
Message Structure	Header	Class	ID	Length (Bytes)	Payload	Checksum
	0xB5 0x62	0x13	0x40	12	see below	CK_A CK_B
Payload Contents:						
Byte Offset	Number Format	Scaling	Name	Unit	Description	
0	U1	-	type	-	Message type (0x21 for this type)	
1	U1	-	version	-	Message version (0x00 for this version)	
2	U1	-	reserved1	-	Reserved	
3	X1	-	flags	-	Frequency reference (see graphic below)	
4	I4	1e-2	freq	Hz	Frequency	
8	U4	-	freqAcc	ppb	Frequency accuracy	

Bitfield flags

This graphic explains the bits of flags

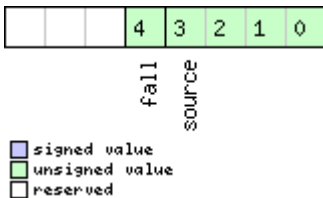

Name	Description
source	0: frequency available on EXTINT0 1: frequency available on EXTINT1 2-15: reserved
fall	use falling edge of EXTINT pulse (default rising)

31.16.9.7 UBX-MGA-INI-EOP

Message		UBX-MGA-INI-EOP					
Description		Earth Orientation Parameters Assistance					
Firmware		Supported on: <ul style="list-style-type: none"> u-blox 8 / u-blox M8 from protocol version 15 up to version 23.01 					
Type		Input					
Comment		This message allows the delivery of new Earth Orientation Parameters (EOP) to a receiver to improve AssistNow Autonomous operation.					
Message Structure		Header	Class	ID	Length (Bytes)	Payload	Checksum
		0xB5 0x62	0x13	0x40	72	see below	CK_A CK_B
Payload Contents:							
Byte Offset	Number Format	Scaling	Name	Unit	Description		
0	U1	-	type	-	Message type (0x30 for this type)		
1	U1	-	version	-	Message version (0x00 for this version)		
2	U1[2]	-	reserved1	-	Reserved		
4	U2	-	d2kRef	d	reference time (days since 1.1.2000 12.00h UTC)		
6	U2	-	d2kMax	d	expiration time (days since 1.1.2000 12.00h UTC)		
8	I4	2 ⁻³⁰	xpP0	arcsec	x _p t ⁰ polynomial term (offset)		
12	I4	2 ⁻³⁰	xpP1	arcsec/d	x _p t ¹ polynomial term (drift)		
16	I4	2 ⁻³⁰	ypP0	arcsec	y _p t ⁰ polynomial term (offset)		
20	I4	2 ⁻³⁰	ypP1	arcsec/d	y _p t ¹ polynomial term (drift)		
24	I4	2 ⁻²⁵	dUT1	s	dUT1 t ⁰ polynomial term (offset)		
28	I4	2 ⁻³⁰	ddUT1	s/d	dUT1 t ¹ polynomial term (drift)		
32	U1[40]	-	reserved2	-	Reserved		

31.16.10 UBX-MGA-QZSS (0x13 0x05)

31.16.10.1 UBX-MGA-QZSS-EPH

Message		UBX-MGA-QZSS-EPH					
Description		QZSS Ephemeris Assistance					
Firmware		Supported on: <ul style="list-style-type: none"> u-blox 8 / u-blox M8 from protocol version 15 up to version 23.01 					
Type		Input					
Comment		This message allows the delivery of QZSS ephemeris assistance to a receiver. See the description of AssistNow Online for details.					
Message Structure		Header	Class	ID	Length (Bytes)	Payload	Checksum
		0xB5 0x62	0x13	0x05	68	see below	CK_A CK_B
Payload Contents:							
Byte Offset	Number Format	Scaling	Name	Unit	Description		
0	U1	-	type	-	Message type (0x01 for this type)		

MGA-QZSS continued

Byte Offset	Number Format	Scaling	Name	Unit	Description
1	U1	-	version	-	Message version (0x00 for this version)
2	U1	-	svId	-	QZSS Satellite identifier (see Satellite Numbering), Range 1-5
3	U1	-	reserved1	-	Reserved
4	U1	-	fitInterval	-	Fit interval flag
5	U1	-	uraIndex	-	URA index
6	U1	-	svHealth	-	SV health
7	I1	2 ⁻³¹	tgdc	s	Group delay differential
8	U2	-	iodc	-	IODC
10	U2	2 ⁴	toc	s	Clock data reference time
12	U1	-	reserved2	-	Reserved
13	I1	2 ⁻⁵⁵	af2	s/s squared	Time polynomial coefficient 2
14	I2	2 ⁻⁴³	af1	s/s	Time polynomial coefficient 1
16	I4	2 ⁻³¹	af0	s	Time polynomial coefficient 0
20	I2	2 ⁻⁵	crs	m	Crs
22	I2	2 ⁻⁴³	deltaN	semi-circles/s	Mean motion difference from computed value
24	I4	2 ⁻³¹	m0	semi-circles	Mean anomaly at reference time
28	I2	2 ⁻²⁹	cuc	radians	Amp of cosine harmonic corr term to arg of lat
30	I2	2 ⁻²⁹	cus	radians	Amp of sine harmonic corr term to arg of lat
32	U4	2 ⁻³³	e	-	eccentricity
36	U4	2 ⁻¹⁹	sqrtA	m ^{0.5}	Square root of the semi-major axis A
40	U2	2 ⁴	toe	s	Reference time of ephemeris
42	I2	2 ⁻²⁹	cic	radians	Amp of cos harmonic corr term to angle of inclination
44	I4	2 ⁻³¹	omega0	semi-circles	Long of asc node of orbit plane at weekly epoch
48	I2	2 ⁻²⁹	cis	radians	Amp of sine harmonic corr term to angle of inclination
50	I2	2 ⁻⁵	crc	m	Amp of cosine harmonic corr term to orbit radius
52	I4	2 ⁻³¹	i0	semi-circles	Inclination angle at reference time
56	I4	2 ⁻³¹	omega	semi-circles	Argument of perigee
60	I4	2 ⁻⁴³	omegaDot	semi-circles/s	Rate of right ascension
64	I2	2 ⁻⁴³	idot	semi-circles/s	Rate of inclination angle
66	U1[2]	-	reserved3	-	Reserved

31.16.10.2 UBX-MGA-QZSS-ALM

Message		UBX-MGA-QZSS-ALM					
Description		QZSS Almanac Assistance					
Firmware		Supported on: <ul style="list-style-type: none"> • u-blox 8 / u-blox M8 from protocol version 15 up to version 23.01 					
Type		Input					
Comment		This message allows the delivery of QZSS almanac assistance to a receiver. See the description of AssistNow Online for details.					
Message Structure		Header	Class	ID	Length (Bytes)	Payload	Checksum
		0xB5 0x62	0x13	0x05	36	see below	CK_A CK_B
Payload Contents:							
Byte Offset	Number Format	Scaling	Name	Unit	Description		
0	U1	-	type	-	Message type (0x02 for this type)		
1	U1	-	version	-	Message version (0x00 for this version)		
2	U1	-	svId	-	QZSS Satellite identifier (see Satellite Numbering), Range 1-5		
3	U1	-	svHealth	-	Almanac SV health information		
4	U2	2 ⁻²¹	e	-	Almanac eccentricity		
6	U1	-	almWNa	week	Reference week number of almanac (the 8 bit WNa field)		
7	U1	2 ¹²	toa	s	Reference time of almanac		
8	I2	2 ⁻¹⁹	deltaI	semi-circles	Delta inclination angle at reference time		
10	I2	2 ⁻³⁸	omegaDot	semi-circles/s	Almanac rate of right ascension		
12	U4	2 ⁻¹¹	sqrtA	m ^{0.5}	Almanac square root of the semi-major axis A		
16	I4	2 ⁻²³	omega0	semi-circles	Almanac long of asc node of orbit plane at weekly		
20	I4	2 ⁻²³	omega	semi-circles	Almanac argument of perigee		
24	I4	2 ⁻²³	m0	semi-circles	Almanac mean anomaly at reference time		
28	I2	2 ⁻²⁰	af0	s	Almanac time polynomial coefficient 0 (8 MSBs)		
30	I2	2 ⁻³⁸	af1	s/s	Almanac time polynomial coefficient 1		
32	U1[4]	-	reserved1	-	Reserved		

31.16.10.3 UBX-MGA-QZSS-HEALTH

<i>Message</i>	UBX-MGA-QZSS-HEALTH					
<i>Description</i>	QZSS Health Assistance					
<i>Firmware</i>	Supported on: <ul style="list-style-type: none"> • u-blox 8 / u-blox M8 from protocol version 15 up to version 23.01 					
<i>Type</i>	Input					
<i>Comment</i>	This message allows the delivery of QZSS health assistance to a receiver. See the description of AssistNow Online for details.					
<i>Message Structure</i>	<i>Header</i>	<i>Class</i>	<i>ID</i>	<i>Length (Bytes)</i>	<i>Payload</i>	<i>Checksum</i>
	0xB5 0x62	0x13	0x05	12	<i>see below</i>	CK_A CK_B
<i>Payload Contents:</i>						
<i>Byte Offset</i>	<i>Number Format</i>	<i>Scaling</i>	<i>Name</i>	<i>Unit</i>	<i>Description</i>	
0	U1	-	type	-	Message type (0x04 for this type)	
1	U1	-	version	-	Message version (0x00 for this version)	
2	U1[2]	-	reserved1	-	Reserved	
4	U1[5]	-	healthCode	-	Each byte represents a QZSS SV (1-5). The 6 LSBs of each byte contains the 6 bit health code from subframes 4/5, data ID = 3, SV ID = 51	
9	U1[3]	-	reserved2	-	Reserved	

31.17 UBX-MON (0x0A)

Monitoring Messages: i.e. Communication Status, CPU Load, Stack Usage, Task Status.

Messages in the MON class are used to report the receiver status, such as CPU load, stack usage, I/O subsystem statistics etc.

31.17.1 UBX-MON-GNSS (0x0A 0x28)

31.17.1.1 Information message major GNSS selection

Message	MON-GNSS					
Description	Information message major GNSS selection					
Firmware	Supported on: <ul style="list-style-type: none"> • u-blox 8 / u-blox M8 from protocol version 15 up to version 23.01 					
Type	Polled					
Comment	This message reports major GNSS selection. It does this by means of bit masks in U1 fields. Each bit in a bit mask corresponds to one major GNSS. Augmentation systems are not reported.					
Message Structure	Header	Class	ID	Length (Bytes)	Payload	Checksum
	0xB5 0x62	0x0A	0x28	8	see below	CK_A CK_B
Payload Contents:						
Byte Offset	Number Format	Scaling	Name	Unit	Description	
0	U1	-	version	-	Message version (0x01 for this version)	
1	X1	-	supported	-	A bit mask showing the major GNSS that can be supported by this receiver (see graphic below)	
2	X1	-	defaultGnss	-	A bit mask showing the default major GNSS selection. If the default major GNSS selection is currently configured in the efuse for this receiver, it takes precedence over the default major GNSS selection configured in the executing firmware of this receiver. (see graphic below)	
3	X1	-	enabled	-	A bit mask showing the current major GNSS selection enabled for this receiver (see graphic below)	
4	U1	-	simultaneous	-	Maximum number of concurrent major GNSS that can be supported by this receiver	
5	U1[3]	-	reserved1	-	Reserved	

Bitfield supported

This graphic explains the bits of supported

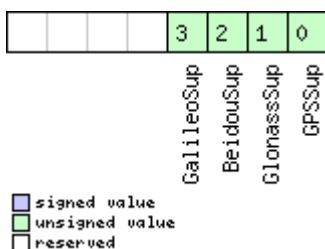

Bitfield supported Description continued

Name	Description
GPSSup	GPS is supported
GlonassSup	GLONASS is supported
BeidouSup	BeiDou is supported
GalileoSup	Galileo is supported

Bitfield defaultGnss

This graphic explains the bits of defaultGnss

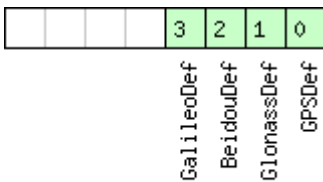

- signed value
- unsigned value
- reserved

Name	Description
GPSDef	GPS is default-enabled
GlonassDef	GLONASS is default-enabled
BeidouDef	BeiDou is default-enabled
GalileoDef	Galileo is default-enabled

Bitfield enabled

This graphic explains the bits of enabled

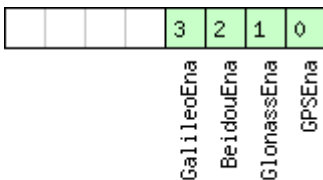

- signed value
- unsigned value
- reserved

Name	Description
GPSEna	GPS is enabled
GlonassEna	GLONASS is enabled
BeidouEna	BeiDou is enabled
GalileoEna	Galileo is enabled

31.17.2 UBX-MON-HW2 (0x0A 0x0B)

31.17.2.1 Extended Hardware Status

Message	MON-HW2					
Description	Extended Hardware Status					
Firmware	Supported on: <ul style="list-style-type: none"> u-blox 8 / u-blox M8 from protocol version 15 up to version 23.01 					
Type	Periodic/Polled					
Comment	Status of different aspects of the hardware such as Imbalance, Low-Level Configuration and POST Results. The first four parameters of this message represent the complex signal from the RF front end. The following rules of thumb apply: <ul style="list-style-type: none"> The smaller the absolute value of the variable <code>ofsI</code> and <code>ofsQ</code>, the better. Ideally, the magnitude of the I-part (<code>magI</code>) and the Q-part (<code>magQ</code>) of the complex signal should be the same. 					
Message Structure	Header	Class	ID	Length (Bytes)	Payload	Checksum
	0xB5 0x62	0x0A	0x0B	28	see below	CK_A CK_B
Payload Contents:						
Byte Offset	Number Format	Scaling	Name	Unit	Description	
0	I1	-	<code>ofsI</code>	-	Imbalance of I-part of complex signal, scaled (-128 = max. negative imbalance, 127 = max. positive imbalance)	
1	U1	-	<code>magI</code>	-	Magnitude of I-part of complex signal, scaled (0 = no signal, 255 = max. magnitude)	
2	I1	-	<code>ofsQ</code>	-	Imbalance of Q-part of complex signal, scaled (-128 = max. negative imbalance, 127 = max. positive imbalance)	
3	U1	-	<code>magQ</code>	-	Magnitude of Q-part of complex signal, scaled (0 = no signal, 255 = max. magnitude)	
4	U1	-	<code>cfgSource</code>	-	Source of low-level configuration (114 = ROM, 111 = OTP, 112 = config pins, 102 = flash image)	
5	U1[3]	-	<code>reserved1</code>	-	Reserved	
8	U4	-	<code>lowLevCfg</code>	-	Low-level configuration (obsolete in protocol versions greater than 15)	
12	U1[8]	-	<code>reserved2</code>	-	Reserved	
20	U4	-	<code>postStatus</code>	-	POST status word	
24	U1[4]	-	<code>reserved3</code>	-	Reserved	

31.17.3 UBX-MON-HW (0x0A 0x09)

31.17.3.1 Hardware Status

Message	MON-HW					
Description	Hardware Status					
Firmware	Supported on: <ul style="list-style-type: none"> u-blox 8 / u-blox M8 from protocol version 15 up to version 23.01 					
Type	Periodic/Polled					
Comment	Status of different aspect of the hardware, such as Antenna, PIO/Peripheral Pins, Noise Level, Automatic Gain Control (AGC)					
Message Structure	Header	Class	ID	Length (Bytes)	Payload	Checksum
	0xB5 0x62	0x0A	0x09	60	see below	CK_A CK_B
Payload Contents:						
Byte Offset	Number Format	Scaling	Name	Unit	Description	
0	X4	-	pinSel	-	Mask of Pins Set as Peripheral/PIO	
4	X4	-	pinBank	-	Mask of Pins Set as Bank A/B	
8	X4	-	pinDir	-	Mask of Pins Set as Input/Output	
12	X4	-	pinVal	-	Mask of Pins Value Low/High	
16	U2	-	noisePerMS	-	Noise Level as measured by the GPS Core	
18	U2	-	agcCnt	-	AGC Monitor (counts SIGHI xor SIGLO, range 0 to 8191)	
20	U1	-	aStatus	-	Status of the Antenna Supervisor State Machine (0=INIT, 1=DONTKNOW, 2=OK, 3=SHORT, 4=OPEN)	
21	U1	-	aPower	-	Current PowerStatus of Antenna (0=OFF, 1=ON, 2=DONTKNOW)	
22	X1	-	flags	-	Flags (see graphic below)	
23	U1	-	reserved1	-	Reserved	
24	X4	-	usedMask	-	Mask of Pins that are used by the Virtual Pin Manager	
28	U1[17]	-	VP	-	Array of Pin Mappings for each of the 17 Physical Pins	
45	U1	-	jamInd	-	CW Jamming indicator, scaled (0 = no CW jamming, 255 = strong CW jamming)	
46	U1[2]	-	reserved2	-	Reserved	
48	X4	-	pinIrq	-	Mask of Pins Value using the PIO Irq	
52	X4	-	pullH	-	Mask of Pins Value using the PIO Pull High Resistor	
56	X4	-	pullL	-	Mask of Pins Value using the PIO Pull Low Resistor	

Bitfield flags

This graphic explains the bits of flags

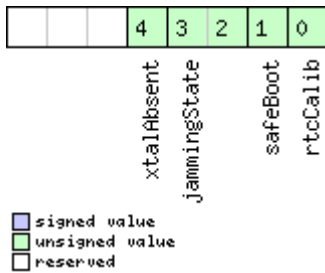

Name	Description
rtcCalib	RTC is calibrated
safeBoot	safeBoot mode (0 = inactive, 1 = active)
jammingState	output from Jamming/Interference Monitor (0 = unknown or feature disabled, 1 = ok - no significant jamming, 2 = warning - interference visible but fix OK, 3 = critical - interference visible and no fix)
xtalAbsent	RTC xtal has been determined to be absent. (not supported in protocol versions less than 18)

31.17.4 UBX-MON-IO (0x0A 0x02)

31.17.4.1 I/O Subsystem Status

Message	MON-IO					
Description	I/O Subsystem Status					
Firmware	Supported on: <ul style="list-style-type: none"> u-blox 8 / u-blox M8 from protocol version 15 up to version 23.01 					
Type	Periodic/Polled					
Comment	The size of the message is determined by the number of ports 'N' the receiver supports, i.e. on u-blox 5 the number of ports is 6.					
Message Structure	Header	Class	ID	Length (Bytes)	Payload	Checksum
	0xB5 0x62	0x0A	0x02	0 + 20*N	see below	CK_A CK_B
Payload Contents:						
Byte Offset	Number Format	Scaling	Name	Unit	Description	
Start of repeated block (N times)						
N*20	U4	-	rxBytes	bytes	Number of bytes ever received	
4 + 20*N	U4	-	txBytes	bytes	Number of bytes ever sent	
8 + 20*N	U2	-	parityErrs	-	Number of 100ms timeslots with parity errors	
10 + 20*N	U2	-	framingErrs	-	Number of 100ms timeslots with framing errors	
12 + 20*N	U2	-	overrunErrs	-	Number of 100ms timeslots with overrun errors	
14 + 20*N	U2	-	breakCond	-	Number of 100ms timeslots with break conditions	
16 + 20*N	U1	-	rxBusy	-	Flag is receiver is busy	
17 + 20*N	U1	-	txBusy	-	Flag is transmitter is busy	
18 + 20*N	U1[2]	-	reserved1	-	Reserved	
End of repeated block						

31.17.5 UBX-MON-MSGPP (0x0A 0x06)

31.17.5.1 Message Parse and Process Status

<i>Message</i>	MON-MSGPP					
<i>Description</i>	Message Parse and Process Status					
<i>Firmware</i>	Supported on: <ul style="list-style-type: none"> u-blox 8 / u-blox M8 from protocol version 15 up to version 23.01 					
<i>Type</i>	Periodic/Polled					
<i>Comment</i>	-					
<i>Message Structure</i>	<i>Header</i>	<i>Class</i>	<i>ID</i>	<i>Length (Bytes)</i>	<i>Payload</i>	<i>Checksum</i>
	0xB5 0x62	0x0A	0x06	120	see below	CK_A CK_B
<i>Payload Contents:</i>						
<i>Byte Offset</i>	<i>Number Format</i>	<i>Scaling</i>	<i>Name</i>	<i>Unit</i>	<i>Description</i>	
0	U2[8]	-	msg1	msgs	Number of successfully parsed messages for each protocol on port0	
16	U2[8]	-	msg2	msgs	Number of successfully parsed messages for each protocol on port1	
32	U2[8]	-	msg3	msgs	Number of successfully parsed messages for each protocol on port2	
48	U2[8]	-	msg4	msgs	Number of successfully parsed messages for each protocol on port3	
64	U2[8]	-	msg5	msgs	Number of successfully parsed messages for each protocol on port4	
80	U2[8]	-	msg6	msgs	Number of successfully parsed messages for each protocol on port5	
96	U4[6]	-	skipped	bytes	Number skipped bytes for each port	

31.17.6 UBX-MON-PATCH (0x0A 0x27)

31.17.6.1 Poll Request for installed patches

<i>Message</i>	MON-PATCH					
<i>Description</i>	Poll Request for installed patches					
<i>Firmware</i>	Supported on: <ul style="list-style-type: none"> u-blox 8 / u-blox M8 from protocol version 15 up to version 23.01 					
<i>Type</i>	Poll Request					
<i>Comment</i>	-					
<i>Message Structure</i>	<i>Header</i>	<i>Class</i>	<i>ID</i>	<i>Length (Bytes)</i>	<i>Payload</i>	<i>Checksum</i>
	0xB5 0x62	0x0A	0x27	0	see below	CK_A CK_B
<i>No payload</i>						

31.17.6.2 Output information about installed patches.

Message	MON-PATCH					
Description	Output information about installed patches.					
Firmware	Supported on: <ul style="list-style-type: none"> • u-blox 8 / u-blox M8 from protocol version 15 up to version 23.01 					
Type	Polled					
Comment	-					
Message Structure	Header	Class	ID	Length (Bytes)	Payload	Checksum
	0xB5 0x62	0x0A	0x27	4 + 16*nEntries	see below	CK_A CK_B
Payload Contents:						
Byte Offset	Number Format	Scaling	Name	Unit	Description	
0	U2	-	version	-	Type of the message. 0x1 for this one.	
2	U2	-	nEntries	-	The number of patches that is output.	
Start of repeated block (nEntries times)						
4 + 16*N	X4	-	patchInfo	-	Additional information about the patch not stated in the patch header. (see graphic below)	
8 + 16*N	U4	-	comparatorNumber	-	The number of the comparator.	
12 + 16*N	U4	-	patchAddress	-	The address that the targeted by the patch.	
16 + 16*N	U4	-	patchData	-	The data that will be inserted at the patchAddress.	
End of repeated block						

Bitfield patchInfo

This graphic explains the bits of patchInfo

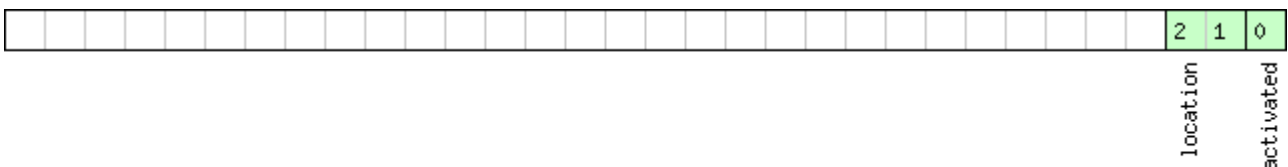

- signed value
- unsigned value
- reserved

Name	Description
activated	1: the patch is active. 0: otherwise.
location	Indicates where the patch is stored. 0: eFuse, 1: ROM, 2: BBR, 3: file system.

31.17.7 UBX-MON-RXBUF (0x0A 0x07)

31.17.7.1 Receiver Buffer Status

Message	MON-RXBUF					
Description	Receiver Buffer Status					
Firmware	Supported on: <ul style="list-style-type: none"> u-blox 8 / u-blox M8 from protocol version 15 up to version 23.01 					
Type	Periodic/Polled					
Comment	-					
Message Structure	Header	Class	ID	Length (Bytes)	Payload	Checksum
	0xB5 0x62	0x0A	0x07	24	see below	CK_A CK_B
Payload Contents:						
Byte Offset	Number Format	Scaling	Name	Unit	Description	
0	U2[6]	-	pending	bytes	Number of bytes pending in receiver buffer for each target	
12	U1[6]	-	usage	%	Maximum usage receiver buffer during the last sysmon period for each target	
18	U1[6]	-	peakUsage	%	Maximum usage receiver buffer for each target	

31.17.8 UBX-MON-RXR (0x0A 0x21)

31.17.8.1 Receiver Status Information

Message	MON-RXR					
Description	Receiver Status Information					
Firmware	Supported on: <ul style="list-style-type: none"> u-blox 8 / u-blox M8 from protocol version 15 up to version 23.01 					
Type	Output					
Comment	The receiver ready message is sent when the receiver changes from or to backup mode.					
Message Structure	Header	Class	ID	Length (Bytes)	Payload	Checksum
	0xB5 0x62	0x0A	0x21	1	see below	CK_A CK_B
Payload Contents:						
Byte Offset	Number Format	Scaling	Name	Unit	Description	
0	X1	-	flags	-	Receiver status flags (see graphic below)	

Bitfield flags

This graphic explains the bits of flags

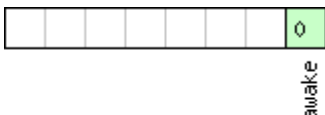

- signed value
- unsigned value
- reserved

Name	Description
awake	not in Backup mode

Bitfield intOsc Description continued

Name	Description
<i>Name</i>	<i>Description</i>
intOscState	State of the oscillator: 0: autonomous operation 1: calibration ongoing 2: oscillator is steered by the host 3: idle state
intOscCalib	1 = oscillator gain is calibrated
intOscDisc	1 = signal is disciplined

Bitfield extOsc

This graphic explains the bits of extOsc

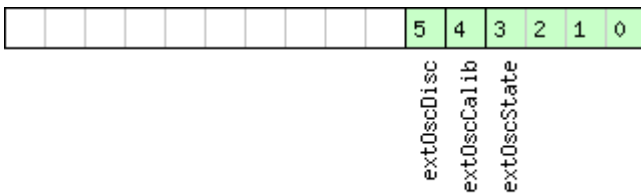

signed value
 unsigned value
 reserved

Name	Description
extOscState	State of the oscillator: 0: autonomous operation 1: calibration ongoing 2: oscillator is steered by the host 3: idle state
extOscCalib	1 = oscillator gain is calibrated
extOscDisc	1 = signal is disciplined

Bitfield gnss

This graphic explains the bits of gnss

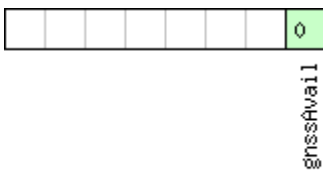

signed value
 unsigned value
 reserved

Name	Description
gnssAvail	1 = GNSS is present

Bitfield extInt0

This graphic explains the bits of extInt0

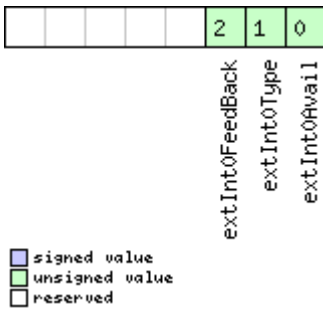

Name	Description
extInt0Avail	1 = signal present at this input
extInt0Type	Source type: 0: frequency 1: time
extInt0FeedBack	This source is used as feedback of the external oscillator

Bitfield extInt1

This graphic explains the bits of extInt1

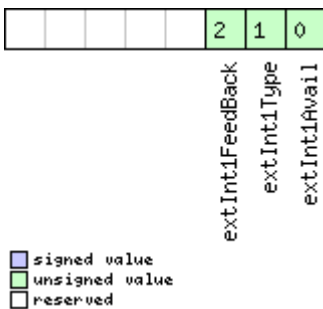

Name	Description
extInt1Avail	1 = signal present at this input
extInt1Type	Source type: 0: frequency 1: time
extInt1FeedBack	This source is used as feedback of the external oscillator

31.17.10 UBX-MON-TXBUF (0x0A 0x08)

31.17.10.1 Transmitter Buffer Status

Message	MON-TXBUF					
Description	Transmitter Buffer Status					
Firmware	Supported on: <ul style="list-style-type: none"> u-blox 8 / u-blox M8 from protocol version 15 up to version 23.01 					
Type	Periodic/Polled					
Comment	-					
Message Structure	Header	Class	ID	Length (Bytes)	Payload	Checksum
	0xB5 0x62	0x0A	0x08	28	see below	CK_A CK_B
Payload Contents:						
Byte Offset	Number Format	Scaling	Name	Unit	Description	
0	U2[6]	-	pending	bytes	Number of bytes pending in transmitter buffer for each target	
12	U1[6]	-	usage	%	Maximum usage transmitter buffer during the last sysmon period for each target	
18	U1[6]	-	peakUsage	%	Maximum usage transmitter buffer for each target	
24	U1	-	tUsage	%	Maximum usage of transmitter buffer during the last sysmon period for all targets	
25	U1	-	tPeakusage	%	Maximum usage of transmitter buffer for all targets	
26	X1	-	errors	-	Error bitmask (see graphic below)	
27	U1	-	reserved1	-	Reserved	

Bitfield errors

This graphic explains the bits of errors

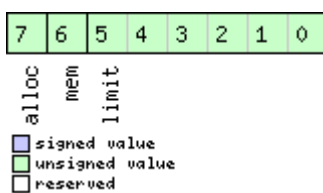

Name	Description
limit	Buffer limit of corresponding target reached
mem	Memory Allocation error
alloc	Allocation error (TX buffer full)

31.17.11 UBX-MON-VER (0x0A 0x04)

31.17.11.1 Poll Receiver/Software Version

Message	MON-VER					
Description	Poll Receiver/Software Version					
Firmware	Supported on: <ul style="list-style-type: none"> u-blox 8 / u-blox M8 from protocol version 15 up to version 23.01 					
Type	Poll Request					
Comment	-					
Message Structure	Header	Class	ID	Length (Bytes)	Payload	Checksum
	0xB5 0x62	0x0A	0x04	0	see below	CK_A CK_B
No payload						

31.17.11.2 Receiver/Software Version

Message	MON-VER					
Description	Receiver/Software Version					
Firmware	Supported on: <ul style="list-style-type: none"> u-blox 8 / u-blox M8 from protocol version 15 up to version 23.01 					
Type	Polled					
Comment	-					
Message Structure	Header	Class	ID	Length (Bytes)	Payload	Checksum
	0xB5 0x62	0x0A	0x04	40 + 30*N	see below	CK_A CK_B
Payload Contents:						
Byte Offset	Number Format	Scaling	Name	Unit	Description	
0	CH[30]	-	swVersion	-	Zero-terminated Software Version String.	
30	CH[10]	-	hwVersion	-	Zero-terminated Hardware Version String	
Start of repeated block (N times)						
40 + 30*N	CH[30]	-	extension	-	Extended software information strings. A series of zero-terminated strings. Each extension field is 30 characters long and contains varying software information. Not all extension fields may appear. Example reported information can be: the software version string of the underlying ROM (when the receiver's firmware is running from flash), the firmware version, the supported protocol version , the module identifier, the Flash Information Structure (FIS) file information, the supported major GNSS , the supported augmentation systems .	
End of repeated block						

31.18 UBX-NAV (0x01)

Navigation Results Messages: i.e. Position, Speed, Time, Acceleration, Heading, DOP, SVs used.

Messages in the NAV class are used to output navigation data such as position, altitude and velocity in a number of formats. Additionally, status flags and accuracy figures are output. The messages are generated with the configured navigation/measurement rate.

31.18.1 UBX-NAV-AOPSTATUS (0x01 0x60)

31.18.1.1 AssistNow Autonomous Status

Message	NAV-AOPSTATUS					
Description	AssistNow Autonomous Status					
Firmware	Supported on: <ul style="list-style-type: none"> • u-blox 8 / u-blox M8 from protocol version 15 up to version 23.01 					
Type	Periodic/Polled					
Comment	This message provides information on the status of the <i>AssistNow Autonomous</i> subsystem on the receiver. For example, a host application can determine the optimal time to shut down the receiver by monitoring the <code>status</code> field for a steady 0. See the chapter AssistNow Autonomous in the receiver description for details on this feature.					
Message Structure	Header	Class	ID	Length (Bytes)	Payload	Checksum
	0xB5 0x62	0x01	0x60	16	see below	CK_A CK_B
Payload Contents:						
Byte Offset	Number Format	Scaling	Name	Unit	Description	
0	U4	-	iTOW	ms	GPS time of week of the navigation epoch . See the description of iTOW for details.	
4	U1	-	aopCfg	-	<i>AssistNow Autonomous</i> configuration (see graphic below)	
5	U1	-	status	-	<i>AssistNow Autonomous</i> subsystem is idle (0) or running (not 0)	
6	U1[10]	-	reserved1	-	Reserved	

Bitfield aopCfg

This graphic explains the bits of `aopCfg`

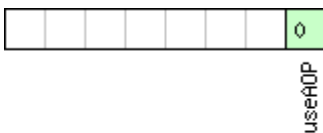

- signed value
- unsigned value
- reserved

Name	Description
useAOP	AOP enabled flag

31.18.2 UBX-NAV-ATT (0x01 0x05)

31.18.2.1 Attitude Solution

Message	NAV-ATT					
Description	Attitude Solution					
Firmware	Supported on: <ul style="list-style-type: none"> u-blox 8 / u-blox M8 from protocol version 19 up to version 23.01 (only with UDR or ADR products) 					
Type	Periodic/Polled					
Comment	This message outputs the attitude solution as roll, pitch and heading angles. More details about vehicle attitude can be found in the Vehicle Attitude Output (ADR) section for ADR products. More details about vehicle attitude can be found in the Vehicle Attitude Output (UDR) section for UDR products.					
Message Structure	Header	Class	ID	Length (Bytes)	Payload	Checksum
	0xB5 0x62	0x01	0x05	32	see below	CK_A CK_B
Payload Contents:						
Byte Offset	Number Format	Scaling	Name	Unit	Description	
0	U4	-	iTOW	ms	GPS time of week of the navigation epoch . See the description of iTOW for details.	
4	U1	-	version	-	Message version (0 for this version)	
5	U1[3]	-	reserved1	-	Reserved	
8	I4	1e-5	roll	deg	Vehicle roll.	
12	I4	1e-5	pitch	deg	Vehicle pitch.	
16	I4	1e-5	heading	deg	Vehicle heading.	
20	U4	1e-5	accRoll	deg	Vehicle roll accuracy (if null, roll angle is not available).	
24	U4	1e-5	accPitch	deg	Vehicle pitch accuracy (if null, pitch angle is not available).	
28	U4	1e-5	accHeading	deg	Vehicle heading accuracy (if null, heading angle is not available).	

31.18.3 UBX-NAV-CLOCK (0x01 0x22)

31.18.3.1 Clock Solution

Message	NAV-CLOCK					
Description	Clock Solution					
Firmware	Supported on: <ul style="list-style-type: none"> u-blox 8 / u-blox M8 from protocol version 15 up to version 23.01 					
Type	Periodic/Polled					
Comment	-					
Message Structure	Header	Class	ID	Length (Bytes)	Payload	Checksum
	0xB5 0x62	0x01	0x22	20	see below	CK_A CK_B
Payload Contents:						
Byte Offset	Number Format	Scaling	Name	Unit	Description	

NAV-CLOCK continued

Byte Offset	Number Format	Scaling	Name	Unit	Description
0	U4	-	iTOW	ms	GPS time of week of the navigation epoch . See the description of iTOW for details.
4	I4	-	clkB	ns	Clock bias
8	I4	-	clkD	ns/s	Clock drift
12	U4	-	tAcc	ns	Time accuracy estimate
16	U4	-	fAcc	ps/s	Frequency accuracy estimate

31.18.4 UBX-NAV-DGPS (0x01 0x31)
31.18.4.1 DGPS Data Used for NAV

Message	NAV-DGPS					
Description	DGPS Data Used for NAV					
Firmware	Supported on: <ul style="list-style-type: none"> • u-blox 8 / u-blox M8 from protocol version 15 up to version 23.01 					
Type	Periodic/Polled					
Comment	This message outputs the DGPS correction data that has been applied to the current NAV Solution. See also the notes on the RTCM protocol .					
Message Structure	Header	Class	ID	Length (Bytes)	Payload	Checksum
	0xB5 0x62	0x01	0x31	16 + 12*numCh	see below	CK_A CK_B
Payload Contents:						
Byte Offset	Number Format	Scaling	Name	Unit	Description	
0	U4	-	iTOW	ms	GPS time of week of the navigation epoch . See the description of iTOW for details.	
4	I4	-	age	ms	Age of newest correction data	
8	I2	-	baseId	-	DGPS base station identifier	
10	I2	-	baseHealth	-	DGPS base station health status	
12	U1	-	numCh	-	Number of channels for which correction data is following	
13	U1	-	status	-	DGPS correction type status: 0x00: none 0x01: PR+PRR correction	
14	U1[2]	-	reserved1	-	Reserved	
Start of repeated block (numCh times)						
16 + 12*N	U1	-	svid	-	Satellite ID	
17 + 12*N	X1	-	flags	-	Channel number and usage (see graphic below)	
18 + 12*N	U2	-	ageC	ms	Age of latest correction data	
20 + 12*N	R4	-	prc	m	Pseudorange correction	
24 + 12*N	R4	-	prrc	m/s	Pseudorange rate correction	
End of repeated block						

Bitfield flags

This graphic explains the bits of flags

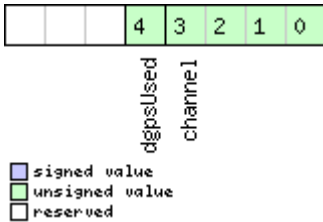

Name	Description
channel1	GPS channel number this SV is on. Channel numbers in the firmware greater than 15 are displayed as having channel number 15
dgpsUsed	1 = DGPS used for this SV

31.18.5 UBX-NAV-DOP (0x01 0x04)

31.18.5.1 Dilution of precision

Message	NAV-DOP					
Description	Dilution of precision					
Firmware	Supported on: <ul style="list-style-type: none"> • u-blox 8 / u-blox M8 from protocol version 15 up to version 23.01 					
Type	Periodic/Polled					
Comment	<ul style="list-style-type: none"> • DOP values are dimensionless. • All DOP values are scaled by a factor of 100. If the unit transmits a value of e.g. 156, the DOP value is 1.56. 					
Message Structure	Header	Class	ID	Length (Bytes)	Payload	Checksum
	0xB5 0x62	0x01	0x04	18	see below	CK_A CK_B
Payload Contents:						
Byte Offset	Number Format	Scaling	Name	Unit	Description	
0	U4	-	iTOW	ms	GPS time of week of the navigation epoch . See the description of iTOW for details.	
4	U2	0.01	gDOP	-	Geometric DOP	
6	U2	0.01	pDOP	-	Position DOP	
8	U2	0.01	tDOP	-	Time DOP	
10	U2	0.01	vDOP	-	Vertical DOP	
12	U2	0.01	hDOP	-	Horizontal DOP	
14	U2	0.01	nDOP	-	Northing DOP	
16	U2	0.01	eDOP	-	Easting DOP	

31.18.6 UBX-NAV-EOE (0x01 0x61)

31.18.6.1 End Of Epoch

Message		NAV-EOE					
Description		End Of Epoch					
Firmware		Supported on: <ul style="list-style-type: none"> • u-blox 8 / u-blox M8 from protocol version 18 up to version 23.01 					
Type		Periodic					
Comment		This message is intended to be used as a marker to collect all navigation messages of an epoch. It is output after all enabled NAV class messages (except NAV-HNR) and after all enabled NMEA messages.					
Message Structure		Header	Class	ID	Length (Bytes)	Payload	Checksum
		0xB5 0x62	0x01	0x61	4	see below	CK_A CK_B
Payload Contents:							
Byte Offset	Number Format	Scaling	Name	Unit	Description		
0	U4	-	iTOW	ms	GPS time of week of the navigation epoch . See the description of iTOW for details.		

31.18.7 UBX-NAV-GEOFENCE (0x01 0x39)

31.18.7.1 Geofencing status

Message		NAV-GEOFENCE					
Description		Geofencing status					
Firmware		Supported on: <ul style="list-style-type: none"> • u-blox 8 / u-blox M8 from protocol version 18 up to version 23.01 					
Type		Periodic/Polled					
Comment		This message outputs the evaluated states of all configured geofences for the current epoch's position. See the Geofencing description for feature details.					
Message Structure		Header	Class	ID	Length (Bytes)	Payload	Checksum
		0xB5 0x62	0x01	0x39	8 + 2*numFences	see below	CK_A CK_B
Payload Contents:							
Byte Offset	Number Format	Scaling	Name	Unit	Description		
0	U4	-	iTOW	ms	GPS time of week of the navigation epoch . See the description of iTOW for details.		
4	U1	-	version	-	Message version (0x00 for this version)		
5	U1	-	status	-	Geofencing status 0 - Geofencing not available or not reliable 1 - Geofencing active		
6	U1	-	numFences	-	Number of geofences		
7	U1	-	combState	-	Combined (logical OR) state of all geofences 0 - Unknown 1 - Inside 2 - Outside		
Start of repeated block (numFences times)							

NAV-GEOFENCE continued

Byte Offset	Number Format	Scaling	Name	Unit	Description
8 + 2*N	U1	-	state	-	Geofence state 0 - Unknown 1 - Inside 2 - Outside
9 + 2*N	U1[1]	-	reserved1	-	Reserved
End of repeated block					

31.18.8 UBX-NAV-HPPOSECEF (0x01 0x13)
31.18.8.1 High Precision Position Solution in ECEF

Message	NAV-HPPOSECEF					
Description	High Precision Position Solution in ECEF					
Firmware	Supported on: <ul style="list-style-type: none"> u-blox 8 / u-blox M8 from protocol version 20.01 up to version 23.01 					
Type	Periodic/Polled					
Comment	See important comments concerning validity of position given in section Navigation Output Filters . -					
Message Structure	Header	Class	ID	Length (Bytes)	Payload	Checksum
	0xB5 0x62	0x01	0x13	28	see below	CK_A CK_B
Payload Contents:						
Byte Offset	Number Format	Scaling	Name	Unit	Description	
0	U1	-	version	-	Message version (0 for this version)	
1	U1[3]	-	reserved1	-	Reserved	
4	U4	-	iTOW	ms	GPS time of week of the navigation epoch . See the description of iTOW for details.	
8	I4	-	ecefX	cm	ECEF X coordinate	
12	I4	-	ecefY	cm	ECEF Y coordinate	
16	I4	-	ecefZ	cm	ECEF Z coordinate	
20	I1	0.1	ecefXHp	mm	High precision component of ECEF X coordinate. Must be in the range of -99..+99. Precise coordinate in cm = ecefX + (ecefXHp * 1e-2).	
21	I1	0.1	ecefYHp	mm	High precision component of ECEF Y coordinate. Must be in the range of -99..+99. Precise coordinate in cm = ecefY + (ecefYHp * 1e-2).	
22	I1	0.1	ecefZHp	mm	High precision component of ECEF Z coordinate. Must be in the range of -99..+99. Precise coordinate in cm = ecefZ + (ecefZHp * 1e-2).	
23	U1	-	reserved2	-	Reserved	
24	U4	0.1	pAcc	mm	Position Accuracy Estimate	

31.18.9 UBX-NAV-HPPOSLLH (0x01 0x14)

31.18.9.1 High Precision Geodetic Position Solution

Message	NAV-HPPOSLLH					
Description	High Precision Geodetic Position Solution					
Firmware	Supported on: <ul style="list-style-type: none"> u-blox 8 / u-blox M8 from protocol version 20.01 up to version 23.01 					
Type	Periodic/Polled					
Comment	<p>See important comments concerning validity of position given in section Navigation Output Filters.</p> <p>This message outputs the Geodetic position with high precision in the currently selected ellipsoid. The default is the WGS84 Ellipsoid, but can be changed with the message CFG-DAT.</p>					
Message Structure	Header	Class	ID	Length (Bytes)	Payload	Checksum
	0xB5 0x62	0x01	0x14	36	see below	CK_A CK_B
Payload Contents:						
Byte Offset	Number Format	Scaling	Name	Unit	Description	
0	U1	-	version	-	Message version (0 for this version)	
1	U1[3]	-	reserved1	-	Reserved	
4	U4	-	iTOW	ms	GPS time of week of the navigation epoch . See the description of iTOW for details.	
8	I4	1e-7	lon	deg	Longitude	
12	I4	1e-7	lat	deg	Latitude	
16	I4	-	height	mm	Height above ellipsoid.	
20	I4	-	hMSL	mm	Height above mean sea level	
24	I1	1e-9	lonHp	deg	High precision component of longitude. Must be in the range -99..+99. Precise longitude in $\text{deg} * 1e-7 = \text{lon} + (\text{lonHp} * 1e-2)$.	
25	I1	1e-9	latHp	deg	High precision component of latitude. Must be in the range -99..+99. Precise latitude in $\text{deg} * 1e-7 = \text{lat} + (\text{latHp} * 1e-2)$.	
26	I1	0.1	heightHp	mm	High precision component of height above ellipsoid. Must be in the range -9..+9. Precise height in mm = $\text{height} + (\text{heightHp} * 0.1)$.	
27	I1	0.1	hMSLHp	mm	High precision component of height above mean sea level. Must be in range -9..+9. Precise height in mm = $\text{hMSL} + (\text{hMSLHp} * 0.1)$	
28	U4	0.1	hAcc	mm	Horizontal accuracy estimate	
32	U4	0.1	vAcc	mm	Vertical accuracy estimate	

31.18.10 UBX-NAV-ODO (0x01 0x09)

31.18.10.1 Odometer Solution

Message	NAV-ODO					
Description	Odometer Solution					
Firmware	Supported on: <ul style="list-style-type: none"> u-blox 8 / u-blox M8 from protocol version 15 up to version 23.01 					
Type	Periodic/Polled					
Comment	This message outputs the traveled distance since last reset (see NAV-RESETODO) together with an associated estimated accuracy and the total cumulated ground distance (can only be reset by a cold start of the receiver).					
Message Structure	Header	Class	ID	Length (Bytes)	Payload	Checksum
	0xB5 0x62	0x01	0x09	20	see below	CK_A CK_B
Payload Contents:						
Byte Offset	Number Format	Scaling	Name	Unit	Description	
0	U1	-	version	-	Message version (0 for this version)	
1	U1[3]	-	reserved1	-	Reserved	
4	U4	-	iTOW	ms	GPS time of week of the navigation epoch . See the description of iTOW for details.	
8	U4	-	distance	m	Ground distance since last reset	
12	U4	-	totalDistance	m	Total cumulative ground distance	
16	U4	-	distanceStd	m	Ground distance accuracy (1-sigma)	

31.18.11 UBX-NAV-ORB (0x01 0x34)

31.18.11.1 GNSS Orbit Database Info

Message	NAV-ORB					
Description	GNSS Orbit Database Info					
Firmware	Supported on: <ul style="list-style-type: none"> u-blox 8 / u-blox M8 from protocol version 15 up to version 23.01 					
Type	Periodic/Polled					
Comment	Status of the GNSS orbit database knowledge.					
Message Structure	Header	Class	ID	Length (Bytes)	Payload	Checksum
	0xB5 0x62	0x01	0x34	8 + 6*numSv	see below	CK_A CK_B
Payload Contents:						
Byte Offset	Number Format	Scaling	Name	Unit	Description	
0	U4	-	iTOW	ms	GPS time of week of the navigation epoch . See the description of iTOW for details.	
4	U1	-	version	-	Message version (1, for this version)	
5	U1	-	numSv	-	Number of SVs in the database	
6	U1[2]	-	reserved1	-	Reserved	
Start of repeated block (numSv times)						
8 + 6*N	U1	-	gnssId	-	GNSS ID	
9 + 6*N	U1	-	svId	-	Satellite ID	
10 + 6*N	X1	-	svFlag	-	Information Flags (see graphic below)	

NAV-ORB continued

Byte Offset	Number Format	Scaling	Name	Unit	Description
11 + 6*N	X1	-	eph	-	Ephemeris data (see graphic below)
12 + 6*N	X1	-	alm	-	Almanac data (see graphic below)
13 + 6*N	X1	-	otherOrb	-	Other orbit data available (see graphic below)
End of repeated block					

Bitfield svFlag

This graphic explains the bits of svFlag

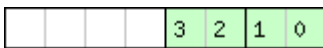

visibility

health

- signed value
- unsigned value
- reserved

Name	Description
health	SV health: 0: unknown 1: healthy 2: not healthy
visibility	SV health: 0: unknown 1: below horizon 2: above horizon 3: above elevation mask

Bitfield eph

This graphic explains the bits of eph

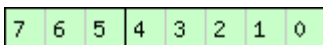

ephSource

ephUsability

- signed value
- unsigned value
- reserved

Name	Description
ephUsability	How long the receiver will be able to use the stored ephemeris data from now on: 31: The usability period is unknown 30: The usability period is more than 450 minutes 30 > n > 0: The usability period is between (n-1)*15 and n*15 minutes 0: Ephemeris can no longer be used

Bitfield eph Description continued

Name	Description
ephSource	0: not available 1: GNSS transmission 2: external aiding 3-7: other

Bitfield alm

This graphic explains the bits of alm

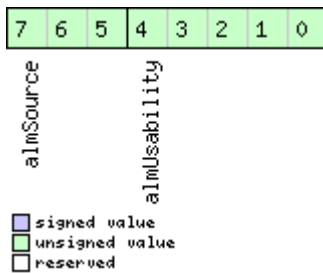

Name	Description
almUsability	How long the receiver will be able to use the stored almanac data from now on: 31: The usability period is unknown 30: The usability period is more than 30 days 30 > n > 0: The usability period is between n-1 and n days 0: Almanac can no longer be used
almSource	0: not available 1: GNSS transmission 2: external aiding 3-7: other

Bitfield otherOrb

This graphic explains the bits of otherOrb

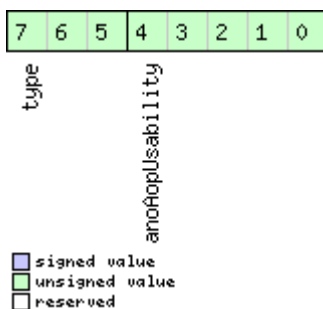

Name	Description
anoAopUsability	How long the receiver will be able to use the orbit data from now on: 31: The usability period is unknown 30: The usability period is more than 30 days 30 > n > 0: The usability period is between n-1 and n days 0: Data can no longer be used

Bitfield otherOrb Description continued

Name	Description
type	Type of orbit data: 0: No orbit data available 1: Assist now offline data 2: Assist now autonomous data 3-7: Other orbit data

31.18.12 UBX-NAV-POSECEF (0x01 0x01)

31.18.12.1 Position Solution in ECEF

Message	NAV-POSECEF					
Description	Position Solution in ECEF					
Firmware	Supported on: <ul style="list-style-type: none"> u-blox 8 / u-blox M8 from protocol version 15 up to version 23.01 					
Type	Periodic/Polled					
Comment	See important comments concerning validity of position given in section Navigation Output Filters. -					
Message Structure	Header	Class	ID	Length (Bytes)	Payload	Checksum
	0xB5 0x62	0x01	0x01	20	see below	CK_A CK_B
Payload Contents:						
Byte Offset	Number Format	Scaling	Name	Unit	Description	
0	U4	-	iTOW	ms	GPS time of week of the navigation epoch . See the description of iTOW for details.	
4	I4	-	ecefX	cm	ECEF X coordinate	
8	I4	-	ecefY	cm	ECEF Y coordinate	
12	I4	-	ecefZ	cm	ECEF Z coordinate	
16	U4	-	pAcc	cm	Position Accuracy Estimate	

31.18.13 UBX-NAV-POSL LH (0x01 0x02)

31.18.13.1 Geodetic Position Solution

Message	NAV-POSL LH					
Description	Geodetic Position Solution					
Firmware	Supported on: <ul style="list-style-type: none"> u-blox 8 / u-blox M8 from protocol version 15 up to version 23.01 					
Type	Periodic/Polled					
Comment	See important comments concerning validity of position given in section Navigation Output Filters. This message outputs the Geodetic position in the currently selected ellipsoid. The default is the WGS84 Ellipsoid, but can be changed with the message CFG-DAT .					
Message Structure	Header	Class	ID	Length (Bytes)	Payload	Checksum
	0xB5 0x62	0x01	0x02	28	see below	CK_A CK_B
Payload Contents:						

NAV-POSLLH continued

Byte Offset	Number Format	Scaling	Name	Unit	Description
0	U4	-	iTOW	ms	GPS time of week of the navigation epoch . See the description of iTOW for details.
4	I4	1e-7	lon	deg	Longitude
8	I4	1e-7	lat	deg	Latitude
12	I4	-	height	mm	Height above ellipsoid
16	I4	-	hMSL	mm	Height above mean sea level
20	U4	-	hAcc	mm	Horizontal accuracy estimate
24	U4	-	vAcc	mm	Vertical accuracy estimate

31.18.14 UBX-NAV-PVT (0x01 0x07)

31.18.14.1 Navigation Position Velocity Time Solution

Message	NAV-PVT					
Description	Navigation Position Velocity Time Solution					
Firmware	Supported on: <ul style="list-style-type: none"> • u-blox 8 / u-blox M8 from protocol version 15 up to version 23.01 					
Type	Periodic/Polled					
Comment	<p>Note that during a leap second there may be more (or less) than 60 seconds in a minute; see the description of leap seconds for details.</p> <p>This message combines position, velocity and time solution, including accuracy figures</p>					
Message Structure	Header	Class	ID	Length (Bytes)	Payload	Checksum
	0xB5 0x62	0x01	0x07	92	see below	CK_A CK_B
Payload Contents:						
Byte Offset	Number Format	Scaling	Name	Unit	Description	
0	U4	-	iTOW	ms	GPS time of week of the navigation epoch . See the description of iTOW for details.	
4	U2	-	year	y	Year (UTC)	
6	U1	-	month	month	Month, range 1..12 (UTC)	
7	U1	-	day	d	Day of month, range 1..31 (UTC)	
8	U1	-	hour	h	Hour of day, range 0..23 (UTC)	
9	U1	-	min	min	Minute of hour, range 0..59 (UTC)	
10	U1	-	sec	s	Seconds of minute, range 0..60 (UTC)	
11	X1	-	valid	-	Validity flags (see graphic below)	
12	U4	-	tAcc	ns	Time accuracy estimate (UTC)	
16	I4	-	nano	ns	Fraction of second, range -1e9 .. 1e9 (UTC)	

NAV-PVT continued

Byte Offset	Number Format	Scaling	Name	Unit	Description
20	U1	-	fixType	-	GNSSfix Type: 0: no fix 1: dead reckoning only 2: 2D-fix 3: 3D-fix 4: GNSS + dead reckoning combined 5: time only fix
21	X1	-	flags	-	Fix status flags (see graphic below)
22	X1	-	flags2	-	Additional flags (see graphic below)
23	U1	-	numSV	-	Number of satellites used in Nav Solution
24	I4	1e-7	lon	deg	Longitude
28	I4	1e-7	lat	deg	Latitude
32	I4	-	height	mm	Height above ellipsoid
36	I4	-	hMSL	mm	Height above mean sea level
40	U4	-	hAcc	mm	Horizontal accuracy estimate
44	U4	-	vAcc	mm	Vertical accuracy estimate
48	I4	-	velN	mm/s	NED north velocity
52	I4	-	velE	mm/s	NED east velocity
56	I4	-	velD	mm/s	NED down velocity
60	I4	-	gSpeed	mm/s	Ground Speed (2-D)
64	I4	1e-5	headMot	deg	Heading of motion (2-D)
68	U4	-	sAcc	mm/s	Speed accuracy estimate
72	U4	1e-5	headAcc	deg	Heading accuracy estimate (both motion and vehicle)
76	U2	0.01	pDOP	-	Position DOP
78	U1[6]	-	reserved1	-	Reserved
84	I4	1e-5	headVeh	deg	Heading of vehicle (2-D)
88	I2	1e-2	magDec	deg	Magnetic declination
90	U2	1e-2	magAcc	deg	Magnetic declination accuracy

Bitfield valid

This graphic explains the bits of valid

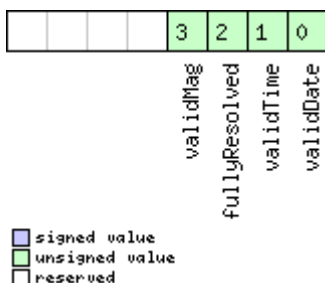

Name	Description
validDate	1 = valid UTC Date (see Time Validity section for details)
validTime	1 = valid UTC Time of Day (see Time Validity section for details)
fullyResolved	1 = UTC Time of Day has been fully resolved (no seconds uncertainty)

Bitfield valid Description continued

Name	Description
validMag	1 = valid Magnetic declination

Bitfield flags

This graphic explains the bits of flags

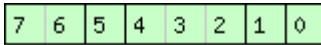

carrSoln
 headVehValid
 psmState
 diffSoln
 gnssFixOK

signed value
 unsigned value
 reserved

Name	Description
gnssFixOK	1 = valid fix (i.e within DOP & accuracy masks)
diffSoln	1 = differential corrections were applied
psmState	Power Save Mode state (see Power Management): 0: PSM is not active 1: Enabled (an intermediate state before Acquisition state) 2: Acquisition 3: Tracking 4: Power Optimized Tracking 5: Inactive
headVehValid	1 = heading of vehicle is valid
carrSoln	Carrier phase range solution status: 0: no carrier phase range solution 1: float solution (no fixed integer carrier phase measurements have been used to calculate the solution) 2: fixed solution (one or more fixed integer carrier phase range measurements have been used to calculate the solution) (not supported in protocol versions less than 20)

Bitfield flags2

This graphic explains the bits of flags2

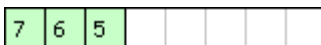

confirmedTime
 confirmedDate
 confirmedAvai

signed value
 unsigned value
 reserved

Name	Description
confirmedAvai	1 = information about UTC Date and Time of Day validity confirmation is available (see Time Validity section for details). This flag is only supported in Protocol Versions 19.00, 19.10, 20.10, 20.20, 20.30, 22.00, 23.00 and 23.01 .
confirmedDate	1 = UTC Date validity could be confirmed (see Time Validity section for details)

Bitfield flags2 Description continued

Name	Description
confirmedTime	1 = UTC Time of Day could be confirmed (see Time Validity section for details)

31.18.15 UBX-NAV-RELPOSNED (0x01 0x3C)
31.18.15.1 Relative Positioning Information in NED frame

Message	NAV-RELPOSNED					
Description	Relative Positioning Information in NED frame					
Firmware	Supported on: <ul style="list-style-type: none"> • u-blox 8 / u-blox M8 from protocol version 20 up to version 23.01 (only with High Precision GNSS products) 					
Type	Periodic/Polled					
Comment	<p>The NED frame is defined as the local topological system at the reference station. The relative position vector components in this message, along with their associated accuracies, are given in that local topological system</p> <p>This message contains the relative position vector from the Reference Station to the Rover, including accuracy figures, in the local topological system defined at the reference station</p>					
Message Structure	Header	Class	ID	Length (Bytes)	Payload	Checksum
	0xB5 0x62	0x01	0x3C	40	see below	CK_A CK_B
Payload Contents:						
Byte Offset	Number Format	Scaling	Name	Unit	Description	
0	U1	-	version	-	Message version (0x00 for this version)	
1	U1	-	reserved1	-	Reserved	
2	U2	-	refStationId	-	Reference Station ID. Must be in the range 0..4095	
4	U4	-	iTOW	ms	GPS time of week of the navigation epoch . See the description of iTOW for details.	
8	I4	-	relPosN	cm	North component of relative position vector	
12	I4	-	relPosE	cm	East component of relative position vector	
16	I4	-	relPosD	cm	Down component of relative position vector	
20	I1	0.1	relPosHPN	mm	High-precision North component of relative position vector. Must be in the range -99 to +99. The full North component of the relative position vector, in units of cm, is given by $relPosN + (relPosHPN * 1e-2)$	
21	I1	0.1	relPosHPE	mm	High-precision East component of relative position vector. Must be in the range -99 to +99. The full East component of the relative position vector, in units of cm, is given by $relPosE + (relPosHPE * 1e-2)$	

NAV-RELPOSNEED continued

Byte Offset	Number Format	Scaling	Name	Unit	Description
22	I1	0.1	relPosHPD	mm	High-precision Down component of relative position vector. Must be in the range -99 to +99. The full Down component of the relative position vector, in units of cm, is given by $relPosD + (relPosHPD * 1e-2)$
23	U1	-	reserved2	-	Reserved
24	U4	0.1	accN	mm	Accuracy of relative position North component
28	U4	0.1	accE	mm	Accuracy of relative position East component
32	U4	0.1	accD	mm	Accuracy of relative position Down component
36	X4	-	flags	-	Flags (see graphic below)

Bitfield flags

This graphic explains the bits of flags

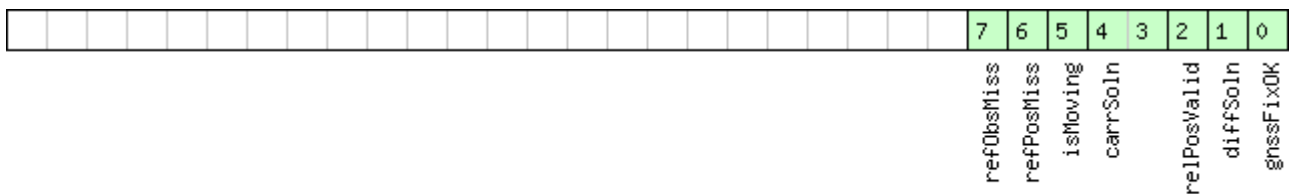

- signed value
- unsigned value
- reserved

Name	Description
gnssFixOK	A valid fix (i.e within DOP & accuracy masks)
diffSoln	1 if differential corrections were applied
relPosValid	1 if relative position components and accuracies are valid
carrSoln	Carrier phase range solution status: 0 = No carrier phase range solution 1 = Float solution. No fixed integer carrier phase measurements have been used to calculate the solution 2 = Fixed solution. One or more fixed integer carrier phase range measurements have been used to calculate the solution
isMoving	1 if the receiver is operating in moving baseline mode (not supported in protocol versions less than 20.3)
refPosMiss	1 if extrapolated reference position was used to compute moving baseline solution this epoch (not supported in protocol versions less than 20.3)
refObsMiss	1 if extrapolated reference observations were used to compute moving baseline solution this epoch (not supported in protocol versions less than 20.3)

31.18.16 UBX-NAV-RESETO (0x01 0x10)

31.18.16.1 Reset odometer

Message	NAV-RESETO					
Description	Reset odometer					
Firmware	Supported on: <ul style="list-style-type: none"> u-blox 8 / u-blox M8 from protocol version 15 up to version 23.01 					
Type	Command					
Comment	This message resets the traveled distance computed by the odometer (see UBX-NAV-ODO). UBX-ACK-ACK or UBX-ACK-NAK are returned to indicate success or failure.					
Message Structure	Header	Class	ID	Length (Bytes)	Payload	Checksum
	0xB5 0x62	0x01	0x10	0	see below	CK_A CK_B
No payload						

31.18.17 UBX-NAV-SAT (0x01 0x35)

31.18.17.1 Satellite Information

Message	NAV-SAT					
Description	Satellite Information					
Firmware	Supported on: <ul style="list-style-type: none"> u-blox 8 / u-blox M8 from protocol version 15 up to version 23.01 					
Type	Periodic/Polled					
Comment	This message displays information about SVs which are either known to be visible or currently tracked by the receiver.					
Message Structure	Header	Class	ID	Length (Bytes)	Payload	Checksum
	0xB5 0x62	0x01	0x35	8 + 12*numSvs	see below	CK_A CK_B
Payload Contents:						
Byte Offset	Number Format	Scaling	Name	Unit	Description	
0	U4	-	iTOW	ms	GPS time of week of the navigation epoch . See the description of iTOW for details.	
4	U1	-	version	-	Message version (1 for this version)	
5	U1	-	numSvs	-	Number of satellites	
6	U1[2]	-	reserved1	-	Reserved	
Start of repeated block (numSvs times)						
8 + 12*N	U1	-	gnssId	-	GNSS identifier (see Satellite numbering) for assignment	
9 + 12*N	U1	-	svId	-	Satellite identifier (see Satellite numbering) for assignment	
10 + 12*N	U1	-	cno	dBHz	Carrier to noise ratio (signal strength)	
11 + 12*N	I1	-	elev	deg	Elevation (range: +/-90), unknown if out of range	
12 + 12*N	I2	-	azim	deg	Azimuth (range 0-360), unknown if elevation is out of range	
14 + 12*N	I2	0.1	prRes	m	Pseudo range residual	
16 + 12*N	X4	-	flags	-	Bitmask (see graphic below)	

NAV-SAT continued

Byte Offset	Number Format	Scaling	Name	Unit	Description
End of repeated block					

Bitfield flags

This graphic explains the bits of flags

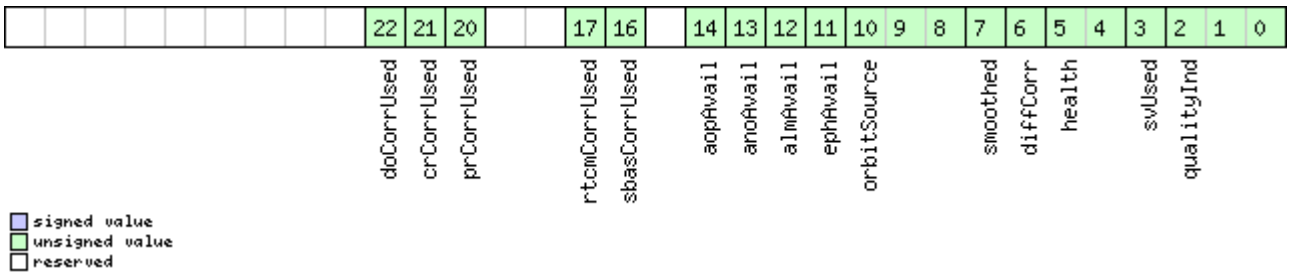

Name	Description
qualityInd	Signal quality indicator: 0: no signal 1: searching signal 2: signal aquired 3: signal detected but unusable 4: code locked and time synchronized 5, 6, 7: code and carrier locked and time synchronized Note: Since IMES signals are not time synchronized, a channel tracking an IMES signal can never reach a quality indicator value of higher than 3.
svUsed	1 = SV is currently being used for navigation
health	SV health flag: 0: unknown 1: healthy 2: unhealthy
diffCorr	1 = differential correction data is available for this SV
smoothed	1 = carrier smoothed pseudorange used
orbitSource	Orbit source: 0: no orbit information is available for this SV 1: ephemeris is used 2: almanac is used 3: AssistNow Offline orbit is used 4: AssistNow Autonomous orbit is used 5, 6, 7: other orbit information is used
ephAvail	1 = ephemeris is available for this SV
almAvail	1 = almanac is available for this SV
anoAvail	1 = AssistNow Offline data is available for this SV
aopAvail	1 = AssistNow Autonomous data is available for this SV
sbasCorrUsed	1 = SBAS corrections have been used for this SV
rtcmCorrUsed	1 = RTCM corrections have been used for this SV
prCorrUsed	1 = Pseudorange corrections have been used for this SV
crCorrUsed	1 = Carrier range corrections have been used for this SV

Bitfield flags Description continued

Name	Description
doCorrUsed	1 = Range rate (Doppler) corrections have been used for this SV

31.18.18 UBX-NAV-SBAS (0x01 0x32)
31.18.18.1 SBAS Status Data

Message	NAV-SBAS					
Description	SBAS Status Data					
Firmware	Supported on: <ul style="list-style-type: none"> u-blox 8 / u-blox M8 from protocol version 15 up to version 23.01 					
Type	Periodic/Polled					
Comment	This message outputs the status of the SBAS sub system					
Message Structure	Header	Class	ID	Length (Bytes)	Payload	Checksum
	0xB5 0x62	0x01	0x32	12 + 12*cnt	see below	CK_A CK_B
Payload Contents:						
Byte Offset	Number Format	Scaling	Name	Unit	Description	
0	U4	-	iTOW	ms	GPS time of week of the navigation epoch . See the description of iTOW for details.	
4	U1	-	geo	-	PRN Number of the GEO where correction and integrity data is used from	
5	U1	-	mode	-	SBAS Mode 0 Disabled 1 Enabled Integrity 3 Enabled Testmode	
6	I1	-	sys	-	SBAS System (WAAS/EGNOS/...) -1 Unknown 0 WAAS 1 EGNOS 2 MSAS 3 GAGAN 16 GPS	
7	X1	-	service	-	SBAS Services available (see graphic below)	
8	U1	-	cnt	-	Number of SV data following	
9	U1[3]	-	reserved1	-	Reserved	
Start of repeated block (cnt times)						
12 + 12*N	U1	-	svid	-	SV ID	
13 + 12*N	U1	-	flags	-	Flags for this SV	
14 + 12*N	U1	-	udre	-	Monitoring status	
15 + 12*N	U1	-	svSys	-	System (WAAS/EGNOS/...) same as SYS	
16 + 12*N	U1	-	svService	-	Services available same as SERVICE	
17 + 12*N	U1	-	reserved2	-	Reserved	
18 + 12*N	I2	-	prc	cm	Pseudo Range correction in [cm]	
20 + 12*N	U1[2]	-	reserved3	-	Reserved	

NAV-SBAS continued

Byte Offset	Number Format	Scaling	Name	Unit	Description
22 + 12*N	I2	-	ic	cm	Ionosphere correction in [cm]
End of repeated block					

Bitfield service

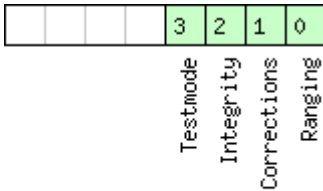
 This graphic explains the bits of `service`

- signed value
- unsigned value
- reserved

31.18.19 UBX-NAV-SOL (0x01 0x06)

31.18.19.1 Navigation Solution Information

Message	NAV-SOL					
Description	Navigation Solution Information					
Firmware	Supported on: <ul style="list-style-type: none"> • u-blox 8 / u-blox M8 from protocol version 15 up to version 23.01 					
Type	Periodic/Polled					
Comment	This message combines position, velocity and time solution in ECEF, including accuracy figures. This message has only been retained for backwards compatibility; users are recommended to use the UBX-NAV-PVT message in preference.					
Message Structure	Header	Class	ID	Length (Bytes)	Payload	Checksum
	0xB5 0x62	0x01	0x06	52	see below	CK_A CK_B
Payload Contents:						
Byte Offset	Number Format	Scaling	Name	Unit	Description	
0	U4	-	iTOW	ms	GPS time of week of the navigation epoch . See the description of iTOW for details.	
4	I4	-	fTOW	ns	Fractional part of iTOW (range: +/-500000). The precise GPS time of week in seconds is: (iTOW * 1e-3) + (fTOW * 1e-9)	
8	I2	-	week	weeks	GPS week number of the navigation epoch	

NAV-SOL continued

Byte Offset	Number Format	Scaling	Name	Unit	Description
10	U1	-	gpsFix	-	GPSfix Type, range 0..5 0x00 = No Fix 0x01 = Dead Reckoning only 0x02 = 2D-Fix 0x03 = 3D-Fix 0x04 = GPS + dead reckoning combined 0x05 = Time only fix 0x06..0xff: reserved
11	X1	-	flags	-	Fix Status Flags (see graphic below)
12	I4	-	ecefX	cm	ECEF X coordinate
16	I4	-	ecefY	cm	ECEF Y coordinate
20	I4	-	ecefZ	cm	ECEF Z coordinate
24	U4	-	pAcc	cm	3D Position Accuracy Estimate
28	I4	-	ecefVX	cm/s	ECEF X velocity
32	I4	-	ecefVY	cm/s	ECEF Y velocity
36	I4	-	ecefVZ	cm/s	ECEF Z velocity
40	U4	-	sAcc	cm/s	Speed Accuracy Estimate
44	U2	0.01	pDOP	-	Position DOP
46	U1	-	reserved1	-	Reserved
47	U1	-	numSV	-	Number of SVs used in Nav Solution
48	U1[4]	-	reserved2	-	Reserved

Bitfield flags

This graphic explains the bits of flags

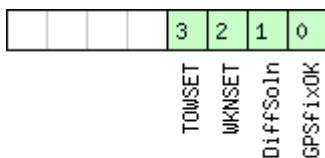

- signed value
- unsigned value
- reserved

Name	Description
GPSfixOK	1 = Fix within limits (e.g. DOP & accuracy)
DiffSoln	1 = DGPS used
WKNSSET	1 = Valid GPS week number (see Time Validity section for details)
TOWSET	1 = Valid GPS time of week (iTOW & fTOW, see Time Validity section for details)

31.18.20 UBX-NAV-STATUS (0x01 0x03)

31.18.20.1 Receiver Navigation Status

Message	NAV-STATUS					
Description	Receiver Navigation Status					
Firmware	Supported on: <ul style="list-style-type: none"> u-blox 8 / u-blox M8 from protocol version 15 up to version 23.01 					
Type	Periodic/Polled					
Comment	See important comments concerning validity of position and velocity given in section Navigation Output Filters. -					
Message Structure	Header	Class	ID	Length (Bytes)	Payload	Checksum
	0xB5 0x62	0x01	0x03	16	see below	CK_A CK_B
Payload Contents:						
Byte Offset	Number Format	Scaling	Name	Unit	Description	
0	U4	-	iTOW	ms	GPS time of week of the navigation epoch . See the description of iTOW for details.	
4	U1	-	gpsFix	-	GPSfix Type, this value does not qualify a fix as valid and within the limits. See note on flag gpsFixOk below. 0x00 = no fix 0x01 = dead reckoning only 0x02 = 2D-fix 0x03 = 3D-fix 0x04 = GPS + dead reckoning combined 0x05 = Time only fix 0x06..0xff = reserved	
5	X1	-	flags	-	Navigation Status Flags (see graphic below)	
6	X1	-	fixStat	-	Fix Status Information (see graphic below)	
7	X1	-	flags2	-	further information about navigation output (see graphic below)	
8	U4	-	ttff	ms	Time to first fix (millisecond time tag)	
12	U4	-	msss	ms	Milliseconds since Startup / Reset	

Bitfield flags

This graphic explains the bits of flags

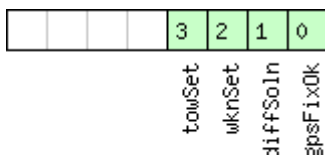

- signed value
- unsigned value
- reserved

Name	Description
gpsFixOk	1 = position and velocity valid and within DOP and ACC Masks, see also important comments in section Navigation Output Filters .

Bitfield flags Description continued

Name	Description
diffSoln	1 = differential corrections were applied
wknSet	1 = Week Number valid (see Time Validity section for details)
towSet	1 = Time of Week valid (see Time Validity section for details)

Bitfield fixStat

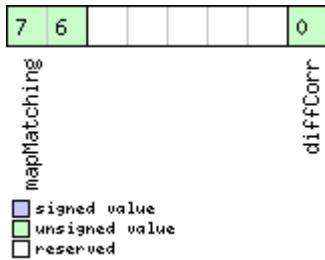
 This graphic explains the bits of `fixStat`

Name	Description
diffCorr	1 = differential corrections available
mapMatching	map matching status: 00: none 01: valid but not used, i.e. map matching data was received, but was too old 10: valid and used, map matching data was applied 11: valid and used, map matching data was applied. In case of sensor unavailability map matching data enables dead reckoning. This requires map matched latitude/longitude or heading data.

Bitfield flags2

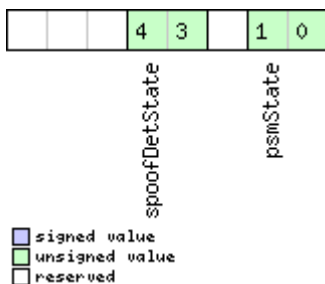
 This graphic explains the bits of `flags2`

Name	Description
psmState	power save mode state 0: ACQUISITION [or when psm disabled] 1: TRACKING 2: POWER OPTIMIZED TRACKING 3: INACTIVE

Bitfield flags2 Description continued

Name	Description
spooftDetState	Spoofing detection state (not supported in protocol versions less than 18) 0: Unknown or deactivated 1: No spoofing indicated 2: Spoofing indicated 3: Multiple spoofing indications Note that the spoofing state value only reflects the detector state for the current navigation epoch. As spoofing can be detected most easily at the transition from real signal to spoofing signal, this is also where the detector is triggered the most. I.e. a value of <i>1 - No spoofing indicated</i> does not mean that the receiver is not spoofed, it simply states that the detector was not triggered in this epoch.

31.18.21 UBX-NAV-SVINFO (0x01 0x30)
31.18.21.1 Space Vehicle Information

Message	NAV-SVINFO					
Description	Space Vehicle Information					
Firmware	Supported on: <ul style="list-style-type: none"> • u-blox 8 / u-blox M8 from protocol version 15 up to version 23.01 					
Type	Periodic/Polled					
Comment	Information about satellites used or visible This message has only been retained for backwards compatibility; users are recommended to use the UBX-NAV-SAT message in preference.					
Message Structure	Header	Class	ID	Length (Bytes)	Payload	Checksum
	0xB5 0x62	0x01	0x30	8 + 12*numCh	see below	CK_A CK_B
Payload Contents:						
Byte Offset	Number Format	Scaling	Name	Unit	Description	
0	U4	-	iTOW	ms	GPS time of week of the navigation epoch . See the description of iTOW for details.	
4	U1	-	numCh	-	Number of channels	
5	X1	-	globalFlags	-	Bitmask (see graphic below)	
6	U1[2]	-	reserved1	-	Reserved	
Start of repeated block (numCh times)						
8 + 12*N	U1	-	chn	-	Channel number, 255 for SVs not assigned to a channel	
9 + 12*N	U1	-	svid	-	Satellite ID, see Satellite numbering for assignment	
10 + 12*N	X1	-	flags	-	Bitmask (see graphic below)	
11 + 12*N	X1	-	quality	-	Bitfield (see graphic below)	
12 + 12*N	U1	-	cno	dBHz	Carrier to Noise Ratio (Signal Strength)	
13 + 12*N	I1	-	elev	deg	Elevation in integer degrees	
14 + 12*N	I2	-	azim	deg	Azimuth in integer degrees	
16 + 12*N	I4	-	prRes	cm	Pseudo range residual in centimeters	
End of repeated block						

Bitfield globalFlags

This graphic explains the bits of globalFlags



chipGen

- signed value
- unsigned value
- reserved

Name	Description
chipGen	Chip hardware generation 0: Antaris, Antaris 4 1: u-blox 5 2: u-blox 6 3: u-blox 7 4: u-blox 8 / u-blox M8

Bitfield flags

This graphic explains the bits of flags

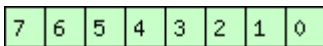

smoothed
orbitAop
orbitAlm
unhealthy
orbitEph
orbitAvail
diffCorr
svUsed

- signed value
- unsigned value
- reserved

Name	Description
svUsed	SV is used for navigation
diffCorr	Differential correction data is available for this SV
orbitAvail	Orbit information is available for this SV (Ephemeris or Almanac)
orbitEph	Orbit information is Ephemeris
unhealthy	SV is unhealthy / shall not be used
orbitAlm	Orbit information is Almanac Plus
orbitAop	Orbit information is AssistNow Autonomous
smoothed	Carrier smoothed pseudorange used

Bitfield quality

This graphic explains the bits of quality

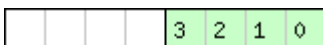

qualityInd

- signed value
- unsigned value
- reserved

Name	Description
------	-------------

Bitfield quality Description continued

Name	Description
qualityInd	Signal Quality indicator (range 0..7). The following list shows the meaning of the different QI values: 0: no signal 1: searching signal 2: signal aquired 3: signal detected but unusable 4: code locked and time synchronized 5, 6, 7: code and carrier locked and time synchronized Note: Since IMES signals are not time synchronized, a channel tracking an IMES signal can never reach a quality indicator value of higher than 3.

31.18.22 UBX-NAV-SVIN (0x01 0x3B)
31.18.22.1 Survey-in data

Message	NAV-SVIN					
Description	Survey-in data					
Firmware	Supported on: <ul style="list-style-type: none"> • u-blox 8 / u-blox M8 with protocol version 20 (only with High Precision GNSS products) 					
Type	Periodic/Polled					
Comment	This message contains information about survey-in parameters.					
Message Structure	Header	Class	ID	Length (Bytes)	Payload	Checksum
	0xB5 0x62	0x01	0x3B	40	see below	CK_A CK_B
Payload Contents:						
Byte Offset	Number Format	Scaling	Name	Unit	Description	
0	U1	-	version	-	Message version (0x00 for this version)	
1	U1[3]	-	reserved1	-	Reserved	
4	U4	-	iTOW	ms	GPS time of week of the navigation epoch . See the description of iTOW for details.	
8	U4	-	dur	s	Passed survey-in observation time	
12	I4	-	meanX	cm	Current survey-in mean position ECEF X coordinate	
16	I4	-	meanY	cm	Current survey-in mean position ECEF Y coordinate	
20	I4	-	meanZ	cm	Current survey-in mean position ECEF Z coordinate	
24	I1	-	meanXHP	0.1_mm	Current high-precision survey-in mean position ECEF X coordinate. Must be in the range -99..+99. The current survey-in mean position ECEF X coordinate, in units of cm, is given by $\text{meanX} + (0.01 * \text{meanXHP})$	

NAV-SVIN continued

Byte Offset	Number Format	Scaling	Name	Unit	Description
25	I1	-	meanYHP	0.1_mm	Current high-precision survey-in mean position ECEF Y coordinate. Must be in the range -99..+99. The current survey-in mean position ECEF Y coordinate, in units of cm, is given by $\text{meanY} + (0.01 * \text{meanYHP})$
26	I1	-	meanZHP	0.1_mm	Current high-precision survey-in mean position ECEF Z coordinate. Must be in the range -99..+99. The current survey-in mean position ECEF Z coordinate, in units of cm, is given by $\text{meanZ} + (0.01 * \text{meanZHP})$
27	U1	-	reserved2	-	Reserved
28	U4	-	meanAcc	0.1_mm	Current survey-in mean position accuracy
32	U4	-	obs	-	Number of position observations used during survey-in
36	U1	-	valid	-	Survey-in position validity flag, 1 = valid, otherwise 0
37	U1	-	active	-	Survey-in in progress flag, 1 = in-progress, otherwise 0
38	U1[2]	-	reserved3	-	Reserved

31.18.23 UBX-NAV-TIMEBDS (0x01 0x24)
31.18.23.1 BDS Time Solution

Message	NAV-TIMEBDS					
Description	BDS Time Solution					
Firmware	Supported on: <ul style="list-style-type: none"> • u-blox 8 / u-blox M8 from protocol version 17 up to version 23.01 					
Type	Periodic/Polled					
Comment	This message reports the precise BDS time of the most recent navigation solution including validity flags and an accuracy estimate.					
Message Structure	Header	Class	ID	Length (Bytes)	Payload	Checksum
	0xB5 0x62	0x01	0x24	20	<i>see below</i>	CK_A CK_B
Payload Contents:						
Byte Offset	Number Format	Scaling	Name	Unit	Description	
0	U4	-	iTOW	ms	GPS time of week of the navigation epoch . See the description of iTOW for details.	
4	U4	-	SOW	s	BDS time of week (rounded to seconds)	
8	I4	-	fSOW	ns	Fractional part of SOW (range: +/-500000000). The precise BDS time of week in seconds is: $\text{SOW} + \text{fSOW} * 1\text{e-}9$	

NAV-TIMEBDS continued

Byte Offset	Number Format	Scaling	Name	Unit	Description
12	I2	-	week	-	BDS week number of the navigation epoch
14	I1	-	leapS	s	BDS leap seconds (BDS-UTC)
15	X1	-	valid	-	Validity Flags (see graphic below)
16	U4	-	tAcc	ns	Time Accuracy Estimate

Bitfield valid

This graphic explains the bits of valid

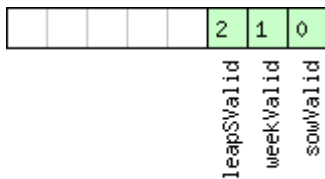

- signed value
- unsigned value
- reserved

Name	Description
sowValid	1 = Valid SOW and fSOW (see Time Validity section for details)
weekValid	1 = Valid week (see Time Validity section for details)
leapSValid	1 = Valid leapS

31.18.24 UBX-NAV-TIMEGAL (0x01 0x25)

31.18.24.1 Galileo Time Solution

Message	NAV-TIMEGAL					
Description	Galileo Time Solution					
Firmware	Supported on: <ul style="list-style-type: none"> • u-blox 8 / u-blox M8 from protocol version 18 up to version 23.01 					
Type	Periodic/Polled					
Comment	This message reports the precise Galileo time of the most recent navigation solution including validity flags and an accuracy estimate.					
Message Structure	Header	Class	ID	Length (Bytes)	Payload	Checksum
	0xB5 0x62	0x01	0x25	20	see below	CK_A CK_B
Payload Contents:						
Byte Offset	Number Format	Scaling	Name	Unit	Description	
0	U4	-	iTOW	ms	GPS time of week of the navigation epoch . See the description of iTOW for details.	
4	U4	-	galTow	s	Galileo time of week (rounded to seconds)	
8	I4	-	fGalTow	ns	Fractional part of SOW (range: +/-500000000). The precise Galileo time of week in seconds is: $galTow + fGalTow * 1e-9$	
12	I2	-	galWno	-	Galileo week number	
14	I1	-	leapS	s	Galileo leap seconds (Galileo-UTC)	
15	X1	-	valid	-	Validity Flags (see graphic below)	
16	U4	-	tAcc	ns	Time Accuracy Estimate	

Bitfield valid

This graphic explains the bits of `valid`

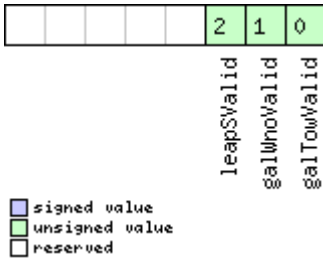

Name	Description
<code>galTowValid</code>	1 = Valid <code>galTow</code> and <code>fGalTow</code> (see Time Validity section for details)
<code>galWnoValid</code>	1 = Valid <code>galWno</code> (see Time Validity section for details)
<code>leapSValid</code>	1 = Valid <code>leapS</code>

31.18.25 UBX-NAV-TIMEGLO (0x01 0x23)

31.18.25.1 GLO Time Solution

Message	NAV-TIMEGLO					
Description	GLO Time Solution					
Firmware	Supported on: <ul style="list-style-type: none"> u-blox 8 / u-blox M8 from protocol version 17 up to version 23.01 					
Type	Periodic/Polled					
Comment	This message reports the precise GLO time of the most recent navigation solution including validity flags and an accuracy estimate.					
Message Structure	Header	Class	ID	Length (Bytes)	Payload	Checksum
	0xB5 0x62	0x01	0x23	20	see below	CK_A CK_B
Payload Contents:						
Byte Offset	Number Format	Scaling	Name	Unit	Description	
0	U4	-	<code>iTOW</code>	ms	GPS time of week of the navigation epoch . See the description of iTOW for details.	
4	U4	-	<code>TOD</code>	s	GLONASS time of day (rounded to integer seconds)	
8	I4	-	<code>fTOD</code>	ns	Fractional part of TOD (range: +/-500000000). The precise GLONASS time of day in seconds is: $TOD + fTOD * 1e-9$	
12	U2	-	<code>Nt</code>	days	Current date (range: 1-1461), starting at 1 from the 1st Jan of the year indicated by <code>N4</code> and ending at 1461 at the 31st Dec of the third year after that indicated by <code>N4</code>	
14	U1	-	<code>N4</code>	-	Four-year interval number starting from 1996 (1=1996, 2=2000, 3=2004...)	
15	X1	-	<code>valid</code>	-	Validity flags (see graphic below)	
16	U4	-	<code>tAcc</code>	ns	Time Accuracy Estimate	

Bitfield valid

This graphic explains the bits of valid

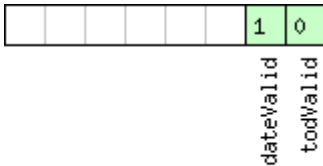

- signed value
- unsigned value
- reserved

Name	Description
todValid	1 = Valid TOD and fTOD (see Time Validity section for details)
dateValid	1 = Valid N4 and Nt (see Time Validity section for details)

31.18.26 UBX-NAV-TIMEGPS (0x01 0x20)

31.18.26.1 GPS Time Solution

Message	NAV-TIMEGPS					
Description	GPS Time Solution					
Firmware	Supported on: <ul style="list-style-type: none"> • u-blox 8 / u-blox M8 from protocol version 15 up to version 23.01 					
Type	Periodic/Polled					
Comment	This message reports the precise GPS time of the most recent navigation solution including validity flags and an accuracy estimate.					
Message Structure	Header	Class	ID	Length (Bytes)	Payload	Checksum
	0xB5 0x62	0x01	0x20	16	see below	CK_A CK_B
Payload Contents:						
Byte Offset	Number Format	Scaling	Name	Unit	Description	
0	U4	-	iTOW	ms	GPS time of week of the navigation epoch . See the description of iTOW for details.	
4	I4	-	fTOW	ns	Fractional part of iTOW (range: +/-500000). The precise GPS time of week in seconds is: $(iTOW * 1e-3) + (fTOW * 1e-9)$	
8	I2	-	week	-	GPS week number of the navigation epoch	
10	I1	-	leapS	s	GPS leap seconds (GPS-UTC)	
11	X1	-	valid	-	Validity Flags (see graphic below)	
12	U4	-	tAcc	ns	Time Accuracy Estimate	

Bitfield valid

This graphic explains the bits of valid

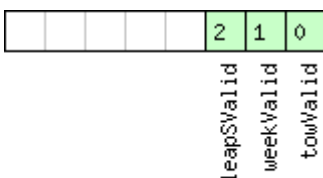

- signed value
- unsigned value
- reserved

Name	Description
------	-------------

Bitfield valid Description continued

Name	Description
towValid	1 = Valid GPS time of week (iTOW & fTOW, see Time Validity section for details)
weekValid	1 = Valid GPS week number (see Time Validity section for details)
leapSValid	1 = Valid GPS leap seconds

31.18.27 UBX-NAV-TIMELS (0x01 0x26)

31.18.27.1 Leap second event information

Message	NAV-TIMELS					
Description	Leap second event information					
Firmware	Supported on: <ul style="list-style-type: none"> u-blox 8 / u-blox M8 from protocol version 18 up to version 23.01 					
Type	Periodic/Polled					
Comment	Information about the upcoming leap second event if one is scheduled.					
Message Structure	Header	Class	ID	Length (Bytes)	Payload	Checksum
	0xB5 0x62	0x01	0x26	24	see below	CK_A CK_B
Payload Contents:						
Byte Offset	Number Format	Scaling	Name	Unit	Description	
0	U4	-	iTOW	ms	GPS time of week of the navigation epoch . See the description of iTOW for details.	
4	U1	-	version	-	Message version (0x00 for this version).	
5	U1[3]	-	reserved1	-	Reserved	
8	U1	-	srcOfCurrLs	-	Information source for the current number of leap seconds. 0: Default (hardcoded in the firmware, can be outdated) 1: Derived from time difference between GPS and GLONASS time 2: GPS 3: SBAS 4: BeiDou 5: Galileo 6: Aided data 7: Configured 255: Unknown	
9	I1	-	currLs	s	Current number of leap seconds since start of GPS time (Jan 6, 1980). It reflects how much GPS time is ahead of UTC time. Galileo number of leap seconds is the same as GPS. BeiDou number of leap seconds is 14 less than GPS. GLONASS follows UTC time, so no leap seconds.	

31.18.28 UBX-NAV-TIMEUTC (0x01 0x21)

31.18.28.1 UTC Time Solution

Message	NAV-TIMEUTC					
Description	UTC Time Solution					
Firmware	Supported on: <ul style="list-style-type: none"> u-blox 8 / u-blox M8 from protocol version 15 up to version 23.01 					
Type	Periodic/Polled					
Comment	Note that during a leap second there may be more or less than 60 seconds in a minute; see the description of leap seconds for details. -					
Message Structure	Header	Class	ID	Length (Bytes)	Payload	Checksum
	0xB5 0x62	0x01	0x21	20	see below	CK_A CK_B
Payload Contents:						
Byte Offset	Number Format	Scaling	Name	Unit	Description	
0	U4	-	iTOW	ms	GPS time of week of the navigation epoch . See the description of iTOW for details.	
4	U4	-	tAcc	ns	Time accuracy estimate (UTC)	
8	I4	-	nano	ns	Fraction of second, range -1e9 .. 1e9 (UTC)	
12	U2	-	year	y	Year, range 1999..2099 (UTC)	
14	U1	-	month	month	Month, range 1..12 (UTC)	
15	U1	-	day	d	Day of month, range 1..31 (UTC)	
16	U1	-	hour	h	Hour of day, range 0..23 (UTC)	
17	U1	-	min	min	Minute of hour, range 0..59 (UTC)	
18	U1	-	sec	s	Seconds of minute, range 0..60 (UTC)	
19	X1	-	valid	-	Validity Flags (see graphic below)	

Bitfield valid

This graphic explains the bits of `valid`

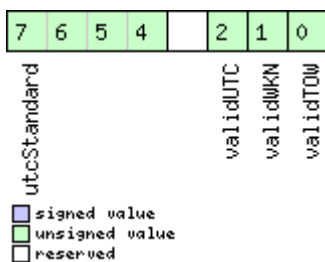

Name	Description
<code>validTOW</code>	1 = Valid Time of Week (see Time Validity section for details)
<code>validWKN</code>	1 = Valid Week Number (see Time Validity section for details)
<code>validUTC</code>	1 = Valid UTC Time

Bitfield valid Description continued

Name	Description
utcStandard	UTC standard identifier. 0: Information not available 1: Communications Research Laboratory (CRL) 2: National Institute of Standards and Technology (NIST) 3: U.S. Naval Observatory (USNO) 4: International Bureau of Weights and Measures (BIPM) 5: European Laboratory (tdb) 6: Former Soviet Union (SU) 7: National Time Service Center, China (NTSC) 15: Unknown

31.18.29 UBX-NAV-VELECEF (0x01 0x11)

31.18.29.1 Velocity Solution in ECEF

Message	NAV-VELECEF					
Description	Velocity Solution in ECEF					
Firmware	Supported on: <ul style="list-style-type: none"> u-blox 8 / u-blox M8 from protocol version 15 up to version 23.01 					
Type	Periodic/Polled					
Comment	See important comments concerning validity of velocity given in section Navigation Output Filters. -					
Message Structure	Header	Class	ID	Length (Bytes)	Payload	Checksum
	0xB5 0x62	0x01	0x11	20	see below	CK_A CK_B
Payload Contents:						
Byte Offset	Number Format	Scaling	Name	Unit	Description	
0	U4	-	iTOW	ms	GPS time of week of the navigation epoch . See the description of iTOW for details.	
4	I4	-	ecefVX	cm/s	ECEF X velocity	
8	I4	-	ecefVY	cm/s	ECEF Y velocity	
12	I4	-	ecefVZ	cm/s	ECEF Z velocity	
16	U4	-	sAcc	cm/s	Speed accuracy estimate	

31.18.30 UBX-NAV-VELNED (0x01 0x12)

31.18.30.1 Velocity Solution in NED

Message	NAV-VELNED					
Description	Velocity Solution in NED					
Firmware	Supported on: <ul style="list-style-type: none"> u-blox 8 / u-blox M8 from protocol version 15 up to version 23.01 					
Type	Periodic/Polled					
Comment	See important comments concerning validity of velocity given in section Navigation Output Filters. -					
Message Structure	Header	Class	ID	Length (Bytes)	Payload	Checksum
	0xB5 0x62	0x01	0x12	36	see below	CK_A CK_B
Payload Contents:						
Byte Offset	Number Format	Scaling	Name	Unit	Description	
0	U4	-	iTOW	ms	GPS time of week of the navigation epoch . See the description of iTOW for details.	
4	I4	-	velN	cm/s	North velocity component	
8	I4	-	velE	cm/s	East velocity component	
12	I4	-	velD	cm/s	Down velocity component	
16	U4	-	speed	cm/s	Speed (3-D)	
20	U4	-	gSpeed	cm/s	Ground speed (2-D)	
24	I4	1e-5	heading	deg	Heading of motion 2-D	
28	U4	-	sAcc	cm/s	Speed accuracy Estimate	
32	U4	1e-5	cAcc	deg	Course / Heading accuracy estimate	

31.19 UBX-RXM (0x02)

Receiver Manager Messages: i.e. Satellite Status, RTC Status.

Messages in the RXM class are used to output status and result data from the Receiver Manager. The output rate is not bound to the navigation/measurement rate and messages can also be generated on events.

31.19.1 UBX-RXM-IMES (0x02 0x61)

31.19.1.1 Indoor Messaging System Information

Message	RXM-IMES					
Description	Indoor Messaging System Information					
Firmware	Supported on: <ul style="list-style-type: none"> • u-blox 8 / u-blox M8 from protocol version 18 up to version 23.01 					
Type	Periodic/Polled					
Comment	<p>This message shows the IMES stations the receiver is currently tracking, their data rate, the signal level, the Doppler (with respect to 1575.4282MHz) and what data (without protocol specific overhead) it has received from these stations so far.</p> <p>This message is sent out at the navigation rate the receiver is currently set to. Therefore it allows users to get an overview on the receiver's current state from the IMES perspective.</p>					
Message Structure	Header	Class	ID	Length (Bytes)	Payload	Checksum
	0xB5 0x62	0x02	0x61	4 + 44*numTx	see below	CK_A CK_B
Payload Contents:						
Byte Offset	Number Format	Scaling	Name	Unit	Description	
0	U1	-	numTx	-	Number of transmitters contained in the message	
1	U1	-	version	-	Message version (0x01 for this version)	
2	U1[2]	-	reserved1	-	Reserved	
Start of repeated block (numTx times)						
4 + 44*N	U1	-	reserved2	-	Reserved	
5 + 44*N	U1	-	txId	-	Transmitter identifier	
6 + 44*N	U1[3]	-	reserved3	-	Reserved	
9 + 44*N	U1	-	cno	dBHz	Carrier to Noise Ratio (Signal Strength)	
10 + 44*N	U1[2]	-	reserved4	-	Reserved	
12 + 44*N	I4	2 ⁻¹²	doppler	Hz	Doppler frequency with respect to 1575.4282MHz [IIIII.FFF Hz]	
16 + 44*N	X4	-	position1_1	-	Position 1 Frame (part 1/2) (see graphic below)	
20 + 44*N	X4	-	position1_2	-	Position 1 Frame (part 2/2) (see graphic below)	
24 + 44*N	X4	-	position2_1	-	Position 2 Frame (part 1/3) (see graphic below)	
28 + 44*N	I4	{180*2 ⁻⁴ -24}	lat	deg	Latitude, Position 2 Frame (part 2/3)	
32 + 44*N	I4	{360*2 ⁻⁴ -25}	lon	deg	Longitude, Position 2 Frame (part 3/3)	
36 + 44*N	X4	-	shortIdFrame	-	Short ID Frame (see graphic below)	
40 + 44*N	U4	-	mediumIdLSB	-	Medium ID LSB, Medium ID Frame (part 1/2)	
44 + 44*N	X4	-	mediumId_2	-	Medium ID Frame (part 2/2) (see graphic below)	
End of repeated block						

Bitfield position1_1

This graphic explains the bits of `position1_1`

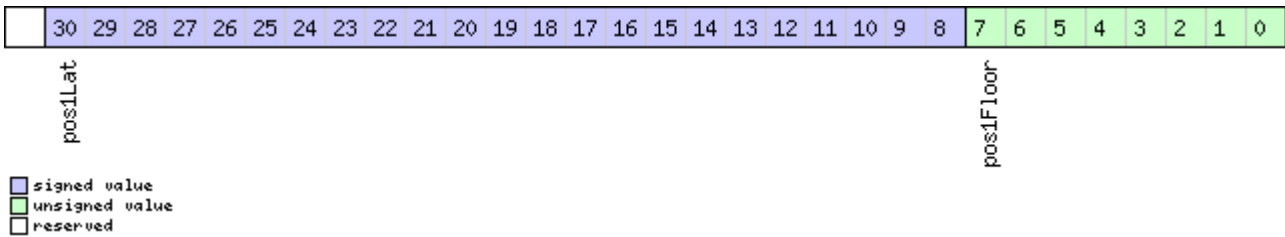

Name	Description
<code>pos1Floor</code>	Floor number [1.0 floor resolution] (Offset: -50 floor)
<code>pos1Lat</code>	Latitude [deg * (180 / 2 ²³)]

Bitfield position1_2

This graphic explains the bits of `position1_2`

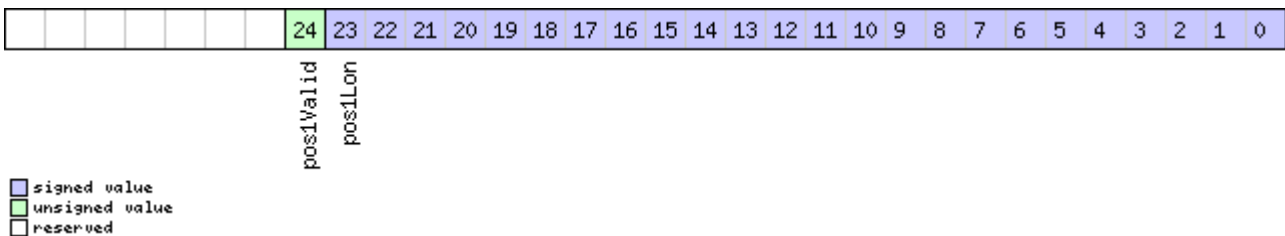

Name	Description
<code>pos1Lon</code>	Longitude [deg * (360 / 2 ²⁴)]
<code>pos1Valid</code>	Position 1 Frame valid

Bitfield position2_1

This graphic explains the bits of `position2_1`

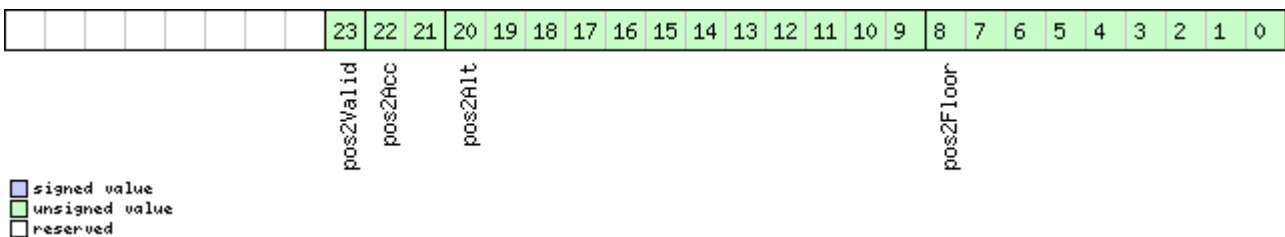

Name	Description
<code>pos2Floor</code>	Floor number [0.5 floor resolution] (Offset: -50 floor)
<code>pos2Alt</code>	Altitude [m] (Offset: -95m)
<code>pos2Acc</code>	Accuracy Index (0:undef, 1:<7m, 2:<15m, 3:>15m)
<code>pos2Valid</code>	Position 2 Frame valid

Bitfield shortIdFrame

This graphic explains the bits of shortIdFrame

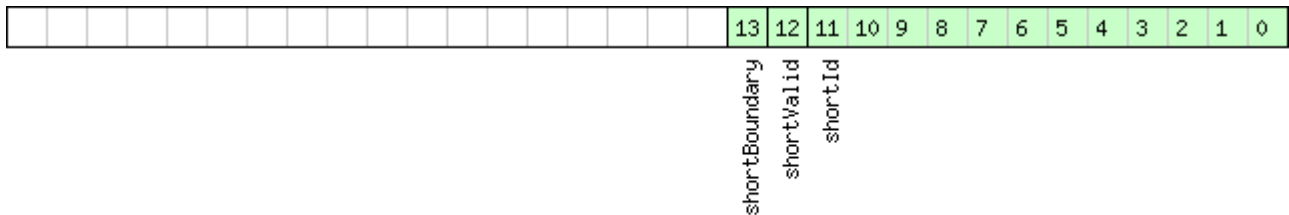

- signed value
- unsigned value
- reserved

Name	Description
shortId	Short ID
shortValid	Short ID Frame valid
shortBoundary	Boundary Bit

Bitfield mediumId_2

This graphic explains the bits of mediumId_2

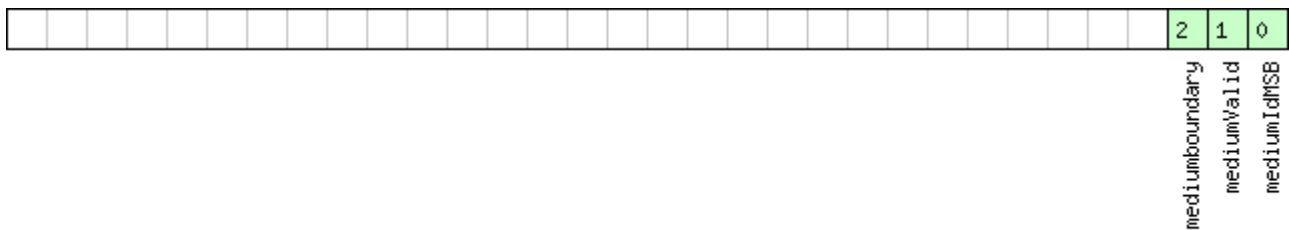

- signed value
- unsigned value
- reserved

Name	Description
mediumIdMSB	Medium ID MSB
mediumValid	Medium ID Frame valid
mediumboundary	Boundary Bit

31.19.2 UBX-RXM-MEASX (0x02 0x14)

31.19.2.1 Satellite Measurements for RRLP

Message	RXM-MEASX
Description	Satellite Measurements for RRLP
Firmware	Supported on: <ul style="list-style-type: none"> • u-blox 8 / u-blox M8 from protocol version 18 up to version 23.01
Type	Periodic
Comment	The message payload data is, where possible and appropriate, according to the Radio Resource LCS (Location Services) Protocol (RRLP) [1]. One exception is the satellite and GNSS ids, which here are given according to the Satellite Numbering scheme. The correct satellites have to be selected and their satellite ID translated accordingly [1, tab. A.10.14] for use in a RRLP Measure Position Response Component. Similarly, the measurement reference time of week has to be forwarded correctly (modulo 14400000 for the 24 LSB GPS measurements variant, modulo 3600000 for the 22 LSB Galileo and Additional Navigation Satellite Systems (GANSS) measurements variant) of the RRLP measure position

<p>response to the SMLC. Reference: [1] ETSI TS 144 031 V11.0.0 (2012-10), Digital cellular telecommunications system (Phase 2+), Location Services (LCS), Mobile Station (MS) - Serving Mobile Location Centre (SMLC), Radio Resource LCS Protocol (RRLP), (3GPP TS 44.031 version 11.0.0 Release 11).</p>						
Message Structure	Header	Class	ID	Length (Bytes)	Payload	Checksum
	0xB5 0x62	0x02	0x14	44 + 24*numSV	see below	CK_A CK_B
Payload Contents:						
Byte Offset	Number Format	Scaling	Name	Unit	Description	
0	U1	-	version	-	Message version, currently 0x00	
1	U1[3]	-	reserved1	-	Reserved	
4	U4	-	gpsTOW	ms	GPS measurement reference time	
8	U4	-	gloTOW	ms	GLONASS measurement reference time	
12	U4	-	bdsTOW	ms	BeiDou measurement reference time	
16	U1[4]	-	reserved2	-	Reserved	
20	U4	-	qzssTOW	ms	QZSS measurement reference time	
24	U2	2 ⁻⁴	gpsTOWacc	ms	GPS measurement reference time accuracy (0xffff = > 4s)	
26	U2	2 ⁻⁴	gloTOWacc	ms	GLONASS measurement reference time accuracy (0xffff = > 4s)	
28	U2	2 ⁻⁴	bdsTOWacc	ms	BeiDou measurement reference time accuracy (0xffff = > 4s)	
30	U1[2]	-	reserved3	-	Reserved	
32	U2	2 ⁻⁴	qzssTOWacc	ms	QZSS measurement reference time accuracy (0xffff = > 4s)	
34	U1	-	numSV	-	Number of satellites in repeated block	
35	U1	-	flags	-	Flags (see graphic below)	
36	U1[8]	-	reserved4	-	Reserved	
Start of repeated block (numSV times)						
44 + 24*N	U1	-	gnssId	-	GNSS ID (see Satellite Numbering)	
45 + 24*N	U1	-	svId	-	Satellite ID (see Satellite Numbering)	
46 + 24*N	U1	-	cNo	-	carrier noise ratio (0..63)	
47 + 24*N	U1	-	mpathIndic	-	multipath index (according to [1]) (0 = not measured, 1 = low, 2 = medium, 3 = high)	
48 + 24*N	I4	0.04	dopplerMS	m/s	Doppler measurement	
52 + 24*N	I4	0.2	dopplerHz	Hz	Doppler measurement	
56 + 24*N	U2	-	wholeChips	-	whole value of the code phase measurement (0..1022 for GPS)	
58 + 24*N	U2	-	fracChips	-	fractional value of the code phase measurement (0..1023)	
60 + 24*N	U4	2 ⁻²¹	codePhase	ms	Code phase	
64 + 24*N	U1	-	intCodePhase	ms	Integer (part of the) code phase	
65 + 24*N	U1	-	pseuRangeRMSErr	-	pseudorange RMS error index (according to [1]) (0..63)	
66 + 24*N	U1[2]	-	reserved5	-	Reserved	

RXM-MEASX continued

Byte Offset	Number Format	Scaling	Name	Unit	Description
End of repeated block					

Bitfield flags

This graphic explains the bits of flags



towSet

- signed value
- unsigned value
- reserved

Name	Description
towSet	TOW set (0 = no, 1 or 2 = yes)

31.19.3 UBX-RXM-PMREQ (0x02 0x41)

31.19.3.1 Requests a Power Management task

Message	RXM-PMREQ					
Description	Requests a Power Management task					
Firmware	Supported on: <ul style="list-style-type: none"> • u-blox 8 / u-blox M8 from protocol version 15 up to version 23.01 					
Type	Command					
Comment	Request of a Power Management related task of the receiver.					
Message Structure	Header	Class	ID	Length (Bytes)	Payload	Checksum
	0xB5 0x62	0x02	0x41	8	see below	CK_A CK_B
Payload Contents:						
Byte Offset	Number Format	Scaling	Name	Unit	Description	
0	U4	-	duration	ms	Duration of the requested task, set to zero for infinite duration. The maximum supported time is 12 days.	
4	X4	-	flags	-	task flags (see graphic below)	

Bitfield flags

This graphic explains the bits of flags

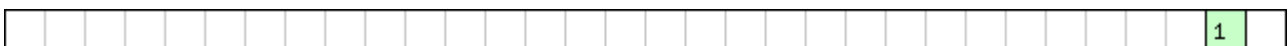

backup

- signed value
- unsigned value
- reserved

Name	Description
backup	The receiver goes into backup mode for a time period defined by duration. Provided that it is not connected to USB

31.19.3.2 Requests a Power Management task

Message	RXM-PMREQ					
Description	Requests a Power Management task					
Firmware	Supported on: <ul style="list-style-type: none"> • u-blox 8 / u-blox M8 from protocol version 18 up to version 23.01 					
Type	Command					
Comment	Request of a Power Management related task of the receiver.					
Message Structure	Header	Class	ID	Length (Bytes)	Payload	Checksum
	0xB5 0x62	0x02	0x41	16	see below	CK_A CK_B
Payload Contents:						
Byte Offset	Number Format	Scaling	Name	Unit	Description	
0	U1	-	version	-	Message version (0x00 for this version)	
1	U1[3]	-	reserved1	-	Reserved	
4	U4	-	duration	ms	Duration of the requested task, set to zero for infinite duration. The maximum supported time is 12 days.	
8	X4	-	flags	-	task flags (see graphic below)	
12	X4	-	wakeupSources	-	Configure pins to wakeup the receiver. The receiver wakes up if there is either a falling or a rising edge on one of the configured pins (see graphic below)	

Bitfield flags

This graphic explains the bits of flags

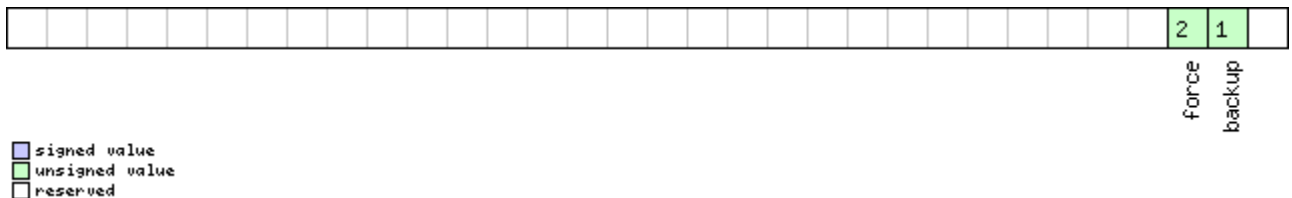

Name	Description
backup	The receiver goes into backup mode for a time period defined by duration. Provided that it is not connected to USB
force	Force receiver backup while USB is connected. USB interface will be disabled.

Bitfield wakeupSources

This graphic explains the bits of wakeupSources

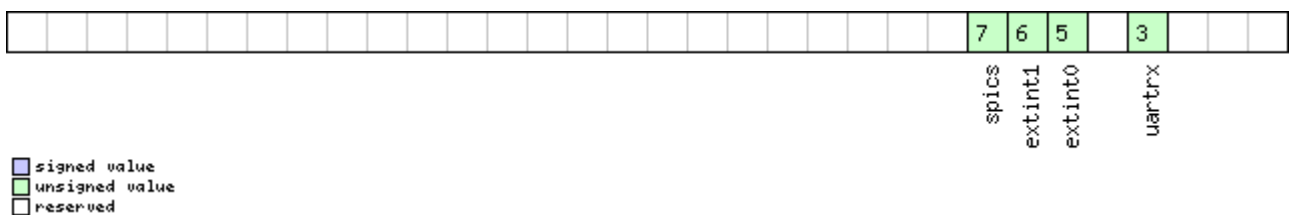

Name	Description
uartrx	Wakeup the receiver if there is an edge on the UART RX pin.

Bitfield wakeupSources Description continued

Name	Description
extint0	Wakeup the receiver if there is an edge on the EXTINT0 pin.
extint1	Wakeup the receiver if there is an edge on the EXTINT1 pin.
spics	Wakeup the receiver if there is an edge on the SPI CS pin.

31.19.4 UBX-RXM-RAWX (0x02 0x15)
31.19.4.1 Multi-GNSS Raw Measurement Data

Message	RXM-RAWX					
Description	Multi-GNSS Raw Measurement Data					
Firmware	Supported on: <ul style="list-style-type: none"> u-blox 8 / u-blox M8 with protocol version 17 (only with Time Sync products) 					
Type	Periodic/Polled					
Comment	This message contains the information needed to be able to generate a RINEX 3 multi-GNSS observation file. This message contains pseudorange, Doppler, carrier phase, phase lock and signal quality information for GNSS satellites once signals have been synchronized. This message supports all active GNSS.					
Message Structure	Header	Class	ID	Length (Bytes)	Payload	Checksum
	0xB5 0x62	0x02	0x15	16 + 32*numMeas	see below	CK_A CK_B
Payload Contents:						
Byte Offset	Number Format	Scaling	Name	Unit	Description	
0	R8	-	rcvTow	s	Measurement time of week in receiver local time approximately aligned to the GPS time system. The receiver local time of week, week number and leap second information can be used to translate the time to other time systems. More information about the difference in time systems can be found in RINEX 3 documentation. For a receiver operating in GLONASS only mode, UTC time can be determined by subtracting the leapS field from GPS time regardless of whether the GPS leap seconds are valid.	
8	U2	-	week	weeks	GPS week number in receiver local time .	
10	I1	-	leapS	s	GPS leap seconds (GPS-UTC). This field represents the receiver's best knowledge of the leap seconds offset. A flag is given in the recStat bitfield to indicate if the leap seconds are known.	
11	U1	-	numMeas	-	Number of measurements to follow	
12	X1	-	recStat	-	Receiver tracking status bitfield (see graphic below)	
13	U1[3]	-	reserved1	-	Reserved	
Start of repeated block (numMeas times)						

RXM-RAWX continued

Byte Offset	Number Format	Scaling	Name	Unit	Description
16 + 32*N	R8	-	prMes	m	Pseudorange measurement [m]. GLONASS inter frequency channel delays are compensated with an internal calibration table.
24 + 32*N	R8	-	cpMes	cycles	Carrier phase measurement [cycles]. The carrier phase initial ambiguity is initialized using an approximate value to make the magnitude of the phase close to the pseudorange measurement. Clock resets are applied to both phase and code measurements in accordance with the RINEX specification.
32 + 32*N	R4	-	doMes	Hz	Doppler measurement (positive sign for approaching satellites) [Hz]
36 + 32*N	U1	-	gnssId	-	GNSS identifier (see Satellite Numbering for a list of identifiers)
37 + 32*N	U1	-	svId	-	Satellite identifier (see Satellite Numbering)
38 + 32*N	U1	-	reserved2	-	Reserved
39 + 32*N	U1	-	freqId	-	Only used for GLONASS: This is the frequency slot + 7 (range from 0 to 13)
40 + 32*N	U2	-	locktime	ms	Carrier phase locktime counter (maximum 64500ms)
42 + 32*N	U1	-	cno	dBHz	Carrier-to-noise density ratio (signal strength) [dB-Hz]
43 + 32*N	X1	0.01*2 ⁿ	prStdev	m	Estimated pseudorange measurement standard deviation (see graphic below)
44 + 32*N	X1	0.004	cpStdev	cycles	Estimated carrier phase measurement standard deviation (note a raw value of 0x0F indicates the value is invalid) (see graphic below)
45 + 32*N	X1	0.002*2 ⁿ	doStdev	Hz	Estimated Doppler measurement standard deviation. (see graphic below)
46 + 32*N	X1	-	trkStat	-	Tracking status bitfield (see graphic below)
47 + 32*N	U1	-	reserved3	-	Reserved
<i>End of repeated block</i>					

Bitfield recStat

This graphic explains the bits of recStat

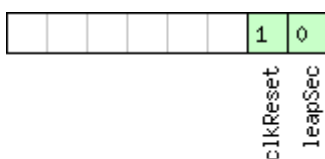

- signed value
- unsigned value
- reserved

Name	Description
------	-------------

Bitfield recStat Description continued

Name	Description
leapSec	Leap seconds have been determined
clkReset	Clock reset applied. Typically the receiver clock is changed in increments of integer milliseconds.

Bitfield prStdv

This graphic explains the bits of prStdv

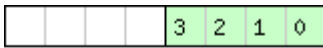

prStd

- signed value
- unsigned value
- reserved

Name	Description
prStd	Estimated pseudorange standard deviation

Bitfield cpStdv

This graphic explains the bits of cpStdv

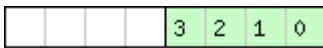

cpStd

- signed value
- unsigned value
- reserved

Name	Description
cpStd	Estimated carrier phase standard deviation

Bitfield doStdv

This graphic explains the bits of doStdv

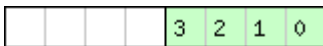

doStd

- signed value
- unsigned value
- reserved

Name	Description
doStd	Estimated Doppler standard deviation

Bitfield trkStat

This graphic explains the bits of trkStat

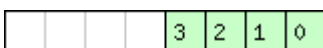

subHalfCyc
halfCyc
cpValid
prValid

- signed value
- unsigned value
- reserved

Name	Description
------	-------------

Bitfield trkStat Description continued

Name	Description
prValid	Pseudorange valid
cpValid	Carrier phase valid
halfCyc	Half cycle valid
subHalfCyc	Half cycle subtracted from phase

31.19.4.2 Multi-GNSS Raw Measurement Data

Message	RXM-RAWX					
Description	Multi-GNSS Raw Measurement Data					
Firmware	Supported on: <ul style="list-style-type: none"> u-blox 8 / u-blox M8 from protocol version 18 up to version 23.01 (only with Time Sync products) 					
Type	Periodic/Polled					
Comment	This message contains the information needed to be able to generate a RINEX 3 multi-GNSS observation file. This message contains pseudorange, Doppler, carrier phase, phase lock and signal quality information for GNSS satellites once signals have been synchronized. This message supports all active GNSS. The only difference between this version of the message and the previous version is the addition of the version field.					
Message Structure	Header	Class	ID	Length (Bytes)	Payload	Checksum
	0xB5 0x62	0x02	0x15	16 + 32*numMeas	see below	CK_A CK_B
Payload Contents:						
Byte Offset	Number Format	Scaling	Name	Unit	Description	
0	R8	-	rcvTow	s	Measurement time of week in receiver local time approximately aligned to the GPS time system. The receiver local time of week, week number and leap second information can be used to translate the time to other time systems. More information about the difference in time systems can be found in RINEX 3 documentation. For a receiver operating in GLONASS only mode, UTC time can be determined by subtracting the leapS field from GPS time regardless of whether the GPS leap seconds are valid.	
8	U2	-	week	weeks	GPS week number in receiver local time .	
10	I1	-	leapS	s	GPS leap seconds (GPS-UTC). This field represents the receiver's best knowledge of the leap seconds offset. A flag is given in the recStat bitfield to indicate if the leap seconds are known.	
11	U1	-	numMeas	-	Number of measurements to follow	

RXM-RAWX continued

Byte Offset	Number Format	Scaling	Name	Unit	Description
12	X1	-	recStat	-	Receiver tracking status bitfield (see graphic below)
13	U1	-	version	-	Message version (0x01 for this version).
14	U1[2]	-	reserved1	-	Reserved
<i>Start of repeated block (numMeas times)</i>					
16 + 32*N	R8	-	prMes	m	Pseudorange measurement [m]. GLONASS inter frequency channel delays are compensated with an internal calibration table.
24 + 32*N	R8	-	cpMes	cycles	Carrier phase measurement [cycles]. The carrier phase initial ambiguity is initialized using an approximate value to make the magnitude of the phase close to the pseudorange measurement. Clock resets are applied to both phase and code measurements in accordance with the RINEX specification.
32 + 32*N	R4	-	doMes	Hz	Doppler measurement (positive sign for approaching satellites) [Hz]
36 + 32*N	U1	-	gnssId	-	GNSS identifier (see Satellite Numbering for a list of identifiers)
37 + 32*N	U1	-	svId	-	Satellite identifier (see Satellite Numbering)
38 + 32*N	U1	-	reserved2	-	Reserved
39 + 32*N	U1	-	freqId	-	Only used for GLONASS: This is the frequency slot + 7 (range from 0 to 13)
40 + 32*N	U2	-	locktime	ms	Carrier phase locktime counter (maximum 64500ms)
42 + 32*N	U1	-	cno	dBHz	Carrier-to-noise density ratio (signal strength) [dB-Hz]
43 + 32*N	X1	0.01*2 ⁿ	prStdev	m	Estimated pseudorange measurement standard deviation (see graphic below)
44 + 32*N	X1	0.004	cpStdev	cycles	Estimated carrier phase measurement standard deviation (note a raw value of 0x0F indicates the value is invalid) (see graphic below)
45 + 32*N	X1	0.002*2 ⁿ	doStdev	Hz	Estimated Doppler measurement standard deviation. (see graphic below)
46 + 32*N	X1	-	trkStat	-	Tracking status bitfield (see graphic below)
47 + 32*N	U1	-	reserved3	-	Reserved
<i>End of repeated block</i>					

Bitfield recStat

This graphic explains the bits of `recStat`

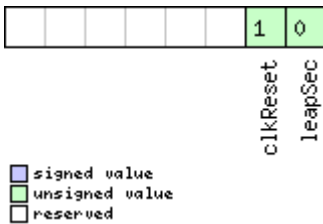

Name	Description
<code>leapSec</code>	Leap seconds have been determined
<code>clkReset</code>	Clock reset applied. Typically the receiver clock is changed in increments of integer milliseconds.

Bitfield prStdv

This graphic explains the bits of `prStdv`

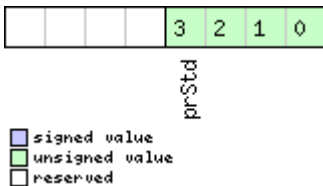

Name	Description
<code>prStd</code>	Estimated pseudorange standard deviation

Bitfield cpStdv

This graphic explains the bits of `cpStdv`

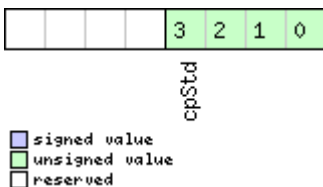

Name	Description
<code>cpStd</code>	Estimated carrier phase standard deviation

Bitfield doStdv

This graphic explains the bits of `doStdv`

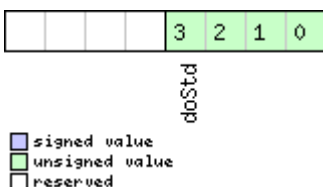

Name	Description
<code>doStd</code>	Estimated Doppler standard deviation

Bitfield trkStat

This graphic explains the bits of trkStat

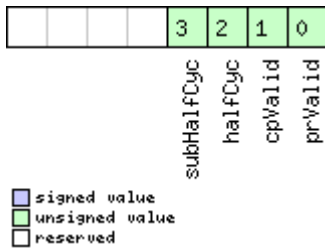

Name	Description
prValid	Pseudorange valid
cpValid	Carrier phase valid
halfCyc	Half cycle valid
subHalfCyc	Half cycle subtracted from phase

31.19.5 UBX-RXM-RLM (0x02 0x59)

31.19.5.1 Galileo SAR Short-RLM report

Message	RXM-RLM					
Description	Galileo SAR Short-RLM report					
Firmware	Supported on: <ul style="list-style-type: none"> u-blox 8 / u-blox M8 from protocol version 18 up to version 23.01 					
Type	Output					
Comment	This message contains the contents of any Galileo Search and Rescue (SAR) Short Return Link Message detected by the receiver.					
Message Structure	Header	Class	ID	Length (Bytes)	Payload	Checksum
	0xB5 0x62	0x02	0x59	16	see below	CK_A CK_B
Payload Contents:						
Byte Offset	Number Format	Scaling	Name	Unit	Description	
0	U1	-	version	-	Message version (0x00 for this version)	
1	U1	-	type	-	Message type (0x01 for Short-RLM)	
2	U1	-	svId	-	Identifier of transmitting satellite (see Satellite Numbering)	
3	U1	-	reserved1	-	Reserved	
4	U1[8]	-	beacon	-	Beacon identifier (60 bits), with bytes ordered by earliest transmitted (most significant) first. Top four bits of first byte are zero.	
12	U1	-	message	-	Message code (4 bits)	
13	U1[2]	-	params	-	Parameters (16 bits), with bytes ordered by earliest transmitted (most significant) first.	
15	U1	-	reserved2	-	Reserved	

31.19.5.2 Galileo SAR Long-RLM report

Message	RXM-RLM					
Description	Galileo SAR Long-RLM report					
Firmware	Supported on: <ul style="list-style-type: none"> • u-blox 8 / u-blox M8 from protocol version 18 up to version 23.01 					
Type	Output					
Comment	This message contains the contents of any Galileo Search and Rescue (SAR) Long Return Link Message detected by the receiver.					
Message Structure	Header	Class	ID	Length (Bytes)	Payload	Checksum
	0xB5 0x62	0x02	0x59	28	see below	CK_A CK_B
Payload Contents:						
Byte Offset	Number Format	Scaling	Name	Unit	Description	
0	U1	-	version	-	Message version (0x00 for this version)	
1	U1	-	type	-	Message type (0x02 for Long-RLM)	
2	U1	-	svId	-	Identifier of transmitting satellite (see Satellite Numbering)	
3	U1	-	reserved1	-	Reserved	
4	U1[8]	-	beacon	-	Beacon identifier (60 bits), with bytes ordered by earliest transmitted (most significant) first. Top four bits of first byte are zero.	
12	U1	-	message	-	Message code (4 bits)	
13	U1[12]	-	params	-	Parameters (96 bits), with bytes ordered by earliest transmitted (most significant) first.	
25	U1[3]	-	reserved2	-	Reserved	

31.19.6 UBX-RXM-RTCM (0x02 0x32)

31.19.6.1 RTCM input status

Message	RXM-RTCM					
Description	RTCM input status					
Firmware	Supported on: <ul style="list-style-type: none"> • u-blox 8 / u-blox M8 from protocol version 20.01 up to version 23.01 					
Type	Output					
Comment	Output upon processing of an RTCM input message					
Message Structure	Header	Class	ID	Length (Bytes)	Payload	Checksum
	0xB5 0x62	0x02	0x32	8	see below	CK_A CK_B
Payload Contents:						
Byte Offset	Number Format	Scaling	Name	Unit	Description	
0	U1	-	version	-	Message version (0x02 for this version)	
1	X1	-	flags	-	RTCM input status flags (see graphic below)	
2	U1[2]	-	reserved1	-	Reserved	
4	U2	-	refStation	-	Reference station ID	
6	U2	-	msgType	-	Message type	

Bitfield flags

This graphic explains the bits of flags

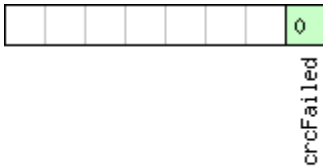

signed value
 unsigned value
 reserved

Name	Description
crcFailed	0 when RTCM message received and passed CRC check, 1 when failed in which case refStation and msgType might be corrupted and misleading

31.19.7 UBX-RXM-SFRBX (0x02 0x13)

31.19.7.1 Broadcast Navigation Data Subframe

Message	RXM-SFRBX					
Description	Broadcast Navigation Data Subframe					
Firmware	Supported on: <ul style="list-style-type: none"> u-blox 8 / u-blox M8 with protocol version 17 (only with Time Sync products) 					
Type	Output					
Comment	This message reports a complete subframe of broadcast navigation data decoded from a single signal. The number of data words reported in each message depends on the nature of the signal. See the section on Broadcast Navigation Data for further details.					
Message Structure	Header	Class	ID	Length (Bytes)	Payload	Checksum
	0xB5 0x62	0x02	0x13	8 + 4*numWords	see below	CK_A CK_B
Payload Contents:						
Byte Offset	Number Format	Scaling	Name	Unit	Description	
0	U1	-	gnssId	-	GNSS identifier (see Satellite Numbering)	
1	U1	-	svId	-	Satellite identifier (see Satellite Numbering)	
2	U1	-	reserved1	-	Reserved	
3	U1	-	freqId	-	Only used for GLONASS: This is the frequency slot + 7 (range from 0 to 13)	
4	U1	-	numWords	-	The number of data words contained in this message (0..16)	
5	U1	-	reserved2	-	Reserved	
6	U1	-	version	-	Message version (0x01 for this version)	
7	U1	-	reserved3	-	Reserved	
Start of repeated block (numWords times)						
8 + 4*N	U4	-	dwrđ	-	The data words	
End of repeated block						

31.19.7.2 Broadcast Navigation Data Subframe

Message		RXM-SFRBX					
Description		Broadcast Navigation Data Subframe					
Firmware		Supported on: <ul style="list-style-type: none"> • u-blox 8 / u-blox M8 from protocol version 18 up to version 23.01 					
Type		Output					
Comment		This message reports a complete subframe of broadcast navigation data decoded from a single signal. The number of data words reported in each message depends on the nature of the signal. See the section on Broadcast Navigation Data for further details.					
Message Structure		Header	Class	ID	Length (Bytes)	Payload	Checksum
		0xB5 0x62	0x02	0x13	8 + 4*numWords	see below	CK_A CK_B
Payload Contents:							
Byte Offset	Number Format	Scaling	Name	Unit	Description		
0	U1	-	gnssId	-	GNSS identifier (see Satellite Numbering)		
1	U1	-	svId	-	Satellite identifier (see Satellite Numbering)		
2	U1	-	reserved1	-	Reserved		
3	U1	-	freqId	-	Only used for GLONASS: This is the frequency slot + 7 (range from 0 to 13)		
4	U1	-	numWords	-	The number of data words contained in this message (up to 10, for currently supported signals)		
5	U1	-	chn	-	The tracking channel number the message was received on		
6	U1	-	version	-	Message version, (0x02 for this version)		
7	U1	-	reserved2	-	Reserved		
Start of repeated block (numWords times)							
8 + 4*N	U4	-	dwrđ	-	The data words		
End of repeated block							

31.19.8 UBX-RXM-SVSI (0x02 0x20)

31.19.8.1 SV Status Info

Message		RXM-SVSI					
Description		SV Status Info					
Firmware		Supported on: <ul style="list-style-type: none"> • u-blox 8 / u-blox M8 from protocol version 15 up to version 23.01 					
Type		Periodic/Polled					
Comment		Status of the receiver manager knowledge about GPS Orbit Validity This message has only been retained for backwards compatibility; users are recommended to use the UBX-NAV-ORB message in preference.					
Message Structure		Header	Class	ID	Length (Bytes)	Payload	Checksum
		0xB5 0x62	0x02	0x20	8 + 6*numSV	see below	CK_A CK_B
Payload Contents:							
Byte Offset	Number Format	Scaling	Name	Unit	Description		

RXM-SVSI continued

Byte Offset	Number Format	Scaling	Name	Unit	Description
0	U4	-	iTOW	ms	GPS time of week of the navigation epoch . See the description of iTOW for details.
4	I2	-	week	weeks	GPS week number of the navigation epoch
6	U1	-	numVis	-	Number of visible satellites
7	U1	-	numSV	-	Number of per-SV data blocks following
<i>Start of repeated block (numSV times)</i>					
8 + 6*N	U1	-	svid	-	Satellite ID
9 + 6*N	X1	-	svFlag	-	Information Flags (see graphic below)
10 + 6*N	I2	-	azim	-	Azimuth
12 + 6*N	I1	-	elev	-	Elevation
13 + 6*N	X1	-	age	-	Age of Almanac and Ephemeris: (see graphic below)
<i>End of repeated block</i>					

Bitfield svFlag

This graphic explains the bits of svFlag

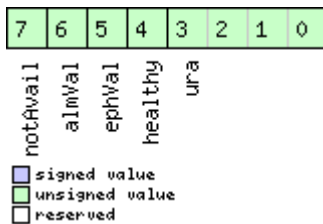

Name	Description
ura	Figure of Merit (URA) range 0..15
healthy	SV healthy flag
ephVal	Ephemeris valid
almVal	Almanac valid
notAvail	SV not available

Bitfield age

This graphic explains the bits of age

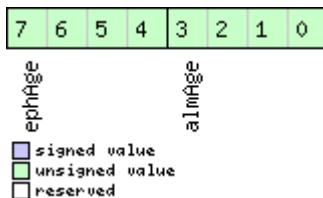

Name	Description
almAge	Age of ALM in days offset by 4 i.e. the reference time may be in the future: ageOfAlm = (age & 0x0f) - 4

Bitfield age Description continued

<i>Name</i>	<i>Description</i>
ephAge	Age of EPH in hours offset by 4. i.e. the reference time may be in the future: $\text{ageOfEph} = (\text{age} \& 0xf0) \gg 4 - 4$

31.20 UBX-SEC (0x27)

Security Feature Messages

Messages in the SEC class are used for security features of the receiver.

31.20.1 UBX-SEC-SIGN (0x27 0x01)

31.20.1.1 Signature of a previous message

<i>Message</i>	SEC-SIGN					
<i>Description</i>	Signature of a previous message					
<i>Firmware</i>	Supported on: <ul style="list-style-type: none"> u-blox 8 / u-blox M8 from protocol version 18 up to version 23.01 					
<i>Type</i>	Output					
<i>Comment</i>	The message is the signature of a previously sent message. The signature is generated with a hash using the SHA-256 algorithm with the programmed seeds.					
<i>Message Structure</i>	<i>Header</i>	<i>Class</i>	<i>ID</i>	<i>Length (Bytes)</i>	<i>Payload</i>	<i>Checksum</i>
	0xB5 0x62	0x27	0x01	40	see below	CK_A CK_B
<i>Payload Contents:</i>						
<i>Byte Offset</i>	<i>Number Format</i>	<i>Scaling</i>	<i>Name</i>	<i>Unit</i>	<i>Description</i>	
0	U1	-	version	-	Message version (0x01 for this version)	
1	U1[3]	-	reserved1	-	Reserved	
4	U1	-	classID	-	Class ID of the referring message	
5	U1	-	messageID	-	Message ID of the referring message	
6	U2	-	checksum	-	UBX Checksum of the referring message	
8	U1[32]	-	hash	-	SHA-256 hash of the referring message	

31.20.2 UBX-SEC-UNIQID (0x27 0x03)

31.20.2.1 Unique Chip ID

<i>Message</i>	SEC-UNIQID					
<i>Description</i>	Unique Chip ID					
<i>Firmware</i>	Supported on: <ul style="list-style-type: none"> u-blox 8 / u-blox M8 from protocol version 18 up to version 23.01 					
<i>Type</i>	Output					
<i>Comment</i>	This message is used to retrieve a unique chip identifier (40 bits, 5 bytes).					
<i>Message Structure</i>	<i>Header</i>	<i>Class</i>	<i>ID</i>	<i>Length (Bytes)</i>	<i>Payload</i>	<i>Checksum</i>
	0xB5 0x62	0x27	0x03	9	see below	CK_A CK_B
<i>Payload Contents:</i>						
<i>Byte Offset</i>	<i>Number Format</i>	<i>Scaling</i>	<i>Name</i>	<i>Unit</i>	<i>Description</i>	
0	U1	-	version	-	Message version (0x01 for this version)	
1	U1[3]	-	reserved1	-	Reserved	
4	U1[5]	-	uniqueId	-	Unique chip ID	

31.21 UBX-TIM (0x0D)

Timing Messages: i.e. Time Pulse Output, Time Mark Results.

Messages in the TIM class are used to output timing information from the receiver, like Time Pulse and Time Mark measurements.

31.21.1 UBX-TIM-DOSC (0x0D 0x11)

31.21.1.1 Disciplined oscillator control

Message		TIM-DOSC					
Description		Disciplined oscillator control					
Firmware		Supported on: <ul style="list-style-type: none"> • u-blox 8 / u-blox M8 from protocol version 16 up to version 23.01 (only with Time & Frequency Sync products) 					
Type		Output					
Comment		The receiver sends this message when it is disciplining an external oscillator and the external oscillator is set up to be controlled via the host.					
Message Structure		Header	Class	ID	Length (Bytes)	Payload	Checksum
		0xB5 0x62	0x0D	0x11	8	see below	CK_A CK_B
Payload Contents:							
Byte Offset	Number Format	Scaling	Name	Unit	Description		
0	U1	-	version	-	Message version (0 for this version)		
1	U1[3]	-	reserved1	-	Reserved		
4	U4	-	value	-	The raw value to be applied to the DAC controlling the external oscillator. The least significant bits should be written to the DAC, with the higher bits being ignored.		

31.21.2 UBX-TIM-FCHG (0x0D 0x16)

31.21.2.1 Oscillator frequency changed notification

Message		TIM-FCHG					
Description		Oscillator frequency changed notification					
Firmware		Supported on: <ul style="list-style-type: none"> • u-blox 8 / u-blox M8 from protocol version 16 up to version 23.01 (only with Time & Frequency Sync products) 					
Type		Periodic/Polled					
Comment		This message reports frequency changes commanded by the sync manager for the internal and external oscillator. It is output at the configured rate even if the sync manager decides not to command a frequency change.					
Message Structure		Header	Class	ID	Length (Bytes)	Payload	Checksum
		0xB5 0x62	0x0D	0x16	32	see below	CK_A CK_B
Payload Contents:							
Byte Offset	Number Format	Scaling	Name	Unit	Description		
0	U1	-	version	-	Message version (0 for this version)		
1	U1[3]	-	reserved1	-	Reserved		

TIM-FCHG continued

Byte Offset	Number Format	Scaling	Name	Unit	Description
4	U4	-	iTOW	ms	GPS time of week of the navigation epoch from which the sync manager obtains the GNSS specific data. Like for the NAV message, the iTOW can be used to group messages of a single sync manager run together (See the description of iTOW for details)
8	I4	2 ⁻⁸	intDeltaFreq	ppb	Frequency increment of the internal oscillator
12	U4	2 ⁻⁸	intDeltaFreqUnc	ppb	Uncertainty of the internal oscillator frequency increment
16	U4	-	intRaw	-	Current raw DAC setting commanded to the internal oscillator
20	I4	2 ⁻⁸	extDeltaFreq	ppb	Frequency increment of the external oscillator
24	U4	2 ⁻⁸	extDeltaFreqUnc	ppb	Uncertainty of the external oscillator frequency increment
28	U4	-	extRaw	-	Current raw DAC setting commanded to the external oscillator

31.21.3 UBX-TIM-HOC (0x0D 0x17)

31.21.3.1 Host oscillator control

Message	TIM-HOC					
Description	Host oscillator control					
Firmware	Supported on: <ul style="list-style-type: none"> • u-blox 8 / u-blox M8 from protocol version 16 up to version 23.01 (only with Time & Frequency Sync products) 					
Type	Input					
Comment	<p>This message can be sent by the host to force the receiver to bypass the disciplining algorithms in the SMGR and carry out the instructed changes to internal or external oscillator frequency. No checks are carried out on the size of the frequency change requested, so normal limits imposed by the SMGR are ignored.</p> <p>It is recommended that the disciplining of that oscillator is disabled before this message is sent (i.e. by clearing the enableInternal or enableExternal flag in the CFG-SMGR message), otherwise the autonomous disciplining processes may cancel the effect of the direct command.</p> <p>Note that the GNSS subsystem may temporarily lose track of some/all satellite signals if a large change of the internal oscillator is made.</p>					
Message Structure	Header	Class	ID	Length (Bytes)	Payload	Checksum
	0xB5 0x62	0x0D	0x17	8	see below	CK_A CK_B
Payload Contents:						
Byte Offset	Number Format	Scaling	Name	Unit	Description	
0	U1	-	version	-	Message version (0 for this version)	

TIM-HOC continued

Byte Offset	Number Format	Scaling	Name	Unit	Description
1	U1	-	oscId	-	Id of oscillator: 0: internal oscillator 1: external oscillator
2	U1	-	flags	-	Flags (see graphic below)
3	U1	-	reserved1	-	Reserved
4	I4	2 ⁻⁸	value	ppb/-	Required frequency offset or raw output, depending on the flags

Bitfield flags

This graphic explains the bits of flags

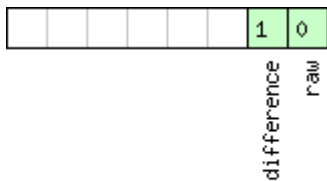

- signed value
- unsigned value
- reserved

Name	Description
raw	Type of value: 0: frequency offset 1: raw digital output
difference	Nature of value: 0: absolute (i.e. relative to 0) 1: relative to current setting

31.21.4 UBX-TIM-SMEAS (0x0D 0x13)

31.21.4.1 Source measurement

Message	TIM-SMEAS					
Description	Source measurement					
Firmware	Supported on: <ul style="list-style-type: none"> • u-blox 8 / u-blox M8 from protocol version 16 up to version 23.01 (only with Time & Frequency Sync products) 					
Type	Input/Output					
Comment	Frequency and/or phase measurement of synchronization sources. The measurements are relative to the nominal frequency and nominal phase. The receiver reports the measurements on its sync sources using this message. Which measurements are reported can be configured using UBX-CFG-SMGR. The host may report offset of the receiver's outputs with this message as well. The receiver has to be configured using UBX-CFG-SMGR to enable the use of the external measurement messages. Otherwise the receiver will ignore them.					
Message Structure	Header	Class	ID	Length (Bytes)	Payload	Checksum
	0xB5 0x62	0x0D	0x13	12 + 24*numMeas	see below	CK_A CK_B
Payload Contents:						

TIM-SMEAS continued

Byte Offset	Number Format	Scaling	Name	Unit	Description
0	U1	-	version	-	Message version (0 for this version)
1	U1	-	numMeas	-	Number of measurements in repeated block
2	U1[2]	-	reserved1	-	Reserved
4	U4	-	iTOW	ms	Time of the week
8	U1[4]	-	reserved2	-	Reserved
<i>Start of repeated block (numMeas times)</i>					
12 + 24*N	U1	-	sourceId	-	Index of source. SMEAS can provide six measurement sources. The first four sourceId values represent measurements made by the receiver and sent to the host. The first of these with a sourceId value of 0 is a measurement of the internal oscillator against the current receiver time-and-frequency estimate. The internal oscillator is being disciplined against that estimate and this result represents the current offset between the actual and desired internal oscillator states. The next three sourceId values represent frequency and time measurements made by the receiver against the internal oscillator. sourceId 1 represents the GNSS-derived frequency and time compared with the internal oscillator frequency and time. sourceId 2 give measurements of a signal coming in on EXTINT0. sourceId 3 corresponds to a similar measurement on EXTINT1. The remaining two of these measurements (sourceId 4 and 5) are made by the host and sent to the receiver. A measurement with sourceId 4 is a measurement by the host of the internal oscillator and sourceId 5 indicates a host measurement of the external oscillator.
13 + 24*N	X1	-	flags	-	Flags (see graphic below)
14 + 24*N	I1	2 ⁻⁸	phaseOffsetFrac	ns	Sub-nanosecond phase offset; the total offset is the sum of phaseOffset and phaseOffsetFrac
15 + 24*N	U1	2 ⁻⁸	phaseUncFrac	ns	Sub-nanosecond phase uncertainty
16 + 24*N	I4	-	phaseOffset	ns	Phase offset, positive if the source lags accurate phase and negative if the source is early
20 + 24*N	U4	-	phaseUnc	ns	Phase uncertainty (one standard deviation)
24 + 24*N	U1[4]	-	reserved3	-	Reserved
28 + 24*N	I4	2 ⁻⁸	freqOffset	ppb	Frequency offset, positive if the source frequency is too high, negative if the frequency is too low.

TIM-SMEAS continued

Byte Offset	Number Format	Scaling	Name	Unit	Description
32 + 24*N	U4	2 ⁻⁸	freqUnc	ppb	Frequency uncertainty (one standard deviation)
End of repeated block					

Bitfield flags

This graphic explains the bits of flags

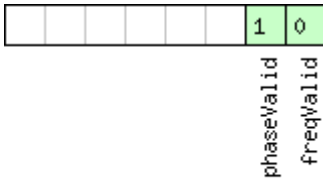

- signed value
- unsigned value
- reserved

Name	Description
freqValid	1 = frequency measurement is valid
phaseValid	1 = phase measurement is valid

31.21.5 UBX-TIM-SVIN (0x0D 0x04)

31.21.5.1 Survey-in data

Message	TIM-SVIN					
Description	Survey-in data					
Firmware	Supported on: <ul style="list-style-type: none"> • u-blox 8 / u-blox M8 from protocol version 15 up to version 23.01 (only with Time & Frequency Sync or Time Sync products) 					
Type	Periodic/Polled					
Comment	This message contains information about survey-in parameters. For details about the Time Mode see section Time Mode Configuration .					
Message Structure	Header	Class	ID	Length (Bytes)	Payload	Checksum
	0xB5 0x62	0x0D	0x04	28	see below	CK_A CK_B
Payload Contents:						
Byte Offset	Number Format	Scaling	Name	Unit	Description	
0	U4	-	dur	s	Passed survey-in observation time	
4	I4	-	meanX	cm	Current survey-in mean position ECEF X coordinate	
8	I4	-	meanY	cm	Current survey-in mean position ECEF Y coordinate	
12	I4	-	meanZ	cm	Current survey-in mean position ECEF Z coordinate	
16	U4	-	meanV	mm ²	Current survey-in mean position 3D variance	
20	U4	-	obs	-	Number of position observations used during survey-in	
24	U1	-	valid	-	Survey-in position validity flag, 1 = valid, otherwise 0	

TIM-SVIN continued

Byte Offset	Number Format	Scaling	Name	Unit	Description
25	U1	-	active	-	Survey-in in progress flag, 1 = in-progress, otherwise 0
26	U1[2]	-	reserved1	-	Reserved

31.21.6 UBX-TIM-TM2 (0x0D 0x03)

31.21.6.1 Time mark data

Message	TIM-TM2					
Description	Time mark data					
Firmware	Supported on: <ul style="list-style-type: none"> u-blox 8 / u-blox M8 from protocol version 15 up to version 23.01 					
Type	Periodic/Polled					
Comment	This message contains information for high precision time stamping / pulse counting. The delay figures and timebase given in CFG-TP5 are also applied to the time results output in this message.					
Message Structure	Header	Class	ID	Length (Bytes)	Payload	Checksum
	0xB5 0x62	0x0D	0x03	28	see below	CK_A CK_B
Payload Contents:						
Byte Offset	Number Format	Scaling	Name	Unit	Description	
0	U1	-	ch	-	Channel (i.e. EXTINT) upon which the pulse was measured	
1	X1	-	flags	-	Bitmask (see graphic below)	
2	U2	-	count	-	rising edge counter.	
4	U2	-	wnR	-	week number of last rising edge	
6	U2	-	wnF	-	week number of last falling edge	
8	U4	-	towMsR	ms	tow of rising edge	
12	U4	-	towSubMsR	ns	millisecond fraction of tow of rising edge in nanoseconds	
16	U4	-	towMsF	ms	tow of falling edge	
20	U4	-	towSubMsF	ns	millisecond fraction of tow of falling edge in nanoseconds	
24	U4	-	accEst	ns	Accuracy estimate	

Bitfield flags

This graphic explains the bits of flags

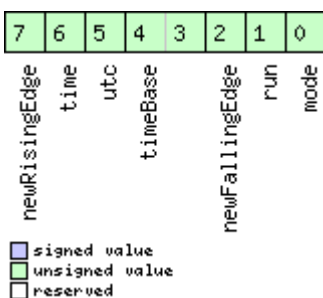

Bitfield flags Description continued

Name	Description
Name	Description
mode	0=single 1=running
run	0=armed 1=stopped
newFallingEdge	new falling edge detected
timeBase	0=Time base is Receiver Time 1=Time base is GNSS Time (the system according to the configuration in CFG-TP5 for tpldx=0) 2=Time base is UTC (the variant according to the configuration in CFG-NAV5)
utc	0=UTC not available 1=UTC available
time	0=Time is not valid 1=Time is valid (Valid GNSS fix)
newRisingEdge	new rising edge detected

31.21.7 UBX-TIM-TOS (0x0D 0x12)

31.21.7.1 Time Pulse Time and Frequency Data

Message	TIM-TOS					
Description	Time Pulse Time and Frequency Data					
Firmware	Supported on: <ul style="list-style-type: none"> u-blox 8 / u-blox M8 from protocol version 16 up to version 23.01 (only with Time & Frequency Sync products) 					
Type	Periodic					
Comment	This message contains information about the time pulse that has just happened and the state of the disciplined oscillators(s) at the time of the pulse. It gives the UTC and GNSS times and time uncertainty of the pulse together with frequency and frequency uncertainty of the disciplined oscillators. It also supplies leap second information.					
Message Structure	Header	Class	ID	Length (Bytes)	Payload	Checksum
	0xB5 0x62	0x0D	0x12	56	see below	CK_A CK_B
Payload Contents:						
Byte Offset	Number Format	Scaling	Name	Unit	Description	
0	U1	-	version	-	Message version (0 for this version)	
1	U1	-	gnssId	-	GNSS system used for reporting GNSS time (see Satellite Numbering)	
2	U1[2]	-	reserved1	-	Reserved	
4	X4	-	flags	-	Flags (see graphic below)	
8	U2	-	year	y	Year of UTC time	
10	U1	-	month	month	Month of UTC time	
11	U1	-	day	d	Day of UTC time	
12	U1	-	hour	h	Hour of UTC time	
13	U1	-	minute	min	Minute of UTC time	
14	U1	-	second	s	Second of UTC time	

TIM-TOS continued

Byte Offset	Number Format	Scaling	Name	Unit	Description
15	U1	-	utcStandard	-	UTC standard identifier: 0: unknown 3: UTC as operated by the U.S. Naval Observatory (USNO) 6: UTC as operated by the former Soviet Union 7: UTC as operated by the National Time Service Center, China
16	I4	-	utcOffset	ns	Time offset between the preceding pulse and UTC top of second
20	U4	-	utcUncertainty	ns	Uncertainty of utcOffset
24	U4	-	week	-	GNSS week number
28	U4	-	TOW	s	GNSS time of week
32	I4	-	gnssOffset	ns	Time offset between the preceding pulse and GNSS top of second
36	U4	-	gnssUncertainty	ns	Uncertainty of gnssOffset
40	I4	2 ⁻⁸	intOscOffset	ppb	Internal oscillator frequency offset
44	U4	2 ⁻⁸	intOscUncertainty	ppb	Internal oscillator frequency uncertainty
48	I4	2 ⁻⁸	extOscOffset	ppb	External oscillator frequency offset
52	U4	2 ⁻⁸	extOscUncertainty	ppb	External oscillator frequency uncertainty

Bitfield flags

This graphic explains the bits of flags

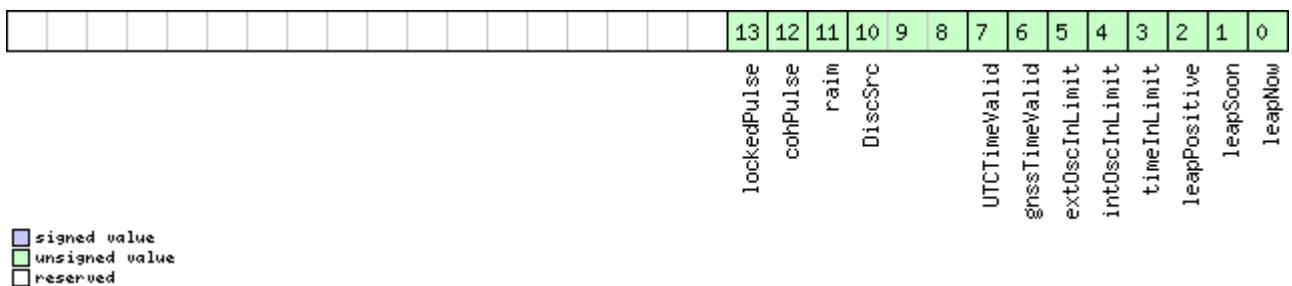

Name	Description
leapNow	1 = currently in a leap second
leapSoon	1 = leap second scheduled in current minute
leapPositive	1 = positive leap second
timeInLimit	1 = time pulse is within tolerance limit (CFG-SMGR timeTolerance field)
intOscInLimit	1 = internal oscillator is within tolerance limit (CFG-SMGR freqTolerance field)
extOscInLimit	1 = external oscillator is within tolerance limit (CFG-SMGR freqTolerance field)
gnssTimeValid	1 = GNSS time is valid
UTCTimeValid	1 = UTC time is valid

Bitfield flags Description continued

Name	Description
DiscSrc	Disciplining source identifier: 0: internal oscillator 1: GNSS 2: EXTINT0 3: EXTINT1 4: internal oscillator measured by the host 5: external oscillator measured by the host
raim	1 = (T)RAIM system is currently active. Note this flag only reports the current state of the GNSS solution; it is not affected by whether or not the GNSS solution is being used to discipline the oscillator.
cohPulse	1 = coherent pulse generation is currently in operation
lockedPulse	1 = time pulse is locked

31.21.8 UBX-TIM-TP (0x0D 0x01)
31.21.8.1 Time Pulse Timedata

Message	TIM-TP					
Description	Time Pulse Timedata					
Firmware	Supported on: <ul style="list-style-type: none"> u-blox 8 / u-blox M8 from protocol version 15 up to version 22 					
Type	Periodic/Polled					
Comment	This message contains information for high precision timing. The recommended configuration when using this message is to set both the measurement rate (CFG-RATE) and the timepulse frequency (CFG-TP5) to 1Hz. For more information see section Time pulse .					
Message Structure	Header	Class	ID	Length (Bytes)	Payload	Checksum
	0xB5 0x62	0x0D	0x01	16	see below	CK_A CK_B
Payload Contents:						
Byte Offset	Number Format	Scaling	Name	Unit	Description	
0	U4	-	towMS	ms	Time pulse time of week according to time base	
4	U4	2 ⁻³²	towSubMS	ms	Submillisecond part of TOWMS	
8	I4	-	qErr	ps	Quantization error of time pulse (not supported for the FTS product variant).	
12	U2	-	week	weeks	Time pulse week number according to time base	
14	X1	-	flags	-	bitmask (see graphic below)	
15	X1	-	refInfo	-	Time reference information (see graphic below)	

Bitfield flags

This graphic explains the bits of `flags`

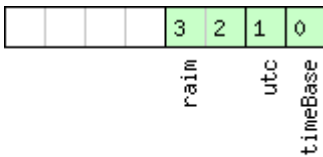

signed value
 unsigned value
 reserved

Name	Description
timeBase	0=Time base is GNSS 1=Time base is UTC
utc	0=UTC not available 1=UTC available
raim	(T)RAIM information 0=information not available 1=not active 2=active

Bitfield refInfo

This graphic explains the bits of `refInfo`

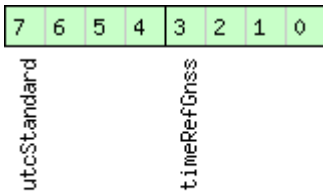

signed value
 unsigned value
 reserved

Name	Description
timeRefGnss	GNSS reference information (only active if time base is GNSS -> timeBase=0) 0: GPS 1: GLONASS 2: BeiDou 15: Unknown
utcStandard	UTC standard identifier (only active if time base is UTC -> timeBase=1) 0: Information not available 1: Communications Research Laboratory (CRL) 2: National Institute of Standards and Technology (NIST) 3: U.S. Naval Observatory (USNO) 4: International Bureau of Weights and Measures (BIPM) 5: European Laboratory (tbd) 6: Former Soviet Union (SU) 15: Unknown

31.21.9 UBX-TIM-VCOCAL (0x0D 0x15)

31.21.9.1 Stop calibration

Message	TIM-VCOCAL					
Description	Stop calibration					
Firmware	Supported on: <ul style="list-style-type: none"> u-blox 8 / u-blox M8 from protocol version 16 up to version 23.01 (only with Time & Frequency Sync products) 					
Type	Command					
Comment	Stop all ongoing calibration (both oscillators are affected)					
Message Structure	Header	Class	ID	Length (Bytes)	Payload	Checksum
	0xB5 0x62	0x0D	0x15	1	see below	CK_A CK_B
Payload Contents:						
Byte Offset	Number Format	Scaling	Name	Unit	Description	
0	U1	-	type	-	Message type (0 for this message)	

31.21.9.2 VCO calibration extended command

Message	TIM-VCOCAL				
Description	VCO calibration extended command				
Firmware	Supported on: <ul style="list-style-type: none"> u-blox 8 / u-blox M8 from protocol version 16 up to version 23.01 (only with Time & Frequency Sync products) 				
Type	Command				
Comment	<p>Calibrate (measure) gain of the voltage controlled oscillator. The calibration is performed by varying the raw oscillator control values between the limits specified in raw0 and raw1. maxStepSize is the largest step change that can be used during the calibration process. The "raw values" are either PWM duty cycle values or DAC values depending on how the VCTCXO is connected to the system. The measured gain is the transfer function $dRelativeFrequencyChange/dRaw$ (not $dFrequency/dVoltage$). The calibration process works as follows:</p> <p>Starting from the current raw output the control value is changed in the direction of raw0 in steps of size at most maxStepSize. Then the frequency is measured and the control value is changed towards raw1, again in steps of maxStepSize. When raw1 is reached, the frequency is again measured and the message version DATA0 is output containing the measured result. Normal operation then resumes. If the control value movement is less than maxStepSize then the transition will happen in one step - this will give fast calibration.</p> <p>Care must be taken when calibrating the internal oscillator against the GNSS source. In that case the changes applied to the oscillator frequency could be severe enough to lose satellite signal tracking, especially when signals are weak. If too many signals are lost, the GNSS system will lose its fix and be unable to measure the oscillator frequency - the calibration will then fail. In this case maxStepSize must be reasonably small.</p> <p>It is also important that only the chosen frequency source is enabled during the calibration process and that it remains stable throughout the calibration period; otherwise incorrect oscillator measurements will be made and this will lead to miscalibration and poor subsequent operation of the receiver.</p>				

		Header	Class	ID	Length (Bytes)	Payload	Checksum
Message Structure		0xB5 0x62	0x0D	0x15	12	see below	CK_A CK_B
Payload Contents:							
Byte Offset	Number Format	Scaling	Name	Unit	Description		
0	U1	-	type	-	Message type (2 for this message)		
1	U1	-	version	-	Message version (0 for this version)		
2	U1	-	oscId	-	Oscillator to be calibrated: 0: internal oscillator 1: external oscillator		
3	U1	-	srcId	-	Reference source: 0: internal oscillator 1: GNSS 2: EXTINT0 3: EXTINT1 Option 0 should be used when calibrating the external oscillator. Options 1-3 should be used when calibrating the internal oscillator.		
4	U1[2]	-	reserved1	-	Reserved		
6	U2	-	raw0	-	First value used for calibration		
8	U2	-	raw1	-	Second value used for calibration		
10	U2	-	maxStepSize	raw value/s	Maximum step size to be used		

31.21.9.3 Results of the calibration

Message	TIM-VCOCAL						
Description	Results of the calibration						
Firmware	Supported on: <ul style="list-style-type: none"> u-blox 8 / u-blox M8 from protocol version 16 up to version 23.01 (only with Time & Frequency Sync products) 						
Type	Periodic/Polled						
Comment	This message is sent when the oscillator gain calibration process is finished (successful or unsuccessful). It notifies the user of the calibrated oscillator gain. If the oscillator gain calibration process was successful, this message will contain the measured gain (field gainVco) and its uncertainty (field gainUncertainty). The calibration process can however fail. In that case the two fields gainVco and gainUncertainty are set to zero.						
		Header	Class	ID	Length (Bytes)	Payload	Checksum
Message Structure		0xB5 0x62	0x0D	0x15	12	see below	CK_A CK_B
Payload Contents:							
Byte Offset	Number Format	Scaling	Name	Unit	Description		
0	U1	-	type	-	Message type (3 for this message)		
1	U1	-	version	-	Message version (0 for this version)		
2	U1	-	oscId	-	Id of oscillator: 0: internal oscillator 1: external oscillator		

TIM-VCOCAL continued

Byte Offset	Number Format	Scaling	Name	Unit	Description
3	U1[3]	-	reserved1	-	Reserved
6	U2	2 ⁻¹⁶	gainUncertainty	1/1	Relative gain uncertainty after calibration, 0 if calibration failed
8	I4	2 ⁻¹⁶	gainVco	ppb/raw LSB	Calibrated gain or 0 if calibration failed

31.21.10 UBX-TIM-VRFY (0x0D 0x06)

31.21.10.1 Sourced Time Verification

Message	TIM-VRFY					
Description	Sourced Time Verification					
Firmware	Supported on: <ul style="list-style-type: none"> u-blox 8 / u-blox M8 from protocol version 15 up to version 23.01 					
Type	Periodic/Polled					
Comment	This message contains verification information about previous time received via AID-INI or from RTC					
Message Structure	Header	Class	ID	Length (Bytes)	Payload	Checksum
	0xB5 0x62	0x0D	0x06	20	see below	CK_A CK_B
Payload Contents:						
Byte Offset	Number Format	Scaling	Name	Unit	Description	
0	I4	-	itow	ms	integer millisecond tow received by source	
4	I4	-	frac	ns	sub-millisecond part of tow	
8	I4	-	deltaMs	ms	integer milliseconds of delta time (current time minus sourced time)	
12	I4	-	deltaNs	ns	sub-millisecond part of delta time	
16	U2	-	wno	week	week number	
18	X1	-	flags	-	information flags (see graphic below)	
19	U1	-	reserved1	-	Reserved	

Bitfield flags

This graphic explains the bits of flags

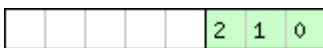

- signed value
- unsigned value
- reserved

Name	Description
src	aiding time source 0: no time aiding done 2: source was RTC 3: source was AID-INI

31.22 UBX-UPD (0x09)

Firmware Update Messages: i.e. Memory/Flash erase/write, Reboot, Flash identification, etc..

Messages in the UPD class are used to update the firmware and identify any attached flash device.

31.22.1 UBX-UPD-SOS (0x09 0x14)

31.22.1.1 Poll Backup File Restore Status

Message	UPD-SOS					
Description	Poll Backup File Restore Status					
Firmware	Supported on: <ul style="list-style-type: none"> u-blox 8 / u-blox M8 from protocol version 15 up to version 23.01 					
Type	Poll Request					
Comment	Sending this (empty / no-payload) message to the receiver results in the receiver returning a <i>System Restored from Backup</i> message as defined below.					
Message Structure	Header	Class	ID	Length (Bytes)	Payload	Checksum
	0xB5 0x62	0x09	0x14	0	see below	CK_A CK_B
No payload						

31.22.1.2 Create Backup File in Flash

Message	UPD-SOS					
Description	Create Backup File in Flash					
Firmware	Supported on: <ul style="list-style-type: none"> u-blox 8 / u-blox M8 from protocol version 15 up to version 23.01 					
Type	Command					
Comment	The host can send this message in order to save part of the BBR memory in a file in flash file system. The feature is designed in order to emulate the presence of the backup battery even if it is not present; the host can issue the save on shutdown command before switching off the device supply. It is recommended to issue a GNSS stop command before, in order to keep the BBR memory content consistent.					
Message Structure	Header	Class	ID	Length (Bytes)	Payload	Checksum
	0xB5 0x62	0x09	0x14	4	see below	CK_A CK_B
Payload Contents:						
Byte Offset	Number Format	Scaling	Name	Unit	Description	
0	U1	-	cmd	-	Command (must be 0)	
1	U1[3]	-	reserved1	-	Reserved	

31.22.1.3 Clear Backup in Flash

<i>Message</i>		UPD-SOS					
<i>Description</i>		Clear Backup in Flash					
<i>Firmware</i>		Supported on: <ul style="list-style-type: none"> u-blox 8 / u-blox M8 from protocol version 15 up to version 23.01 					
<i>Type</i>		Command					
<i>Comment</i>		The host can send this message in order to erase the backup file present in flash. It is recommended that the clear operation is issued after the host has received the notification that the memory has been restored after a reset. Alternatively the host can parse the startup string 'Restored data saved on shutdown' or poll the UBX-UPD-SOS message for getting the status.					
<i>Message Structure</i>		<i>Header</i>	<i>Class</i>	<i>ID</i>	<i>Length (Bytes)</i>	<i>Payload</i>	<i>Checksum</i>
		0xB5 0x62	0x09	0x14	4	see below	CK_A CK_B
<i>Payload Contents:</i>							
<i>Byte Offset</i>	<i>Number Format</i>	<i>Scaling</i>	<i>Name</i>	<i>Unit</i>	<i>Description</i>		
0	U1	-	cmd	-	Command (must be 1)		
1	U1[3]	-	reserved1	-	Reserved		

31.22.1.4 Backup File Creation Acknowledge

<i>Message</i>		UPD-SOS					
<i>Description</i>		Backup File Creation Acknowledge					
<i>Firmware</i>		Supported on: <ul style="list-style-type: none"> u-blox 8 / u-blox M8 from protocol version 15 up to version 23.01 					
<i>Type</i>		Output					
<i>Comment</i>		The message is sent from the device as confirmation of creation of a backup file in flash. The host can safely shut down the device after received this message.					
<i>Message Structure</i>		<i>Header</i>	<i>Class</i>	<i>ID</i>	<i>Length (Bytes)</i>	<i>Payload</i>	<i>Checksum</i>
		0xB5 0x62	0x09	0x14	8	see below	CK_A CK_B
<i>Payload Contents:</i>							
<i>Byte Offset</i>	<i>Number Format</i>	<i>Scaling</i>	<i>Name</i>	<i>Unit</i>	<i>Description</i>		
0	U1	-	cmd	-	Command (must be 2)		
1	U1[3]	-	reserved1	-	Reserved		
4	U1	-	response	-	0: Not acknowledged 1: Acknowledged		
5	U1[3]	-	reserved2	-	Reserved		

31.22.1.5 System Restored from Backup

<i>Message</i>	UPD-SOS					
<i>Description</i>	System Restored from Backup					
<i>Firmware</i>	Supported on: <ul style="list-style-type: none"> • u-blox 8 / u-blox M8 from protocol version 15 up to version 23.01 					
<i>Type</i>	Output					
<i>Comment</i>	The message is sent from the device to notify the host the BBR has been restored from a backup file in flash. The host should clear the backup file after receiving this message. If the UBX-UPD-SOS message is polled, this message will be resent.					
<i>Message Structure</i>	<i>Header</i>	<i>Class</i>	<i>ID</i>	<i>Length (Bytes)</i>	<i>Payload</i>	<i>Checksum</i>
	0xB5 0x62	0x09	0x14	8	see below	CK_A CK_B
<i>Payload Contents:</i>						
<i>Byte Offset</i>	<i>Number Format</i>	<i>Scaling</i>	<i>Name</i>	<i>Unit</i>	<i>Description</i>	
0	U1	-	cmd	-	Command (must be 3)	
1	U1[3]	-	reserved1	-	Reserved	
4	U1	-	response	-	0: Unknown 1: Failed restoring from backup file 2: Restored from backup file 3: Not restored (no backup)	
5	U1[3]	-	reserved2	-	Reserved	

32 RTCM Protocol

The RTCM (Radio Technical Commission for Maritime Services) protocol is a unidirectional protocol (input to the receiver) that is used to supply the GNSS receiver with real-time differential correction data. The RTCM protocol specification is available from <http://www.rtcn.org>.

32.1 RTCM2

32.1.1 Introduction



This feature is only applicable to GPS operation.



This feature only supports code differential positioning.



For effective differential positioning accuracy, it is necessary that the reference station antenna is situated in a low multipath environment with an unobstructed view of the sky. It is recommended that reference receiver applies phase smoothing to the broadcast corrections.



This feature is not available with the High Precision GNSS products.

32.1.2 Supported Messages

The following RTCM 2.3 messages are supported:

Supported RTCM 2.3 Message Types

Message Type	Description
1	Differential GPS Corrections
2	Delta Differential GPS Corrections
3	GPS Reference Station Parameters
9	GPS Partial Correction Set

32.1.3 Configuration

The DGPS feature does not need any configuration to work properly. When an RTCM stream is input on any of the communication interfaces, the data will be parsed and applied if possible, which will put the receiver into DGPS mode.

The only configurable parameter of DGPS mode is the timeout that can be specified using `UBX-CFG-NAV5`. This value defines the time after which old RTCM data will be discarded.

The RTCM protocol can be disabled/enabled on communication interfaces by means of the `UBX-CFG-PRT` message. By default, RTCM is enabled.

32.1.4 Output

DGPS mode will result in following modified output:

- `NMEA-GGA`: The quality field will be 2 (see [NMEA Position Fix Flags](#)). The age of DGPS corrections and Reference station ID will be set.
- `NMEA-GLL`, `NMEA-RMC`, `NMEA-VTG`, `NMEA-GNS`: The posMode indicator will be D (see [NMEA Position Fix Flags](#)).
- `NMEA-PUBX-POSITION`: The status will be D2/D3; The age of DGPS corrections will be set.

- **UBX-NAV-SOL**: The DGPS flag will be set.
- **UBX-NAV-PVT**: The diffSoln flag will be set.
- **UBX-NAV-STATUS**: The diffSoln flag will be set; the diffCorr flag will be set.
- **UBX-NAV-SVINFO**: The DGPS flag will be set for channels with valid DGPS correction data.
- **UBX-NAV-DGPS**: This message will contain all valid DGPS data
- If the base line exceeds 100km and a message type 3 is received, a **UBX-INF-WARNING** will be output, e.g. "WARNING: DGNSS baseline big: 330.3km"

32.1.5 Restrictions

The following restrictions apply to DGPS mode:

- The DGPS solution will only include measurements from satellites for which DGPS corrections were provided. This is because the navigation algorithms cannot mix corrected with uncorrected measurements.
- **SBAS corrections** will not be applied when using RTCM correction data.
- Precise Point Positioning will be deactivated when using RTCM correction data.
- RTCM correction data cannot be applied when using *AssistNow Offline* or *AssistNow Autonomous*.

32.1.6 Reference

The RTCM2 support is implemented according to RTCM 10402.3 ("RECOMMENDED STANDARDS FOR DIFFERENTIAL GNSS").

32.2 RTCM3

(Note: the RTCM3 protocol is not supported in [protocol versions less than 20](#)).

32.2.1 Introduction



This feature is only available with High Precision GNSS products.



This feature is only applicable to GPS, GLONASS or BeiDou operation.



This feature supports carrier phase differential positioning.



For effective differential positioning accuracy, it is necessary that the reference station antenna is situated in a low multipath environment with an unobstructed view of the sky and continuous phase lock on all visible satellites.



RTCM3 messages can also be transmitted through NTRIP (Networked Transport of RTCM via Internet Protocol). u-center incorporates an NTRIP client and an NTRIP server/caster.

32.2.2 Supported Messages

The following RTCM 3.2 input messages are supported:

Supported RTCM 3.2 Input Messages

Message Type	Description
1001	L1-only GPS RTK observations
1002	Extended L1-only GPS RTK observations
1003	L1/L2 GPS RTK observations
1004	Extended L1/L2 GPS RTK observations

Supported RTCM 3.2 Input Messages continued

Message Type	Description
1005	Stationary RTK reference station ARP
1006	Stationary RTK reference station ARP with antenna height
1007	Antenna descriptor
1009	L1-only GLONASS RTK observations
1010	Extended L1-only GLONASS RTK observations
1011	L1/L2 GLONASS RTK observations
1012	Extended L1/L2 GLONASS RTK observations
1074	GPS MSM4
1075	GPS MSM5
1077	GPS MSM7
1084	GLONASS MSM4
1085	GLONASS MSM5
1087	GLONASS MSM7
1124	BeiDou MSM4
1125	BeiDou MSM5
1127	BeiDou MSM7
1230	GLONASS code-phase biases
4072, sub-type 0	Reference station PVT (u-blox proprietary RTCM Message)

The following RTCM 3.2 output messages are supported:

When configuring RTCM output messages using the UBX protocol message `CFG-MSG`, the Class/Ids shown in the table shall be used.

Supported RTCM 3.2 Output Messages

Message Type	Cls/ID	Description
1005	0xF5 0x05	Stationary RTK reference station ARP
1074	0xF5 0x4A	GPS MSM4
1077	0xF5 0x4D	GPS MSM7
1084	0xF5 0x54	GLONASS MSM4
1087	0xF5 0x57	GLONASS MSM7
1124	0xF5 0x7C	BeiDou MSM4
1127	0xF5 0x7F	BeiDou MSM7
1230	0xF5 0xE6	GLONASS code-phase biases
4072, sub-type 0	0xF5 0xFE	Reference station PVT (u-blox proprietary RTCM Message)

32.2.3 u-blox Proprietary RTCM Messages

The RTCM message type 4072 is the u-blox proprietary RTCM message. It is supported by the RTCM standard version 3.2 and above.

32.2.3.1 Sub-Types

There are different available sub-types of the RTCM message type 4072. The table below shows the available RTCM 4072 sub-types.

RTCM 4072 Sub-Types

Sub-Type	Message Type Number	Sub-Type Number	Description	Message Data (Payload)Length (bits)
0	0xFE8	0x000	Reference station PVT	1008+48*(no. of constellations - 1)

32.2.3.1.1 Sub-Type 0 (0xFE8 0x000)

RTCM Message type 4072, sub-type 0: Reference station PVT

32.2.4 Configuration

The configuration of the RTK rover and reference station is explained in the [RTK Mode Configuration](#) section.

The RTCM3 protocol can be disabled/enabled on communication interfaces by means of the [UBX-CFG-PRT](#) message. By default, RTCM3 is enabled.

The configuration of the RTCM3 correction stream must be done according to the following rules:

- The RTCM3 stream must contain only one reference station message (type 1005, type 1006, or [type 4072, sub-type 0](#)) in addition to the GPS, GLONASS or BeiDou observation messages.
- All observation messages must be broadcast at the same rate.
- The reference station ID field in the GPS, GLONASS or BeiDou observation messages must be consistent with the reference station ID field in the reference station message otherwise the rover will not be able to compute its position.
- The RTCM3 stream must contain the GLONASS code-phase biases message (type 1230) otherwise the GLONASS ambiguities can only be estimated as float, even in RTK fixed mode.
- The static reference station message (type 1005 or type 1006) does not need to be broadcast at the same rate as the observation messages but the rover will not be able to compute its position until it has received a valid reference station message.
- The moving baseline reference message ([type 4072, sub-type 0](#)) must be broadcast at the same rate as the observation messages.
- The RTCM3 stream should only contain one type of observation messages per constellation. When using a multi-constellation configuration, all constellations should use the same type of observation messages. Mixing RTK and MSM messages will result in undefined rover behavior.
- The moving baseline reference message ([type 4072, sub-type 0](#)) must be used in combination with MSM7 observation messages.
- If the receiver is configured to output RTCM messages on several ports, they must all have the same RTCM configuration otherwise the MSM multiple message bit might not be set properly.

32.2.5 Output

RTK Rover and MB Rover Modes will result in following modified output:

- [NMEA-GGA](#): The quality field will be 4 for RTK fixed and 5 for RTK float (see [NMEA Positon Fix Flags](#)). The age of differential corrections and reference station ID will be set.
- [NMEA-GLL](#), [NMEA-VTG](#): The posMode indicator will be D for RTK float and RTK fixed (see [NMEA Positon Fix Flags](#)).
- [NMEA-RMC](#), [NMEA-GNS](#): The posMode indicator will be F for RTK float and R for RTK fixed (see [NMEA Positon Fix Flags](#)).
- [UBX-NAV-PVT](#): The carrSoln flag will be set to 1 for RTK float and 2 for RTK fixed.
- [UBX-NAV-RELPOSNED](#): The diffSoln and refPosValid flags will be set. The carrSoln flag will be set to 1 for RTK float and 2 for RTK fixed. In moving baseline rover mode, the isMoving flag will be set, and the

refPosMiss and refObsMiss flags will be set for epochs during which extrapolated reference position or observations have been used.

- **UBX-NAV-SAT**: The diffCorr flag will be set for satellites with valid RTCM data. The rcmCorrUsed, prCorrUsed, and crCorrUsed flags will be set for satellites for which the RTCM corrections have been applied. In moving baseline rover mode, the doCorrUsed flag will also be set.
- **UBX-NAV-STATUS**: The diffSoln flag will be set; the diffCorr flag will be set.
- If the baseline exceeds 10km and a message type 1005, type 1006 or **type 4072, sub-type 0** is received, a **UBX-INF-WARNING** will be output, e.g. "WARNING: DGNSS baseline big: 12.7km"

32.2.6 Reference

The RTCM3 support is implemented according to RTCM STANDARD 10403.2 DIFFERENTIAL GNSS (GLOBAL NAVIGATION SATELLITE SYSTEMS) SERVICES - VERSION 3.

Appendix

A Satellite Numbering

A summary of all the SV numbering schemes is provided in the following table.

Satellite numbering

GNSS Type	SV range	UBX gnssId:svId	UBX svId	NMEA 2.X-4.0 0 (strict)	NMEA 2.X-4.0 (extended)	NMEA 4.1+ (strict)	NMEA 4.1+ (extended)
GPS	G1-G32	0:1-32	1-32	1-32	1-32	1-32	1-32
SBAS	S120-S158	1:120-158	120-158	33-64	33-64,152-158	33-64	33-64,152-158
Galileo	E1-E36	2:1-36	211-246	-	301-336	1-36	1-36
BeiDou	B1-B37	3:1-37	159-163,33-64	-	401-437	1-37	1-37
IMES	I1-I10	4:1-10	173-182	-	173-182	-	173-182
QZSS	Q1-Q5	5:1-5	193-197	-	193-197	-	193-197
GLONASS	R1-R32, R?	6:1-32, 6:255	65-96, 255	65-96, null	65-96, null	65-96, null	65-96, null

B u-blox 8 / u-blox M8 Default Settings

The default settings listed in this section apply to u-blox 8 / u-blox M8 receivers. These values assume that the default levels of the configuration pins have been left unchanged and no setting that affects the default configuration was written to the eFuse. Default settings are dependent on the configuration pin and eFuse settings. For information regarding these settings, consult the applicable Data Sheet.



If nothing else is mentioned, the default settings apply to u-blox 8 and u-blox M8 receivers.

B.1 Antenna Supervisor Settings (UBX-CFG-ANT)

For parameter and protocol description see section [UBX-CFG-ANT](#).

Antenna Supervisor Default Settings

Parameter	SPG 2.xx	SPG 3.xx, HPG 1.xx	ADR 3.xx, ADR 4.xx, UDR 1.xx	FTS 1.xx	TIM 1.0x	TIM 1.1x
flags-svcs	1	1	1	0	1	1
flags-scd	1	1	0	0	1	0
flags-pdwnOnSCD	1	1	0	0	0	0
flags-recovery	1	1	0	0	1	0
flags-ocd	0	0	0	0	0	0
pins-pinSwitch	16	16	16	31	16	16
pins-pinSCD	15	15	31	31	15	15
pins-pinOCD	31	14	31	31	31	14

B.2 Datum Settings (UBX-CFG-DAT)

For parameter and protocol description see section [UBX-CFG-DAT](#).

Datum Default Settings

Parameter	SPG 2.xx, SPG 3.xx, ADR 3.xx, FTS 1.xx, TIM 1.xx, ADR 4.xx, UDR 1.xx, HPG 1.xx
datumNum	0
datumName	WGS84

Datum Default Settings continued

Parameter	SPG 2.xx, SPG 3.xx, ADR 3.xx, FTS 1.xx, TIM 1.xx, ADR 4.xx, UDR 1.xx, HPG 1.xx
majA	6378137
flat	298.257223563
dX	0
dY	0
dZ	0
rotX	0
rotY	0
rotZ	0
scale	0

B.3 GNSS System Settings (UBX-CFG-GNSS)

For parameter and protocol description see section [UBX-CFG-GNSS](#).

GNSS System Default Settings

Parameter	SPG 2.xx	SPG 3.0x	ADR 3.xx, ADR 4.xx, UDR 1.xx	FTS 1.xx	TIM 1.0x	TIM 1.1x, SPG 3.5x	HPG 1.xx
numTrkChHw	32	32	32	32	32	32	32
numTrkChUse	32	32	32	32	32	32	28
numConfigBlocks	5	7	5	5	6	7	4
gnssId	0, 1, 3, 5, 6	0, 1, 2, 3, 4, 5, 6	0, 1, 3, 5, 6	0, 1, 3, 5, 6	0, 1, 3, 4, 5, 6	0, 1, 2, 3, 4, 5, 6	0, 3, 5, 6
flags-enable	1, 1, 0, 1, 1	1, 1, 0, 0, 0, 1, 1	1, 1, 0, 1, 1	1, 0, 0, 1, 1	1, 0, 0, 0, 1, 1	1, 0, 0, 0, 0, 1, 1	1, 0, 1, 1
resTrkCh	8, 1, 8, 0, 8	8, 1, 4, 8, 0, 0, 8	8, 1, 8, 0, 8	8, 1, 8, 0, 8	8, 1, 8, 0, 0, 8	8, 1, 4, 8, 0, 0, 8	8, 8, 0, 8
maxTrkCh	16, 3, 16, 3, 14	16, 3, 8, 16, 8, 3, 14	16, 3, 16, 3, 14	16, 3, 16, 3, 14	16, 3, 16, 8, 3, 14	16, 3, 8, 16, 8, 3, 14	16, 16, 3, 14

B.4 INF Messages Settings (UBX-CFG-INF)

For parameter and protocol description see section [UBX-CFG-INF](#).

B.4.1 UBX Protocol

INF Messages Default Settings for UBX protocol

Parameter	SPG 2.xx, SPG 3.xx, FTS 1.xx, TIM 1.xx, HPG 1.xx	ADR 3.xx, ADR 4.xx, UDR 1.xx
infMsgMask-ERROR	0,0,0,0,0,0	1,1,1,1,1,1
infMsgMask-WARNING	0,0,0,0,0,0	1,1,1,1,1,1
infMsgMask-NOTICE	0,0,0,0,0,0	1,1,1,1,1,1
infMsgMask-TEST	0,0,0,0,0,0	1,1,1,1,1,1
infMsgMask-DEBUG	0,0,0,0,0,0	1,1,1,1,1,1

B.4.2 NMEA Protocol

INF Messages Default Settings for NMEA protocol

Parameter	SPG 2.xx, TIM 1.0x, FTS 1.xx	SPG 3.xx, TIM 1.1x, HPG 1.xx	ADR 3.xx, ADR 4.xx, UDR 1.xx
infMsgMask-ERROR	1,1,1,1,1,1	1,1,0,1,1,0	0,0,0,0,0,0
infMsgMask-WARNING	1,1,1,1,1,1	1,1,0,1,1,0	0,0,0,0,0,0
infMsgMask-NOTICE	1,1,1,1,1,1	1,1,0,1,1,0	0,0,0,0,0,0
infMsgMask-TEST	0,0,0,0,0,0	0,0,0,0,0,0	0,0,0,0,0,0
infMsgMask-DEBUG	0,0,0,0,0,0	0,0,0,0,0,0	0,0,0,0,0,0

B.5 Jammer/Interference Monitor Settings (UBX-CFG-ITFM)

For parameter and protocol description see section [UBX-CFG-ITFM](#).

Jamming/Interference Monitor Default Settings

Parameter	SPG 2.xx, SPG 3.xx, ADR 3.xx, FTS 1.xx, TIM 1.xx, ADR 4.xx, UDR 1.xx, HPG 1.xx
config-bbThreshold	3
config-cwThreshold	15
config-enable	0
config2-antSetting	0
config2-enable2	0

B.6 Logging Settings (UBX-CFG-LOGFILTER)

For parameter and protocol description see section [UBX-CFG-LOGFILTER](#).

Logging Default Settings

Parameter	SPG 2.xx, SPG 3.xx, ADR 3.xx, FTS 1.xx, TIM 1.xx, ADR 4.xx, UDR 1.xx, HPG 1.xx
flags-recordEnabled	0
flags-psmOncePerWakeupEnabled	0
flags-applyAllFilterSettings	0
minInterval	0
timeThreshold	0
speedThreshold	0
positionThreshold	0

B.7 Navigation Settings (UBX-CFG-NAV5)

For parameter and protocol description see section [UBX-CFG-NAV5](#).

Navigation Default Settings

Parameter	SPG 2.xx	SPG 3.xx	ADR 3.xx, ADR 4.xx, UDR 1.xx	FTS 1.xx	TIM 1.0x	TIM 1.1x	HPG 1.xx
mask-dyn	1	1	1	1	1	1	1
mask-minEl	1	1	1	1	1	1	1
mask-posFixMode	1	1	1	1	1	1	1
mask-drLim	1	1	1	1	1	1	1
mask-posMask	1	1	1	1	1	1	1

Navigation Default Settings continued

Parameter	SPG 2.xx	SPG 3.xx	ADR 3.xx, ADR 4.xx, UDR 1.xx	FTS 1.xx	TIM 1.0x	TIM 1.1x	HPG 1.xx
mask-timeMask	1	1	1	1	1	1	1
mask-staticHoldMask	1	1	1	1	1	1	1
mask-dgpsMask	1	1	1	1	1	1	1
mask-cnoThreshold	1	1	1	1	1	1	1
mask-utc	1	1	1	1	1	1	1
dynModel	0	0	4	2	2	2	0
fixMode	3	3	3	3	3	3	3
fixedAlt	0	0	0	0	0	0	0
fixedAltVar	1	1	1	1	1	1	1
minElev	5	5	5	5	5	5	10
drLimit	0	0	0	0	0	0	0
pDop	25	25	25	25	25	25	25
tDop	25	25	25	25	25	25	25
pAcc	100	100	100	100	100	100	100
tAcc	300	350	300	300	350	350	350
staticHoldThresh	0	0	0	0	0	0	0
dgpsTimeOut	60	60	60	60	60	60	60
cnoThreshNumSVs	0	0	0	0	0	0	0
cnoThresh	0	0	0	0	0	0	0
staticHoldMaxDist	200	0	200	200	200	0	0
utcStandard	0	0	0	3	3	3	0

B.8 Navigation Settings (UBX-CFG-NAVX5)

For parameter and protocol description see section [UBX-CFG-NAVX5](#).

Navigation Default Settings (SPG/FTS/TIM)

Parameter	SPG 2.xx	SPG 3.0x	SPG 3.5x	FTS 1.xx, TIM 1.0x	TIM 1.1x
mask1-minMax	1	1	1	1	1
mask1-minCno	1	1	1	1	1
mask1-initial3dfix	1	1	1	1	1
mask1-wknRoll	1	1	1	1	1
mask1-ackAid	1	1	1	1	1
mask1-ppp	1	1	1	1	1
mask1-aop	1	1	1	1	1
mask2-adr	0	0	0	0	0
minSVs	3	3	3	1	1
maxSVs	20	32	32	20	32
minCNO	6	6	6	9	9
iniFix3D	0	0	0	0	0
ackAiding	0	0	0	0	0
wknRollover	1756	1867	1936	1756	1867
usePPP	0	0	0	0	0
aopCfg-useAOP	0	0	0	0	0

Navigation Default Settings (SPG/FTS/TIM) continued

Parameter	SPG 2.xx	SPG 3.0x	SPG 3.5x	FTS 1.xx, TIM 1.0x	TIM 1.1x
aopOrbMaxErr	100	100	100	100	100
gnssTofsCfg-tolerance	0	0	0	0	0
gnssTofsCfg-useMeasVarTest	0	0	0	0	0
gnssTofsCfg-aopPreCalEnabled	0	0	0	0	0
gnssTofsCfg-aopPreCalDt	0	0	0	0	0
gnssTofsCfg-aopPreCallnhInt	0	0	0	0	0
useAdr	0	0	0	0	0

Navigation Default Settings (ADR/UDR/HPG)

Parameter	ADR 3.xx	ADR 4.xx	UDR 1.xx	HPG 1.30	HPG 1.40
mask1-minMax	1	1	1	1	1
mask1-minCno	1	1	1	1	1
mask1-initial3dfix	1	1	1	1	1
mask1-wknRoll	1	1	1	1	1
mask1-ackAid	1	1	1	1	1
mask1-ppp	1	1	1	1	1
mask1-aop	1	1	1	1	1
mask2-adr	0	0	0	0	0
minSVs	2	2	2	3	3
maxSVs	20	20	20	20	20
minCNO	6	6	12	6	6
iniFix3D	0	0	0	0	0
ackAiding	0	0	0	0	0
wknRollover	1756	1756	1756	1867	1867
usePPP	0	0	0	1	1
aopCfg-useAOP	0	0	0	0	0
aopOrbMaxErr	100	100	100	100	100
gnssTofsCfg-tolerance	0	0	0	0	0
gnssTofsCfg-useMeasVarTest	0	0	0	0	0
gnssTofsCfg-aopPreCalEnabled	0	0	0	0	0
gnssTofsCfg-aopPreCalDt	0	0	0	0	0
gnssTofsCfg-aopPreCallnhInt	0	0	0	0	0
useAdr	1	1	1	0	0

B.9 NMEA Protocol Settings (UBX-CFG-NMEA)

For parameter and protocol description see section [UBX-CFG-NMEA](#).

NMEA Protocol Default Settings

Parameter	SPG 2.xx, SPG 3.xx, ADR 3.xx, FTS 1.xx, TIM 1.xx, ADR 4.xx, UDR 1.xx, HPG 1.xx
filter-posFilt	0
filter-mskPosFilt	0
filter-timeFilt	0
filter-dateFilt	0
filter-gpsOnlyFilter	0
filter-trackFilt	0

NMEA Protocol Default Settings continued

Parameter	SPG 2.xx, SPG 3.xx, ADR 3.xx, FTS 1.xx, TIM 1.xx, ADR 4.xx, UDR 1.xx, HPG 1.xx
nmeaVersion	0x40
numSV	0
flags-compat	0
flags-consider	1
flags-limit82	0
gnssToFilter-gps	0
gnssToFilter-sbas	0
gnssToFilter-qzss	0
gnssToFilter-glonass	0
gnssToFilter-beidou	0
svNumbering	0
mainTalkerId	0
gsvTalkerId	0
bdsTalkerId	not set

B.10 Odometer Settings (UBX-CFG-ODO)

For parameter and protocol description see section [UBX-CFG-ODO](#).

ODO Default Settings

Parameter	SPG 2.xx, SPG 3.0x, ADR 3.xx, FTS 1.xx, TIM 1.xx, ADR 4.xx, UDR 1.xx, HPG 1.xx	SPG 3.5x
flags-useODO	0	1
flags-useCOG	0	1
flags-outLPVcl	0	1
flags-outLPCog	0	1
odoCfg-profile	0	0
cogMaxSpeed	1	1
cogMaxPosAcc	50	50
vellpGain	153	153
coglpGain	76	76

B.11 Power Management 2 Configuration (UBX-CFG-PM2)

For parameter and protocol description see section [UBX-CFG-PM2](#).

Power Management 2 Configuration Default Settings

Parameter	SPG 2.xx, ADR 3.xx, FTS 1.xx, ADR 4.xx, UDR 1.xx	SPG 3.0x	SPG 3.51	TIM 1.0x	TIM 1.1x
maxStartupStateDur	0	0	0	0	0
flags-extintSel	0	0	0	0	0
flags-extintWake	0	0	0	0	0
flags-extintBackup	0	0	0	0	0
flags-extintInactive	n/a	0	0	n/a	0
flags-limitPeakCurr	0	0	0	0	0
flags-waitTimeFix	0	0	0	1	1
flags-updateRTC	0	0	0	0	0

Power Management 2 Configuration Default Settings continued

Parameter	SPG 2.xx, ADR 3.xx, FTS 1.xx, ADR 4.xx, UDR 1.xx	SPG 3.0x	SPG 3.51	TIM 1.0x	TIM 1.1x
flags-updateEPH	1	1	0	1	1
flags-doNotEnterOff	0	0	1	0	0
flags-mode	1	1	1	1	1
updatePeriod	1000	1000	1000	1000	1000
searchPeriod	10000	10000	10000	10000	10000
gridOffset	0	0	0	0	0
onTime	0	0	0	0	0
minAcqTime	0	0	180	0	0
setPOTstate-enEarlyRfOff	1	1	1	1	1
setPOTstate-minMeasEarlyRfOff	7	7	7	7	7
setPOTstate-enChnEarlyDone	1	1	1	1	1
setPOTstate-minCorrMeasEarlyDone	2	2	1	2	2
setPOTstate-doSetCwSuspFlag	1	1	1	1	1
setPOTstate-doldleChnIfCw	1	1	0	1	1
setPOTstate-numCwSuspForIdle	3	3	0	3	3
setTransCond-minGoodSigPowSaveEnter	6	6	8	6	6
setTransCond-cnoThrPowSafeEnter	20	20	20	20	20
setTransCond-enCheckSigPowSafeStay	0	0	1	0	0
setTransCond-minGoodSigPowSafeStay	0	0	6	0	0
setTransCond-cnoThrPowSafeStay	0	0	18	0	0
genSettings-behavOffState	0	0	0	0	0
genSettings-fixOverdet	1	1	0	1	1
genSettings-badGeom	0	0	0	0	0
genSettings-trickyEnv	0	0	0	0	0
genSettings-maxNbrSVsNoEph	3	3	2	3	3
genSettings-maxTimeUntilFrame	0	0	0	0	0
genSettings-thresDueTime	5	5	5	5	5
extintInactivityMs	n/a	0	0	n/a	0

B.12 Port Configuration (UBX-CFG-PRT)

For parameter and protocol description see section [UBX-CFG-PRT](#).

B.12.1 UART Port Configuration

For parameter and protocol description see section [UBX-CFG-PRT-UART](#).

UART 1 Default Settings

<i>Parameter</i>	<i>SPG 2.xx, SPG 3.xx, FTS 1.xx, TIM 1.xx</i>	<i>ADR 3.xx, ADR 4.xx, UDR 1.xx</i>	<i>HPG 1.xx</i>
txReady-en	0	0	0
txReady-pol	0	0	0
txReady-pin	0	0	0
txReady-thres	0	0	0
baudRate	9600	9600	9600
inProtoMask	inUbx,inNmea,inRtcm	inUbx,inNmea,inRtcm	inUbx,inNmea,inRtcm3
outProtoMask	outUbx,outNmea	outUbx,outNmea	outUbx,outNmea, outRtcm3
flags-extendedTxTimeout	0	0	0

B.12.2 USB Port Configuration

For parameter and protocol description see section [UBX-CFG-PRT-USB](#).

USB Default Settings

<i>Parameter</i>	<i>SPG 2.xx, SPG 3.xx, ADR 3.xx, FTS 1.xx, TIM 1. xx, ADR 4.xx, UDR 1.xx</i>	<i>HPG 1.xx</i>
txReady-en	0	0
txReady-pol	0	0
txReady-pin	0	0
txReady-thres	0	0
inProtoMask	inUbx,inNmea,inRtcm	inUbx,inNmea,inRtcm3
outProtoMask	outUbx,outNmea	outUbx,outNmea,outRtcm3
flags-extendedTxTimeout	0	0

B.12.3 SPI Port Configuration

For parameter and protocol description see section [UBX-CFG-PRT-SPI](#).

SPI Default Settings

<i>Parameter</i>	<i>SPG 2.xx, SPG 3.xx, ADR 3.xx, FTS 1.xx, TIM 1.xx, ADR 4.xx, UDR 1.xx, HPG 1.xx</i>
txReady-en	0
txReady-pol	0
txReady-pin	0
txReady-thres	0
mode-spiMode	0
mode-flowControl	0
mode-ffCnt	0
inProtoMask	None
outProtoMask	None
flags-extendedTxTimeout	0

B.12.4 DDC Port Configuration

For parameter and protocol description see section [UBX-CFG-PRT-DDC](#).

DDC Default Settings

Parameter	SPG 2.xx, SPG 3.xx, ADR 3.xx, FTS 1.xx, TIM 1.xx, ADR 4.xx, UDR 1.xx	HPG 1.xx
txReady-en	0	0
txReady-pol	0	0
txReady-pin	0	0
txReady-thres	0	0
mode-slaveAddr	0x42	0x42
inProtoMask	inUbx,inNmea,inRtcm	inUbx,inNmea,inRtcm3
outProtoMask	outUbx,outNmea	outUbx,outNmea,outRtcm3
flags-extendedTxTimeout	0	0

B.13 Output Rate Settings (UBX-CFG-RATE)

For parameter and protocol description see section [UBX-CFG-RATE](#).

Output Rate Default Settings

Parameter	SPG 2.xx, SPG 3.xx, ADR 3.xx, FTS 1.xx, TIM 1.xx, ADR 4.xx, UDR 1.xx, HPG 1.xx
measRate	1000
navRate	1
timeRef	1

B.14 Remote Inventory Settings (UBX-CFG-RINV)

For parameter and protocol description see section [UBX-CFG-RINV](#).

Remote Inventory Default Settings

Parameter	SPG 2.xx, SPG 3.xx, ADR 3.xx, FTS 1.xx, TIM 1.xx, HPG 1.xx
flags-dump	0
flags-binary	0

B.15 Receiver Manager Configuration Settings (UBX-CFG-RXM)

For parameter and protocol description see section [UBX-CFG-RXM](#).

Power Management Default Settings

Parameter	SPG 2.xx, FTS 1.xx, TIM 1.0x	SPG 3.0x, TIM 1.1x, HPG 1.xx	ADR 3.xx, ADR 4.xx, UDR 1.xx	SPG 3.5x
trkModes-sensMode	8	8	9	9
lpMode	0	0	0	1

B.16 SBAS Configuration Settings (UBX-CFG-SBAS)

For parameter and protocol description see section [UBX-CFG-SBAS](#).

SBAS Configuration Default Settings

Parameter	SPG 2.xx, FTS 1.xx, TIM 1.0x	SPG 3.0x	SPG 3.5x	ADR 3.xx, ADR 4.xx, UDR 1.xx	TIM 1.1x
mode-enabled *	1	1	1	1	0
mode-test	0	0	0	0	0
usage-range	1	1	1	1	1

SBAS Configuration Default Settings continued

Parameter	SPG 2.xx, FTS 1.xx, TIM 1.0x	SPG 3.0x	SPG 3.5x	ADR 3.xx, ADR 4.xx, UDR 1.xx	TIM 1.1x
usage-diffCorr	1	1	1	1	1
usage-integrity	0	0	0	0	0
maxSBAS *	3	3	3	3	3
scanmode2	None	None	None	None	None
scanmode1	120,124,126,129,133,135,137,138	120,123,127,128,129,133,135,136,137,138	120, 123,127-129, 133,135-138	120,124,126,127,128,129,133,135,137,138	120,123,127,128,129,133,135,136,137,138

* These parameters are deprecated; use [UBX-CFG-GNSS](#) instead.

B.17 Timepulse Settings (UBX-CFG-TP5)

For parameter and protocol description see section [UBX-CFG-TP5](#).

TIMEPULSE1 Default Settings

Parameter	SPG 2.xx	SPG 3.xx, HPG 1.xx	ADR 3.xx, ADR 4.xx, UDR 1.xx	FTS 1.xx	TIM 1.xx
antCableDelay	50	50	50	50	50
rfGroupDelay	0	0	0	0	0
freqPeriod	1000000	1000000	0	0	1000000
freqPeriodLock	1000000	1000000	0	0	1000000
pulseLenRatio	0	0	0	0	0
pulseLenRatioLock	100000	100000	0	0	100000
userConfigDelay	0	0	0	0	0
flags-active	1	1	0	1	1
flags-lockGpsFreq	1	n/a	n/a	n/a	n/a
flags-lockGnssFreq	n/a	1	1	1	1
flags-lockedOtherSet	1	1	1	1	1
flags-isFreq	0	0	0	0	0
flags-isLength	1	1	1	1	1
flags-alignToTow	1	1	1	1	1
flags-polarity	1	1	0	0	1
flags-gridUtcGps	0	n/a	n/a	n/a	n/a
flags-gridUtcGnss	n/a	0	0	1	1
flags-syncMode	n/a	0	0	0	0

B.18 USB Settings (UBX-CFG-USB)

For parameter and protocol description see section [UBX-CFG-USB](#).

USB Default Settings

Parameter	SPG 2.xx, ADR 3.xx, FTS 1.xx, TIM 1.0x, ADR 4.xx, UDR 1.xx	SPG 3.xx, TIM 1.1x, HPG 1.xx
vendorID	0x1546	0x1546
productID	0x01A8	0x01A8
powerConsumption	100	100

USB Default Settings continued

<i>Parameter</i>	<i>SPG 2.xx, ADR 3.xx, FTS 1.xx, TIM 1.0x, ADR 4.xx, UDR 1.xx</i>	<i>SPG 3.xx, TIM 1.1x, HPG 1.xx</i>
flags-reEnum	0	0
flags-powerMode	1	1
vendorString	u-blox AG - www.u-blox.com	u-blox AG - www.u-blox.com
productString	u-blox GNSS receiver	u-blox GNSS receiver
serialNumber	not set	not set

Related Documents

Overview

As part of our commitment to customer support, u-blox maintains an extensive volume of technical documentation for our products. In addition to product-specific data sheets and integration manuals, general documents are also available. These include:

- GPS Compendium, Docu. No [GPS-X-02007](#)
- GPS Antennas - RF Design Considerations for u-blox GPS Receivers, Docu. No [GPS-X-08014](#)

Our website www.u-blox.com is a valuable resource for general and product specific documentation.

For design and integration projects the Receiver Description Including Protocol Specification should be used together with the Data Sheet and Hardware Integration Manual of the GNSS receiver.

Revision History

<i>Revision</i>	<i>Date</i>	<i>Name</i>	<i>Status / Comments</i>
R01	30-Sep-2013	efav	Added u-blox M8 firmware 2.00
R02	01-Nov-2013	efav	Added u-blox M8 firmware 2.01
R03	15-Dec-2013	efav	Added u-blox M8 ADR product variant
R04	10-Feb-2014	efav	Added u-blox M8 Time & Frequency Sync product variant
R05	27-Jun-2014	efav	Added u-blox M8 Timing product variant
R06	09-Sep-2014	mfre	Minor corrections
R07	09-Sep-2014	mfre	Added u-blox M8 firmware 2.30
R08	19-Nov-2014	mfre	Added u-blox M8 L-type modules product variant
R09	30-Nov-2015	mfre	Added u-blox 8 / u-blox M8 SPG 3.01 firmware
R10	15-Feb-2016	mfre	Added u-blox 8 / u-blox M8 TIM 1.10 firmware
R11	04-May-2016	mfre	Added u-blox 8 / u-blox M8 ADR 4.00 and UDR 1.00 firmware
R12	28-Apr-2017	jhak	Added u-blox 8 / u-blox M8 ADR 4.10, HPG 1.40 and SPG 3.51 firmware

Contact

For complete contact information visit us at www.u-blox.com

u-blox Offices

North, Central and South America

u-blox America, Inc.

Phone: +1 703 483 3180
E-mail: info_us@u-blox.com

Regional Office West Coast:

Phone: +1 408 573 3640
E-mail: info_us@u-blox.com

Technical Support:

Phone: +1 703 483 3185
E-mail: support_us@u-blox.com

Headquarters

Europe, Middle East, Africa

u-blox AG

Phone: +41 44 722 74 44
E-mail: info@u-blox.com
Support: support@u-blox.com

Asia, Australia, Pacific

u-blox Singapore Pte. Ltd.

Phone: +65 6734 3811
E-mail: info_ap@u-blox.com
Support: support_ap@u-blox.com

Regional Office Australia:

Phone: +61 2 8448 2016
E-mail: info_au@u-blox.com
Support: support_ap@u-blox.com

Regional Office China (Beijing):

Phone: +86 10 68 133 545
E-mail: info_cn@u-blox.com
Support: support_cn@u-blox.com

Regional Office China (Chongqing):

Phone: +86 23 6815 1588
E-mail: info_cn@u-blox.com
Support: support_cn@u-blox.com

Regional Office China (Shanghai):

Phone: +86 21 6090 4832
E-mail: info_cn@u-blox.com
Support: support_cn@u-blox.com

Regional Office China (Shenzhen):

Phone: +86 755 8627 1083
E-mail: info_cn@u-blox.com
Support: support_cn@u-blox.com

Regional Office India:

Phone: +91 80 4050 9200
E-mail: info_in@u-blox.com
Support: support_in@u-blox.com

Regional Office Japan (Osaka):

Phone: +81 6 6941 3660
E-mail: info_jp@u-blox.com
Support: support_jp@u-blox.com

Regional Office Japan (Tokyo):

Phone: +81 3 5775 3850
E-mail: info_jp@u-blox.com
Support: support_jp@u-blox.com

Regional Office Korea:

Phone: +82 2 542 0861
E-mail: info_kr@u-blox.com
Support: support_kr@u-blox.com

Regional Office Taiwan:

Phone: +886 2 2657 1090
E-mail: info_tw@u-blox.com
Support: support_tw@u-blox.com