

PCB header - MCV 1,5/ 3-GF-3,5 - 1843237

Please be informed that the data shown in this PDF Document is generated from our Online Catalog. Please find the complete data in the user's documentation. Our General Terms of Use for Downloads are valid (<http://phoenixcontact.com/download>)

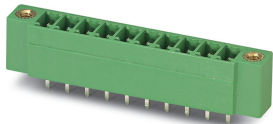

The figure shows a 10-position version of the product

PCB headers, nominal cross section: 1.5 mm², color: green, nominal current: 8 A, rated voltage (III/2): 160 V, contact surface: Tin, type of contact: Male connector, number of potentials: 3, Number of rows: 1, Number of positions per row: 3, number of connections: 3, product range: MCV 1,5/..-GF, pitch: 3.5 mm, mounting: Wave soldering, pin layout: Linear pinning, solder pin [P]: 3.4 mm, plug-in system: MINI COMBICON, Pin connector pattern alignment: Standard, Locking: Screw locking, mounting: Threaded flange, type of packaging: packed in cardboard

Your advantages

- ✓ Well-known mounting principle allows worldwide use
- ✓ Screwable flange for superior mechanical stability
- ✓ Vertical connection enables multi-row arrangement on the PCB
- ✓ Maximum flexibility when it comes to device design – one header for connectors with different connection technologies

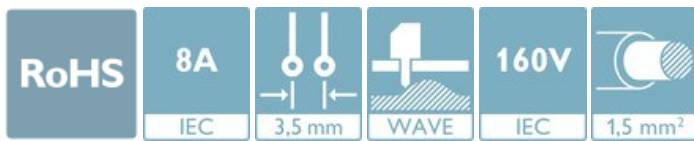

Key Commercial Data

Packing unit	1 pc
Minimum order quantity	250 pc
GTIN	 4 017918 112424
GTIN	4017918112424
Weight per Piece (excluding packing)	2.020 g
Custom tariff number	85366930
Country of origin	Germany

Technical data

Item properties

Brief article description	PCB header
Connector system	MINI COMBICON
Type of contact	Male connector

PCB header - MCV 1,5/ 3-GF-3,5 - 1843237

Technical data

Item properties

Range of articles	MCV 1,5/...-GF
Pitch	3.5 mm
Number of positions	3
Mounting type	Wave soldering
Pin layout	Linear pinning
Locking	Threaded flange
Number of rows	1
Number of connections	3
Number of potentials	3
Pin connector pattern alignment	Standard

Electrical parameters

Nominal current	8 A
Nom. voltage	160 V
Rated voltage (III/3)	160 V
Rated voltage (III/2)	160 V
Rated voltage (II/2)	250 V
Rated surge voltage (III/3)	2.5 kV
Rated surge voltage (III/2)	2.5 kV
Rated surge voltage (II/2)	2.5 kV

Material data - contact

Note	WEEE/RoHS-compliant, free of whiskers according to IEC 60068-2-82/ JEDEC JESD 201
Contact material	Cu alloy
Surface characteristics	Tin-plated
Metal surface contact area (top layer)	Tin (3 - 5 µm Sn)
Metal surface contact area (middle layer)	Nickel (1 - 3 µm Ni)
Metal surface soldering area (top layer)	Tin (3 - 5 µm Sn)
Metal surface soldering area (middle layer)	Nickel (1 - 3 µm Ni)

Material data - housing

Housing color	green (6021)
Insulating material	PBT
Insulating material group	IIIa
CTI according to IEC 60112	225
Flammability rating according to UL 94	V0

Flange specifications

Type of locking	Screw locking
-----------------	---------------

PCB header - MCV 1,5/ 3-GF-3,5 - 1843237

Technical data

Flange specifications

Mounting flange	Threaded flange
Torque	0.3 Nm

Dimensions for the product

Caption	Schematische Abbildung - weitere Details siehe Produktfamilienzeichnung im Download Center
Length [l]	7.25 mm
Width [w]	20.8 mm
Height [h]	12.6 mm
Pitch	3.5 mm
Height (without solder pin)	9.2 mm
Solder pin [P]	3.4 mm
Pin dimensions	0.8 x 0.8 mm

Dimensions for PCB design

Hole diameter	1.2 mm
---------------	--------

Packaging information

Type of packaging	packed in cardboard
Pieces per package	250
Denomination packing units	Pcs.

Ambient conditions

Ambient temperature (storage/transport)	-40 °C ... 70 °C
Ambient temperature (assembly)	-5 °C ... 100 °C
Ambient temperature (operation)	-40 °C ... 100 °C (dependent on the derating curve)

Air clearances and creepage distances

Clearances and creepage distances	IEC 60664-1:2007-04
Specification	IEC 60664-1:2007-04
Minimum clearance - inhomogeneous field (III/3)	1.5 mm
Minimum clearance - inhomogeneous field (III/2)	1.5 mm
Minimum clearance - inhomogeneous field (II/2)	1.5 mm
Minimum creepage distance value (III/3)	2.5 mm
Minimum creepage distance value (III/2)	1.6 mm
Minimum creepage distance value (II/2)	2.5 mm

Standards and Regulations

Connection in acc. with standard	EN-VDE
	CSA
Flammability rating according to UL 94	V0

PCB header - MCV 1,5/ 3-GF-3,5 - 1843237

Technical data

Environmental Product Compliance

China RoHS	Environmentally Friendly Use Period = 50 years
	For details about hazardous substances go to tab "Downloads", Category "Manufacturer's declaration"

Drawings

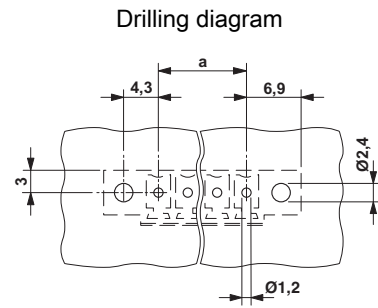
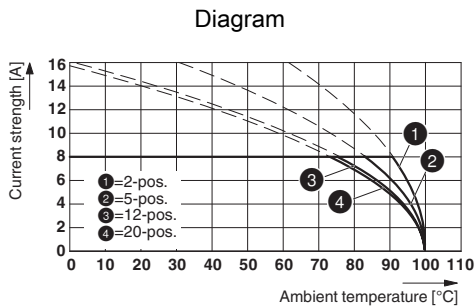

Type: MC 1,5/...-STF-3,5 with MCV 1,5/...-GF-3,5

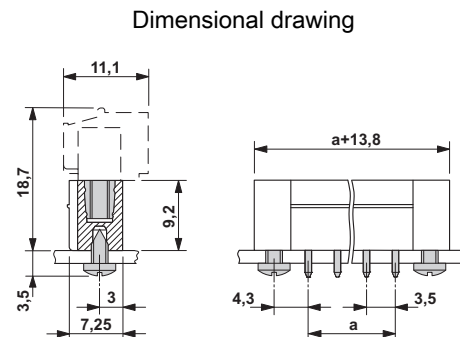
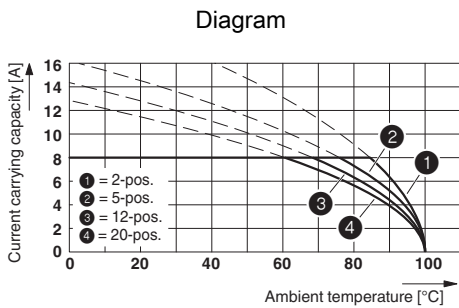

Classifications

eCl@ss

eCl@ss 10.0.1	27440402
eCl@ss 11.0	27460201
eCl@ss 4.0	27260700
eCl@ss 4.1	27260700
eCl@ss 5.0	27260700
eCl@ss 5.1	27260700
eCl@ss 6.0	27260700
eCl@ss 7.0	27440402
eCl@ss 9.0	27440402

PCB header - MCV 1,5/ 3-GF-3,5 - 1843237

Classifications

ETIM

ETIM 3.0	EC001121
ETIM 4.0	EC002637
ETIM 6.0	EC002637
ETIM 7.0	EC002637

UNSPSC

UNSPSC 6.01	30211810
UNSPSC 7.0901	39121409
UNSPSC 11	39121409
UNSPSC 12.01	39121409
UNSPSC 13.2	39121409
UNSPSC 18.0	39121409
UNSPSC 19.0	39121409
UNSPSC 20.0	39121409
UNSPSC 21.0	39121409

Approvals

Approvals

Approvals

VDE Gutachten mit Fertigungsüberwachung / CSA / IEC CB Scheme / EAC / cULus Recognized

Ex Approvals

Approval details

VDE Gutachten mit Fertigungsüberwachung		http://www2.vde.com/de/Institut/Online-Service/VDE-gepruefteProdukte/Seiten/Online-Suche.aspx	40011723
Nominal voltage UN	160 V		
Nominal current IN	8 A		

PCB header - MCV 1,5/ 3-GF-3,5 - 1843237

Approvals

CSA		http://www.csagroup.org/services-industries/product-listing/	13631
	B		D
Nominal voltage UN	300 V		300 V
Nominal current IN	8 A		8 A

IECEE CB Scheme		http://www.iecee.org/	DE1-60987-B1B2
Nominal voltage UN		160 V	
Nominal current IN		8 A	

EAC			B.01687
-----	--	--	---------

cULus Recognized		http://database.ul.com/cgi-bin/XYV/template/LISEXT/1FRAME/index.htm	E60425-20110128
	B		D
Nominal voltage UN	300 V		300 V
Nominal current IN	8 A		8 A

Accessories

Accessories

Coding element

Coding profile - CP-MSTB - 1734634

Coding profile, is inserted into the slot on the plug or inverted header, red insulating material



Labeled terminal marker

PCB header - MCV 1,5/ 3-GF-3,5 - 1843237

Accessories

Marker card - SK 3,5/2,8:FORTL.ZAHLEN - 0804073



Marker card, Card, white, labeled, horizontal: consecutive numbers 1 ... 10, 11 ... 20, etc. up to 91 ... 99, mounting type: adhesive, for terminal block width: 3.5 mm, lettering field size: 3.5 x 2.8 mm

Additional products

Printed-circuit board connector - TFMC 1,5/ 3-STF-3,5 - 1772715



PCB connector, nominal cross section: 1.5 mm², color: green, nominal current: 8 A, rated voltage (III/2): 160 V, contact surface: Tin, type of contact: Female connector, number of potentials: 3, Number of rows: 1, Number of positions per row: 3, number of connections: 6, product range: TFMC 1,5/...-STF, pitch: 3.5 mm, connection method: Push-in spring connection, conductor/PCB connection direction: 0 °, plug-in system: MINI COMBICON, Locking: Screw locking, mounting: Screw flange, type of packaging: packed in cardboard

Printed-circuit board connector - MC 1,5/ 3-STF-3,5 - 1847068



PCB connector, nominal cross section: 1.5 mm², color: green, nominal current: 8 A, rated voltage (III/2): 160 V, contact surface: Tin, type of contact: Female connector, number of potentials: 3, Number of rows: 1, Number of positions per row: 3, number of connections: 3, product range: MC 1,5/...-STF, pitch: 3.5 mm, connection method: Screw connection with tension sleeve, screw head form: L Slotted, conductor/PCB connection direction: 0 °, plug-in system: MINI COMBICON, Locking: Screw locking, mounting: Screw flange, type of packaging: packed in cardboard

Printed-circuit board connector - MCVW 1,5/ 3-STF-3,5 - 1863013



PCB connector, nominal cross section: 1.5 mm², color: green, nominal current: 8 A, rated voltage (III/2): 160 V, contact surface: Tin, type of contact: Female connector, number of potentials: 3, Number of rows: 1, Number of positions per row: 3, number of connections: 3, product range: MCVW 1,5/...-STF, pitch: 3.5 mm, connection method: Screw connection with tension sleeve, screw head form: L Slotted, conductor/PCB connection direction: -90 °, plug-in system: MINI COMBICON, Locking: Screw locking, mounting: Screw flange, type of packaging: packed in cardboard

Printed-circuit board connector - MCVR 1,5/ 3-STF-3,5 - 1863314



PCB connector, nominal cross section: 1.5 mm², color: green, nominal current: 8 A, rated voltage (III/2): 160 V, contact surface: Tin, type of contact: Female connector, number of potentials: 3, Number of rows: 1, Number of positions per row: 3, number of connections: 3, product range: MCVR 1,5/...-STF, pitch: 3.5 mm, connection method: Screw connection with tension sleeve, screw head form: L Slotted, conductor/PCB connection direction: 90 °, plug-in system: MINI COMBICON, Locking: Screw locking, mounting: Screw flange, type of packaging: packed in cardboard

PCB header - MCV 1,5/ 3-GF-3,5 - 1843237

Accessories

Printed-circuit board connector - FK-MCP 1,5/ 3-STF-3,5 - 1940101



PCB connector, nominal cross section: 1.5 mm², color: green, nominal current: 8 A, rated voltage (III/2): 160 V, contact surface: Tin, type of contact: Female connector, number of potentials: 3, Number of rows: 1, Number of positions per row: 3, number of connections: 3, product range: FK-MCP 1,5/..-STF, pitch: 3.5 mm, connection method: Push-in spring connection, conductor/PCB connection direction: 0 °, plug-in system: MINI COMBICON, Locking: Screw locking, mounting: Screw flange, type of packaging: packed in cardboard

Printed-circuit board connector - FMC 1,5/ 3-STF-3,5 - 1966101



PCB connector, nominal cross section: 1.5 mm², color: green, nominal current: 8 A, rated voltage (III/2): 160 V, contact surface: Tin, type of contact: Female connector, number of potentials: 3, Number of rows: 1, Number of positions per row: 3, number of connections: 3, product range: FMC 1,5/..-STF, pitch: 3.5 mm, connection method: Push-in spring connection, conductor/PCB connection direction: 0 °, plug-in system: MINI COMBICON, Locking: Screw locking, mounting: Screw flange, type of packaging: packed in cardboard