

FEATURES

- For super-high speed switching circuit.
- For small current rectification.
- Allowing to rectify under($I_{F(AV)}=200mA$) condition.
- Allowing high-density mounting.

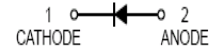

Lead-free



APPLICATIONS

- Schottky epitaxial planar.



SOD-323

ORDERING INFORMATION

Type No.	Marking	Package Code
KMA729-7-F	2B	SOD-323

MAXIMUM RATING @ Ta=25°C unless otherwise specified

Parameter	Symbol	Limits	Unit
DC reverse voltage	V_R	30	V
Repetitive peak reverse voltage	V_{RRM}	30	V
Peak forward Current	I_{FM}	300	mA
Average forward Current	$I_{F(AV)}$	200	mA
Non-repetitive peak forward Surge Current	I_{FSM}	1000	mA
Power Dissipation	P_d	200	mW
Thermal resistance, junction to ambient air	$R_{\theta JA}$	635	°C/W
Junction temperature	T_j	150	°C
Storage temperature range	T_{stg}	-55-150	°C

ELECTRICAL CHARACTERISTICS @ Ta=25°C unless otherwise specified

Parameter	Symbol	Conditions	Min.	Typ.	Max.	Unit
Reverse Breakdown Voltage	$V_{(BR)R}$	$I_R=10\mu A$	30			V
Forward voltage	V_F	$I_F=200mA$			0.55	V
Reverse leakage current	I_R	$V_R=30V$			50	μA
Reverse recovery time	t_{rr}	$I_F=I_R=100mA$, $I_{rr}=10mA, R_L=100\Omega$		3.0		ns
Total capacitance	C_T	$V_R=0V, f=1.0MHz$		30		pF

TYPICAL CHARACTERISTICS @ $T_a=25^\circ C$ unless otherwise specified

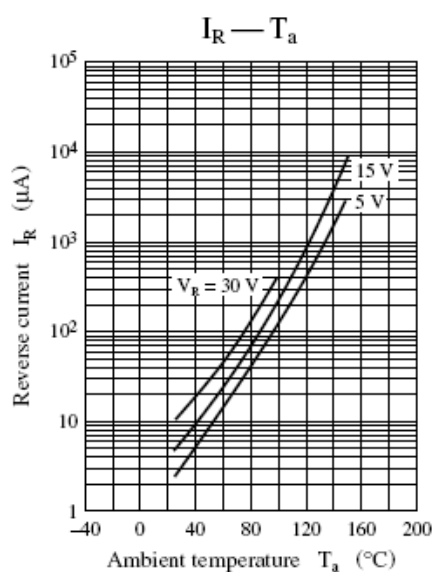
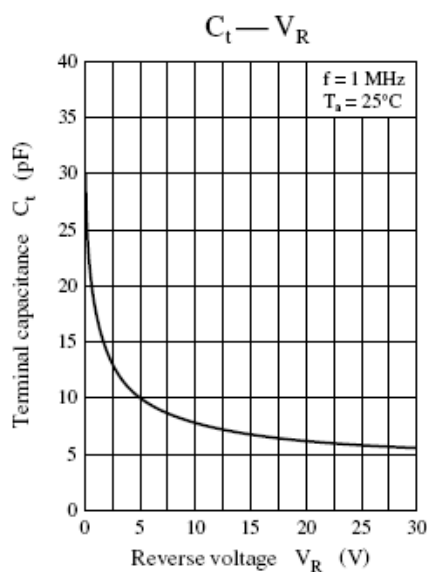
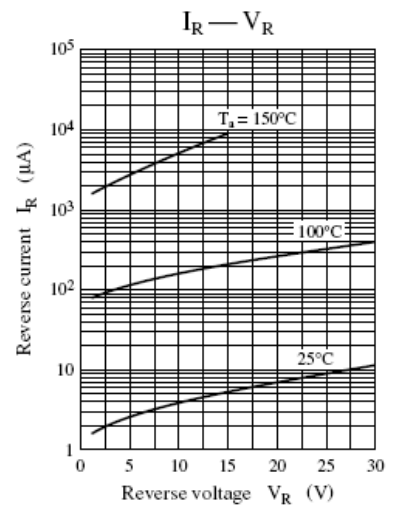
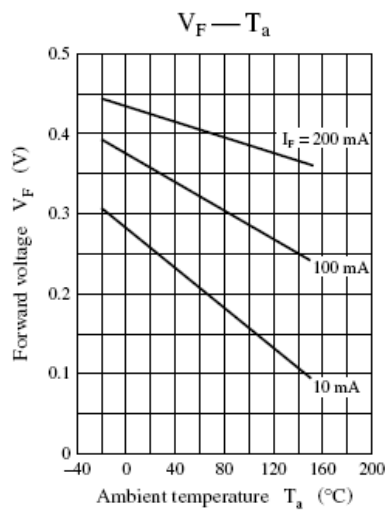
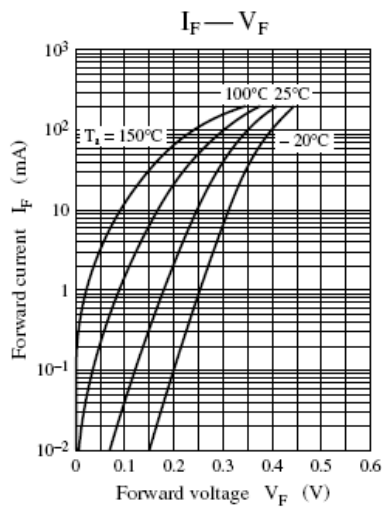

Plastic surface mounted package

SOD-323

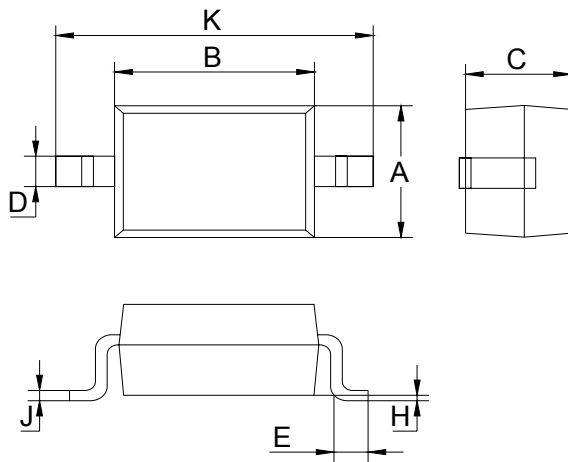

SOD-323		
Dim	Min	Max
A	1.275	1.325
B	1.675	1.725
C	0.9 Typical	
D	0.25	0.35
E	0.27	0.37
H	0.02	0.1
J	0.1 Typical	
K	2.6	2.7
All Dimensions in mm		

SOLDERING FOOTPRINT

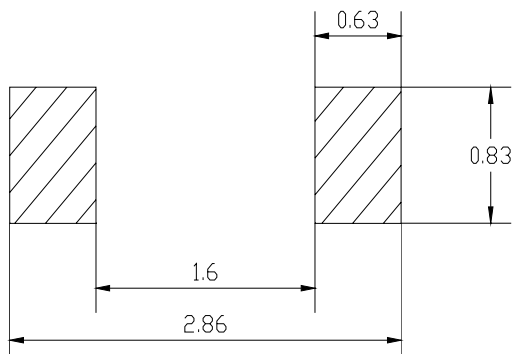

Unit : mm