



Amphenol[®] RF

Automotive Solutions

Global Locations

NORTH AMERICA

United States HQ

4 Old Newtown Road
Danbury, CT 06810

United States

5069 Maureen Lane, Suite B
Moorpark, CA 93021

Mexico

Circunvalacion del Mar 56
Parque Industrial de Nogales
Nogales, Sonora, C.P. 84094

ASIA

China

Block DM2
Tang Wei Industrial District
Gong Ming Street
Guang Ming New District
Shenzhen City, Guangdong
Province, P.R. China

China

No. 55, Industry 2nd Road
Aerospace Economic Technology
Development Zone
Xi'an, Shaanxi Province, P.R. China

India

Plot 3/4B & 5A, CMDA's Industrial
Area
Maraimalai Nagar
Kilkarana Village
Chengleput Taluk, Kancheepuram,
Chennai, 603209

EUROPE

The Netherlands

P.O. Box 63, 3990 DB Houten
Hoofdveste 19
3992 DH Houten

Table of Contents

Company Overview	4
Technologies Supported.....	6
FAKRA Generations.....	8
FAKRA/USCAR Specifications	9
FAKRA/USCAR Mechanical Coding.....	10
FAKRA Interface Drawings	12
FAKRA Connector Ordering Information	14
FAKRA Cable Connectors	15
Generation 4.0	15-16
Generation 3.0.....	17
Generation 2.5 and 2.0	18
Generation 1.0.....	19
Sealed FAKRA	20-21
6.0 GHz FAKRA	21
FAKRA Adapters.....	22
FAKRA PCB Connectors.....	23-28
HSD Cable Assembly Ordering Information	29
HSD Mechanical Coding	30
HSD Cable Assemblies.....	31
HSD Cable Connectors	31-32
HSD PCB Connectors	33
Index.....	34

Amphenol Corporate Overview

Amphenol Corporate Overview

Amphenol Corporation (NYSE ticker: APH) is one of the largest manufacturers of interconnect products in the world. The Company designs, manufactures and markets electrical, electronic and fiber optic connectors, coaxial and flat-ribbon cable, and interconnect systems. Amphenol has a diversified presence as a leader in high growth segments of the interconnect market including: Military and Commercial Aerospace, Automotive, Broadband Communication, Industrial, Information Technology and Data Communications Equipment, Mobile Devices and Wireless Infrastructure.

Amphenol RF Division

Amphenol RF is the world's largest manufacturer of coaxial connectors for use in radio frequency, microwave, and data transmission system applications. Amphenol RF offers a complete range of RF connectors, cable assemblies and components used in the Automotive, Broadband, Wireless LAN/RFID, Wireless Infrastructure, Military Aerospace and Instrumentation markets.

Commitment to Quality

For over 80 years, leading manufacturers of communications, consumer, industrial, automotive, military and aerospace products have relied on Amphenol to provide total interconnect solutions. Maintaining this high level of customer trust requires a total concern for complete customer satisfaction at all levels – from engineering to manufacturing to quality assurance. Since many products are custom designed to individual customer specifications, often for the harshest environments, it's critical that a teamwork approach be taken, involving the customer at all levels. Amphenol RF's commitment to quality remains exceptionally uniform and internationally standardized, from raw materials testing, through design engineering, to automated manufacturing and sub-assembly, to fully documented and traceable test procedures developed in accordance with customer specifications.

Environmental Compliance

Amphenol RF is proud to be a continued world leader in improving environmental issues in the global marketplace. We are committed to meeting and exceeding the ever changing expanse of environmental compliance requirements. Amphenol works diligently with our customers on a variety of environmental protocols. As a global supplier we are committed to supporting RoHS/202/95/EC, PFOS 2006/12/EC, and REACH requirements.

Automotive Solutions

As telematics advancements become more reliable, available and inexpensive, vehicles are transforming into an intelligent platform for enabling mobile life. With these recent advancements in communications, technology, and increased consumer demand for a diverse array of on-board telematics services, RF communications systems have become integral components of today's automobile, trucking, watercraft, motorcycle, and off-road construction markets.

Utilizing a modified metal SMB connector embedded within a plastic housing, which is designed with multiple color codes for easy identification, FAKRA connectors are designed to perform up to 6 GHz and meet the particular mechanical and environmental requirements of the automotive industry. Amphenol RF also offers a variety of connectors for board-to-board, PCB interfaces, and traditional antenna interfaces.

Technologies Supported

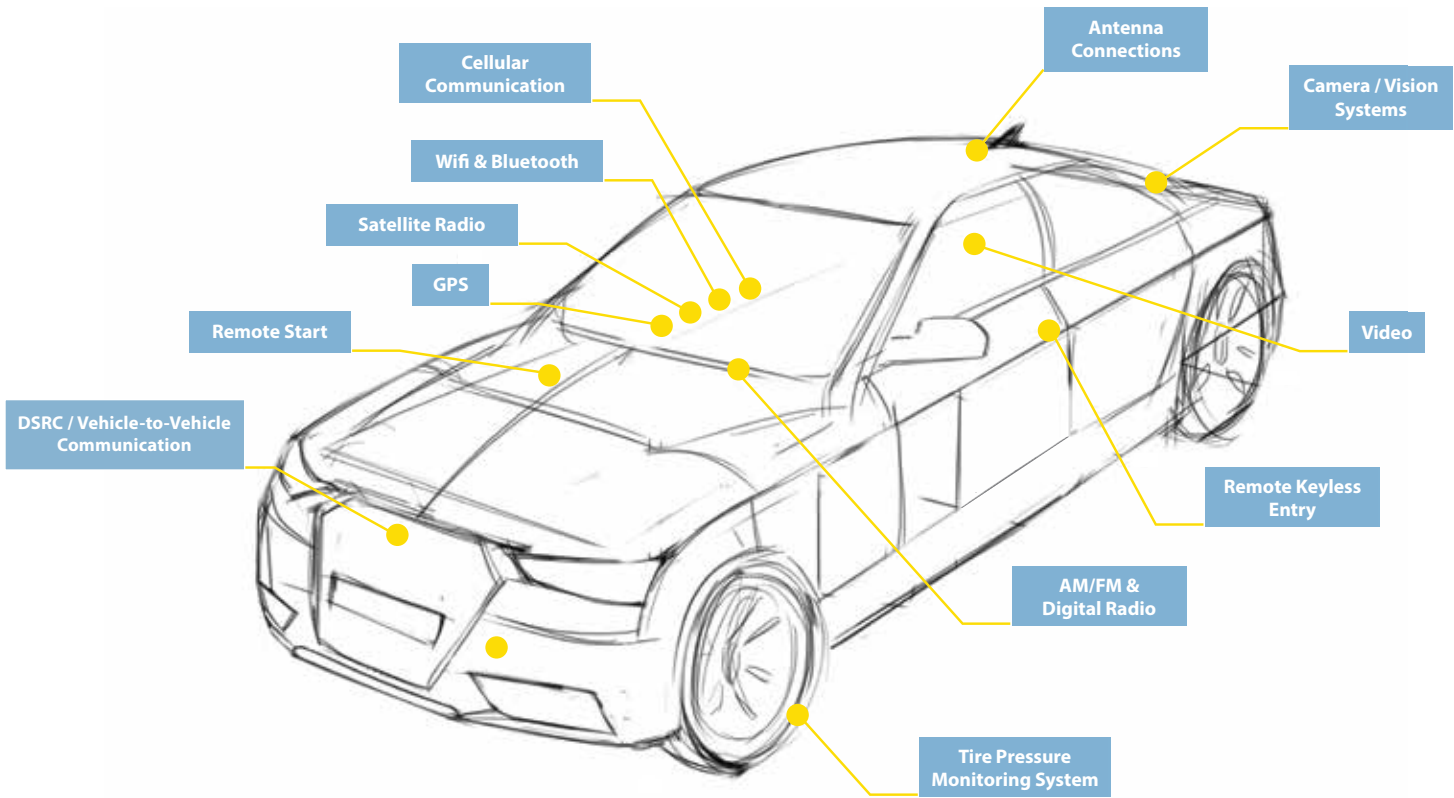

AM/FM Radio

Antenna technology that supports GPS and Satellite Radio is the same antenna that will support AM/FM radio. This combined antenna capability not only reduces the number of external antennas on the vehicles, but offers standardization among all of the interconnecting components.

Bluetooth

A short-range radio technology aimed at simplifying communications among Internet devices, between devices and the Internet. It also aims to simplify data synchronization between Internet devices and other computers.

Cameras

HSD connectors support LVDS technology for backup cameras, while FAKRA connectors are an excellent choice for LVDS over coax signals, which are used in next generation digital cameras for external surround and interior cabin monitoring vehicle systems.

Cellular/PCS (Personal Communications Service)

The U.S. Federal Communications Commission (FCC) term used to describe a set of digital cellular technologies being deployed in the U.S. It is also referred to as digital cellular.

DSRC (Dedicated Short Range Communication)

Our FAKRA connectors may be used to support DSRC, or Dedicated Short Range Communication technology. DSRC is a two-way short-to-medium-range wireless communications capability that permits very high data transmission critical in communications-based active safety applications.

GPS (Global Positioning System)

Our FAKRA connectors are used to carry signals from external GPS antennas to interior vehicle systems, which provide navigation assistance and also allow first responders to precisely locate the vehicle in emergency situations.

GVIF (Gigabit Video Interface)

Our FAKRA and HSD connectors can be used to support GVIF, or Gigabit Video Interface. GVIF is a digital video serial interface developed for high quality uncompressed video transmission from digital video hardware, and is used primarily in automotive applications. It is compatible with the HDCP encryption system. GVIF transmits uncompressed serial data at speeds up to 1.95 gigabits/second.

LVDS (Low Voltage Differential Signaling)

Our FAKRA connectors can be used to support LVDS, or Low Voltage Differential Signaling. Also known as TIA/EIA-644, LVDS is a technical standard that specifies electrical characteristics of a differential, serial communications protocol. LVDS operates at low power and can run at very high speeds.

Satellite Radio

Amphenol RF coaxial connection systems have been an integral part of the signal reception process since the first vehicle broadcast satellites came online. Our connectors conduct the signal from the antenna through the vehicle and into the specific decoder modules.

Vehicle Controls

Adaptive Cruise Control and Collision Avoidance Systems are evolving technologies that utilize FAKRA connectors.

Wi-Fi

Many new automotive models are incorporating Wi-Fi in to their Infotainment offerings. Our FAKRA connectors support this emerging technology.

Wireless Remote

Remote starting, remote keyless entry, and door/window controls are all supported by our FAKRA products.

FAKRA GENERATIONS

		Design Features	Tooling	Production	Compliance	Packaging
	GEN 1.0	Machined Body Machined Contact Unassembled Housing	Hand Tooling	Low Volume	USCAR-17 USCAR-18 DIN 72594-1	Tray Pack Bulk Components
	GEN 2.0	Die Cast Body Singulated Stamped or Machined Contact Pre-Assembled Housing	Hand Tooling	Low Volume	USCAR-17 USCAR-18 DIN 72594-1	Tray Pack Bulk Components
	GEN 2.5	Die Cast Body Stamped Contact Pre-Assembled Housing	Automated Tooling Semi-Automated Tooling	High Volume	USCAR-17 USCAR-18 DIN 72594-1	Tray Pack Contacts sold separately on tape and reel
	GEN 3.0	Die Cast Body Stamped Contact Pre-Assembled Housing	Automated Tooling Semi-Automated Tooling	High Volume	USCAR-17 USCAR-18 DIN 72594-1	Tray Pack Contacts sold separately on tape and reel
	GEN 4.0	Stamped Body Stamped Contact Stamped Sleeve Unassembled Housing	Fully Automated Tooling	High Volume	USCAR-17 USCAR-18 DIN 72594-1 6Q0.90.961D 6Q0.90.961E	Tray Pack for Housing Other components sold on tape and reel



Utilizing world class engineering and manufacturing capabilities, Amphenol RF is well positioned to be the industry leader in all future automotive technologies for years to come.

FAKRA / USCAR PRODUCT SPECIFICATIONS

ELECTRICAL

Impedance	50 Ω Nominal		
Frequency Range	DC-6 GHz		
Performance Specifications:			
VSWR	DC-2 GHz	2 GHz - 3 GHz	3 GHz - 6 GHz*
	<i>Spec Requirement</i> 1.40 max	1.50 max	1.60 max
Insertion Loss	DC - 3GHz	3 GHz - 6 GHz*	
	<i>Spec Requirement</i> ≤ 0.3 dB max	0.45 ≤ dB max	
Insulation Resistance	1000 MΩ min		
Contact Resistance	<i>Center Contact</i>	< 24 MΩ	
	<i>Outer Contact</i>	< 5 MΩ	
Dielectric Withstanding Voltage	<i>At Sea Level</i>	> 800 VRMS (interface only; may be cable limited)	

* Applicable to any 6.0 GHz FAKRA connectors listed in this catalog

MECHANICAL

Durability (Mating Cycles)	100 min
Plastic Housing - Engagement Force	≤ 40 N (Single FAKRA)
Plastic Housing - Disengagement Force	≥ 35 N (Single FAKRA)
Cable Retention Force	> 110 N
Coding	14 mechanical and colored codings
Interface	USCAR-18, DIN

ENVIRONMENTAL

Temperature Range	<i>Operating</i> -40/ +105 C
Thermal Shock	USCAR-2, para 5.6.1
Vibration	USCAR-2, para 5.4.6
Shock	USCAR-2, para 5.4.6

MATERIALS

Plastic Housing	<i>Jacks</i>	Nylon, PBT or PPE
	<i>In-Line Plugs</i>	Nylon or PBT
	<i>PCB Plugs</i>	Nylon
Secondary Locking Clip (if applicable)		PBT
Center Contact	<i>Jack</i>	Beryllium Copper or Phosphor Bronze
	<i>Plug</i>	Brass or Phosphor Bronze
Body		Brass, Zinc Alloy or Phosphor Bronze
Retainer Ring (if applicable)		Beryllium Copper
Ferrule		Copper Alloy
Insulator		TFE or TPX

PLATING

Center Contact		Gold
Body	<i>Cable Mount Connectors</i>	Nickel, Tin
	<i>PCB Mount Connectors</i>	Nickel, Gold, Tin
Ferrule		Nickel

FAKRA/USCAR MECHANICAL CODING

	Jack	Plug	RAL	Color	Application
A			9005	 Jet Black	DAB/AM-FM
B			9001	 Cream	DAB with Power / AM-FM
C			5005	 Signal Blue	GPS
D			4004	 Claret Violet	Cellular Phone
E			6002	 Leaf Green	TV / SDARS Terrestrial
F			8011	 Nut Brown	TV / SDARS Terrestrial / Camera
G			7031	 Blue Grey	SDARS Terrestrial
H			4003	 Heather Violet	GPS Navigation
I			1001	 Beige	Bluetooth / VPM
K			1027	 Curry	SDARS Satellite AM-FM
L			3002	 Carmine Red	VPM
M			2003	 Pastel Orange	RKE / TPMS
N			6019	 Pastel Green	DSRC / VPM
Z			5021	 Water Blue	Universal (Neutral) Code

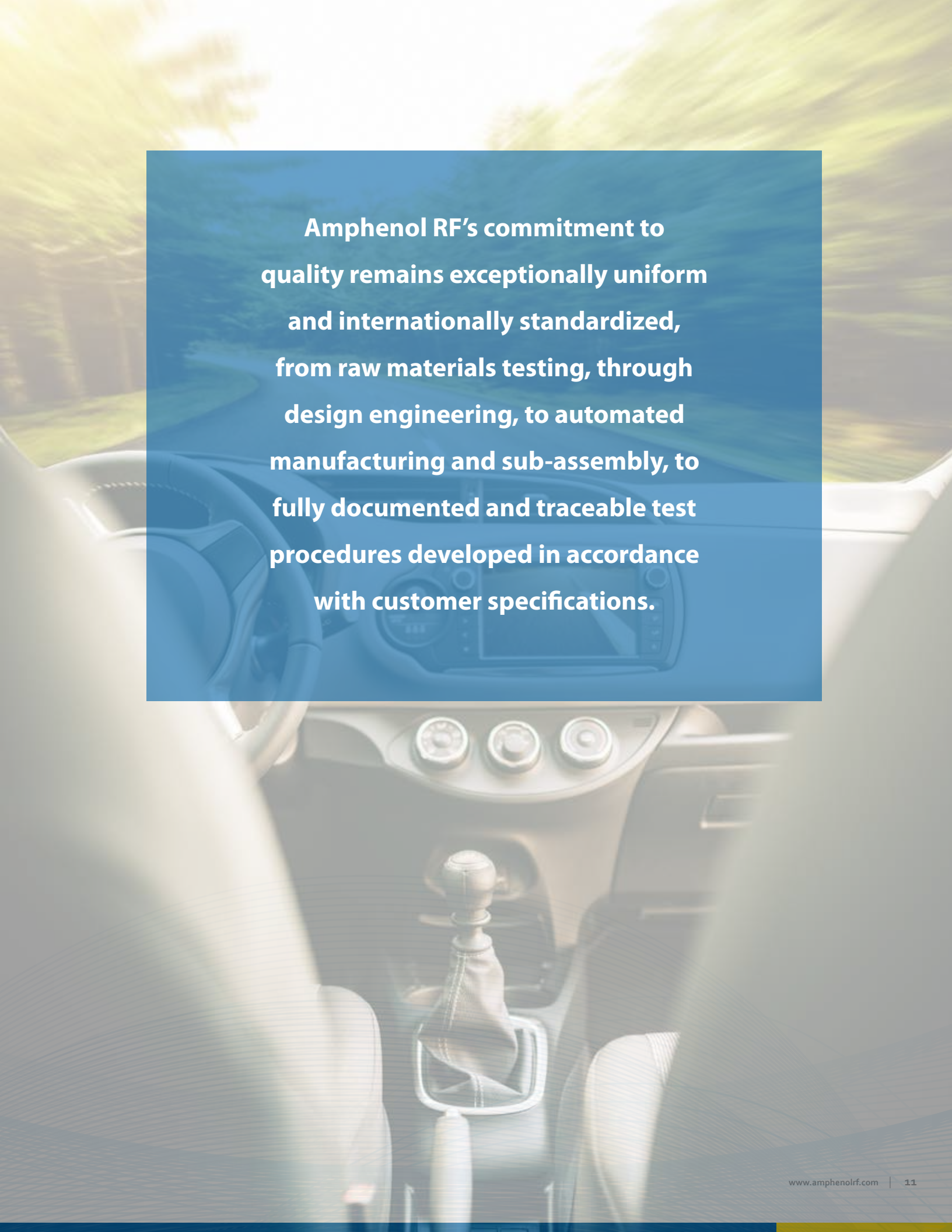

Amphenol RF's commitment to quality remains exceptionally uniform and internationally standardized, from raw materials testing, through design engineering, to automated manufacturing and sub-assembly, to fully documented and traceable test procedures developed in accordance with customer specifications.

INTERFACE DRAWINGS

FAKRA Jack Interface

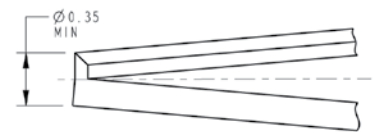
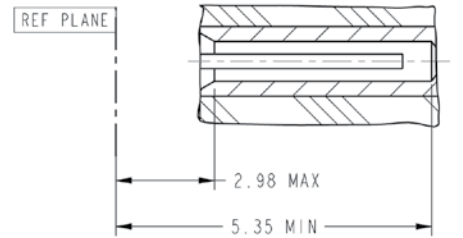
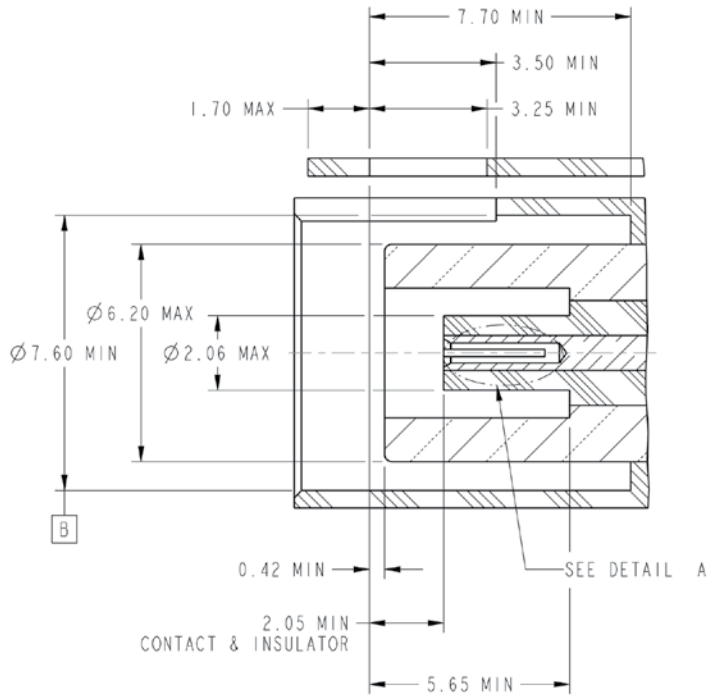

DETAIL A

FAKRA Plug Interface

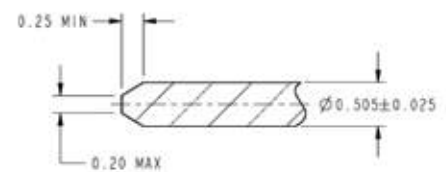
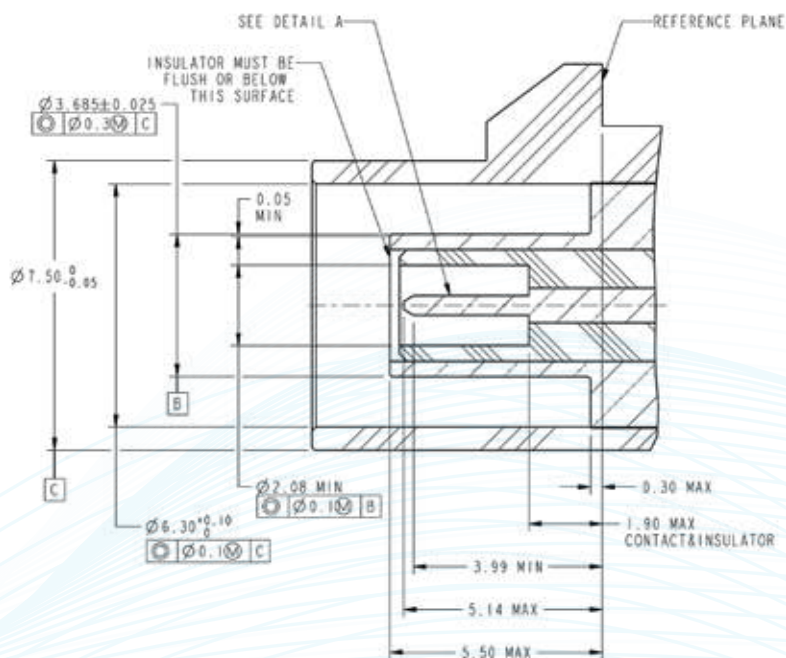

DETAIL A

FAKRA ORDERING INFORMATION

2 F A 1 - N X S P - C O 1 W 0

Generation:

FA Gen 1.0
 2FA Gen 2.0 or 2.5
 3FA Gen 3.0
 4FA Gen 4.0

Housing:

1 = Single H=Dual 8mm Pitch

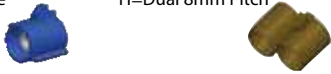

Options:

(dash) = -
 E = Enhanced Gen 3.5
 6 = 6 GHz
 R = Reverse Port On Duals
Other options available, please contact factory

Tab Location:



Key Code: See Key Code Chart

Style:

S=Straight R=Right Angle A=Angled/Other than 90 Degrees



Gender:

J = Jack P = Plug

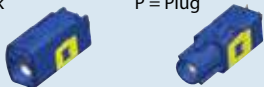

Options:

(dash) = - T = TPA (Terminal Position Assurance)

Termination

Cable Mount Connectors

- C01 = RG-174/188/316
- C04 = RG-58
- C65 = RG-59/62 Type
- C71 = RG-71/UM
- D46 = DACAR 462
- M59 = Mini 59 Type
- C00 = RG-174/188/316 and RG-58 *
- C88 = RG-174/188/316 and RG-71/UM *
- C99 = RG-174/188/316 and RG-59/62 Type *

*More cables available, please consult factory
 * available on dual connectors only*

Printed Circuit Board Connector

PCB = Printed Circuit Board Connector

Options:

- = With contact supplied W = Contact supplied separately E = Sealed Connector *Other options available, please contact factory*

Character Codes - Cable Jacks

- 0 = Without Clip Provision
- 3 = 360 Degree Design (Right Angle Only)
- 6 = Single/Dual With Clip Provision
- S = Low Profile Without Clip Provision

Character Codes - Cable Plugs

- 0 = Single Without Bracket; Without Clip Provision
- 1 = Single/Dual Without Bracket; With Clip Provision
- 6 = Single/Dual Without Bracket; With Clip Provision
- 9 = Dual Without Bracket; Without Clip Provision

Please contact Amphenol RF for other cable requirements.

FAKRA Cable Connectors



GENERATION 4.0 FAKRA CONNECTORS

Generation 4.0 plugs and jacks feature stamped and formed construction and are designed for fully automated termination by the user. The center contacts and connector bodies are supplied strip-fed on tape and reel. Generation 4.0 connectors are designed for high volume users whose factory utilizes high-speed automated cable assembly production. The FAKRA connector housings for Generation 4.0 are removable, permitting field replacement, if necessary.

Single Straight Jack



Without Mounting Clip Provision

Part Number	Cable Code	Cable Type	Cable Assembly Instructions
4FA1-NXSJ-C01W0	C01	RG-174/188/316	349-50874
4FA1-NXSJ-C04W0	C04	RG-58	349-50874
4FA1-NXSJ-C65W0	C65	RG-59/62	349-50874
4FA1-NXSJ-M59W0	M59	Mini 59 Type	349-50874



With Mounting Clip Provision

Part Number	Cable Code	Cable Type	Cable Assembly Instructions
4FA1-NXSJ-C01W6	C01	RG-174/188/316	349-50874
4FA1-NXSJ-C04W6	C04	RG-58	349-50874
4FA1-NXSJ-C65W6	C65	RG-59/62	349-50874
4FA1-NXSJ-M59W6	M59	Mini 59 Type	349-50874

Single Right Angle Jack



Without Mounting Clip Provision

Part Number	Cable Code	Cable Type	Cable Assembly Instructions
4FA1-NXRJ-C01W3	C01	RG-174/188/316	349-50906
4FA1-NXRJ-C04W3	C04	RG-58	349-50906
4FA1-NXRJ-C65W3	C65	RG-59/62	349-50906
4FA1-NXRJ-M59W3	M59	Mini 59 Type	349-50906

Single Straight Plug



Without Mounting Clip Provision

Part Number	Cable Code	Cable Type	Cable Assembly Instructions
4FA1-NXSP-C01W1	C01	RG-174/188/316	349-50874
4FA1-NXSP-C04W1	C04	RG-58	349-50874
4FA1-NXSP-C65W1	C65	RG-59/62 Type	349-50874
4FA1-NXSP-M59W1	M59	Mini 59 Type	349-50874

Dual Straight Jack



With Mounting Clip Provision

Part Number	Cable Code	Cable Type	Cable Assembly Instructions
4FAH-NXSJ-C01W6	C01	RG-174/188/316	349-50913
4FAH-NXSJ-C04W6	C04	RG-58	349-50913
4FAH-NXSJ-C00W6	C00	RG-174/188/316 and RG-58	349-50913
4FAH-NXSJ-C99W6	C99	RG-174/188/316 and RG 59/62	349-50913

Dual Straight Plug



Without Mounting Clip Provision

Part Number	Cable Code	Cable Type	Cable Assembly Instructions
4FAH-NXSP-C01W9	C01	RG-174/188/316	349-50913
4FAH-NXSP-C04W9	C04	RG-58	349-50913
4FAH-NXSP-C00W9	C00	RG-174/188/316 and RG-58	349-50913
4FAH-NXSP-C99W9	C99	RG-174/188/316 and RG 59/62	349-50913

Straight Female Contacts



Part Number	Description	Cable Type
923-40120	Straight Female Contact	RG-174/188/316 and RG 59/62
923-40121	Straight Female Contact	RG-58
923-40122	Straight Female Contact	Mini 59 Type

Right Angle Female Contacts

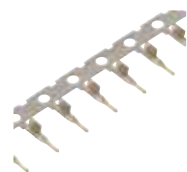

Part Number	Description	Cable Type
FKCP08404	Right Angle Female Contact	RG-174/188/316 and RG-59/62
FKCP08405	Right Angle Female Contact	RG-58
923-40144	Right Angle Female Contact	Mini 59 Type

Straight Male Contacts

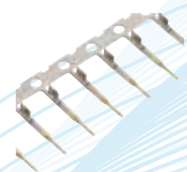

Part Number	Description	Cable Type
923-40116	Straight Male Contact	RG-174/188/316 and RG-59/62
923-40117	Straight Male Contact	RG-58
923-40118	Straight Male Contact	Mini 59 Type

*Specific mechanical key code designation replaces "X" in all part numbers listed.

GENERATION 3.0 FAKRA CONNECTORS

Generation 3.0 FAKRA connectors feature a closed-entry interface and a protected outer contact, making the connector more robust than traditional SMB connectors. The stamped and formed center contact is supplied on a reel, allowing for semi-automated termination onto the cable.

Single Straight Jack



Without Mounting Clip Provision

Part Number	Cable Code	Cable Type	Cable Assembly Instructions
3FA1-NXSJ-C01W0	C01	RG-174/188/316	349-50801
3FA1-NXSJ-C04W0	C04	RG-58	349-50801
3FA1-NXSJ-C65W0	C65	RG-59/62	349-50801
3FA1-NXSJ-D46W0	D46	DACAR 462	349-50801
3FA1-NXSJ-M59W0	M59	Mini 59 Type	349-50801



With Mounting Clip Provision

Part Number	Cable Code	Cable Type	Cable Assembly Instructions
3FA1-NXSJ-C01W6	C01	RG-174/188/316	349-50801
3FA1-NXSJ-C04W6	C04	RG-58	349-50801
3FA1-NXSJ-C65W6	C65	RG-59/62	349-50801
3FA1-NXSJ-D46W6	D46	DACAR 462	349-50801
3FA1-NXSJ-M59W6	M59	Mini 59 Type	349-50801

Single Right Angle Jack (Center Contact Pre-Assembled)



Without Mounting Clip Provision

Part Number	Cable Code	Cable Type	Cable Assembly Instructions
3FA1ENXRJ-C01-3	C01	RG-174/188/316/DACAR 462	349-50785
3FA1ENXRJ-C04-3	C04	RG-58	349-50785
3FA1ENXRJ-C65-3	C65	RG-59/62	349-50785
3FA1ENXRJ-C71-3	C71	RG-71/UM	349-50785
3FA1ENXRJ-M59-3	M59	Mini 59 Type	349-50785

Elongated Single R/A Jack (Center Contact Pre-Assembled)



With Mounting Clip Provision

Part Number	Cable Code	Cable Type	Cable Assembly Instructions
3FA1MNXRJ-C01F6	C01	RG-174/188/316	349-50785
3FA1MNXRJ-C04F6	C04	RG-58	349-50785
3FA1MNXRJ-C65F6	C65	RG-59/62	349-50785

Dual Straight Jack



With Mounting Clip Provision

Part Number	Cable Code	Cable Type	Cable Assembly Instructions
3FAH-NXSJ-C01W6	C01	RG-174/188/316	349-50767
3FAH-NXSJ-C04W6	C04	RG-58	349-50767
3FAH-NXSJ-C00W6	C00	RG-174/188/316 and RG-58	349-50767
3FAH-NXSJ-C88W6	C88	RG-174/188/316 and RG-7/UM	349-50767
3FAH-NXSJ-C99W6	C99	RG-174/188/316 and RG 59/62	349-50767

Straight Female Contacts



Part Number	Description	Cable Type
FKCP03301A	Straight Female Contact	RG-174/188/316, RG 59, RG-71/UM and DACAR 462
FKCP03302	Straight Female Contact	RG-58
FKCP03303	Straight Female Contact	Mini 59 Type

*Specific mechanical key code designation replaces "X" in all part numbers listed.

GENERATION 2.5 AND 2.0 FAKRA CONNECTORS

FAKRA Generation 2.0 and 2.5 connectors feature a die cast body and stamped contact, offering reduced installation costs for customers via a pre-assembled housing unit. This pre-assembled housing eliminates two loose components and their associated assembly and handling costs. Generation 2.5 center contacts are provided on a tape and reel for automated distribution and placement.

GEN 2.5 FAKRA CABLE CONNECTOR

Single Straight Plug



Without Mounting Clip Provision

Part Number	Cable Code	Cable Type	Cable Assembly Instructions
2FA1-NXSP-C01W1	C01	RG-174/188/316	349-50914
2FA1-NXSP-C04W1	C04	RG-58	349-50914
2FA1-NXSP-C65W1	C65	RG-59/62	349-50914
2FA1-NXSP-C71W1	C71	RG-71/UM	349-50914
2FA1-NXSP-D46W1	D46	DACAR 462	349-50914
2FA1-NXSP-M59W1	M59	Mini 59 Type	349-50914



With Mounting Clip Provision

Part Number	Cable Code	Cable Type	Cable Assembly Instructions
2FA1-NXSPTC01W6	C01	RG-174/188/316	349-50837
2FA1-NXSPTC04W6	C04	RG-58	349-50837
2FA1-NXSPTC65W6	C65	RG-59/62	349-50837

Dual Straight Plug



Without Mounting Clip Provision

Part Number	Cable Code	Cable Type	Cable Assembly Instructions
2FAH-NXSP-C01W9	C01	RG-174/188/316	349-50767
2FAH-NXSP-C04W9	C04	RG-58	349-50767
2FAH-NXSP-C00W9	C00	RG-174/188/316 and RG-58	349-50767
2FAH-NXSP-C88W9	C88	RG-174/188/316 and RG-71/UM	349-50767
2FAH-NXSP-C99W9	C99	RG-174/188/316 and RG 59/62	349-50767



With Mounting Clip Provision

Part Number	Cable Code	Cable Type	Cable Assembly Instructions
2FAH-NXSP-C01W6	C01	RG-174/188/316	349-50767
2FAH-NXSP-C04W6	C04	RG-58	349-50767
2FAH-NXSP-C00W6	C00	RG-174/188/316 and RG-58	349-50767

Straight Male Contacts



Part Number	Description	Cable Type
FKCP03401A	Straight Male Contact	RG-174/188/316 and RG 59, RG-71/UM and DACAR 462
FKCP03402	Straight Male Contact	RG-58
FKCP03403	Straight Male Contact	Mini 59 Type

GEN 2.0 FAKRA CABLE CONNECTORS

Single Straight Plug



Without Mounting Clip Provision

Part Number	Cable Code	Cable Type	Cable Assembly Instructions
2FA1-NXSP-C01-1	C01	RG-174/188/316	349-50695
2FA1-NXSP-C04-1	C04	RG-58	349-50695
2FA1-NXSP-C65-1	C65	RG-59/62	349-50695
2FA1-NXSP-C71-1	C71	RG-71/UM	349-50695

*Specific mechanical key code designation replaces "X" in all part numbers listed.

GENERATION 1.0 FAKRA CONNECTORS

FAKRA Generation 1.0 utilizes a modified metal SMB connector embedded within a plastic housing, which is color-coded and key-coded for ease of identification and to help eliminate assembly errors. Our standard FAKRA connectors are designed to perform up to 4.0 GHz and meet the electrical, mechanical and environmental standards of the automotive industry.

Single Straight Jack



Without Mounting Clip Provision

Part Number	Cable Code	Cable Type	Cable Assembly Instructions
FA1-NXSJ-C01-0	C01	RG-174/188/316	349-50782
FA1-NXSJ-C04-0	C04	RG-58	349-50782

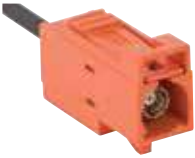

With Mounting Clip Provision

Part Number	Cable Code	Cable Type	Cable Assembly Instructions
FA1-NXSJ-C01-6	C01	RG-174/188/316	349-50782
FA1-NXSJ-C04-6	C04	RG-58	349-50782

Single Straight Plug



Without Mounting Clip Provision

Part Number	Cable Code	Cable Type	Cable Assembly Instructions
FA1-NXSP-C01-1	C01	RG-174/188/316	349-50781
FA1-NXSP-C04-1	C04	RG-58	349-50781

Single Straight Plug w/ Bracket



Part Number	Cable Code	Cable Type	Cable Assembly Instructions
FA1-NXSP-C01-0	C01	RG-174/188/316	349-50781
FA1-NXSP-C04-0	C04	RG-58	349-50781

Single Straight Plug - Panel Mount



Without Mounting Clip Provision

Part Number	Cable Code	Cable Type	Cable Assembly Instructions
FA1-NXSP-C01-5	C01	RG-174/188/316	349-50784

*Specific mechanical key code designation replaces "X" in all part numbers listed.

SEALED FAKRA CONNECTORS

Sealed IP67 FAKRA SMB connectors are tested to GMW3191 standards and utilize both internal and external o-rings and adhesive heat shrink tubing in order to prevent dust and water ingress. These connectors are ideal for applications exposed to harsh environmental elements including construction, trucking, and outdoor communications.

Sealed Single Straight Jack



Without Mounting Clip Provision

Part Number	Cable Code	Cable Type	Cable Assembly Instructions
3FA1-NXSJ-C01E0	C01	RG-174/188/316, DACAR 462	349-50832
3FA1ENXSJ-C04E0	C04	RG-58	349-50832



With Mounting Clip Provision

Part Number	Cable Code	Cable Type	Cable Assembly Instructions
3FA1-NXSJ-C01E6	C01	RG-174/188/316, DACAR 462	349-50832

Low Profile Sealed Single Straight Jack



Without Mounting Clip Provision

Part Number	Cable Code	Cable Type	Cable Assembly Instructions
3FA1ENXSJ-C01ES	C01	RG-174/188/316, DACAR 462	349-50910
3FA1ENXSJ-C04ES	C04	RG-58	349-50910
3FA1ENXSJ-C65ES	C65	RG-59/62	349-50910

Sealed Single R/A Jack (Center Contact Pre-Assembled)



Without Mounting Clip Provision

Part Number	Cable Code	Cable Type	Cable Assembly Instructions
3FA1ENXRJ-C01ER	C01	RG-174/188/316, DACAR 462	349-50883
3FA1ENXRJ-C04E3	C04	RG-58	349-50883
3FA1ENXRJ-C65E3	C65	RG-59/62	349-50883

Sealed Single Straight Plug



Without Mounting Clip Provision

Part Number	Cable Code	Cable Type	Cable Assembly Instructions
2FA1-NXSP-C01E1	C01	RG-174/188/316, DACAR 462	349-50832
2FA1-NXSP-C04E1	C04	RG-58	349-50832
2FA1-NXSP-C65E1	C65	RG-59/62	349-50832



With Mounting Clip Provision

Part Number	Cable Code	Cable Type	Cable Assembly Instructions
2FA1-NXSP-C01E6	C01	RG-174/188/316, DACAR 462	349-50832
2FA1-NXSP-C04E6	C04	RG-58	349-50832
2FA1-NXSP-C65E6	C65	RG-59/62	349-50832

Straight Female Contacts



Part Number	Description	Cable Type
FKCP03301A	Straight Female Contact, Selective Plated	RG-174/188/316 and DACAR 462
FKCP08402	Straight Female Contact, Gold Plated	RG-174/188/316 and DACAR 462
FKCP03302	Straight Female Contact	RG-58

Straight Male Contacts



Part Number	Description	Cable Type
FKCP03401A	Straight Male Contact	RG-174/188/316, RG-59, and RG-71/UM
FKCP03402	Straight Male Contact	RG-58

6.0 GHz FAKRA CONNECTORS

6.0 GHz connectors are designed for excellent VSWR performance from DC to 6.0 GHz, and meet the mechanical and environmental requirements of the automotive industry.

Single Straight Jack



With Mounting Clip Provision

Part Number	Cable Code	Cable Type	Cable Assembly Instructions
3FA16NXSJ-C01-6	C01	RG-174/188/316	349-50915
3FA16NXSJ-C04-6	C04	RG-58	349-50915

Single Straight Plug



Without Mounting Clip Provision

Part Number	Cable Code	Cable Type	Cable Assembly Instructions
2FA16NXSP-C01-1	C01	RG-174/188/316	349-50915
2FA16NXSP-C04-1	C04	RG-58	349-50915

*Specific mechanical key code designation replaces "X" in all part numbers listed.

FAKRA Adapters

Our FAKRA adapters are available in SMB to SMA configurations, which utilize a universal key code on the FAKRA side. FAKRA adapters can be used in a variety of applications, e.g. as antenna adapters and for test purposes.



Part Number	Description
APH-FKJ-SMAJ	Universal FAKRA Jack to SMA Jack



Part Number	Description
APH-FKP-SMAP	Universal FAKRA Plug to SMA Plug

FAKRA PCB CONNECTORS

Amphenol offers a variety of FAKRA PCB mount connectors to mate to the various cable-mounted connectors shown above. Vertical, right angle, dual, and edge-mount configurations are all part of our standard offering.

Image	Part Number	Line Drawing	PCB Layout Reference
-------	-------------	--------------	----------------------

Single Right Angle PCB Mount



4FA1-NXRP-PCB-4

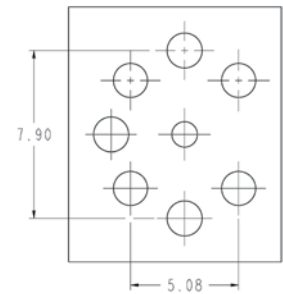

4FA1-NXRP-PCB-6

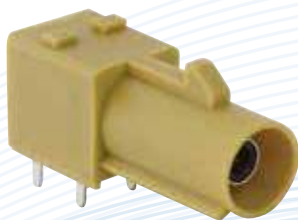
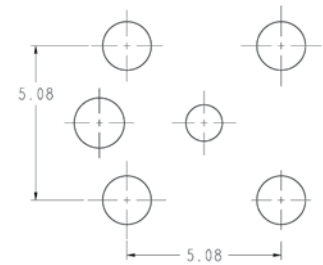
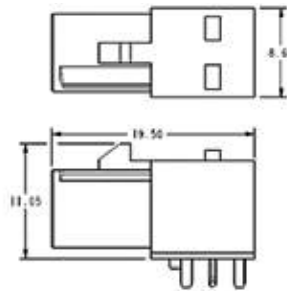

4FA1-NXRP-PCB-8

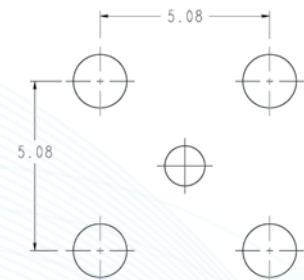
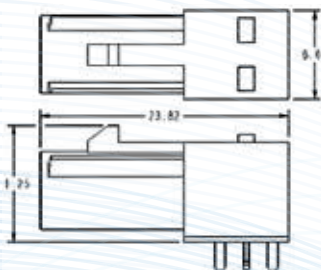

*Refer to customer outline drawing for detailed PCB layout dimensions

Image

Part Number

Line Drawing

PCB Layout Reference



2FA1-NXRP-PCBA3

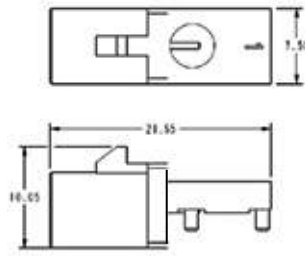

2FA1-NXRP-PCBD1

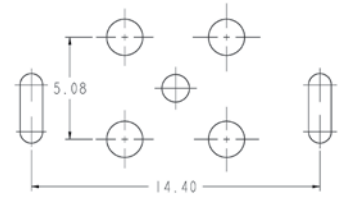
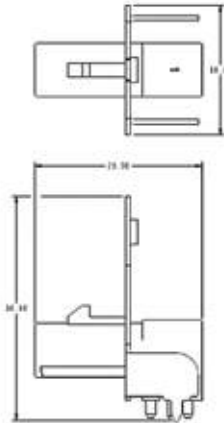

2FA1-NXRP-PCB-5

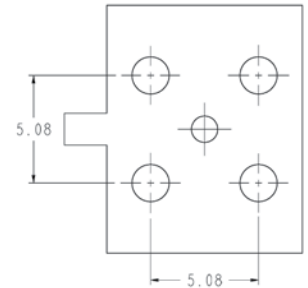
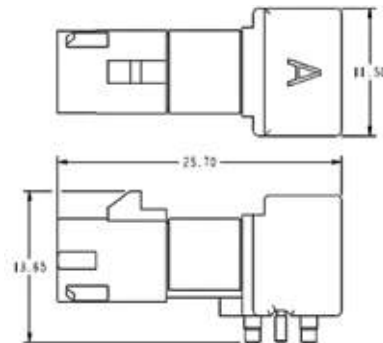

2FA1-NXRP-PCB-6

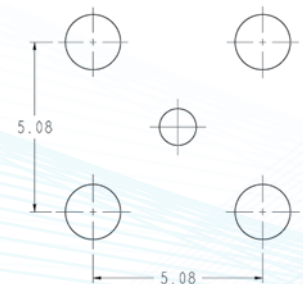
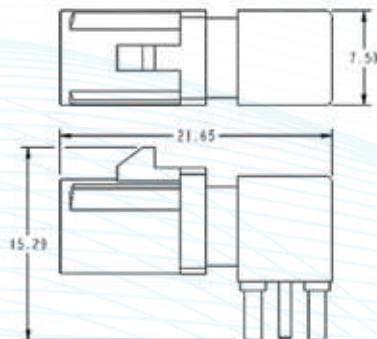

Image

Part Number

Line Drawing

PCB Layout Reference



2FA1-NXRP-PCBB2

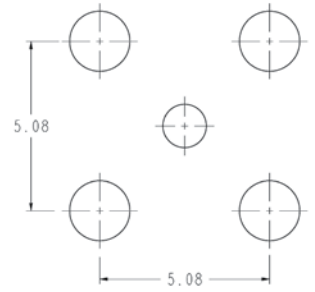
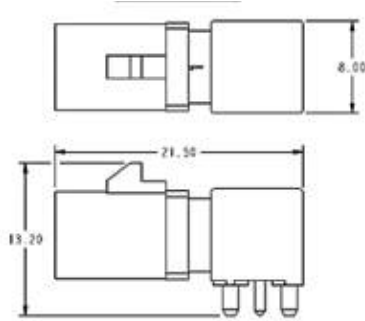

FA1-NXRP-PCB-6A

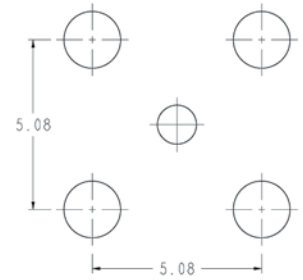
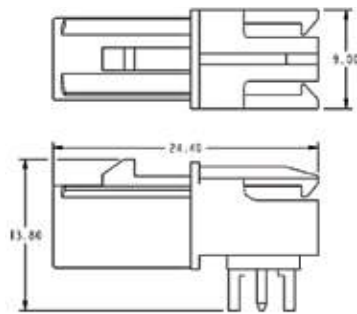

FA1-NXRP-PCB-8A

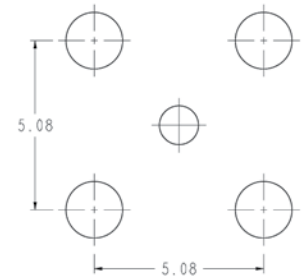
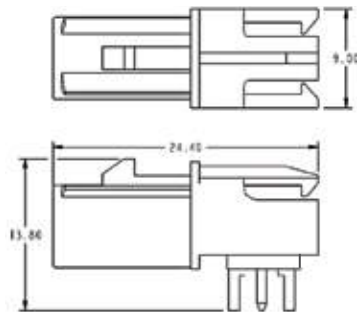

FA1-NXRP-PCBT10

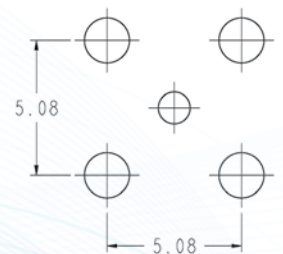
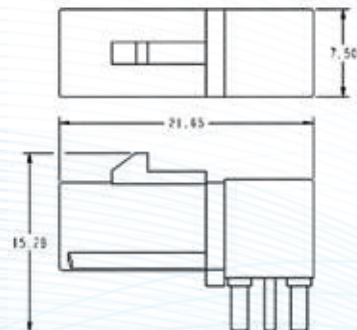

*Refer to customer outline drawing for detailed PCB layout dimensions

Image

Part Number

Line Drawing

PCB Layout Reference



FA1-NXRP-PCBT17

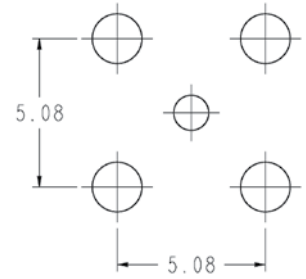
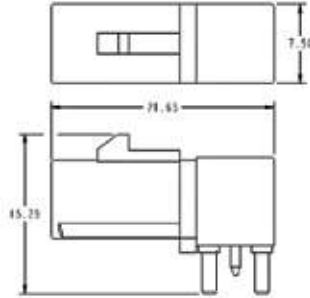

Single Edgemount PCB



2FA1-NXSP-PCB-3

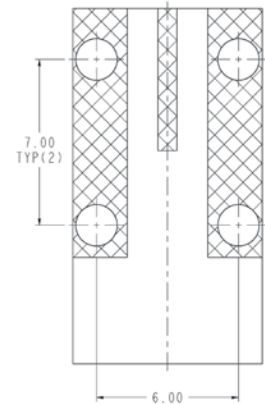
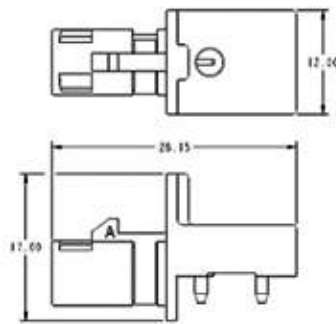

2FA1-WXSP-1000

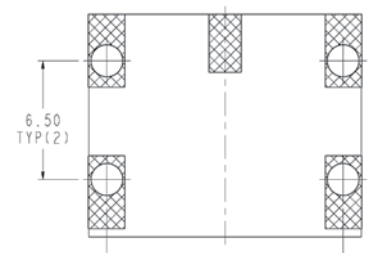
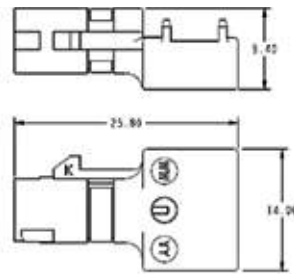

2FA1-WXSP-PCBA3

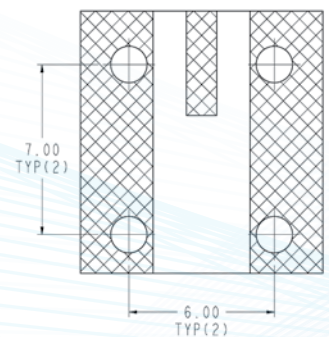
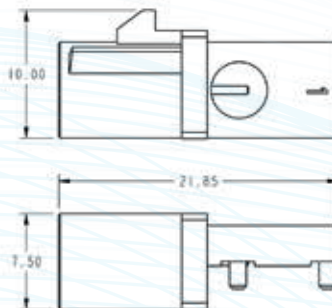

**Refer to customer outline drawing for detailed PCB layout dimensions*

Image

Part Number

Line Drawing

PCB Layout Reference



2FA1-NXSP-PCBA9

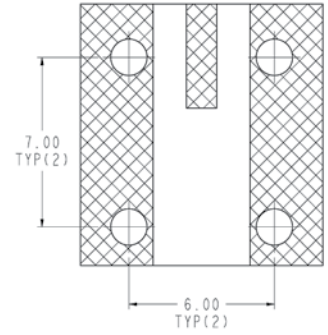
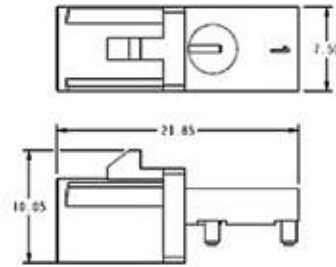

4FA1-NXRP-PCB-3

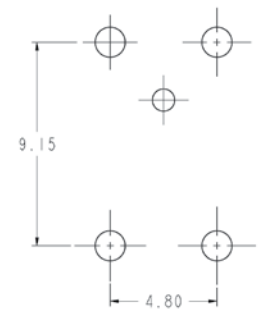
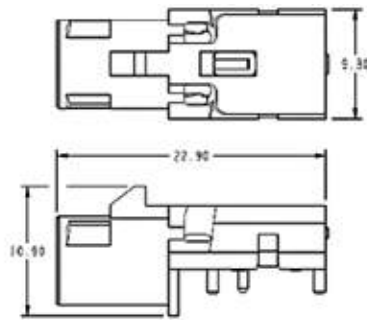

Single Vertical PCB Mount



2FA1-NXSP-PCBC5

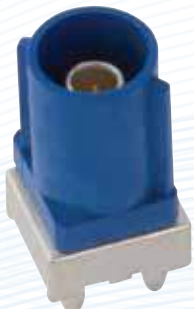
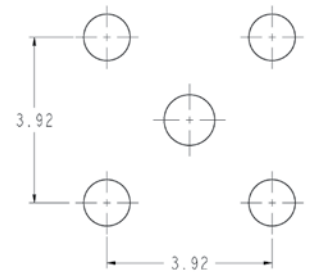
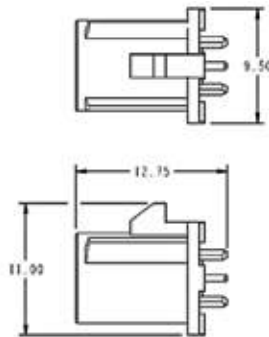

2FA1-NXSP-PCBB6

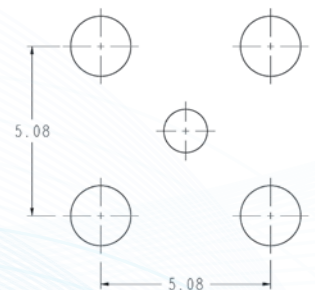
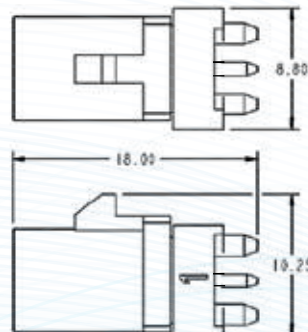

*Refer to customer outline drawing for detailed PCB layout dimensions

Image

Part Number

Line Drawing

PCB Layout Reference



FA1-NXSP-PCB-2

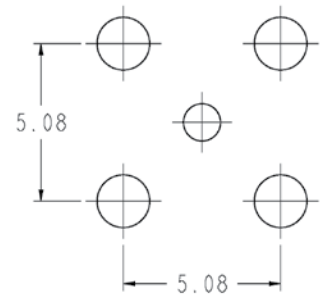
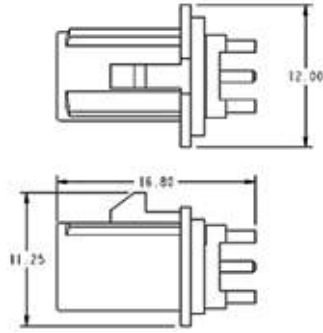

Dual Vertical PCB Mount



2FAH-NXSP-PCB-1

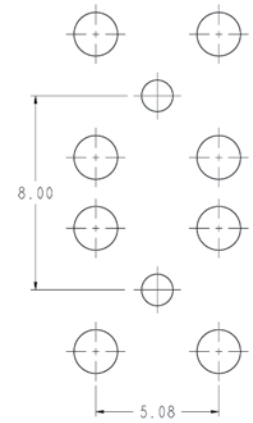
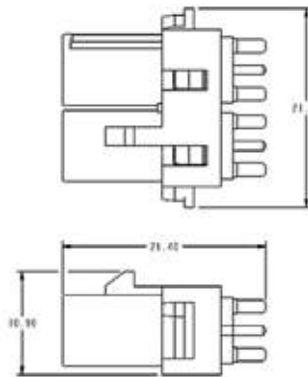



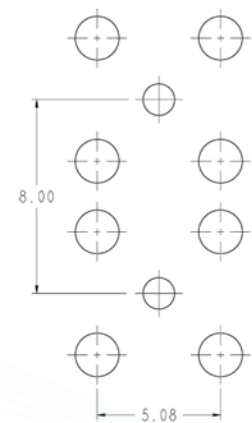
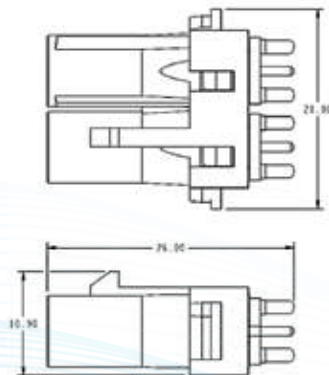





2FAH-NXSP-PCB-2



HSD CABLE ASSEMBLY ORDERING INFORMATION

Our HSD (High Speed Data) series was developed in response to the increasing demand for high speed data communication systems in vehicles. These connectors feature 100 Ohm nominal impedance and support data rates up to 1.6 GBPS. HSD connectors can be used in combination with a variety of protocols such as LVDS (Low Voltage Differential Signaling), GVIF (Gigabit Video interface), USB, IEEE 1394, as well as Ethernet protocols.

HSD Cable Assembly Part Numbering System

H	S	D	S	J	X	S	J	X	1	5	2	4	0	2
Product Family: HSD = High Speed Data														
Connector A Orientation: S = Straight  R = Right Angle 														
Connector A Gender: J = Jack  P = Plug 														
Connector A Keying: A,B,C,D,E,Z (North only) G,H,J,K,L,M,O (South only) <i>See additional information on page 30</i>														
Connector B Orientation: S = Straight  R = Right Angle 														
Connector B Gender: J = Jack  P = Plug 														
Connector B Keying: A,B,C,D,E,F,Z (North only) G,H,J,K,L,M,O (South only) <i>See additional information on page 30</i>														
Length: 100 - 9999 Length in MM (100 Millimeters - 9999 Millimeters) 100M - 990M Length in M (10.0 Meters - 99.9 Meters) Example: 105M = 10.5 Meters, 990M = 99 Meters														
Character Code: 01-99 <i>Please consult factory for additional information</i>														

HSD MECHANICAL CODING

	Jack	Plug	RAL	Color
A			9005	 Jet Black
B			9001	 Cream
C			5005	 Signal Blue
D			4004	 Claret Violet
E			6002	 Leaf Green
F			8011	 Nut Brown
G			7031	 Blue Grey
H			4003	 Heather Violet
J			1001	 Beige
K			1027	 Curry
L			6018	 Yellow Green
M			2003	 Pastel Orange
O			6027	 Light Green
Z			5021	 Water Blue

HSD CABLE ASSEMBLIES

HSD Cable Assemblies

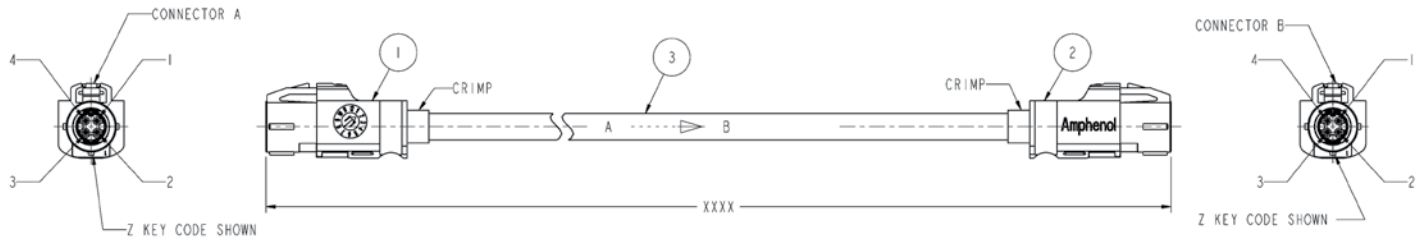

Part Number	Description	Wiring Configuration
HSDSJXRJXXXXX04	HSD Straight Jack to Right Angle Jack, DACAR 535 C/A	1-4, 2-3, 3-2, 4-1
HSDSJXSJXXXXX07	HSD Straight Jack to Straight Jack, DACAR 535 C/A	1-4, 2-3, 3-2, 4-1
HSDSJXSJXXXXX08	HSD Straight Jack to Straight Jack, DACAR 535 C/A	1-1, 2-2, 3-3, 4-4

HSD CONNECTORS

Single Straight Jack



Without Mounting Clip Provision

Part Number	Cable Code	Cable Type	Cable Assembly Instructions
2HSD-NXSJ-C44W0	C44	DACAR 535 Type	349-50864



Without Mounting Clip Provision

Part Number	Cable Code	Cable Type	Cable Assembly Instructions
2HSD-SXSJ-C44W0	C44	DACAR 535 Type	349-50864

Single Straight Plug



Without Mounting Clip Provision

Part Number	Cable Code	Cable Type	Cable Assembly Instructions
2HSD-NXSP-C44W1	C44	DACAR 535 Type	349-50864



Without Mounting Clip Provision

Part Number	Cable Code	Cable Type	Cable Assembly Instructions
2HSD-SXSP-C44W1	C44	DACAR 535 Type	349-50864

Right Angle Jack



Without Mounting Clip Provision

Part Number	Cable Code	Cable Type	Cable Assembly Instructions
3HSD-DXRJ-C44W0	C44	DACAR 535 Type	349-50867



Without Mounting Clip Provision

Part Number	Cable Code	Cable Type	Cable Assembly Instructions
3HSD-LXRJ-C44W0	C44	DACAR 535 Type	349-50867



Without Mounting Clip Provision

Part Number	Cable Code	Cable Type	Cable Assembly Instructions
3HSD-RXRJ-C44W0	C44	DACAR 535 Type	349-50867



Without Mounting Clip Provision

Part Number	Cable Code	Cable Type	Cable Assembly Instructions
3HSD-UXRJ-C44W0	C44	DACAR 535 Type	349-50867

Straight Female Contacts



Part Number	Description	Cable Type
HDCP00401	Straight Female Contact	DACAR 535 Type

Straight Male Contact

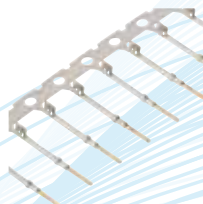

Part Number	Description	Cable Type
HDCP00501	Straight Male Contact	DACAR 535 Type

HSD PCB CONNECTORS

Image

Part Number

PCB Layout Reference



HSD-NXSP-PCB-2X

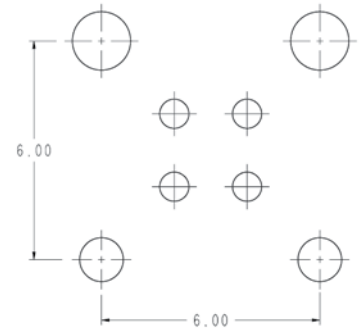

HSD-NXRP-PCB-3X

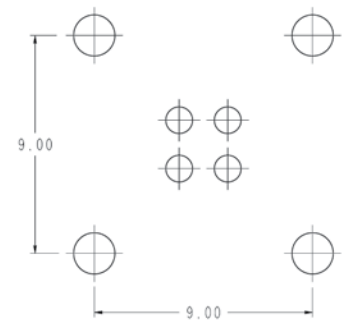

HSD-NXRP-PCB13X

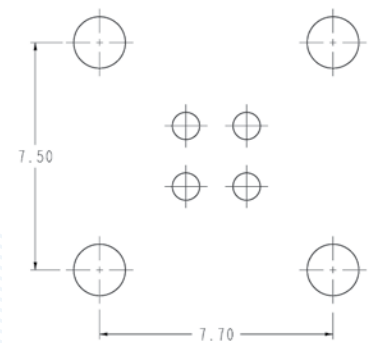

Part Number	Part Number	Part Number	Part Number
2FA16NXSP-C01-1 21	2FAH-NXSP-C88W9 18	3FAH-NXSJ-C01W6 17	923-40118 16
2FA16NXSP-C04-1 21	2FAH-NXSP-C99W9 18	3FAH-NXSJ-C04W6 17	923-40120 16
2FA1-NXRP-PCB-5 24	2FAH-NXSP-PCB-1 28	3FAH-NXSJ-C88W6 17	923-40121 16
2FA1-NXRP-PCB-6 24	2FAH-NXSP-PCB-2 28	3FAH-NXSJ-C99W6 17	923-40122 16
2FA1-NXRP-PCBA3 24	2HSD-NXSJ-C44W0 31	3HSD-DXRJ-C44W0 32	923-40144 16
2FA1-NXRP-PCBB2 25	2HSD-NXSP-C44W1 31	3HSD-LXRJ-C44W0 32	APH-FKJ-SMAJ 22
2FA1-NXRP-PCBD1 24	2HSD-SXSJ-C44W0 31	3HSD-RXRJ-C44W0 32	APH-FKP-SMAP 22
2FA1-NXSP-C01-1 18	2HSD-SXSP-C44W1 31	3HSD-UXRJ-C44W0 32	FA1-NXRP-PCB-6A 25
2FA1-NXSP-C01E1 20	3FA16NXSJ-C01-6 21	4FA1-NXRJ-C01W3 15	FA1-NXRP-PCB-8A 25
2FA1-NXSP-C01E6 20	3FA16NXSJ-C04-6 21	4FA1-NXRJ-C04W3 15	FA1-NXRP-PCBT10 25
2FA1-NXSP-C01W1 18	3FA1ENXRJ-C01-3 17	4FA1-NXRJ-C65W3 15	FA1-NXRP-PCBT17 26
2FA1-NXSP-C04-1 18	3FA1ENXRJ-C01ER 20	4FA1-NXRJ-M59W3 15	FA1-NXSJ-C01-0 19
2FA1-NXSP-C04E1 20	3FA1ENXRJ-C04-3 17	4FA1-NXRP-PCB-3 27	FA1-NXSJ-C01-6 19
2FA1-NXSP-C04E6 20	3FA1ENXRJ-C04E3 20	4FA1-NXRP-PCB-4 23	FA1-NXSJ-C04-0 19
2FA1-NXSP-C04W1 18	3FA1ENXRJ-C65-3 17	4FA1-NXRP-PCB-6 23	FA1-NXSJ-C04-6 19
2FA1-NXSP-C65-1 18	3FA1ENXRJ-C65E3 20	4FA1-NXRP-PCB-8 23	FA1-NXSP-C01-0 19
2FA1-NXSP-C65E1 20	3FA1ENXRJ-C71-3 17	4FA1-NXSJ-C01W0 15	FA1-NXSP-C01-1 19
2FA1-NXSP-C65E6 20	3FA1ENXRJ-M59-3 17	4FA1-NXSJ-C01W6 15	FA1-NXSP-C01-5 19
2FA1-NXSP-C65W1 18	3FA1ENXSJ-C01ES 20	4FA1-NXSJ-C04W0 15	FA1-NXSP-C04-0 19
2FA1-NXSP-C71-1 18	3FA1ENXSJ-C04E0 20	4FA1-NXSJ-C04W6 15	FA1-NXSP-C04-1 19
2FA1-NXSP-C71W1 18	3FA1ENXSJ-C04ES 20	4FA1-NXSJ-C65W0 15	FA1-NXSP-PCB-2 28
2FA1-NXSP-D46W1 18	3FA1ENXSJ-C65ES 20	4FA1-NXSJ-C65W6 15	FKCP03301A 17, 21
2FA1-NXSP-M59W1 18	3FA1MNXRJ-C01F6 17	4FA1-NXSJ-M59W0 15	FKCP03302 17, 21
2FA1-NXSP-PCB-3 26	3FA1MNXRJ-C04F6 17	4FA1-NXSJ-M59W6 15	FKCP03303 17
2FA1-NXSP-PCBA9 27	3FA1MNXRJ-C65F6 17	4FA1-NXSP-C01W1 16	FKCP03401A 18, 21
2FA1-NXSP-PCBB6 27	3FA1-NXSJ-C01E0 20	4FA1-NXSP-C04W1 16	FKCP03402 18, 21
2FA1-NXSP-PCBC5 27	3FA1-NXSJ-C01E6 20	4FA1-NXSP-C65W1 16	FKCP03403 18
2FA1-NXSPTC01W6 18	3FA1-NXSJ-C01W0 17	4FA1-NXSP-M59W1 16	FKCP08402 21
2FA1-NXSPTC04W6 18	3FA1-NXSJ-C01W6 17	4FAH-NXSJ-C00W6 16	FKCP08404 16
2FA1-NXSPTC65W6 18	3FA1-NXSJ-C04W0 17	4FAH-NXSJ-C01W6 16	FKCP08405 16
2FA1-WXSP-1000 26	3FA1-NXSJ-C04W6 17	4FAH-NXSJ-C04W6 16	HDCP00401 32
2FA1-WXSP-PCBA3 26	3FA1-NXSJ-C65W0 17	4FAH-NXSJ-C99W6 16	HDCP00501 32
2FAH-NXSP-C00W6 18	3FA1-NXSJ-C65W6 17	4FAH-NXSP-C00W9 16	HSD-NXRP-PCB13X 33
2FAH-NXSP-C00W9 18	3FA1-NXSJ-D46W0 17	4FAH-NXSP-C01W9 16	HSD-NXRP-PCB-3X 33
2FAH-NXSP-C01W6 18	3FA1-NXSJ-D46W6 17	4FAH-NXSP-C04W9 16	HSD-NXSP-PCB-2X 33
2FAH-NXSP-C01W9 18	3FA1-NXSJ-M59W0 17	4FAH-NXSP-C99W9 16	HSDSJXRJXXXXX04 31
2FAH-NXSP-C04W6 18	3FA1-NXSJ-M59W6 17	923-40116 16	HSDSJXSJXXXXX07 31
2FAH-NXSP-C04W9 18	3FAH-NXSJ-C00W6 17	923-40117 16	HSDSJXSJXXXXX08 31



ORDERING INFORMATION:

To obtain information on price and delivery, please contact your nearest Amphenol RF Sales Office.
For the primary customer service line, please call 1-800-627-7100.

Specifications in this catalog are subject to change without notice. While the information contained in this catalog has been carefully compiled to the best of our present knowledge, it is not intended as representation or warranty of any kind on our part regarding the suitability of the products concerned for any particular use or purpose. Please contact your Amphenol RF sales representative for additional information regarding the specifications.

Amphenol is a registered trademark of Amphenol Corporation.

Mouser Electronics

Authorized Distributor

Click to View Pricing, Inventory, Delivery & Lifecycle Information:

[Amphenol:](#)

[FA1-NDSJ-C04-6](#) [FA1-NESJ-C04-6](#) [FA1-NHSJ-C04-6](#) [FA1-NKSJ-C04-6](#) [2FA1-NZSP-PCBB6](#)