

## 2-Phase Constant-Frequency Synchronous, Dual-Output DC/DC Converter

### DESCRIPTION

This demonstration board provides 3.3V/4A and 5V/4A outputs using a low EMI, 2-phase, adjustable, dual switching regulator controller. This design is ideally suited for notebook computer system power supply applications. Operating the two high side MOSFETs 180° out of phase significantly reduces peak input ripple current, thereby reducing radiated and conducted EMI. External parts count, cost and size are minimized in this design. Output voltages can be externally set to as low as 0.8V. The controllers have overcurrent latch-off, which can be externally defeated, as well as internal current foldback for overload situations. The overcurrent latch-off on one controller can be configured to shut off the other output. A soft latch for overvoltage conditions is also provided. In addition to the two high current outputs, on-chip 5V/50mA

and 3.3V/25mA linear regulators are also included. In the optional standby mode, these internal regulators are capable of powering external system wake-up circuitry when both high current controllers are shut down. Two low current modes of operation are available: Burst Mode™ operation offers highest efficiency while Burst Disable mode provides constant-frequency operation down to 1% of maximum designed load. The frequency is externally DC-controlled over a 130kHz to 300kHz range. The controller can operate at up to 99% duty cycle for very low dropout conditions. The demonstration board operates on an input supply of from 5.2V to 30V. Refer to the LTC®1628 data sheet for other possible configurations. **Gerber files for this circuit board are available. Call the LTC factory.**

LT, LTC and LT are registered trademarks of Linear Technology Corporation. Burst Mode is a trademark of Linear Technology Corporation.

### PERFORMANCE SUMMARY Operating Temperature Range: 0°C to 50°C (continued on Page 2)

Input Voltage Range	Input Voltage Limited by External MOSFET Drive and Breakdown Requirements	5.2V to 30V
Outputs	Output Voltage: Controller 1; Externally Adjustable; 0 to 3A, 4A Pk	5V ± 0.10V
	Output Voltage: Controller 2; Externally Adjustable; 0 to 3A, 4A Pk	3.33V ± 0.067V
	5V Linear Regulator	5V ± 4%
	3.3V Linear Regulator	3.3V ± 4%
	Typical Output Ripple at 10MHz BW; 300kHz; I <sub>O</sub> = 1A; 3.3V and 5V Outputs; V <sub>IN</sub> = 15V	20mV <sub>p-p</sub>

### TYPICAL PERFORMANCE CHARACTERISTICS AND BOARD PHOTO

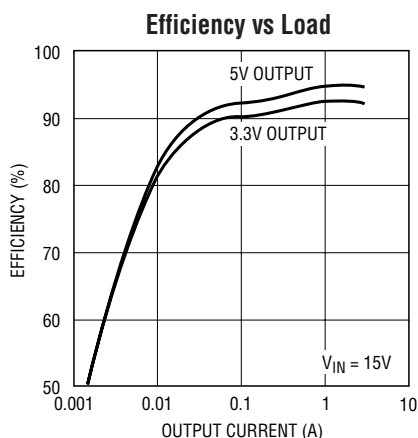

DC236TP01

**Demo Circuit 236A**

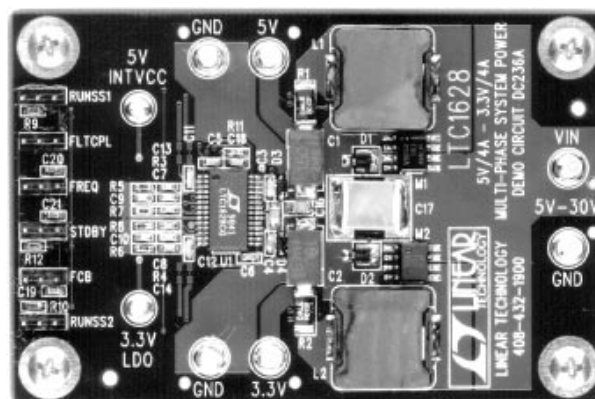

DC236 BP

### PERFORMANCE SUMMARY Operating Temperature Range: 0°C to 50°C (continued from Page 1)

Frequency	FREQSET Pin Tied to INTV <sub>CC</sub> Pin	300kHz
Line Regulation	V <sub>IN</sub> = 7V to 20V; 3.3V and 5V Outputs	±1mV
Load Regulation	I <sub>O</sub> = 0 to 3A; 3.3V and 5V Outputs	-20mV
Supply Current	V <sub>IN</sub> = 15V, 5V and 3.3V On, EXTV <sub>CC</sub> = V <sub>OUT1</sub>	390μA
Shutdown Current	V <sub>IN</sub> = 15V, STBYMD = 0V	20μA
Standby Current	5V INTV <sub>CC</sub> and 3.3V LDO On; V <sub>IN</sub> = 15V, RUN/SS1 and RUN/SS2 = 0V, 1MΩ STBYMD to V <sub>IN</sub>	125μA
Efficiency	V <sub>IN</sub> = 15V, 5V at 3A and 3.3V at 3A	94%

### QUICK START GUIDE

This demonstration board is easily set up to evaluate the performance of the LTC1628. Please follow the procedure outlined below for proper operation.

1. Refer to Figure 1 for board orientation and proper measurement equipment setup.
2. Place the jumpers as shown in the diagram. Temporarily leave off the STBYMD and FCB jumpers.
3. Connect the desired loads between V<sub>OUT1</sub>, V<sub>OUT2</sub> and their closest PGND terminals on the board. The loads can be up to 4A for V<sub>OUT1</sub> and 4A for V<sub>OUT2</sub>. Soldered wires should be used when the load current exceeds 1A in order to achieve optimum performance.
4. Connect the input power supply to the V<sub>IN</sub> and GND terminals on the right, center of the board. Do *not* increase V<sub>IN</sub> over 30V or the *MOSFETs may be damaged*. The recommended V<sub>IN</sub> to start is < 7V.
5. Switch on the desired channel(s) by removing the RUN/SS1 or RUN/SS2 jumper.
6. Measure V<sub>OUT1</sub> and V<sub>OUT2</sub> to verify output voltages of 5V ± 0.1V and 3.3V ± 0.067V, respectively, at load currents of up to 3A each.
7. **Active loads can cause confusing results. Refer to the active load discussion in the Operation section.**

### MEASUREMENT SETUP

The circuit shown in Figure 2 provides fixed voltages of 5V and 3.3V at currents of up to 4A. Figure 1 illustrates the correct measurement setup in order to verify the typical numbers found in the Performance Summary table. Small spring clip leads are very convenient for small-signal bench testing but should not be used at the current and impedance levels associated with this switching regulator. Soldered wire connections are required to properly ascertain the performance of this demonstration PC board. Do not tie the grounds together off the test board.

The six jumpers on the left side of the board are settable as follows: the center pin is connected to ground when the jumper is in the rightmost position. The center pin is connected to a positive bias source when the jumper is in the leftmost position.

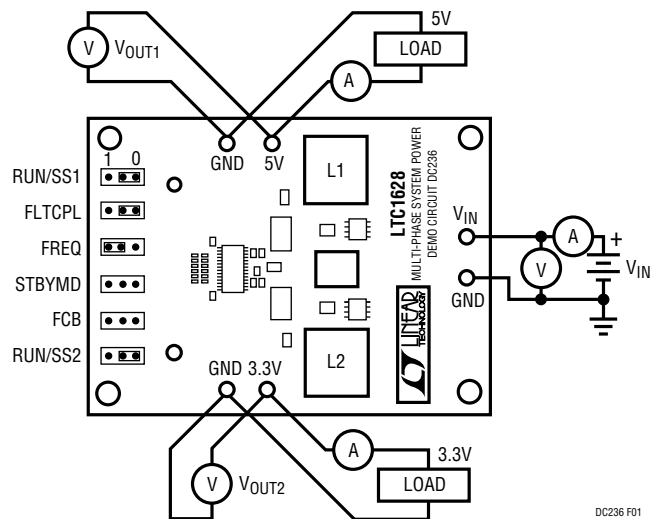

Figure 1. Proper Measurement Setup

PACKAGE AND SCHEMATIC DIAGRAMS



LTC1628CG

G PACKAGE  
28-LEAD PLASTIC SSOP

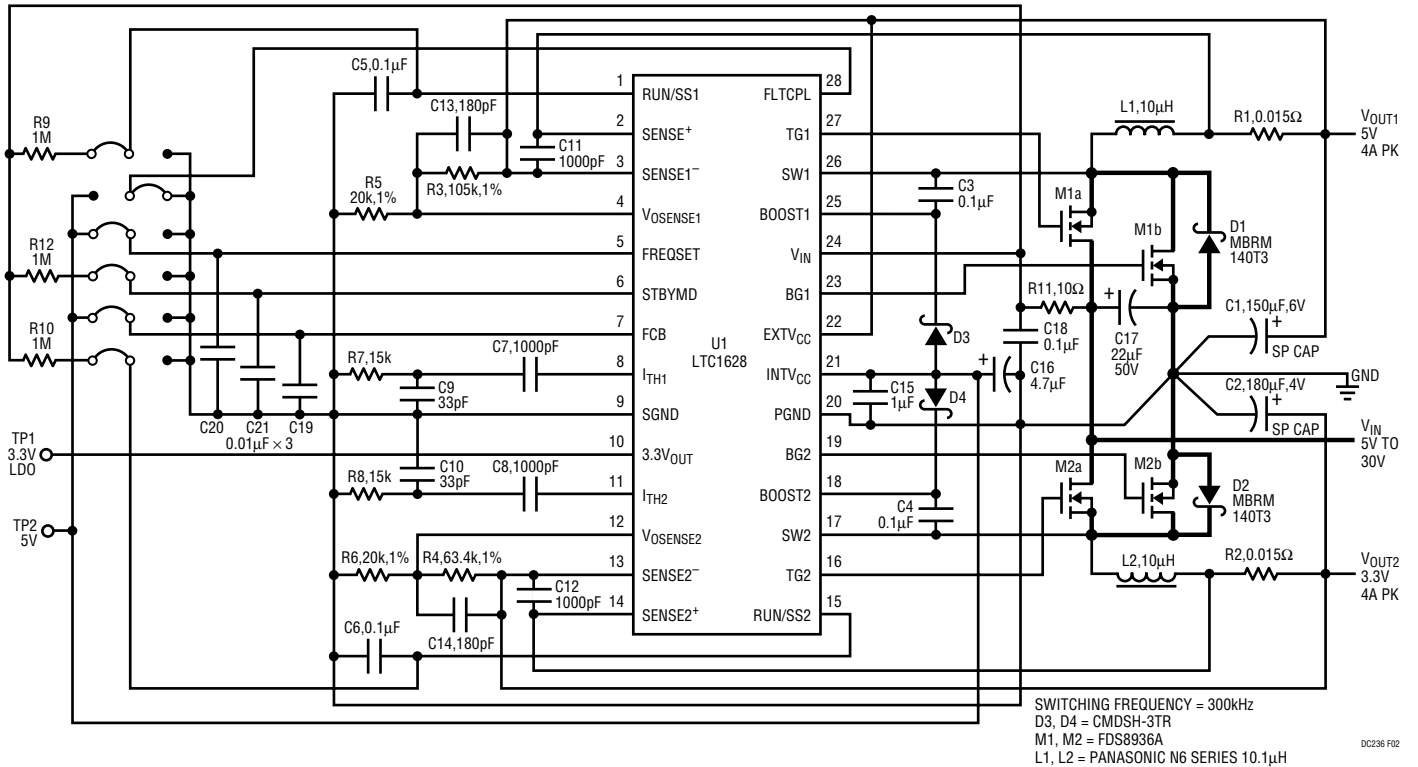

Figure 2. LTC1628 Fixed 5V/4A, 3.3V/4A, High Efficiency Dual Regulator

# DEMO MANUAL DC236

## DESIGN-READY SWITCHERS

### PARTS LIST

REFERENCE DESIGNATOR	QUANTITY	PART NUMBER	DESCRIPTION	VENDOR	TELEPHONE
C1	1	EEFUE0J151R	150 $\mu$ F 6.3V 20% Capacitor	Panasonic	(714) 373-7334
C2	1	EEFUE0G181R	180 $\mu$ F 4V 20% Capacitor	Panasonic	(714) 373-7334
C3 to C6, C18	5	0603ZC104MAT1A	0.1 $\mu$ F 10V 20% X7R Capacitor	AVX	(843) 946-0362
C7, C8, C11, C12	4	06033A102JAT1A	1000pF 25V 5% NPO Capacitor	AVX	(843) 946-0362
C9, C10	2	06035A330JAT1A	33pF 50V 5% NPO Capacitor	AVX	(843) 946-0362
C13, C14	2	06035C181JAT1A	180pF 50V 5% NPO Capacitor	AVX	(843) 946-0362
C15	1	0805ZC105MAT1A	1 $\mu$ F 10V 20% X7R Capacitor	AVX	(843) 946-0362
C16	1	TACR475M010R	4.7 $\mu$ F 10V 20% Tantalum Capacitor	AVX	(207) 282-5111
C17	1	THCR70E1H226ZT	22 $\mu$ F 50V Y5U Capacitor	Marcon	(847) 696-2000
C19 to C21	3	0603ZC103KAT1A	0.01 $\mu$ F 10V 10% X7R Capacitor	AVX	(843) 448-9411
D1, D2	2	MBRM140T3	40V 1A Schottky Diode	ON Semiconductor	(602) 244-6600
D3, D4	2	CMDSH-3TR	30V 0.1A Schottky Diode	Central	(516) 435-1110
L1, L2	2	CEP123-8ROMC or CDRH125-100MC or ETQP6F102HFA	8 $\mu$ H Low Profile Inductor 10 $\mu$ H Inductor 10 $\mu$ H Inductor	Sumida Panasonic	(408) 982-9660 (714) 373-7334
M1, M2	2	FDS8936A	Dual N-Channel MOSFET	Fairchild	(408) 822-2126
R1, R2	2	LR1206-01-R015-F	0.015 $\Omega$ 1/4W 1% Chip Resistor	IRC	(316) 992-7900
R3	1	CR16-1053FM	105k 1/16W 1% Chip Resistor	TAD	(800) 508-1521
R4	1	CR16-6342FM	63.4k 1/16W 1% Chip Resistor	TAD	(800) 508-1521
R5, R6	2	CR16-2002FM	20k 1/16W 1% Chip Resistor	TAD	(800) 508-1521
R7, R8	2	CR16-153JM	15k 1/16W 5% Chip Resistor	TAD	(714) 255-9123
R9, R10, R12	3	CR16-105JM	1M 1/16W 5% Chip Resistor	TAD	(714) 255-9123
R11	1	CR16-100JM	10 $\Omega$ 1/16W 5% Chip Resistor	TAD	(714) 255-9123
U1	1	LTC1628CG28	Multiphase Dual DC/DC Controller IC	LTC	(408) 432-1900

### MANUFACTURER TELEPHONE DIRECTORY

MANUFACTURER	USA	EUROPE	JAPAN	HONG KONG	SINGAPORE	TAIWAN/KOREA
AVX	(843) 448-9411	44-1252-770-000	81-751-592-3897	852-2-363-3303	65-258-2833	886-2-516-7010
BH Elect.	(612) 894-9590					
Central	(516) 435-1110	49-0816-143-963				822-2-268-9795
Coilcraft	(847) 639-6400			886-2-264-3646	65-296-6933	886-2-264-3646
Fairchild	(888) 522-5372	44-1793-856-856	81-3-5620-6175	852-2-273-7200	65-252-5077	886-2-712-0500
Gowanda	(716) 532-2234					
IR	(310) 322-3331	44-1883-713-215	81-3-3983-0086	852-2-803-7380	65-221-8371	822-2-858-8773
IRC	(316) 992-7900			852-2-388-0629	65-280-0200	0342-43-2822
Kemet	(864) 963-6300	44-1279-757-343		852-2-305-1168	65-484-2220	886-2-752-8585
Linear Technology	(408) 432-1900	44-1276-677-676	81-3-3267-7891	852-2-803-7380	65-753-2692	886-2-521-7575
Midcom	(605) 886-4385					
Murata	(800) 831-9172					
Marcon	(847) 696-2000					
ON Semiconductor	(602) 244-6600		81-3-3521-8315	852-2-662-9298	65-481-8188	
Panasonic	(201) 348-7522					

## MANUFACTURER TELEPHONE DIRECTORY

MANUFACTURER	USA	EUROPE	JAPAN	HONG KONG	SINGAPORE	TAIWAN/KOREA
Sanyo	(619) 661-6835	49-06102-7154-17	81-3-0720-70-1005	852-2-887-2109	65-747-9755	
Sumida	(847) 956-0666		81-3-3607-5111	852-2-880-6688	65-296-3388	886-2-726-2177
TAD	(800) 508-1521					
Taiyo Yuden	(800) 348-2496	44-1494-464-642	81-3-3833-5441	852-2-736-3803	65-861-4400	886-2-797-2155
Temic	(408) 970-5700	44-1344-707-300	81-3-5562-3321	852-2-378-9789	65-788-6668	886-2-755-6108
Toko	(847) 699-3430					
Token	(408) 432-8020	44-1236-780-850		852-2-730-0028		886-2-521-3998

## OPERATION

### Theory and Benefits of 2-Phase Operation

The LTC1628 dual high efficiency DC/DC controller brings the considerable benefits of 2-phase operation to portable applications for the first time. Notebook computers, PDAs, handheld terminals and automotive electronics will all benefit from the lower input filtering requirement, reduced electromagnetic interference (EMI) and increased efficiency associated with 2-phase operation.

Why the need for 2-phase operation? Before the LTC1628, constant-frequency dual switching regulators operated both channels in phase (i.e., 1-phase operation). This means that both switches turned on at the same time, causing current pulses of up to twice the amplitude of those for one regulator to be drawn from the input capacitor and battery. These large amplitude current pulses increased the total RMS current flowing from the input

capacitor, requiring the use of more expensive input capacitors and increasing both EMI and losses in the input capacitor and battery.

With 2-phase operation, the two channels of the dual switching regulator are operated 180 degrees out of phase. This effectively interleaves the current pulses coming from the switches, greatly reducing the overlap time where they add together. The result is a significant reduction in total RMS input current, which, in turn, allows less expensive input capacitors to be used, reduces shielding requirements for EMI and improves real world operating efficiency.

Figure 3 compares the input waveforms for a representative 1-phase dual switching regulator to the new LTC1628 2-phase dual switching regulator. An actual measurement of the RMS input current under these conditions shows

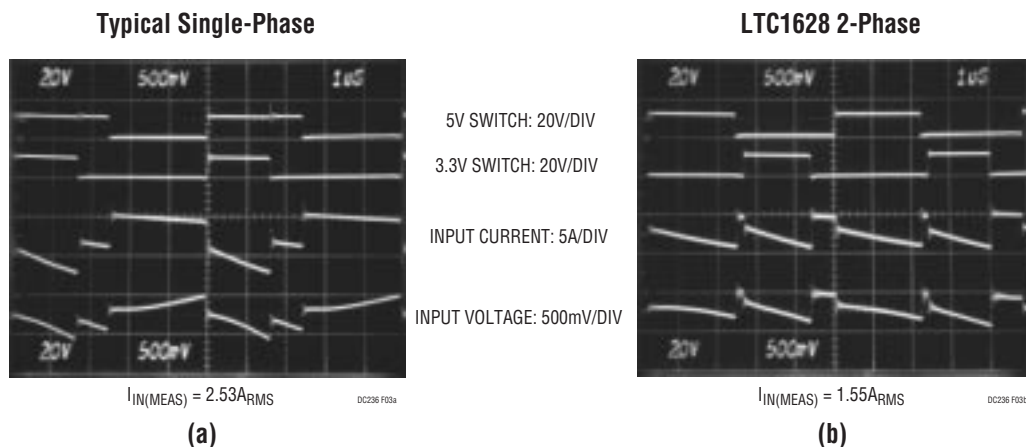

**Figure 3. Input Waveforms Comparing Single-Phase and 2-Phase Operation for Dual Switching Regulators Converting 12V to 5V and 3.3V at 3A Each. The Reduced Input Ripple with the LTC1628 2-Phase Regulator Allows Less Expensive Input Capacitors, Reduces Shielding Requirements for EMI and Improves Efficiency**



### OPERATION

that 2-phase operation lowers the input current from 2.53A<sub>RMS</sub> to 1.55A<sub>RMS</sub>.

Although this is an impressive reduction in itself, remember that the power losses are proportional to  $I_{RMS}^2$ , meaning that the actual power wasted is reduced by a factor of 2.66. The reduced input ripple voltage also means less power lost in the input power path, which could include batteries, switches, trace/connector resistances and protection circuitry. Improvements in both conducted and radiated EMI also directly accrue as a result of the reduced RMS input current and voltage.

Of course, the improvement afforded by 2-phase operation is a function of the dual switching regulator’s relative duty cycles which, in turn, are dependent upon the input voltage  $V_{IN}$  (Duty Cycle =  $V_{OUT}/V_{IN}$ ). Figure 4 shows how the RMS input current varies for 1-phase and 2-phase operation for 3.3V and 5V regulators over a wide input voltage range.

It can be readily seen that the advantages of 2-phase operation are not limited to a narrow operating range, but in fact extend over a wide region. A good rule of thumb for most applications is that 2-phase operation will reduce the input capacitor requirement to that for just one channel operating at maximum current and 50% duty cycle.

A final question: If 2-phase operation offers such an advantage over 1-phase operation for dual switching regulators, why hasn’t it been done before? The answer is

that, while simple in concept, it is hard to implement. Constant-frequency, current mode switching regulators require an oscillator-derived “slope compensation” signal to allow stable operation of each regulator at over 50% duty cycle. This signal is relatively easy to derive in 1-phase dual switching regulators, but required the development of a new and proprietary technique to allow 2-phase operation. In addition, isolation between the two channels becomes more critical with 2-phase operation because switch transitions in one channel could potentially disrupt the operation of the other channel.

The LTC1628 is proof that these hurdles have been surmounted. The new device offers unique advantages for the ever expanding number of high efficiency power supplies required in portable electronics.

#### DC236 Operation

The LTC1628 switching regulator performs high efficiency DC/DC voltage conversion while maintaining constant frequency over a wide range of load current, using a 2-phase current mode architecture. The 2-phase approach results in 75% less power loss (and heat generated) in the input source resistance because dissipated power is proportional to the square of the RMS current. The input ripple frequency is also double the individual controller’s switching frequency, further reducing the input capacitance requirement. Reducing peak currents and doubling the radiated frequency significantly reduces EMI related problems.

The internal oscillator frequency is set by the voltage applied to the FREQSET pin. The FREQ jumper on the demonstration board allows selection of three different voltages: 0V, 1.2V when the jumper is left off, and 5V. The internal oscillator will run at 130kHz, 200kHz and 300kHz respectively. The frequency can be continuously varied over a 130kHz to 300kHz range by applying an external 0V to 2.4V to the FREQSET pin.

High efficiency is made possible by selecting either of two low current modes: 1) Burst Mode operation for maximum efficiency and 2) constant frequency, burst disable mode for slightly less efficiency. Constant frequency is desirable in applications requiring minimal electrical noise.

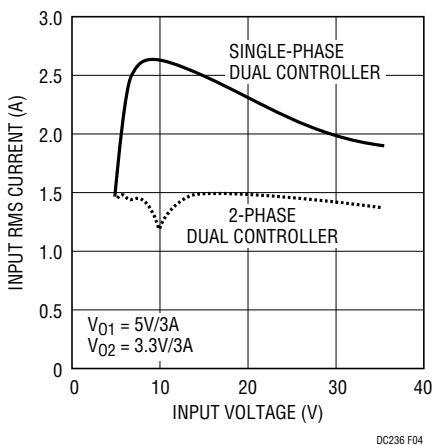

Figure 4. RMS Input Current Comparison

## OPERATION

Burst Mode operation allows the output MOSFETs to “sleep” between several PWM switching cycle periods of normal MOSFET activity. The current loss due to charging the MOSFETs is not present during these “sleeping” periods. Hysteretic output voltage detection results in a slight increase of output voltage ripple during Burst Mode operation. Bursting starts at approximately 20% of maximum designed load current.

The burst disable mode allows heavily discontinuous, constant-frequency operation down to approximately 1% of maximum designed load current. This mode results in the elimination of switching frequency subharmonics over 99% of the output load range. Switching cycles start to be dropped at approximately 1% of maximum designed load current in order to maintain proper output voltage.

The FCB input pin allows the selection of the low current operating mode of both switching regulator controllers. Burst disable mode is enabled when the FCB pin is tied to  $INTV_{CC}$ .

Tying the FCB pin to ground potential forces the controller into PWM or forced continuous mode. In forced continuous mode, the output MOSFETs are always driven, regardless of output loading conditions. Operating in this mode allows the switching regulator to source or sink current—but be careful: when the output stage sinks current, power is transferred back into the input supply terminals and the input voltage rises.

Burst Mode operation is enabled when the voltage applied to the FCB pin is less than  $(INTV_{CC} - 0.8V)$  or if the pin is left open. A comparator, having a precision 0.8V threshold, allows the pin to be used to regulate a secondary winding on the switching regulator’s output. A small amount of hysteresis is included in the design of the comparator to facilitate clean secondary operation. When the resistively divided secondary output voltage falls below the 0.8V threshold, the controller operates in the forced continuous operating mode for as long as it takes to bring the secondary voltage above the  $0.8V +$  hysteresis level.

The FLTCPL pin allows coupling between the two controllers in several situations. The controllers will act

independently when FLTCPL is grounded. When the pin is tied to  $INTV_{CC}$  the following operations result:

1. When the FCB input voltage falls below its 0.8V threshold, both controllers go into a forced continuous operating mode.
2. When either controller latches off due to an overload condition (or short circuit), the other channel will be latched off as well. Either the STBYMD mode pin or both RUN/SS1 and RUN/SS2 pins need to be pulled to ground in order to unlatch this condition. The STBYMD mode pin internally pulls down both RUN/SS pins when grounded. If the latches are defeated through the use of an external pull-up current, neither latch will be activated.

The STBYMD PC board input is tied to the STBYMD IC pin. Pulling the STBYMD IC pin up with greater than  $5\mu A$  to the input supply turns on the internal 5V  $INTV_{CC}$  and the 3.3V LDO regulators when neither of the two switching regulator controllers is turned on. The 5V  $INTV_{CC}$  regulator will supply up to  $50mA_{RMS}$  and the 3.3V LDO will supply up to  $25mA_{RMS}$ . Peak currents may be significantly higher but internal power dissipation must be calculated to guarantee that die temperature does not exceed the data sheet specifications.

The demonstration board is shipped in a standard configuration of 5V/3.3V but may be modified to produce output voltages as low as 0.8V. Modifications will require changes to the resistive voltage feedback divider and, in some cases, the  $I_{TH}$  pin compensation components.

Efficiency measurement depends on the operating conditions of both regulators and must be performed thoughtfully and carefully. The maximum efficiency will occur with the minimum required circuitry operating on an individual regulator. Since there is much common circuitry operating in the IC when both regulators are running, overall efficiency numbers will actually increase when the two switching regulators are active. The increase is not significant at high output currents but can become very significant at low output currents, when the IC supply current becomes an appreciable part of the total input supply current.

## OPERATION

Refer to the LTC1628 data sheet for further information on the internal operation and functionality descriptions of the IC.

### Overcurrent and Overvoltage Protection

The RUN/SS capacitor,  $C_{SS}$ , is used initially to turn on and limit the inrush current of the controller. After the controller has been started and given adequate time to charge the output capacitor and provide full load current,  $C_{SS}$  is used as a short-circuit time-out circuit. If the output voltage falls to less than 70% of its nominal output voltage,  $C_{SS}$  begins discharging on the assumption that the output is in an overcurrent and/or short-circuit condition. If the condition lasts for a long enough period as determined by the size of  $C_{SS}$ , the controller will be shut down until the RUN/SS pin voltage is recycled. This built-in latch-off can be overridden by providing  $>5\mu\text{A}$  pull-up at a compliance of 4V to the RUN/SS pin. This current shortens the soft start period but also prevents net discharge of the RUN/SS capacitor during an overcurrent and/or short-circuit condition. Foldback current limiting is activated when the output voltage falls below 70% of its nominal level, whether or not the short-circuit latch-off circuit is enabled.

The output is protected from overvoltage by a “soft latch.” When the output voltage exceeds the regulation value by more than 7.5%, the synchronous MOSFET turns on and remains on for as long as the overvoltage condition is present. If the output voltage returns to a safe level, normal operation resumes. This self-resetting action prevents “nuisance trips” due to momentary transients and eliminates the need for the Schottky diode that is necessary with conventional OVP to prevent  $V_{OUT}$  reversal.

### DC236 Physical Design

The demonstration board is manufactured using a typical 4-layer copper PC board. The outside layers are 2 oz copper and the inside layers are 1oz copper. The board is designed to use the minimum number of external components but has a few components added to facilitate optional IC configurations. These added components will not be required in a final design. These components include R9, R10, R12 and C19 to C21. Other components that may not be necessary depending upon the particular

design include C9, C10, C13, C14, C18 and R11. Certain components may be larger than specific applications will require. The output capacitance and the inductance values selected are larger than may be required in order to accommodate the very wide operating frequency range (130kHz to 300kHz) capability of the demonstration board. Output capacitance as low as  $47\mu\text{F}$  and inductance values as low as several microhenries will work well at the higher frequencies. The 2-phase controller technique significantly reduces the capacity and ESR requirements of the input capacitor when compared to a 1-phase approach. The dual output MOSFETs used in the design reduce the overall size of the design and take advantage of an extended copper foil trace to help dissipate power on the board. The Schottky diodes, D1 and D2, can also be removed to reduce system cost but will decrease efficiency slightly.

### Active Loads—Beware!

Beware of Active Loads. They are convenient but problematic. Some active loads do not turn on until the applied voltage rises above 0.1V to 0.8V. The turn-on may be delayed as well. Under these conditions, a switching regulator with soft start may appear to start up and then shut down before eventually reaching the correct output voltage. What actually happens is as follows: at switching regulator turn-on, the output voltage is below the active load’s turn-on requirements. The switching regulator’s output rises to the correct output voltage level due to the inherent delay in the active load. The active load turns on after its internal delay and now pulls down the switching regulator’s output because the switcher is in its soft start interval. The switching regulator’s output may come up at some later time when the soft start interval has passed.

A switching regulator with foldback current limit will also have difficulty with the unrealistic I-V characteristic of the active load. Foldback current limiting will reduce the output current available as the output voltage drops below a threshold level (this level is 70% of nominal  $V_{OUT}$  for the LTC1628). This reduction in available output current will result in the active load immediately pulling down the output because the active load’s current demand remains constant as the output voltage decreases. Most actual



## OPERATION

loads do not behave like the active load's I-V characteristics. Actual loads normally have  $V_{IN} \cdot C \cdot f$  dependency where C is internal chip capacitance and f is the frequency of operation. To alleviate the active load problem during testing, the active load should be initially programmed to a much lower current value until the switching regulator's soft start interval has passed and then reprogrammed to the higher level. The switching regulator will supply the increased current required according to the transient response behavior of the design. Sufficient output capacitance is needed to accommodate the current step during the transient period, keeping the output voltage at or above the foldback threshold of 70%.

### PC Board Layout Hints

Switching power supply printed circuit layouts are certainly among the most difficult analog circuits to design. The following suggestions will help.

The input circuit, including the external switching MOSFETs, input capacitor(s) and Schottky diode(s) all have fast voltage and current transitions associated with them. These components and the radiated fields (electrostatic and/or electromagnetic) *must* be kept away from the very sensitive control circuitry and loop compensation components required for a current mode switching regulator.

The electrostatic or capacitive coupling problems can be reduced by increasing the distance from the very large or very fast moving voltage signals. The signal points that cause problems generally include the switch node, any secondary flyback winding voltage and any nodes that also move with these nodes. The switch, MOSFET gate and boost nodes move between  $V_{IN}$  and PGND during each cycle, with less than a 50ns transition time. Secondary flyback windings produce an AC signal component of  $-V_{IN}$  times the turns ratio of the transformer and also have a similar <50ns transition time. The control input signals need to have less than a few millivolts of noise in order for the regulator to perform properly. A rough calculation shows that 80dB of isolation at 2MHz is required from the switch node for low noise switcher operation. The situation is worsened by a factor of the turns ratio for any

secondary flyback winding. Keep these switch node-related PC traces small and away from the "quiet" side of the IC (not just above and below each other on the opposite side of the board).

The electromagnetic or current loop-induced feedback problems can be minimized by keeping the high AC current (transmitter) paths *and* the feedback circuit (receiver) path small and/or short. Maxwell's equations are at work here, trying to disrupt our clean flow of current and voltage information from the output back to the controller input. It is crucial to understand and minimize the susceptibility of the control input stage as well as the more obvious reduction of radiation from the high current output stage(s). An inductive transmitter depends upon the frequency, current amplitude and the size of the current loop to determine the radiation characteristic of the generated field. The current levels are set in the output stage once the input voltage, output voltage and inductor value(s) have been selected. The frequency is set by the output stage transition times. The only parameter over which we have some control is the size of the antenna we create on the PC board, i.e., the loop. A loop is formed with the input capacitance, the top MOSFET, the Schottky diode and the path from the Schottky diode's ground connection to the input capacitor's ground connection. A second path is formed when a secondary winding is used, comprising the secondary output capacitor, the secondary winding and the rectifier diode or switching MOSFET (in the case of a synchronous approach). These loops should be kept as small and tightly packed as possible in order to minimize their "far field" radiation effects. The radiated field produced is picked up by the current comparator input filter circuit(s), as well as by the voltage feedback circuit(s). The current comparator's filter capacitor, placed across the sense pins, attenuates the radiated current signal. It is important to place this capacitor immediately adjacent to the IC SENSE pins. The voltage sensing input(s) minimize the inductive pickup component by using an input capacitance filter to SGND. The capacitors in both cases serve to integrate the induced current, reducing the susceptibility to both the loop radiated magnetic fields and the transformer or inductor leakage fields.

### OPERATION

The PGND-SGND tie point for the LTC1628 switching regulator controllers is optimized by connecting the grounds directly under the IC, creating a close surface grounding plane.

The capacitor on INTV<sub>CC</sub> acts as a reservoir to supply the high transient currents to the bottom gates *and* to recharge the boost capacitor. This capacitor should be a 10 $\mu$ F ceramic capacitor or a 1 $\mu$ F ceramic capacitor in parallel with a 4.7 $\mu$ F tantalum capacitor. The ceramic capacitor must be placed as close as possible to the INTV<sub>CC</sub> and PGND pins of the IC. Peak currents exceed 1A when charging the gates of the bottom MOSFETs.

The traces that sense the voltage across the current-sensing resistor can be long but should run parallel to each other and be spaced with the minimum separation allowed in order to experience the same electrostatic and electromagnetic fields from radiating sources. The traces should be wider than minimum if they are long in order to minimize self-inductance. Keep these traces on a PC board plane farthest from the high current and large switching voltage plane. Any filtering resistors in series with these traces should be placed close to the IC rather than close to radiating nodes, such as the switch and boost nodes.

### PCB LAYOUT AND FILM

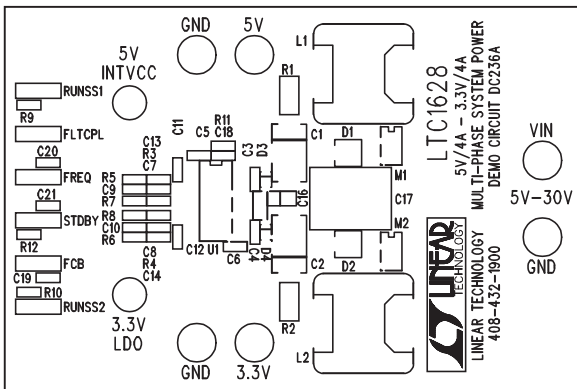

Component Side Silkscreen

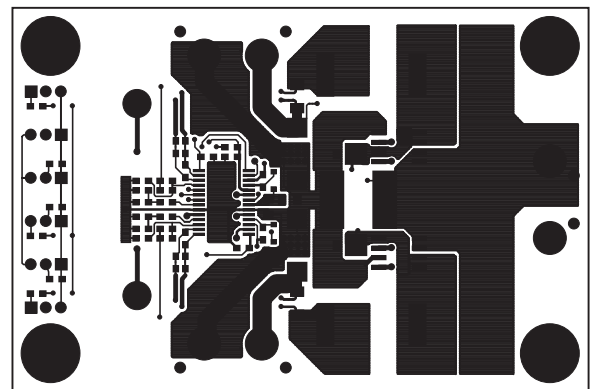

Copper Layer 1 Top

## PCB LAYOUT AND FILM

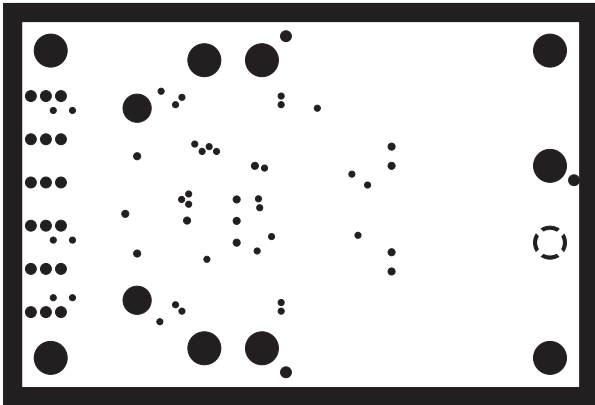

Copper Layer 2

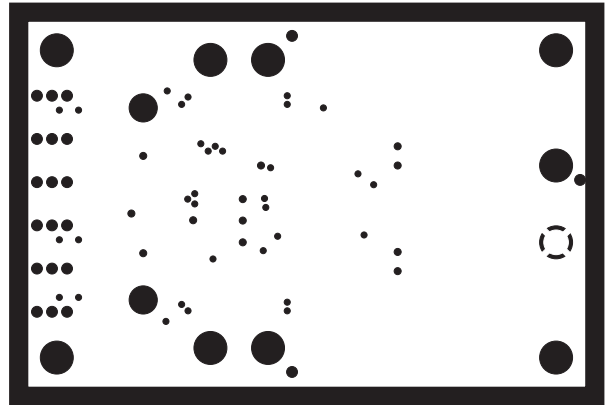

Copper Layer 3

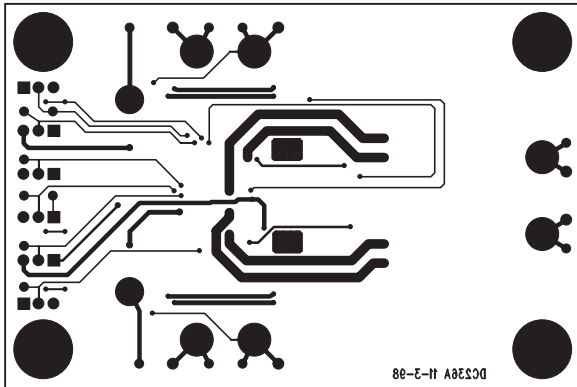

Copper Layer 4

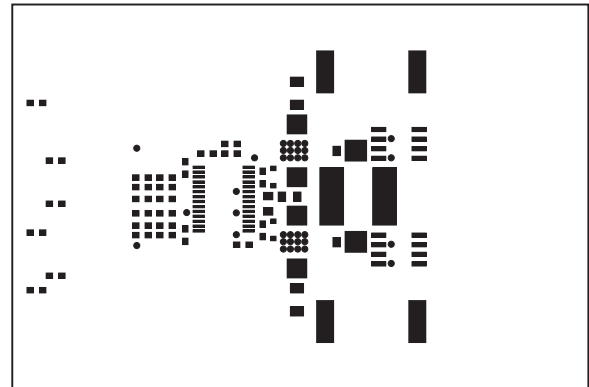

Paste Mask

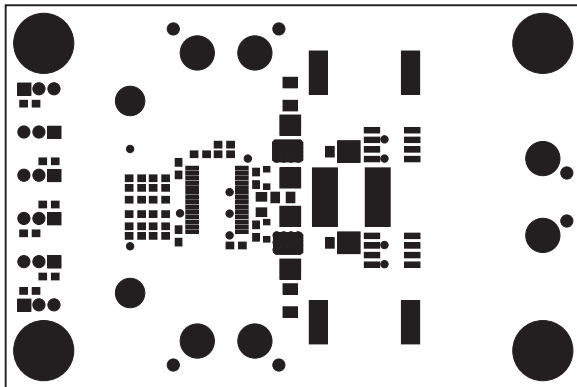

Solder Mask Top

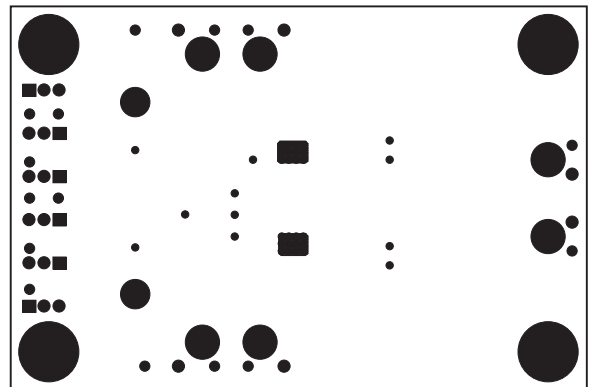

Solder Mask Bottom

**PC FAB DRAWING**

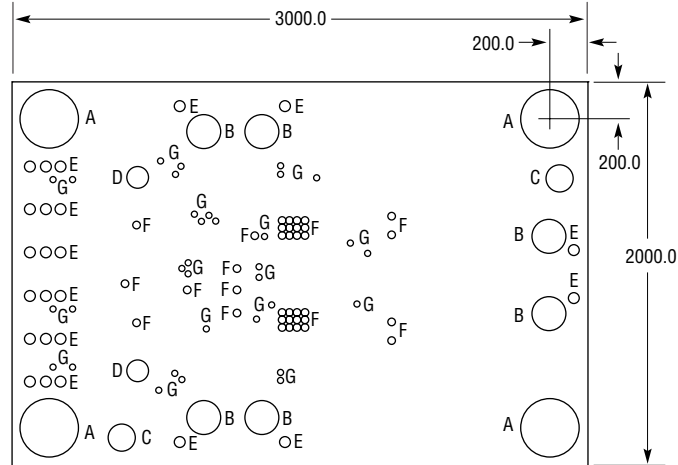

**HOLE CHART**

SYMBOL	DIAMETER	NUMBER OF HOLES	PLATED
A	120	4	YES
B	94	6	YES
C	70	2	NO
D	64	2	YES
E	30	24	YES
F	15	36	YES
G	10	33	YES
TOTAL		107	

**NOTES: UNLESS OTHERWISE SPECIFIED**

1. ALL DIMENSIONS ARE IN MILS,  $\pm 3$
2. FINISHED HOLE SIZES ARE  $\pm 3$
3. FINISHED MATERIAL IS FR4, 62-THICK, 2 OZ Cu, 4-LAYERS
4. PLATED HOLE WALL THICKNESS IS 1MIL MINIMUM
5. INTERNAL LAYERS ARE 1 OZ Cu

# Mouser Electronics

Authorized Distributor

Click to View Pricing, Inventory, Delivery & Lifecycle Information:

[Analog Devices Inc.:](#)

[DC236C-A](#) [DC236C-C](#)