



# STD3NM60N

## N-channel 600 V, 1.6 $\Omega$ , 3.3 A, MDmesh™ II Power MOSFET in DPAK package

Datasheet — preliminary data

### Features

Order codes	V <sub>DSS</sub> @T <sub>J</sub> max	R <sub>DS(on)</sub> max.	I <sub>D</sub>
STD3NM60N	650 V	< 1.8 $\Omega$	3.3 A

- 100% avalanche tested
- Low input capacitance and gate charge
- Low gate input resistance

### Applications

- Switching applications

### Description

This device is an N-channel Power MOSFET developed using the second generation of MDmesh™ technology. This revolutionary Power MOSFET associates a vertical structure to the company's strip layout to yield one of the world's lowest on-resistance and gate charge. It is therefore suitable for the most demanding high efficiency converters.

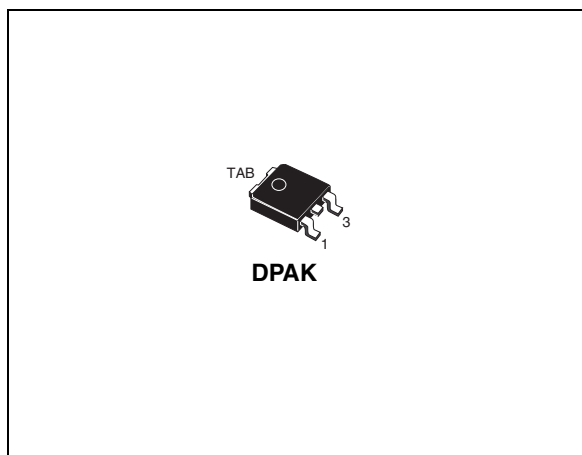

Figure 1. Internal schematic diagram

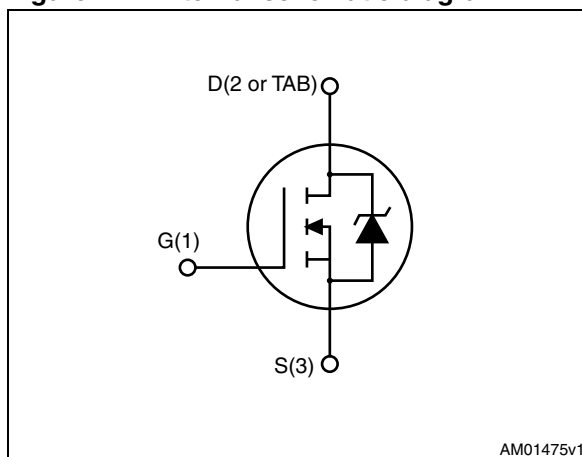

Table 1. Device summary

Order codes	Marking	Package	Packaging
STD3NM60N	3NM60N	DPAK	Tape and reel

# Contents

<b>1</b>	<b>Electrical ratings</b> .....	<b>3</b>
<b>2</b>	<b>Electrical characteristics</b> .....	<b>4</b>
	2.1 Electrical characteristics (curves) .....	6
<b>3</b>	<b>Test circuits</b> .....	<b>8</b>
<b>4</b>	<b>Package mechanical data</b> .....	<b>9</b>
<b>5</b>	<b>Packaging mechanical data</b> .....	<b>12</b>
<b>6</b>	<b>Revision history</b> .....	<b>14</b>

# 1 Electrical ratings

**Table 2. Absolute maximum ratings**

Symbol	Parameter	Value	Unit
$V_{GS}$	Gate- source voltage	$\pm 25$	V
$I_D$	Drain current (continuous) at $T_C = 25\text{ }^\circ\text{C}$	3.3	A
$I_D$	Drain current (continuous) at $T_C = 100\text{ }^\circ\text{C}$	2.5	A
$I_{DM}^{(1)}$	Drain current (pulsed)	13	A
$P_{TOT}$	Total dissipation at $T_C = 25\text{ }^\circ\text{C}$	50	W
$dv/dt^{(2)}$	Peak diode recovery voltage slope	15	V/ns
$T_J$ $T_{stg}$	Operating junction temperature Storage temperature	- 55 to 150	$^\circ\text{C}$

1. Pulse width limited by safe operating area.

2.  $I_{SD} \leq 3.3\text{ A}$ ,  $di/dt \leq 400\text{ A}/\mu\text{s}$ ,  $V_{DS\text{ peak}} \leq V_{(BR)DSS}$ ,  $V_{DD} = 80\% V_{(BR)DSS}$ .

**Table 3. Thermal data**

Symbol	Parameter	Value	Unit
$R_{thj-case}$	Thermal resistance junction-case max	2.5	$^\circ\text{C}/\text{W}$
$R_{thj-pcb}$	Thermal resistance junction-pcb max	50	$^\circ\text{C}/\text{W}$

**Table 4. Avalanche characteristics**

Symbol	Parameter	Value	Unit
$I_{AR}$	Avalanche current, repetitive or not-repetitive (pulse width limited by $T_J$ max)	1	A
EAS	Single pulse avalanche energy (starting $T_J=25\text{ }^\circ\text{C}$ , $I_D=I_{AR}$ , $V_{DD}=50\text{ V}$ )	86	mJ

## 2 Electrical characteristics

(T<sub>case</sub> =25 °C unless otherwise specified)

**Table 5. On /off states**

Symbol	Parameter	Test conditions	Min.	Typ.	Max.	Unit
V <sub>(BR)DSS</sub>	Drain-source breakdown voltage	I <sub>D</sub> = 1 mA, V <sub>GS</sub> = 0	600			V
I <sub>DSS</sub>	Zero gate voltage drain current (V <sub>GS</sub> = 0)	V <sub>DS</sub> = 600 V V <sub>DS</sub> = 600 V, T <sub>C</sub> =125 °C			1 100	μA μA
I <sub>GSS</sub>	Gate-body leakage current (V <sub>DS</sub> = 0)	V <sub>GS</sub> = ± 25 V; V <sub>DS</sub> =0			±100	nA
V <sub>GS(th)</sub>	Gate threshold voltage	V <sub>DS</sub> = V <sub>GS</sub> , I <sub>D</sub> = 250 μA	2	3	4	V
R <sub>DS(on)</sub>	Static drain-source on-resistance	V <sub>GS</sub> = 10 V, I <sub>D</sub> = 1.65A		1.6	1.8	Ω

**Table 6. Dynamic**

Symbol	Parameter	Test conditions	Min.	Typ.	Max.	Unit
C <sub>iss</sub>	Input capacitance	V <sub>DS</sub> = 50 V, f = 1 MHz, V <sub>GS</sub> = 0	-	188	-	pF
C <sub>oss</sub>	Output capacitance			12.8		pF
C <sub>rss</sub>	Reverse transfer capacitance			1.1		pF
C <sub>oss(tr)</sub> <sup>(1)</sup>	Output capacitance time related	V <sub>DS</sub> = 0, V <sub>GS</sub> = 0	-	96.8	-	pF
R <sub>g</sub>	Gate input resistance	f=1 MHz open drain	-	6	-	Ω
Q <sub>g</sub>	Total gate charge	V <sub>DD</sub> = 480 V, I <sub>D</sub> = 3.3A, V <sub>GS</sub> = 10 V <i>(see Figure 15)</i>	-	9.5	-	nC
Q <sub>gs</sub>	Gate-source charge			2		nC
Q <sub>gd</sub>	Gate-drain charge			5		nC

1. Time related is defined as a constant equivalent capacitance giving the same charging time as C<sub>oss</sub> when V<sub>DS</sub> increases from 0 to 80% V<sub>DSS</sub>.

**Table 7. Switching times**

Symbol	Parameter	Test conditions	Min.	Typ.	Max	Unit
$t_{d(on)}$	Turn-on delay time	$V_{DD} = 300\text{ V}$ , $I_D = 1.65\text{ A}$ , $R_G = 4.7\ \Omega$ , $V_{GS} = 10\text{ V}$ <i>(see Figure 14)</i>		6		ns
$t_r$	Rise time		-	9.5	-	ns
$t_{d(off)}$	Turn-off-delay time				23	ns
$t_f$	Fall time				31	ns

**Table 8. Source drain diode**

Symbol	Parameter	Test conditions	Min.	Typ.	Max	Unit
$I_{SD}$	Source-drain current				3.3	A
$I_{SDM}^{(1)}$	Source-drain current (pulsed)		-		13.2	A
$V_{SD}^{(2)}$	Forward on voltage	$I_{SD} = 3.3\text{ A}$ , $V_{GS} = 0$	-		1.6	V
$t_{rr}$	Reverse recovery time	$I_{SD} = 3.3\text{ A}$ , $di/dt = 100\text{ A}/\mu\text{s}$ $V_{DD} = 60\text{ V}$ <i>(see Figure 16)</i>		200		ns
$Q_{rr}$	Reverse recovery charge		-	910		nC
$I_{RRM}$	Reverse recovery current				9.1	A
$t_{rr}$	Reverse recovery time	$I_{SD} = 3.3\text{ A}$ , $di/dt = 100\text{ A}/\mu\text{s}$ $V_{DD} = 60\text{ V}$ , $T_J = 150\text{ }^\circ\text{C}$ <i>(see Figure 16)</i>		236		ns
$Q_{rr}$	Reverse recovery charge		-	1073		nC
$I_{RRM}$	Reverse recovery current				9.1	A

1. Pulse width limited by safe operating area
2. Pulsed: pulse duration = 300  $\mu\text{s}$ , duty cycle 1.5%

## 2.1 Electrical characteristics (curves)

Figure 2. Safe operating area

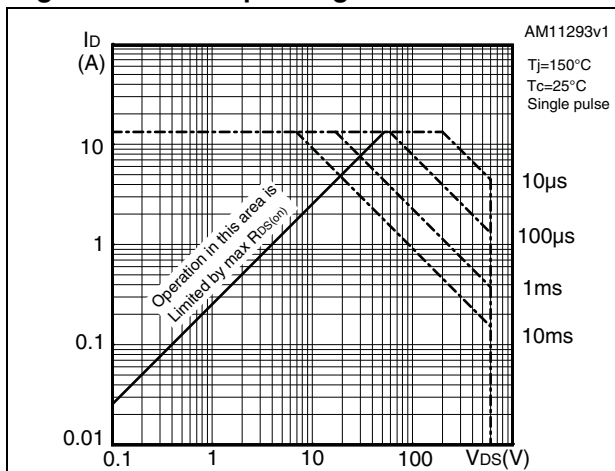

Figure 3. Thermal impedance

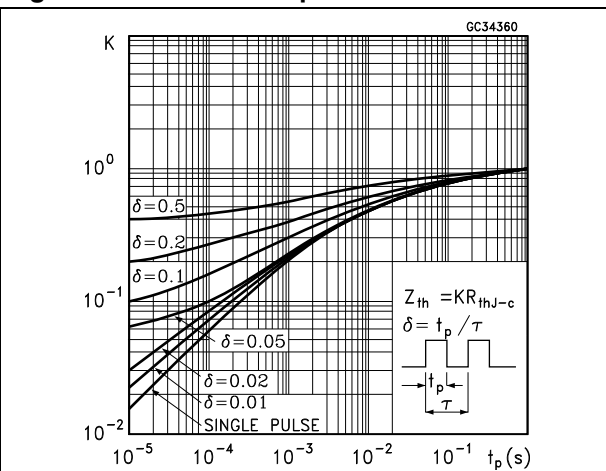

Figure 4. Output characteristics

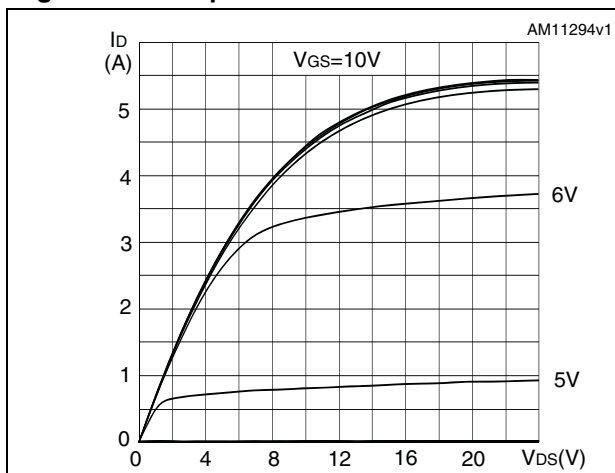

Figure 5. Transfer characteristics

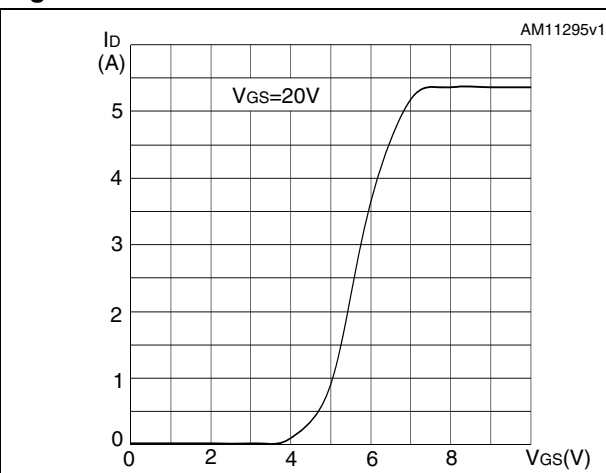

Figure 6. Gate charge vs gate-source voltage

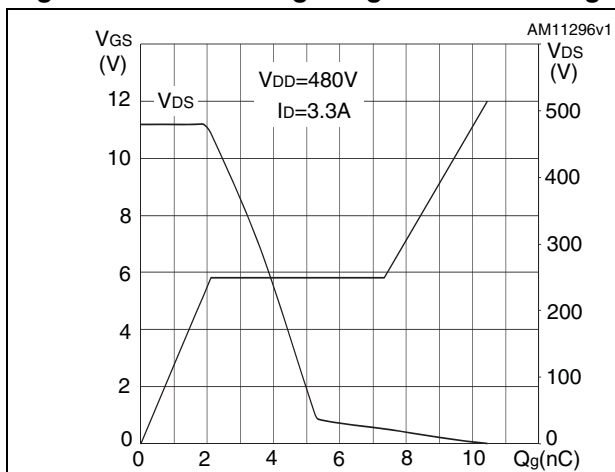

Figure 7. Static drain-source on-resistance

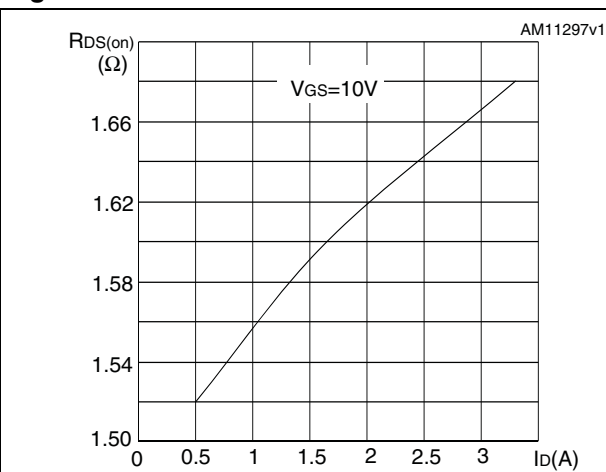

Figure 8. Capacitance variations

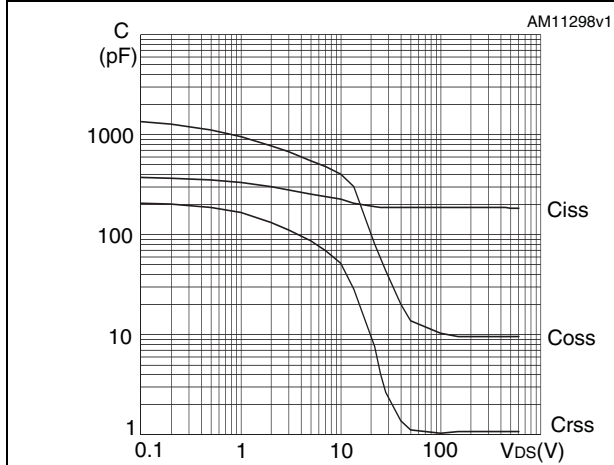

Figure 9. Output capacitance stored energy

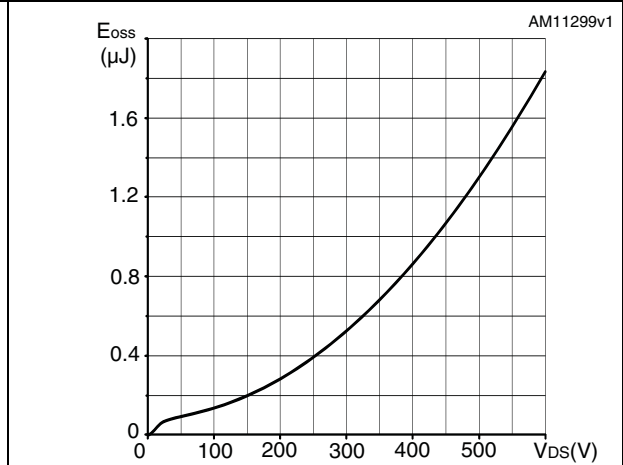

Figure 10. Normalized gate threshold voltage vs. temperature

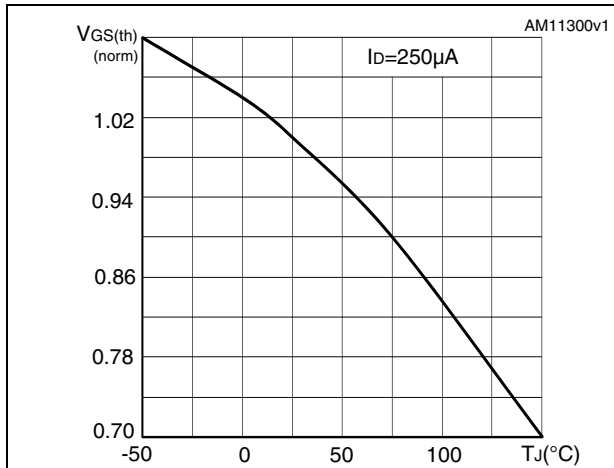

Figure 11. Normalized on-resistance vs. temperature

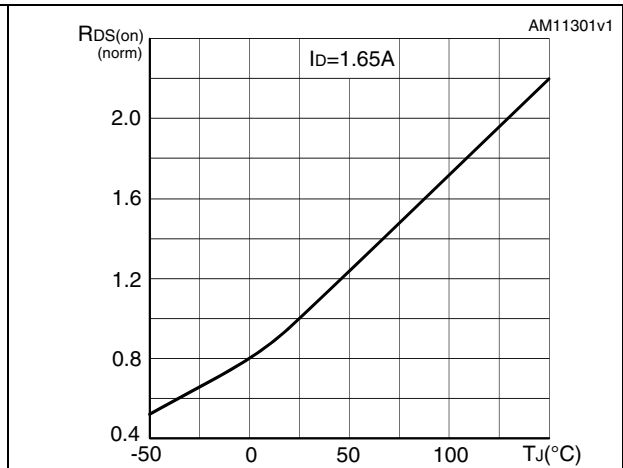

Figure 12. Source-drain diode forward characteristics

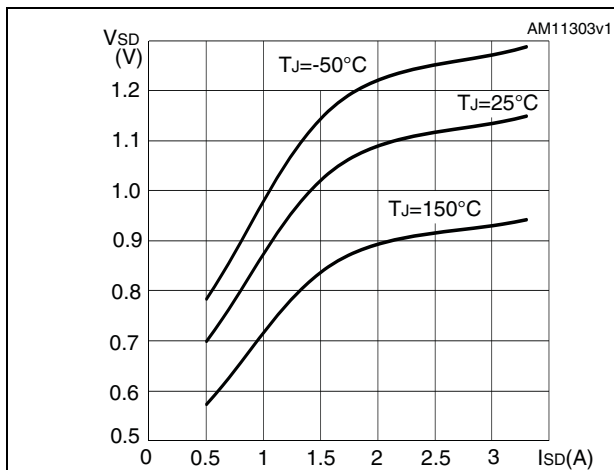
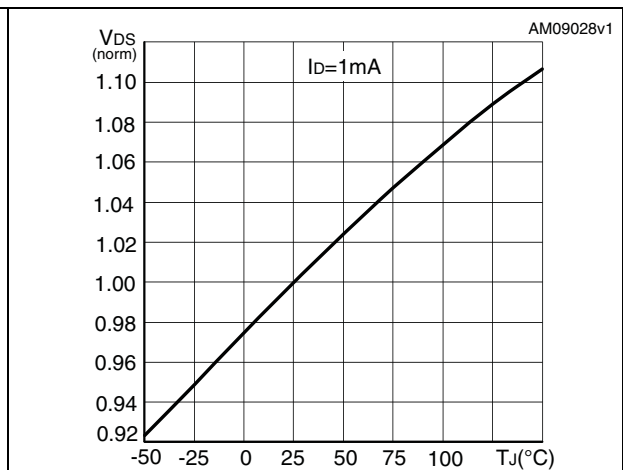

Figure 13. Normalized VDS vs. temperature



### 3 Test circuits

**Figure 14. Switching times test circuit for resistive load**



AM01468v1

**Figure 15. Gate charge test circuit**



AM01469v1

**Figure 16. Test circuit for inductive load switching and diode recovery times**



AM01470v1

**Figure 17. Unclamped inductive load test circuit**



AM01471v1

**Figure 18. Unclamped inductive waveform**

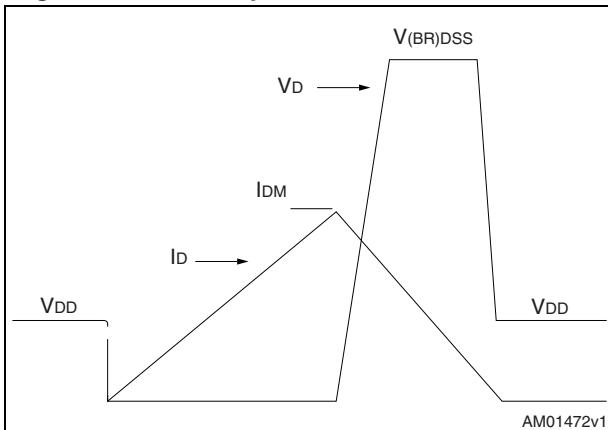

AM01472v1

**Figure 19. Switching time waveform**

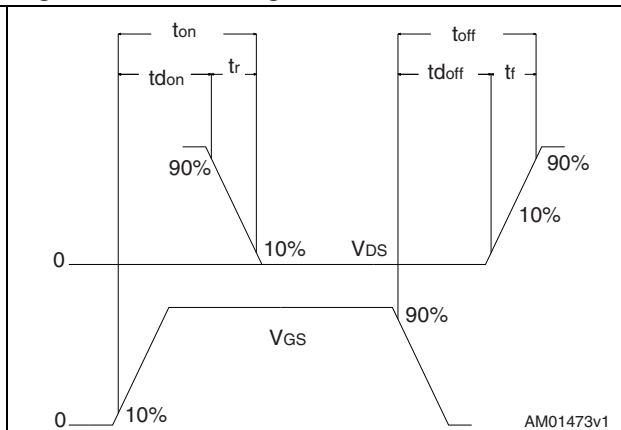

AM01473v1



## 4 Package mechanical data

In order to meet environmental requirements, ST offers these devices in different grades of ECOPACK<sup>®</sup> packages, depending on their level of environmental compliance. ECOPACK<sup>®</sup> specifications, grade definitions and product status are available at: [www.st.com](http://www.st.com). ECOPACK is an ST trademark.

Table 9. DPAK (TO-252) mechanical data

Dim.	mm		
	Min.	Typ.	Max.
A	2.20		2.40
A1	0.90		1.10
A2	0.03		0.23
b	0.64		0.90
b4	5.20		5.40
c	0.45		0.60
c2	0.48		0.60
D	6.00		6.20
D1		5.10	
E	6.40		6.60
E1		4.70	
e		2.28	
e1	4.40		4.60
H	9.35		10.10
L	1		1.50
L1		2.80	
L2		0.80	
L4	0.60		1
R		0.20	
V2	0°		8°

Figure 20. DPAK (TO-252) drawing

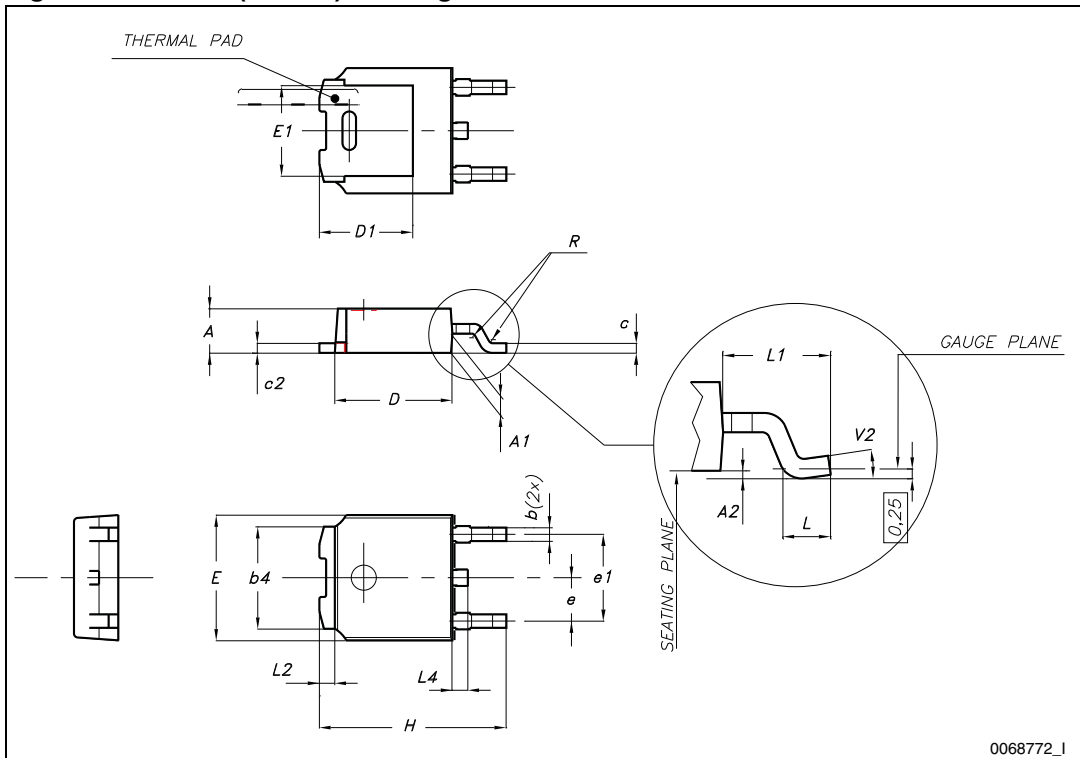
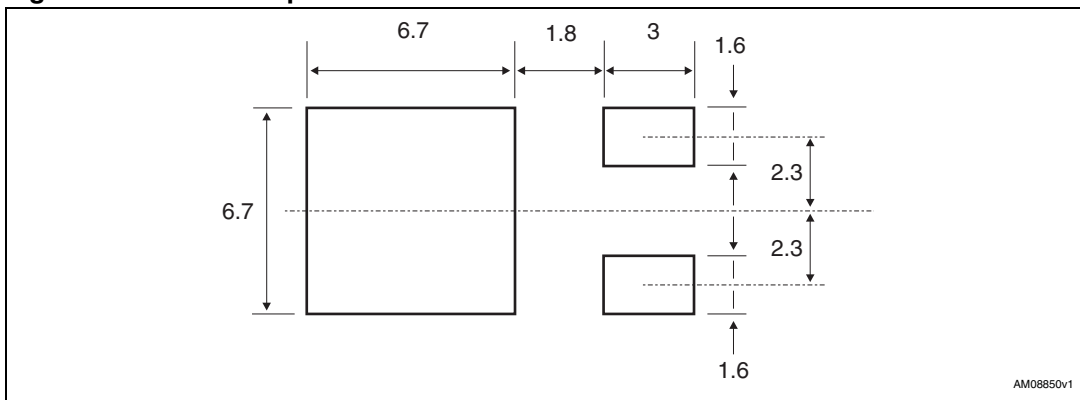

Figure 21. DPAK footprint<sup>(a)</sup>



a. All dimensions are in millimeters

## 5 Packaging mechanical data

Table 10. DPAK (TO-252) tape and reel mechanical data

Tape			Reel		
Dim.	mm		Dim.	mm	
	Min.	Max.		Min.	Max.
A0	6.8	7	A		330
B0	10.4	10.6	B	1.5	
B1		12.1	C	12.8	13.2
D	1.5	1.6	D	20.2	
D1	1.5		G	16.4	18.4
E	1.65	1.85	N	50	
F	7.4	7.6	T		22.4
K0	2.55	2.75			
P0	3.9	4.1	Base qty.		2500
P1	7.9	8.1	Bulk qty.		2500
P2	1.9	2.1			
R	40				
T	0.25	0.35			
W	15.7	16.3			

Figure 22. Tape for DPAK (TO-252)

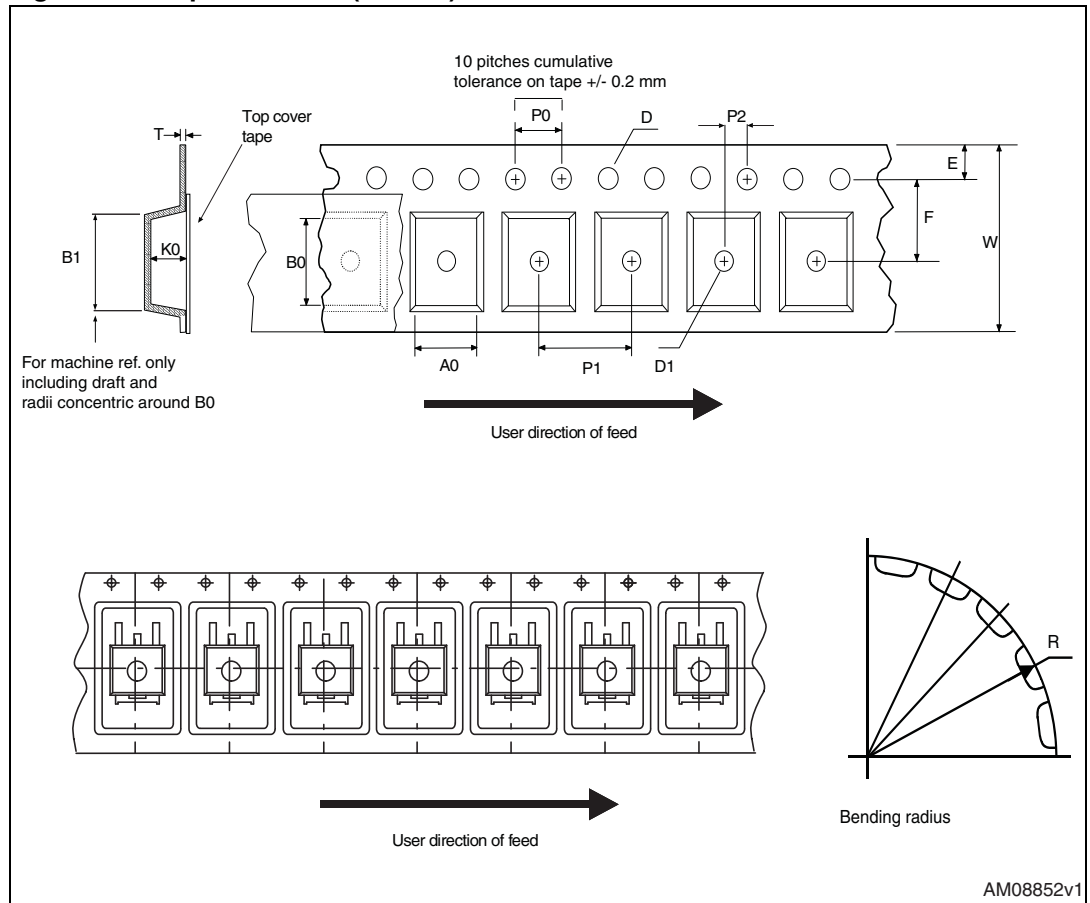
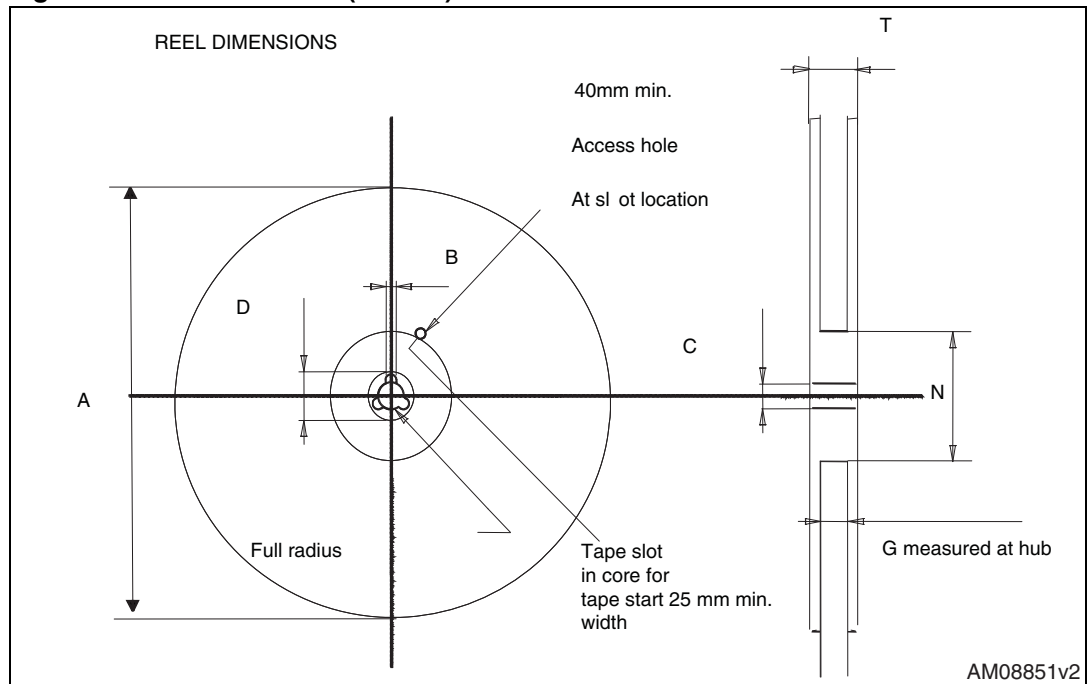

Figure 23. Reel for DPAK (TO-252)



## 6 Revision history

Table 11. Document revision history

Date	Revision	Changes
10-May-2012	1	First release

**Please Read Carefully:**

Information in this document is provided solely in connection with ST products. STMicroelectronics NV and its subsidiaries ("ST") reserve the right to make changes, corrections, modifications or improvements, to this document, and the products and services described herein at any time, without notice.

All ST products are sold pursuant to ST's terms and conditions of sale.

Purchasers are solely responsible for the choice, selection and use of the ST products and services described herein, and ST assumes no liability whatsoever relating to the choice, selection or use of the ST products and services described herein.

No license, express or implied, by estoppel or otherwise, to any intellectual property rights is granted under this document. If any part of this document refers to any third party products or services it shall not be deemed a license grant by ST for the use of such third party products or services, or any intellectual property contained therein or considered as a warranty covering the use in any manner whatsoever of such third party products or services or any intellectual property contained therein.

**UNLESS OTHERWISE SET FORTH IN ST'S TERMS AND CONDITIONS OF SALE ST DISCLAIMS ANY EXPRESS OR IMPLIED WARRANTY WITH RESPECT TO THE USE AND/OR SALE OF ST PRODUCTS INCLUDING WITHOUT LIMITATION IMPLIED WARRANTIES OF MERCHANTABILITY, FITNESS FOR A PARTICULAR PURPOSE (AND THEIR EQUIVALENTS UNDER THE LAWS OF ANY JURISDICTION), OR INFRINGEMENT OF ANY PATENT, COPYRIGHT OR OTHER INTELLECTUAL PROPERTY RIGHT.**

**UNLESS EXPRESSLY APPROVED IN WRITING BY TWO AUTHORIZED ST REPRESENTATIVES, ST PRODUCTS ARE NOT RECOMMENDED, AUTHORIZED OR WARRANTED FOR USE IN MILITARY, AIR CRAFT, SPACE, LIFE SAVING, OR LIFE SUSTAINING APPLICATIONS, NOR IN PRODUCTS OR SYSTEMS WHERE FAILURE OR MALFUNCTION MAY RESULT IN PERSONAL INJURY, DEATH, OR SEVERE PROPERTY OR ENVIRONMENTAL DAMAGE. ST PRODUCTS WHICH ARE NOT SPECIFIED AS "AUTOMOTIVE GRADE" MAY ONLY BE USED IN AUTOMOTIVE APPLICATIONS AT USER'S OWN RISK.**

Resale of ST products with provisions different from the statements and/or technical features set forth in this document shall immediately void any warranty granted by ST for the ST product or service described herein and shall not create or extend in any manner whatsoever, any liability of ST.

ST and the ST logo are trademarks or registered trademarks of ST in various countries.

Information in this document supersedes and replaces all information previously supplied.

The ST logo is a registered trademark of STMicroelectronics. All other names are the property of their respective owners.

© 2012 STMicroelectronics - All rights reserved

STMicroelectronics group of companies

Australia - Belgium - Brazil - Canada - China - Czech Republic - Finland - France - Germany - Hong Kong - India - Israel - Italy - Japan - Malaysia - Malta - Morocco - Philippines - Singapore - Spain - Sweden - Switzerland - United Kingdom - United States of America

[www.st.com](http://www.st.com)



# Mouser Electronics

Authorized Distributor

Click to View Pricing, Inventory, Delivery & Lifecycle Information:

[STMicroelectronics:](#)

[STD3NM60N](#)