

DO NOT SCALE FROM THIS PRINT

- NOTES:
 1. **FILL ROWS 3, 4, 7, 8 ONLY NOT AVAILABLE AS STANDARD. VITA 57 CONNECTOR.**
 2. NOTE DELETED.
 3. $\text{\textcircled{C}}$ REPRESENTS A CRITICAL DIMENSION.
 4. MINIMUM PUSHOUT FORCE: 0.50 LBS.
 5. ATTACH LABEL "SEAX-0001" TO EACH TAPE & REEL PACKAGE.
 6. MAXIMUM ROW TO ROW VARIATION .003[0.08], MEASURED FIRST & LAST POSITIONS ONLY, ALL ROWS.
 7. DIMENSION C8 MUST BE MEASURED IN THE FOUR OUTSIDE CORNERS USING INSPECTION FIXTURE AT-1817-836-2, USE CO-AU-WI-2003-M FOR PROCESS.
 8. PARTS TO BE PACKAGED IN TAPE & REEL.

ANY REV MADE TO THIS PRINT MUST HAVE AN UPDATED MKT PRINT

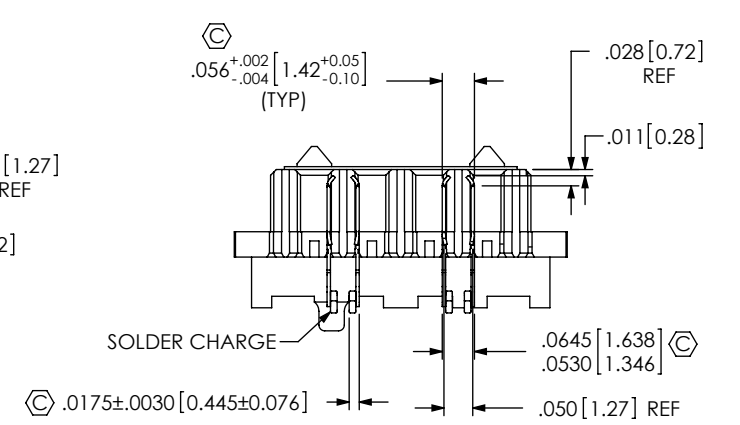
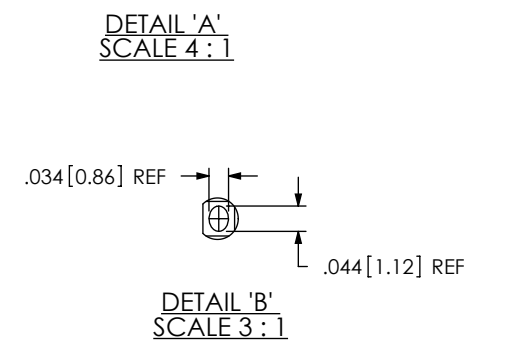
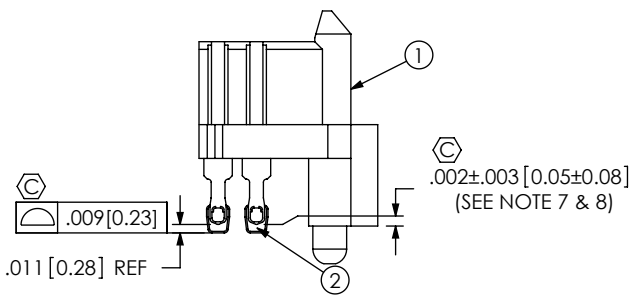
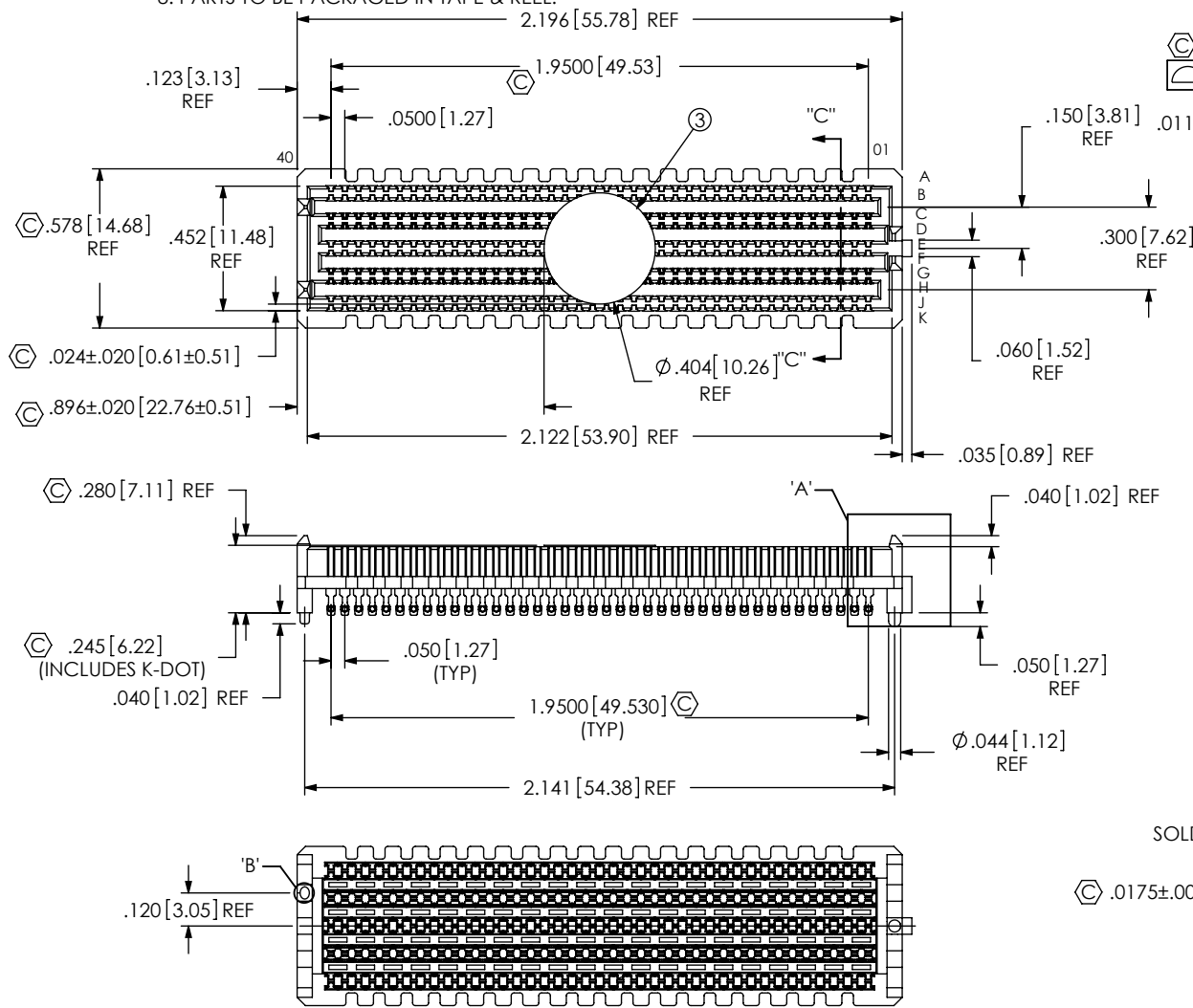

ITEM NO.	PART NUMBER	QUANTITY	MATERIAL
1	SEAM-40-03.5-10-A	1.0000	LCP UL 94 V0, COLOR: BLACK
2	SUB-T-1M36-03.5-S-1	1.0000	COPPER ALLOY/LEADED SOLDER $\text{\textcircled{C}}$
3	K-DOT-.404-.500-.005	160.00	POLYIMIDE FILM
4	CT-SEAM033MS	1.0000	CONDUCTIVE POLYMER

UNLESS OTHERWISE SPECIFIED, DIMENSIONS ARE IN INCHES.

TOLERANCES ARE:
 DECIMALS ANGLES
 .XX: $\pm .01 [0.3]$ 2°
 .XXX: $\pm .005 [0.13]$
 .XXXX: $\pm .0020 [0.051]$

PROPRIETARY NOTE
 THIS DOCUMENT CONTAINS CONFIDENTIAL AND PROPRIETARY INFORMATION AND ALL DESIGN, MANUFACTURING, REPRODUCTION, USE, PATENT RIGHTS AND SALES RIGHTS ARE EXPRESSLY RESERVED BY SAMTEC, INC. THIS DOCUMENT SHALL NOT BE DISCLOSED, IN WHOLE OR PART, TO ANY UNAUTHORIZED PERSON OR ENTITY NOR REPRODUCED, TRANSFERRED OR INCORPORATED IN ANY OTHER PROJECT IN ANY MANNER WITHOUT THE EXPRESS WRITTEN CONSENT OF SAMTEC, INC.

DO NOT SCALE DRAWING SHEET SCALE: 1.5:1

PLATING:
 CONTACT AREA: .000030 GOLD OVER .000050 NICKEL
 REMAINDER: .000200 REF TIN OVER .000050 NICKEL

samtec
 520 PARK EAST BLVD, NEW ALBANY, IN 47150
 PHONE: 812-944-6733 FAX: 812-948-5047
 e-Mail: info@SAMTEC.com code 55322

DESCRIPTION:
 .050 PITCH TERMINAL ARRAY ASSEMBLY

DWG. NO. ASP-127797-01

BY: B RAY 08/25/2006 SHEET 1 OF 4

F:\DWG\MISC\MKTG\ASP-127797-01-MKT.SLDDRW

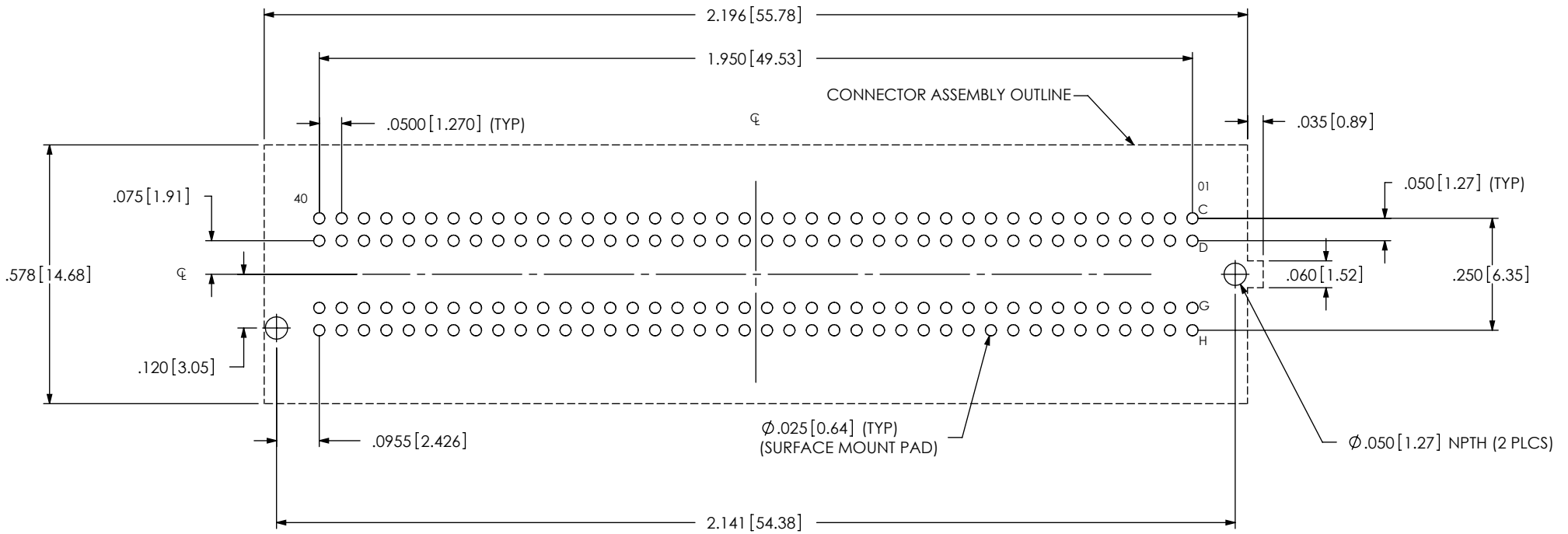

RECOMMENDED PCB LAYOUT
ALL DIMENSIONS ARE SYMMETRICAL ABOUT CENTERLINE

PROPRIETARY NOTE
THIS DOCUMENT CONTAINS CONFIDENTIAL AND PROPRIETARY INFORMATION AND ALL DESIGN, MANUFACTURING, REPRODUCTION, USE, PATENT RIGHTS AND SALES RIGHTS ARE EXPRESSLY RESERVED BY SAMTEC, INC. THIS DOCUMENT SHALL NOT BE DISCLOSED, IN WHOLE OR PART, TO ANY UNAUTHORIZED PERSON OR ENTITY NOR REPRODUCED, TRANSFERRED OR INCORPORATED IN ANY OTHER PROJECT IN ANY MANNER WITHOUT THE EXPRESS WRITTEN CONSENT OF SAMTEC, INC.



520 PARK EAST BLVD, NEW ALBANY, IN 47150
PHONE: 812-944-6733 FAX: 812-948-5047
e-Mail: info@SAMTEC.com code 55322

SHEET SCALE: 1.5:1

DESCRIPTION:
.050 PITCH TERMINAL ARRAY ASSEMBLY

DWG. NO.
ASP-127797-01

NOTE:
STENCIL TO BE .0060[0.152] THICK

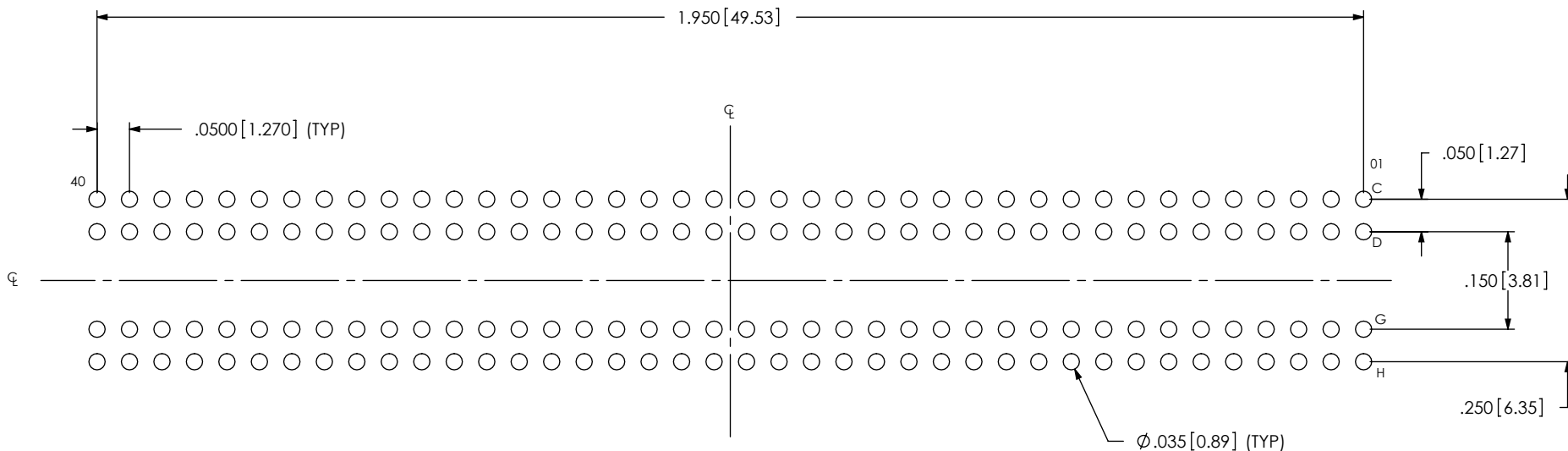

RECOMMENDED STENCIL LAYOUT
ALL DIMENSIONS ARE SYMMETRICAL ABOUT CENTERLINE

PROPRIETARY NOTE
THIS DOCUMENT CONTAINS CONFIDENTIAL AND PROPRIETARY INFORMATION AND ALL DESIGN, MANUFACTURING, REPRODUCTION, USE, PATENT RIGHTS AND SALES RIGHTS ARE EXPRESSLY RESERVED BY SAMTEC, INC. THIS DOCUMENT SHALL NOT BE DISCLOSED, IN WHOLE OR PART, TO ANY UNAUTHORIZED PERSON OR ENTITY NOR REPRODUCED, TRANSFERRED OR INCORPORATED IN ANY OTHER PROJECT IN ANY MANNER WITHOUT THE EXPRESS WRITTEN CONSENT OF SAMTEC, INC.



520 PARK EAST BLVD, NEW ALBANY, IN 47150
PHONE: 812-944-6733 FAX: 812-948-5047
e-Mail info@SAMTEC.com code 55322

SHEET SCALE: 1.5:1

DESCRIPTION:
.050 PITCH TERMINAL ARRAY ASSEMBLY

DWG. NO.
ASP-127797-01

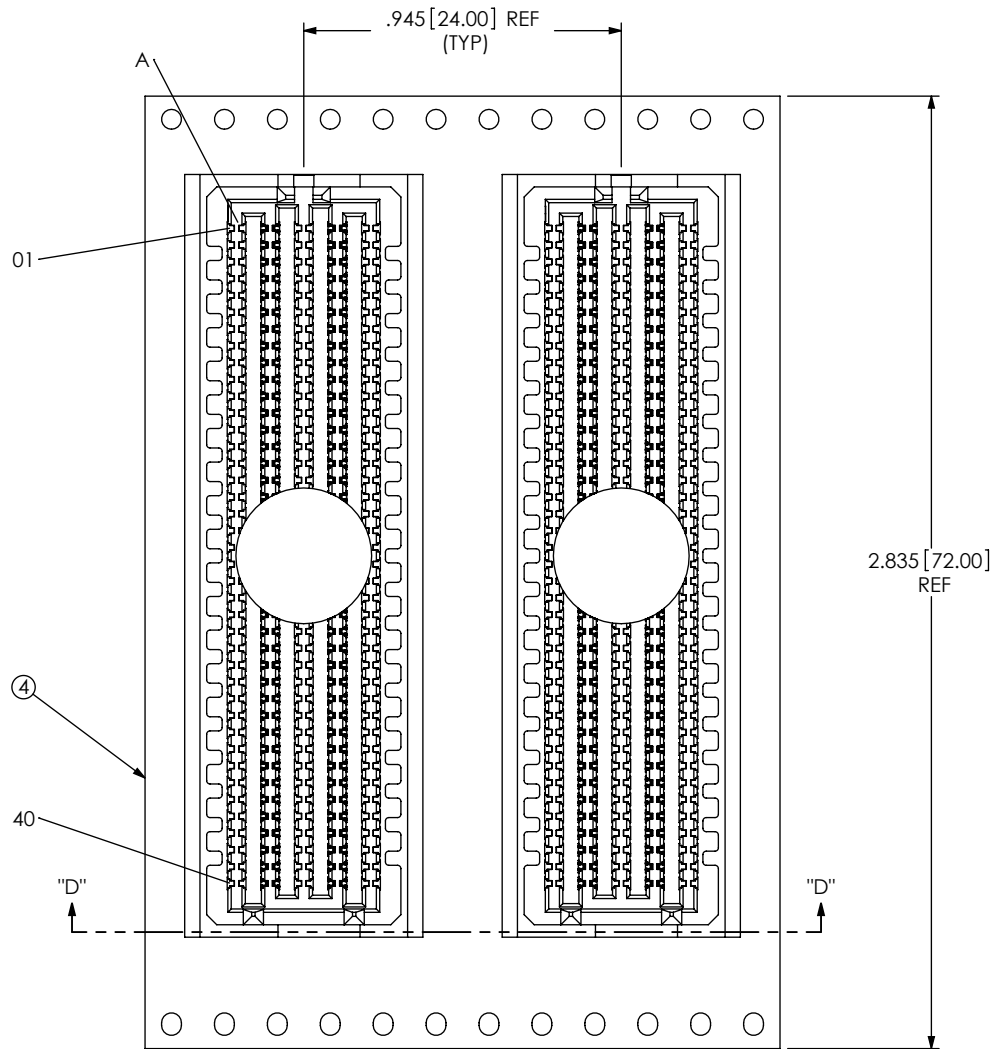

USER DIRECTION OF UN-REELING →
POCKET NOT DETAILED

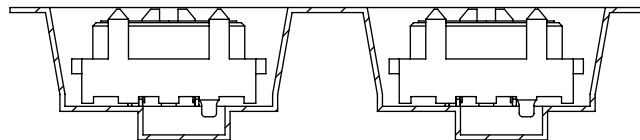

SECTION "D"-"D"
SCALE 1.75 : 1

PACKAGING VIEW

PROPRIETARY NOTE

THIS DOCUMENT CONTAINS CONFIDENTIAL AND PROPRIETARY INFORMATION AND ALL DESIGN, MANUFACTURING, REPRODUCTION, USE, PATENT RIGHTS AND SALES RIGHTS ARE EXPRESSLY RESERVED BY SAMTEC, INC. THIS DOCUMENT SHALL NOT BE DISCLOSED, IN WHOLE OR PART, TO ANY UNAUTHORIZED PERSON OR ENTITY NOR REPRODUCED, TRANSFERRED OR INCORPORATED IN ANY OTHER PROJECT IN ANY MANNER WITHOUT THE EXPRESS WRITTEN CONSENT OF SAMTEC, INC.



520 PARK EAST BLVD, NEW ALBANY, IN 47150
PHONE: 812-944-6733 FAX: 812-948-5047
e-Mail info@SAMTEC.com code 55322

SHEET SCALE: 1.75:1

DESCRIPTION:
.050 PITCH TERMINAL ARRAY ASSEMBLY

DWG. NO. ASP-127797-01

BY: B RAY 08/25/2006 SHEET 4 OF 4

Mouser Electronics

Authorized Distributor

Click to View Pricing, Inventory, Delivery & Lifecycle Information:

[Samtec:](#)

[ASP-127797-01](#)