

## Datasheet

Compact Indicator with One, Two, or Three Colors and a Momentary Push Button Output

To view or download the latest technical information about this product, including specifications, dimensions, accessories, and wiring, see [www.bannerengineering.com](http://www.bannerengineering.com).

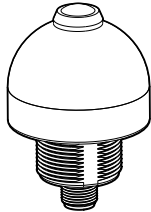

- Rugged, cost-effective and easy-to-install multicolor indicator light with pushbutton
- Waterproof IEC IP65 construction for washdown environments
- Excellent for panel mounting or as a stand-alone device
- Immune to EMI and RFI interference
- 12 V dc to 30 V dc operation
- Cabled and quick disconnect models available
- Up to 3 independent colors in one unit



### WARNING: Not To Be Used for Personnel Protection

Never use this device as a sensing device for personnel **protection**. Doing so could lead to serious injury or death. This device does not include the self-checking redundant circuitry necessary to allow its use in personnel safety applications. A sensor failure or malfunction can cause either an energized or de-energized sensor output condition.

## Models

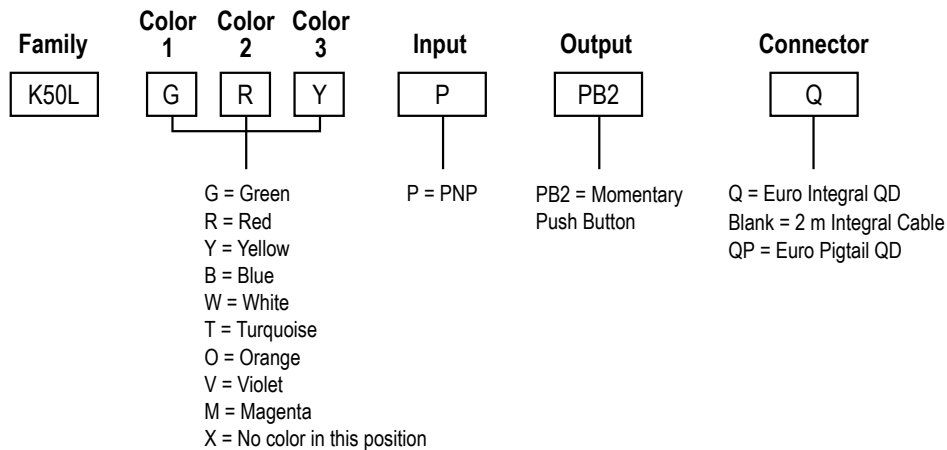

Example Model	# of LED Colors	LED Indicators	Connection <sup>1</sup>
K50LGXXPPB2Q	1	Green	4-pin M12/Euro-style integral QD Connector
K50LRXXPPB2Q		Red	
K50LGRXPPB2Q	2	Green, Red	5-pin M12/Euro-style QD Connector
K50LGYXPPB2Q		Green, Yellow	
K50LGRYPPB2Q	3	Green, Red, Yellow	8-pin M12/Euro-style QD Connector

<sup>1</sup> Integral quick disconnect models are listed.

- To order the 2 m (6.5 ft) PVC cable model, omit the suffix "Q" in the model number. For example, K50LGXXPPB2.
- To order the 150 mm (6 in) PVC cable model, replace the suffix "Q" with "QP" in the model number. For example, K50LGXXPPB2QP.
- Models with a quick disconnect require a mating cordset.



## Wiring Diagrams

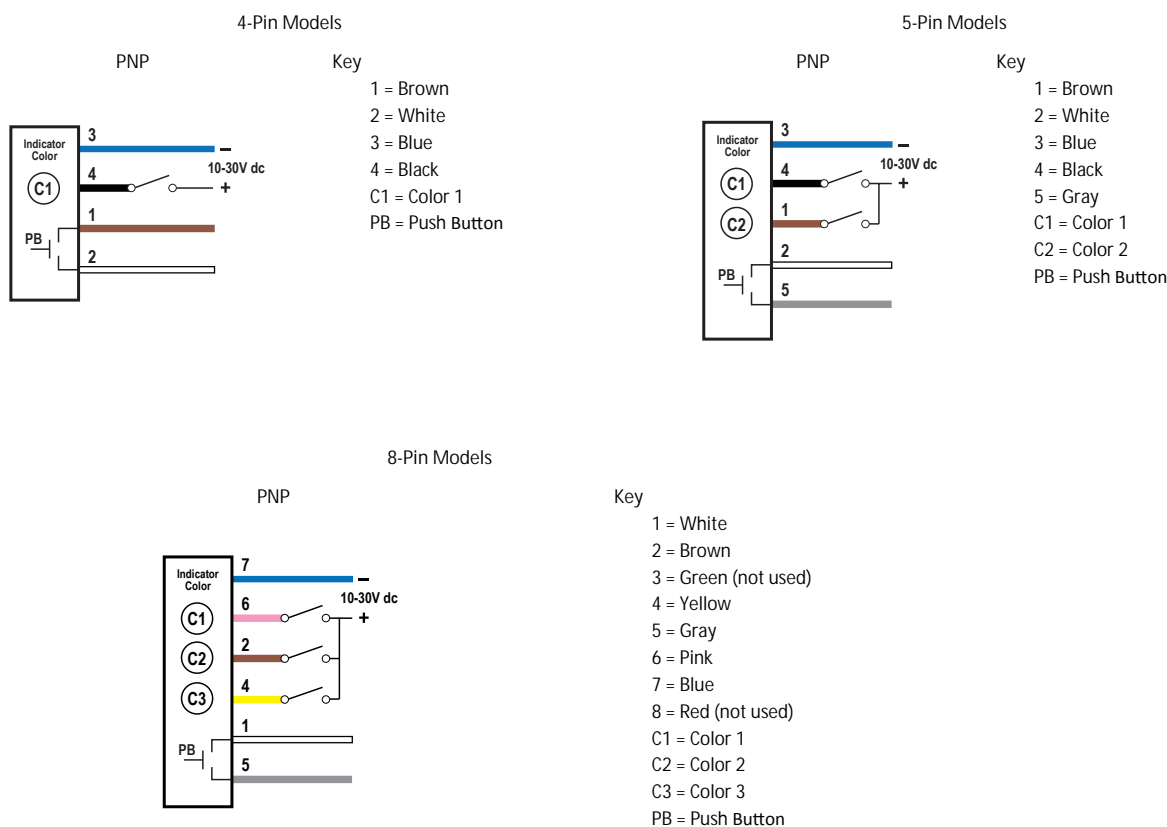

## Installation

Install the K50 sensor at such a height and in a location that will be easy for the user and/or supervisor to see the indicator and comfortable for the user to press the push-button.

## Specifications

### Supply Voltage and Current

12 V dc to 30 V dc  
65 mA at 12 V dc; 35 mA at 30 V dc maximum, current per LED color

### Supply Protection Circuitry

Protected against transient voltages and reverse polarity

### Switch Contact Rating

150 mA at 30 V dc

### Contact Bounce

10 ms maximum

### Environmental Rating

IEC IP65  
NEMA/UL Type 4X, 13

### Construction

Base: polycarbonate  
Translucent dome: polycarbonate  
Push button: thermoplastic

### Mounting Torque

2.25 Nm (20 in-ibf) maximum

### Connections

Integral M12/Euro-style quick disconnect, 2 m (6.5 ft) PVC jacketed cable or  
150 mm (6 in) PVC cable with quick disconnect, depending on model

### Operating Temperature

-40 °C to +50 °C (-40 °F to +122 °F)

### Max. Relative Humidity

90% at +50 °C maximum relative humidity (non-condensing)

### Storage Temperature

-40 °C to +70 °C (-40 °F to +158 °F)

### Certifications



## Dimensions

All measurements are listed in millimeters [inches], unless noted otherwise.

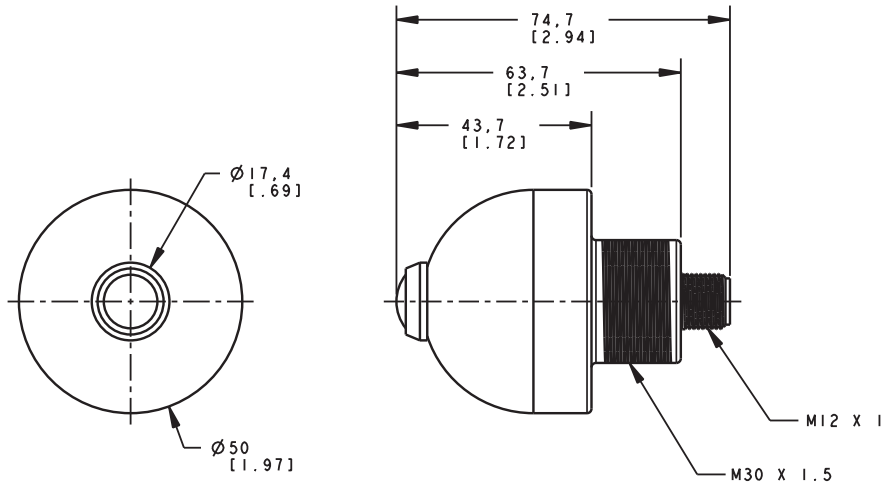

## Accessories

### Quick-Disconnect (QD) Cordsets

4-Pin Threaded M12/Euro-Style Cordsets				
Model	Length	Style	Dimensions	Pinout (Female)
MQDC-406	1.83 m (6 ft)	Straight		<p>1 = Brown 2 = White 3 = Blue 4 = Black</p>
MQDC-415	4.57 m (15 ft)			
MQDC-430	9.14 m (30 ft)			
MQDC-450	15.2 m (50 ft)			

5-Pin Threaded M12/Euro-Style Cordsets—Single Ended				
Model	Length	Style	Dimensions	Pinout (Female)
MQDC1-501.5	0.50 m (1.5 ft)	Straight		<p>1 = Brown 2 = White 3 = Blue 4 = Black 5 = Gray</p>
MQDC1-506	1.83 m (6 ft)			
MQDC1-515	4.57 m (15 ft)			
MQDC1-530	9.14 m (30 ft)			
MQDC1-506RA	1.83 m (6 ft)	Right-Angle		
MQDC1-515RA	4.57 m (15 ft)			
MQDC1-530RA	9.14 m (30 ft)			

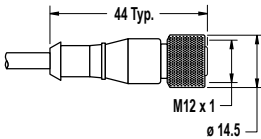
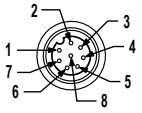
8-Pin Threaded M12/Euro-Style Cordsets with Shield				
Model	Length	Style	Dimensions	Pinout (Female)
MQDC-806	1.83 m (6 ft)	Straight		
MQDC-815	4.57 m (15 ft)			
MQDC-830	9.14 m (30 ft)			
				1 = White 2 = Brown 3 = Green 4 = Yellow 5 = Gray 6 = Pink 7 = Blue 8 = Shield

## Brackets

All measurements are in mm

### SMB30A

- Right-angle bracket with curved slot for versatile orientation
- Clearance for M6 (¼ in) hardware
- Mounting hole for 30 mm sensor
- 12-ga. stainless steel

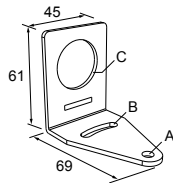

Hole center spacing: A to B=40

Hole size: A=ø 6.3, B= 27.1 x 6.3, C=ø 30.5

### SMB30FA

- Swivel bracket with tilt and pan movement for precise adjustment
- Mounting hole for 30 mm sensor
- 12-ga. 304 stainless steel
- Easy sensor mounting to extrude rail T-slot
- Metric and inch size bolt available

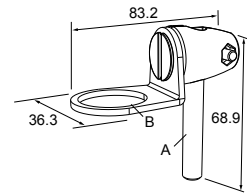

Bolt thread: SMB30FA, A= 3/8 - 16 x 2 in; SMB30FAM10, A= M10 - 1.5 x 50

Hole size: B= ø 30.1

### SMB30MM

- 12-ga. stainless steel bracket with curved mounting slots for versatile orientation
- Clearance for M6 (¼ in) hardware
- Mounting hole for 30 mm sensor

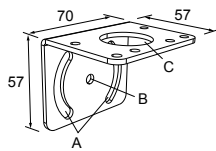

Hole center spacing: A = 51, A to B = 25.4

Hole size: A = 42.6 x 7, B = ø 6.4, C = ø 30.1

### SMB30SC

- Swivel bracket with 30 mm mounting hole for sensor
- Black reinforced thermoplastic polyester
- Stainless steel mounting and swivel locking hardware included

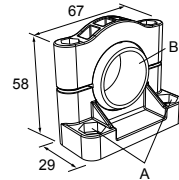

Hole center spacing: A=ø 50.8

Hole size: A=ø 7.0, B=ø 30.0

## Banner Engineering Corp. Limited Warranty

Banner Engineering Corp. warrants its products to be free from defects in material and workmanship for one year following the date of shipment. Banner Engineering Corp. will repair or replace, free of charge, any product of its manufacture which, at the time it is returned to the factory, is found to have been defective during the warranty period. This warranty does not cover damage or liability for misuse, abuse, or the improper application or installation of the Banner product.

THIS LIMITED WARRANTY IS EXCLUSIVE AND IN LIEU OF ALL OTHER WARRANTIES WHETHER EXPRESS OR IMPLIED (INCLUDING, WITHOUT LIMITATION, ANY WARRANTY OF MERCHANTABILITY OR FITNESS FOR A PARTICULAR PURPOSE), AND WHETHER ARISING UNDER COURSE OF PERFORMANCE, COURSE OF DEALING OR TRADE USAGE.

This Warranty is exclusive and limited to repair or, at the discretion of Banner Engineering Corp., replacement. IN NO EVENT SHALL BANNER ENGINEERING CORP. BE LIABLE TO BUYER OR ANY OTHER PERSON OR ENTITY FOR ANY EXTRA COSTS, EXPENSES, LOSSES, LOSS OF PROFITS, OR ANY INCIDENTAL, CONSEQUENTIAL OR SPECIAL DAMAGES RESULTING FROM ANY PRODUCT DEFECT OR FROM THE USE OR INABILITY TO USE THE PRODUCT, WHETHER ARISING IN CONTRACT OR WARRANTY, STATUTE, TORT, STRICT LIABILITY, NEGLIGENCE, OR OTHERWISE.

Banner Engineering Corp. reserves the right to change, modify or improve the design of the product without assuming any obligations or liabilities relating to any product previously manufactured by Banner Engineering Corp. Any misuse, abuse, or improper application or installation of this product or use of the product for personal protection applications when the product is identified as not intended for such purposes will void the product warranty. Any modifications to this product without prior express approval by Banner Engineering Corp will void the product warranties. All specifications published in this document are subject to change; Banner reserves the right to modify product specifications or update documentation at any time. Specifications and product information in English supersede that which is provided in any other language. For the most recent version of any documentation, refer to:

[www.bannerengineering.com](http://www.bannerengineering.com).



more sensors, more solutions

© Banner Engineering Corp. All rights reserved