

# LUXEON Rubix

High drive, tiny LED, max performance

LUXEON Rubix is a breakthrough design for the LED industry. Designed with high driving current capability and small form factor, it provides maximum flux in a minimal amount of space making it ideal for entertainment, architecture and emergency vehicle lighting application. This LED provides double the flux at much higher driving current compared to previous generations. It is the smallest form factor in the Lumileds Colors portfolio enabling it to be packaged even closer to achieve higher lumen output at higher lumen densities. The individual emitters and color gamut allow customers to have much better flexibility in their product design.

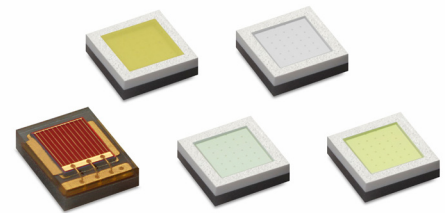

## FEATURES AND BENEFITS

Tiny footprint 1414 package

High Drive current up to 3 Amps DC

Maximized punch (cd/lm)

## PRIMARY APPLICATIONS

Moving Head

Spotlights

Wall Wash

Floodlights

Landscape Lighting

# Table of Contents

<b>General Product Information</b> .....	<b>2</b>
Product Test Conditions .....	2
Part Number Nomenclature .....	2
Lumen Maintenance .....	2
Environmental Compliance .....	2
<b>Performance Characteristics</b> .....	<b>3</b>
Product Selection Guide .....	3
Optical Characteristics .....	3
Electrical and Thermal Characteristics .....	4
<b>Absolute Maximum Ratings</b> .....	<b>4</b>
<b>Characteristic Curves</b> .....	<b>5</b>
Spectral Power Distribution Characteristics .....	5
Light Output Characteristics .....	6
Forward Current Characteristics .....	11
Radiation Pattern Characteristics .....	14
<b>Product Bin and Labeling Definitions</b> .....	<b>16</b>
Decoding Product Bin Labeling .....	16
Luminous Flux Bins .....	17
Radiometric Power Bins .....	17
Color Bin Definitions .....	18
Peak Wavelength Bins .....	19
Dominant Wavelength Bins .....	19
Forward Voltage Bins .....	19
<b>Mechanical Dimensions</b> .....	<b>20</b>
<b>Reflow Soldering Guidelines</b> .....	<b>22</b>
JEDEC Moisture Sensitivity .....	22
Solder Pad Design .....	23
<b>Packaging Information</b> .....	<b>23</b>
Pocket Tape Dimensions .....	23
Reel Dimensions .....	24

# General Product Information

## Product Test Conditions

LUXEON Rubix LEDs are tested and binned with a DC drive current of 1500mA at a junction temperature,  $T_j$ , of 85°C.

## Part Number Nomenclature

Part numbers for LUXEON Rubix Colors follow the convention below:

L 1 R X – **A A A** 1 0 0 0 0 0 0 0 0 0

Where:

**A A A** – designates color (RED=Red, GRN=Green, BLU=Blue, RYL=Royal Blue)

Therefore, the following part number is used for a LUXEON Rubix Red LED:

L 1 R X – **R E D** 1 0 0 0 0 0 0 0 0 0

Part numbers for LUXEON Rubix White follow the convention below:

L 1 R X – **A A B B** 0 0 0 0 0 0 0 0 0 0

Where:

**A A** – designates nominal CCT (57=5700K)

**B B** – designates minimum CRI (60=60CRI)

Therefore, the following part number is used for a LUXEON Rubix White 5700K 60CRI LED:

L 1 R X – **5 7 6 0** 0 0 0 0 0 0 0 0

## Lumen Maintenance

Please contact your local Sales Representative or Lumileds Technical Solutions Manager for more information about the long-term performance of this product.

## Environmental Compliance

Lumileds LLC is committed to providing environmentally friendly products to the solid-state lighting market. LUXEON Rubix is compliant to the European Union directives on the restriction of hazardous substances in electronic equipment, namely the RoHS Directive 2011/65/EU and REACH Regulation (EC) 1907/2006. Lumileds LLC will not intentionally add the following restricted materials to its products: lead, mercury, cadmium, hexavalent chromium, polybrominated biphenyls (PBB) or polybrominated diphenyl ethers (PBDE).

# Performance Characteristics

## Product Selection Guide

Table 1a. Product performance of LUXEON Rubix Colors at 1500mA, T<sub>j</sub>=85°C.

COLOR	DOMINANT OR PEAK WAVELENGTH <sup>[1]</sup> (nm)		LUMINOUS FLUX (lm) OR RADIOMETRIC POWER <sup>[2]</sup> (mW)		PART NUMBER
	MINIMUM	MAXIMUM	MINIMUM	TYPICAL	
Red	620	630	75	85	L1RX-RED1000000000
Green	520	535	260	310	L1RX-GRN1000000000
Blue	465	485	80	112	L1RX-BLU1000000000
Royal Blue	440	455	1300	1635	L1RX-RYL1000000000

**Notes for Table 1a:**

- Lumileds maintains a tolerance of ±6.5% on luminous flux measurements.
- Royal Blue is binned by peak wavelength. All other colors are binned by dominant wavelength.
- Royal Blue is binned by radiometric power. All other colors are binned by luminous flux.

Table 1b. Product performance of LUXEON Rubix White at 1500mA, T<sub>j</sub>=85°C.

COLOR	NOMINAL CCT	MINIMUM CRI <sup>[1]</sup>	LUMINOUS FLUX <sup>[1]</sup> (lm)		TYPICAL LUMINOUS EFFICACY (lm/W)	PART NUMBER
			MINIMUM	TYPICAL		
White	5700K	60	360	440	93	L1RX-5760000000000

**Notes for Table 1b:**

- Lumileds maintains a tolerance of ±6.5% on luminous flux and ±2 on CRI measurements for these products.

## Optical Characteristics

Table 2a. Optical characteristics for LUXEON Rubix Colors at 1500mA, T<sub>j</sub>=85°C.

COLOR	PART NUMBER	TYPICAL SPECTRAL HALF-WIDTH <sup>[1]</sup> (nm)	TYPICAL TEMPERATURE COEFFICIENT OF DOMINANT OR PEAK WAVELENGTH (nm/°C)	TYPICAL TOTAL INCLUDED ANGLE <sup>[2]</sup>	TYPICAL VIEWING ANGLE <sup>[3]</sup>
Red	L1RX-RED1000000000	22	0.15	140	125
Green	L1RX-GRN1000000000	36	0.04	140	125
Blue	L1RX-BLU1000000000	28	0.05	140	125
Royal Blue	L1RX-RYL1000000000	22	0.07	140	125

**Notes for Table 2a:**

- Spectral half-width is the spectral bandwidth at 50% of the peak intensity.
- Total angle at which 90% of total luminous flux is captured.
- Viewing angle is the off axis angle from the LED centerline where the luminous intensity is ½ of the peak value.

Table 2b. Optical characteristics for LUXEON Rubix White at 1500mA, T<sub>j</sub>=85°C.

COLOR	PART NUMBER	TYPICAL TOTAL INCLUDED ANGLE <sup>[1]</sup>	TYPICAL VIEWING ANGLE <sup>[2]</sup>
White	L1RX-5760000000000	140	125

**Notes for Table 2b:**

- Total angle at which 90% of total luminous flux is captured.
- Viewing angle is the off axis angle from the LED centerline where the luminous intensity is ½ of the peak value.

## Electrical and Thermal Characteristics

Table 3. Electrical and thermal characteristics for LUXEON Rubix at 1500mA, T<sub>j</sub>=85°C.

COLOR	PART NUMBER	FORWARD VOLTAGE <sup>[1]</sup> (V <sub>f</sub> )			TYPICAL TEMPERATURE COEFFICIENT OF FORWARD VOLTAGE <sup>[2]</sup> (mV/°C)	TYPICAL THERMAL RESISTANCE—JUNCTION TO SOLDER PAD (°C/W)
		MINIMUM	TYPICAL	MAXIMUM		
Red	L1RX-RED1000000000	2.00	2.30	2.80	-2.0	3.7
Green	L1RX-GRN1000000000	3.00	3.80	4.50	-3.8	5.4
Blue	L1RX-BLU1000000000	3.00	3.67	4.00	-3.9	4.5
Royal Blue	L1RX-RYL1000000000	2.50	3.16	3.50	-2.3	4.1
White	L1RX-5760000000000	2.50	3.16	3.50	-2.3	4.1

**Notes for Table 3:**

1. Lumileds maintains a tolerance of ±0.06V on forward voltage measurements.
2. Measured between 25°C and 85°C.

## Absolute Maximum Ratings

Table 4. Absolute maximum ratings for LUXEON Rubix.

PARAMETER	RED	GREEN AND BLUE	ROYAL BLUE	WHITE
DC Forward Current <sup>[1, 2]</sup>	2400mA	2200mA	3000mA	3000mA
Peak Pulsed Forward Current <sup>[1, 3]</sup>	2500mA	2500mA	3500mA	3500mA
LED Junction Temperature <sup>[1]</sup> (DC & Pulse)	135°C	150°C	150°C	135°C
ESD Sensitivity (ANSI/ESDA/JEDEC JS-001-2012)	Class 1A			
LED Storage Temperature	-40°C to 135°C			
Soldering Temperature	JEDEC 020c 260°C			
Allowable Reflow Cycles	3			
Reverse Voltage (V <sub>reverse</sub> )	LUXEON LEDs are not designed to be driven in reverse bias			

**Notes for Table 4:**

1. Proper current derating must be observed to maintain the junction temperature below the maximum allowable junction temperature.
2. Residual periodic variations due to power conversion from alternating current (AC) to direct current (DC), also called "ripple," are acceptable if the following conditions are met:
  - The frequency of the ripple current is 100Hz or higher
  - The average current for each cycle does not exceed the maximum allowable DC forward current
  - The maximum amplitude of the ripple does not exceed the maximum peak pulsed forward current
3. At 10% duty cycle with pulse width of 10ms.

# Characteristic Curves

## Spectral Power Distribution Characteristics

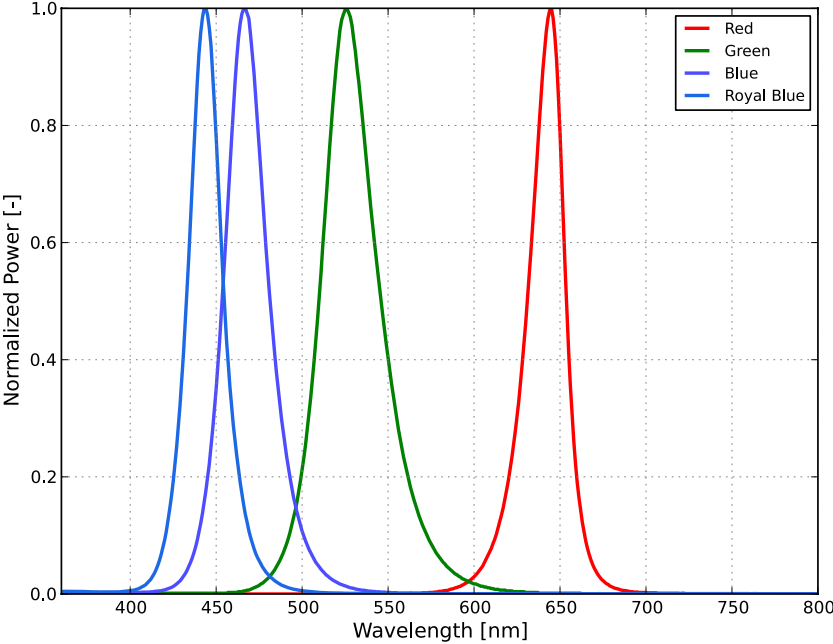

Figure 1a. Typical normalized power vs. wavelength for LUXEON Rubix Colors at 1500mA,  $T_j=85^\circ\text{C}$ .

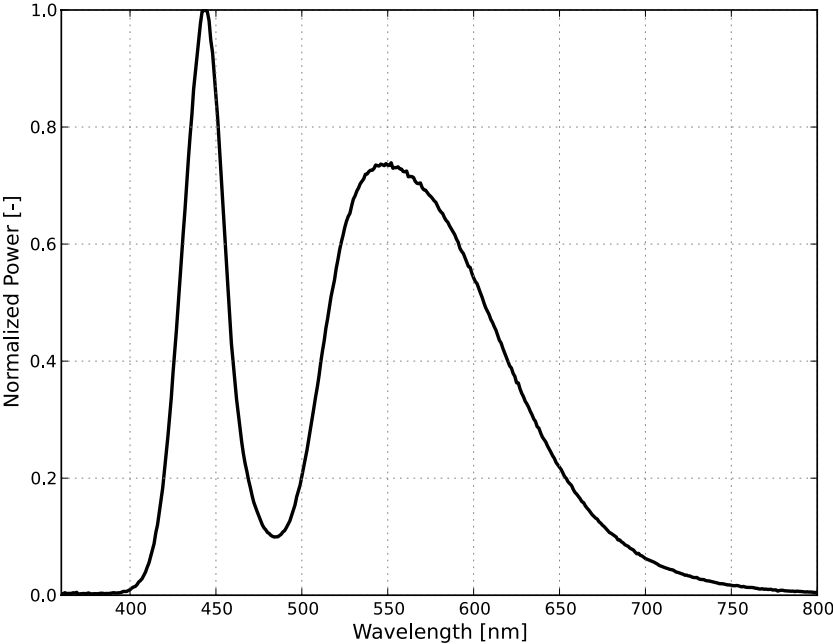

Figure 1b. Typical normalized power vs. wavelength for LUXEON Rubix White 5700K 60CRI at 1500mA,  $T_j=85^\circ\text{C}$ .

# Light Output Characteristics

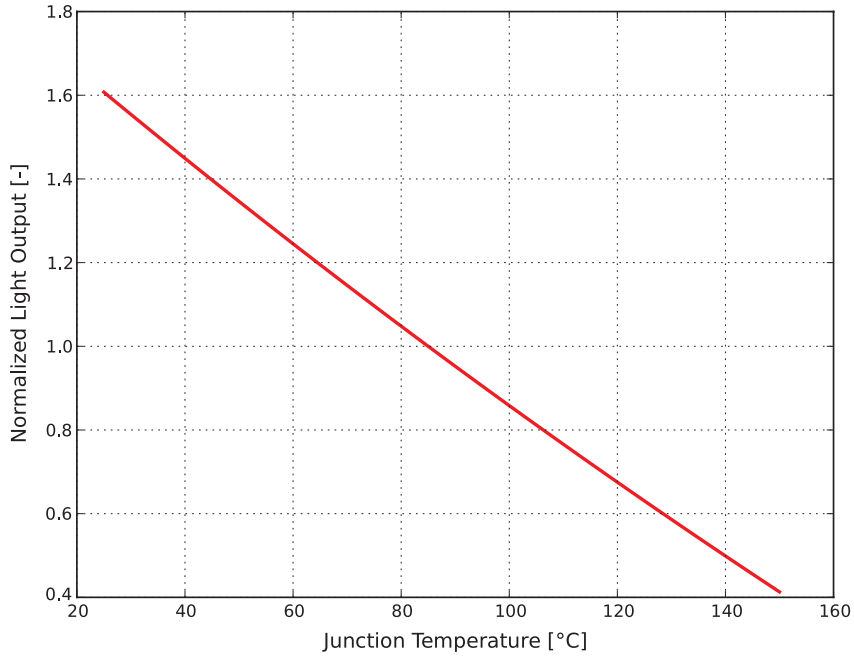

Figure 2a. Typical normalized radiant power vs. junction temperature for LUXEON Rubix Red 1500mA.

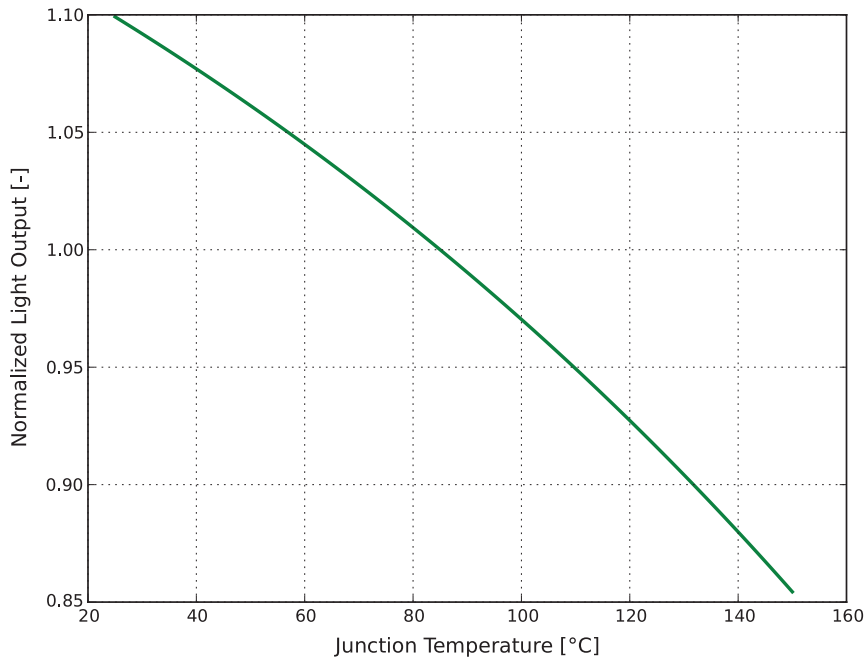

Figure 2b. Typical normalized light output vs. junction temperature for LUXEON Rubix Green at 1500mA.

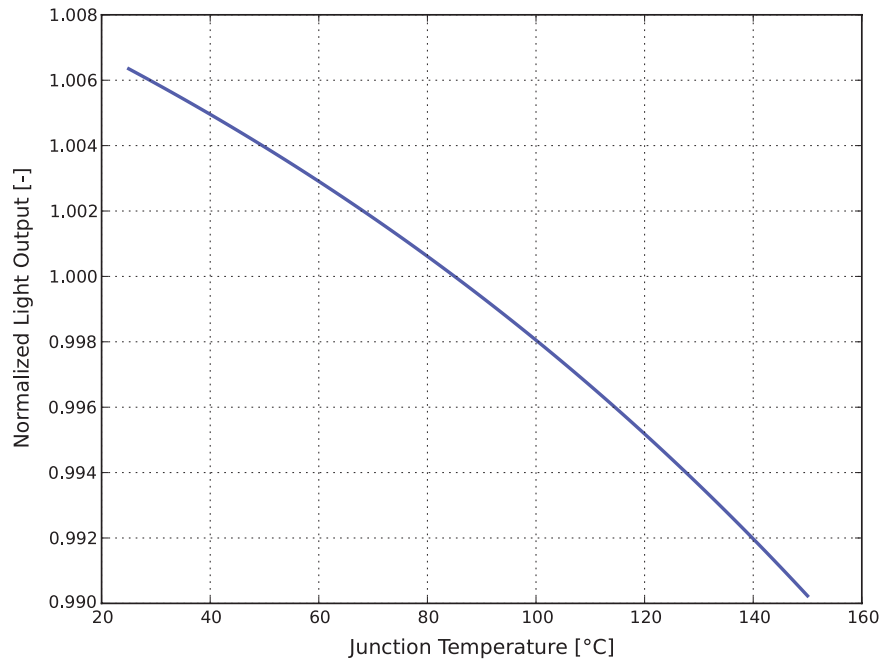

Figure 2c. Typical normalized light output vs. junction temperature for LUXEON Rubix Blue at 350mA.

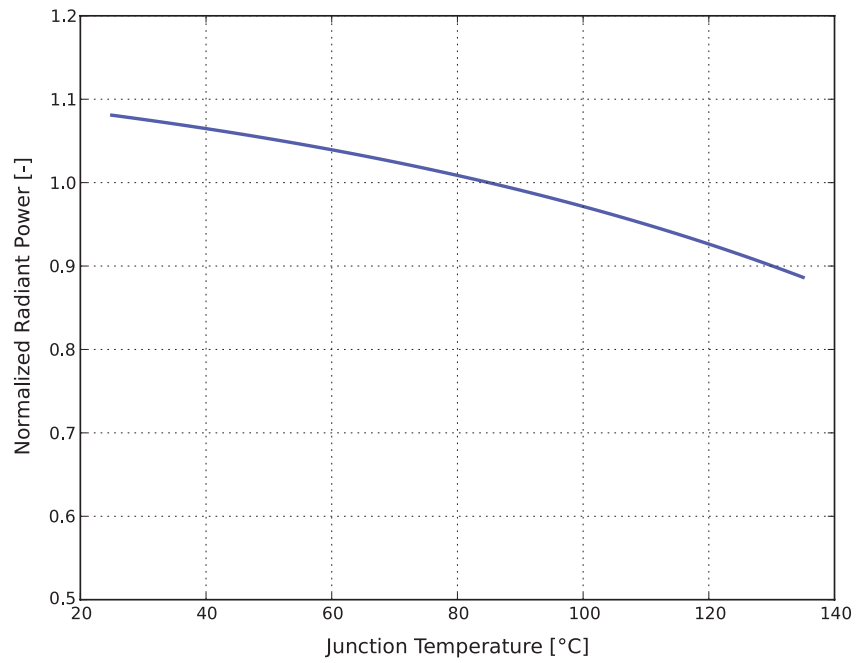

Figure 2d. Typical normalized radiant power vs. junction temperature for LUXEON Rubix Royal Blue at 1500mA.



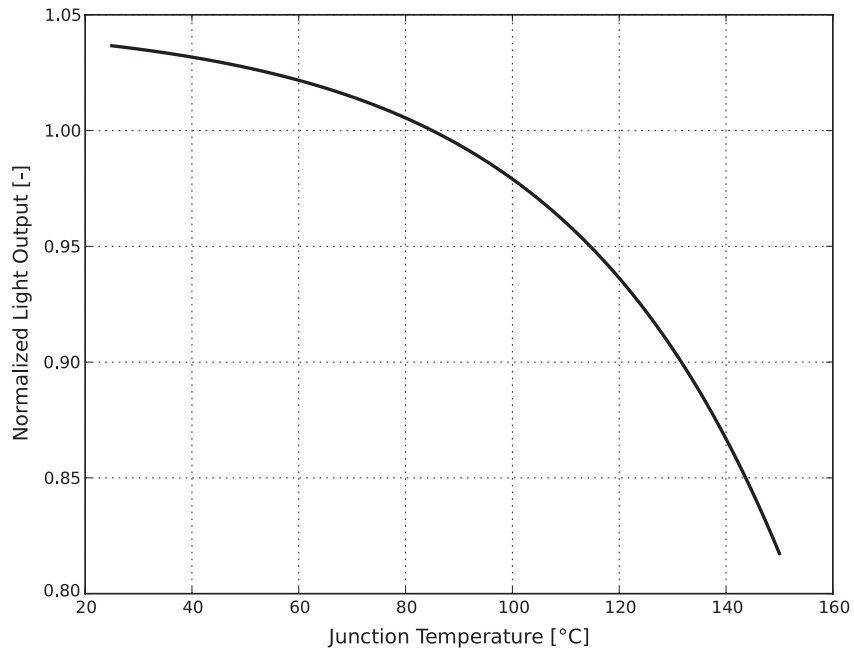

Figure 2e. Typical normalized light output vs. junction temperature for LUXEON Rubix White at 1500mA.

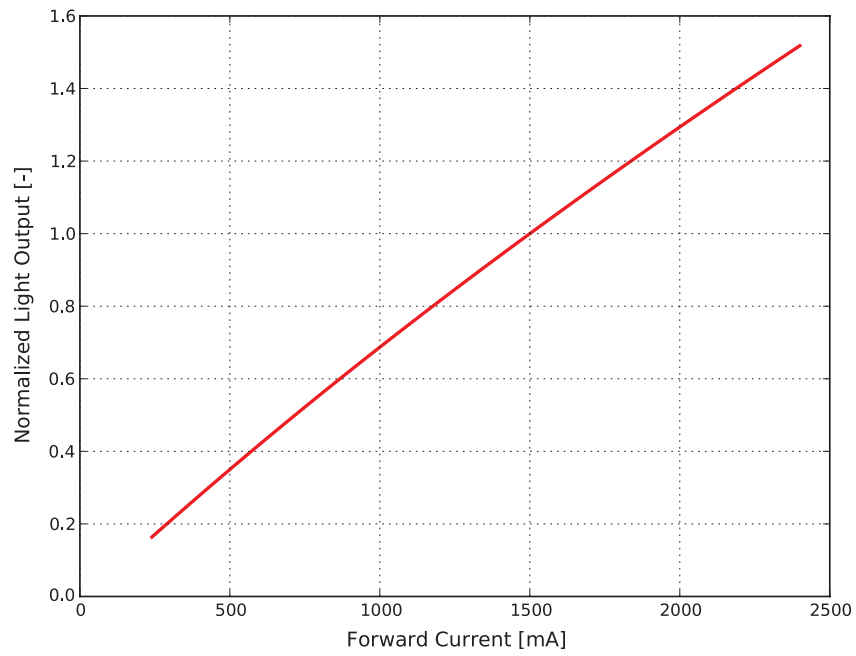

Figure 3a. Typical normalized radiant power vs. forward current for LUXEON Rubix Red at  $T_j=85^\circ\text{C}$ .

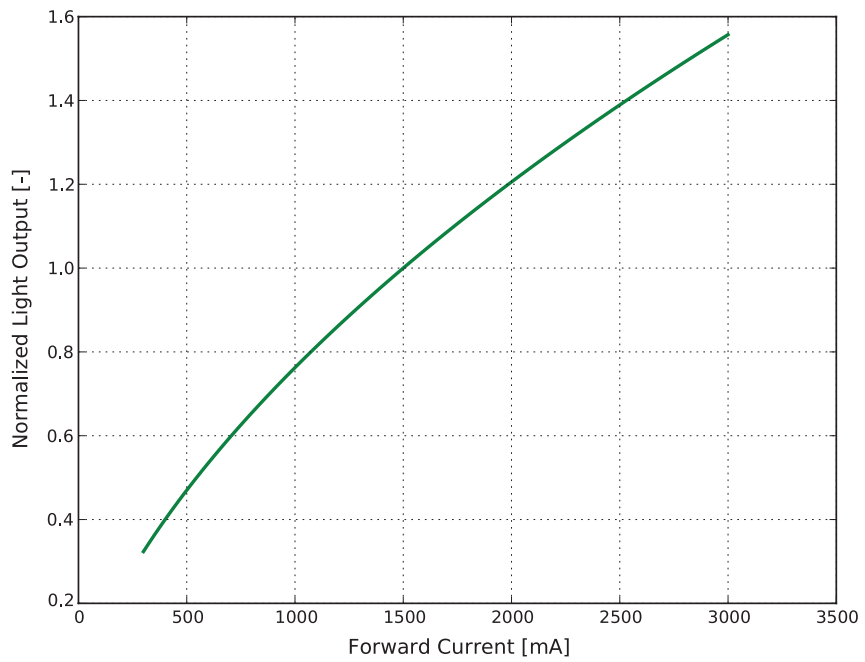

Figure 3b. Typical normalized light output vs. forward current for LUXEON Rubix Green at  $T_j=85^\circ\text{C}$ .

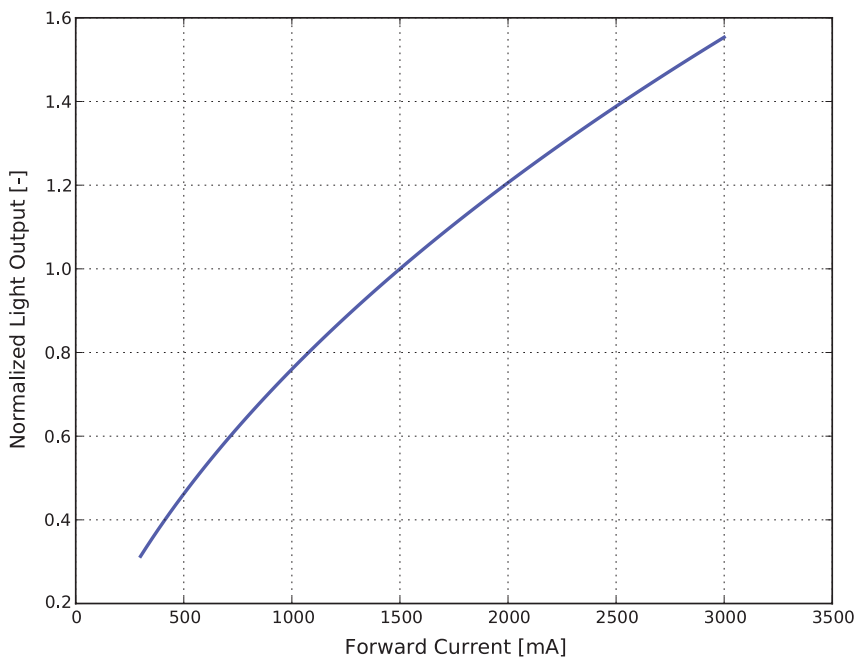

Figure 3c. Typical normalized light output vs. forward current for LUXEON Rubix Blue at  $T_j=85^\circ\text{C}$ .

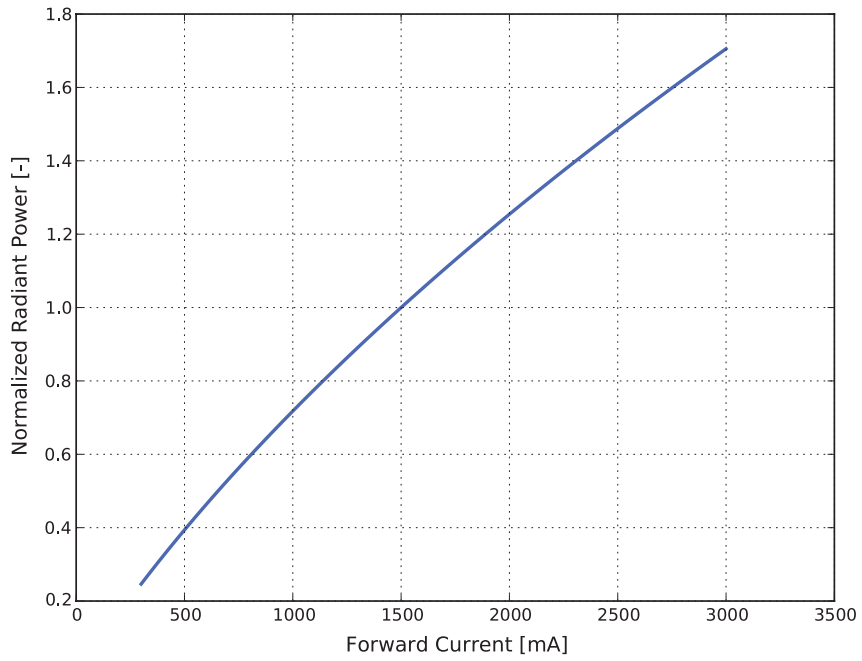

Figure 3d. Typical normalized radiant power vs. forward current for LUXEON Rubix Royal Blue at  $T_j=85^\circ\text{C}$ .

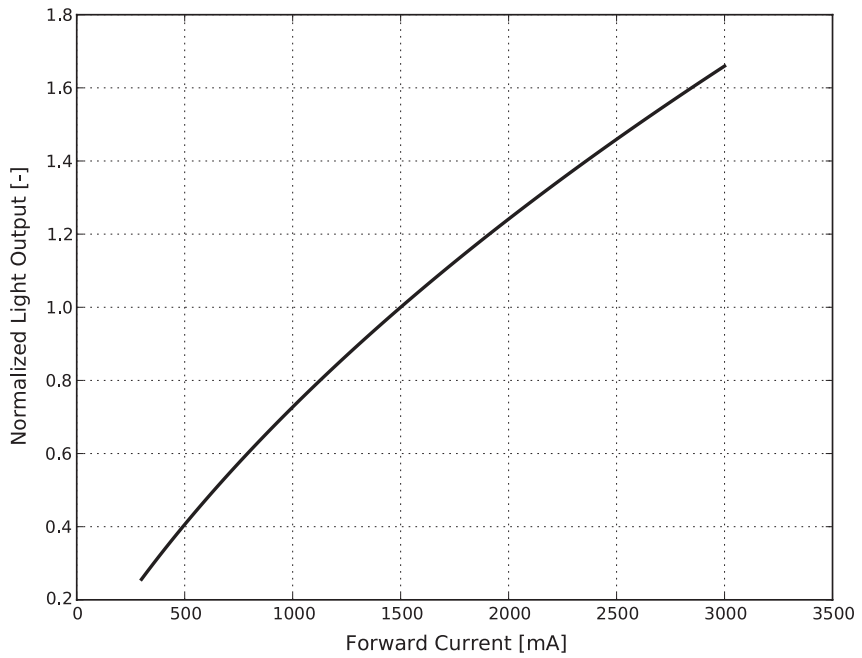

Figure 3e. Typical normalized light output vs. forward current for LUXEON Rubix White at  $T_j=85^\circ\text{C}$ .

# Forward Current Characteristics

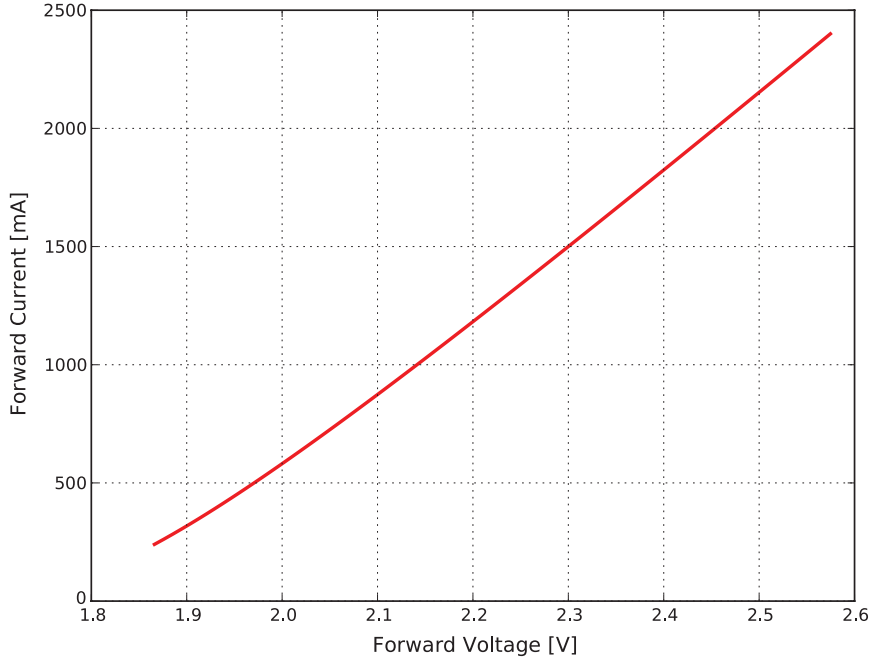

Figure 4a. Typical forward current vs. forward voltage for LUXEON Rubix Red at  $T_j=85^\circ\text{C}$ .

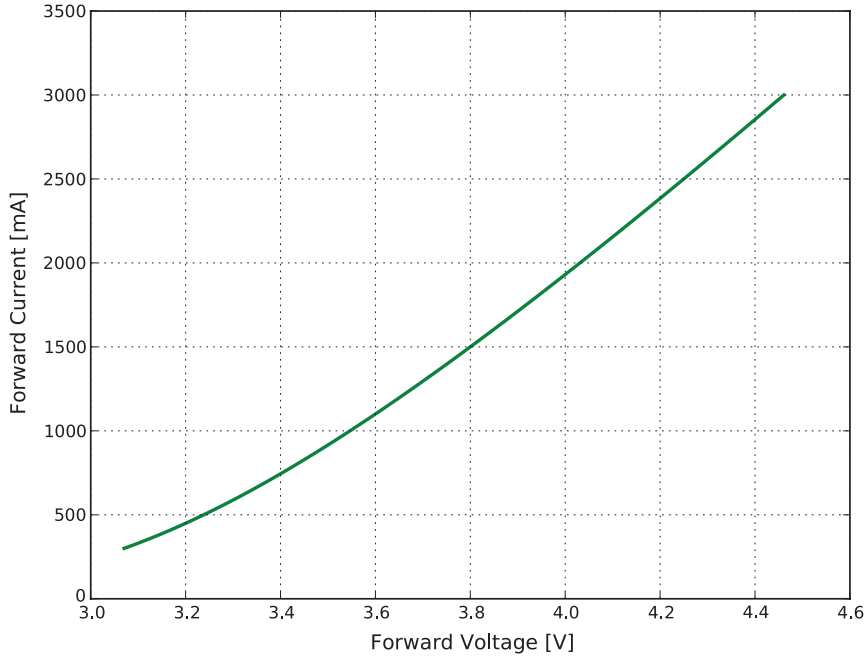

Figure 4b. Typical forward current vs. forward voltage for LUXEON Rubix Green at  $T_j=85^\circ\text{C}$ .

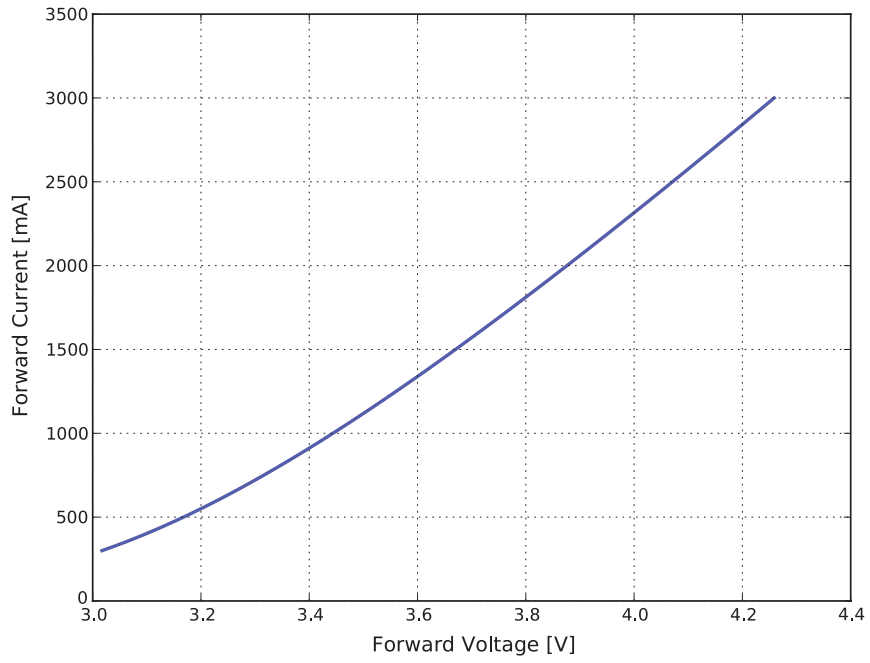

Figure 4c. Typical forward current vs. forward voltage for LUXEON Rubix Blue at  $T_j=85^\circ\text{C}$ .

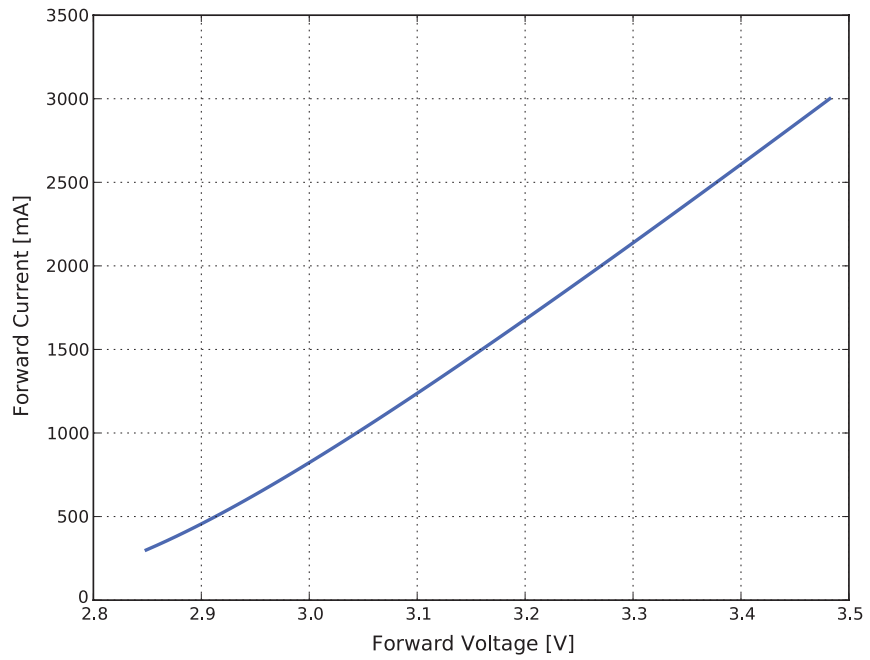

Figure 4d. Typical forward current vs. forward voltage for LUXEON Rubix Royal Blue at  $T_j=85^\circ\text{C}$ .

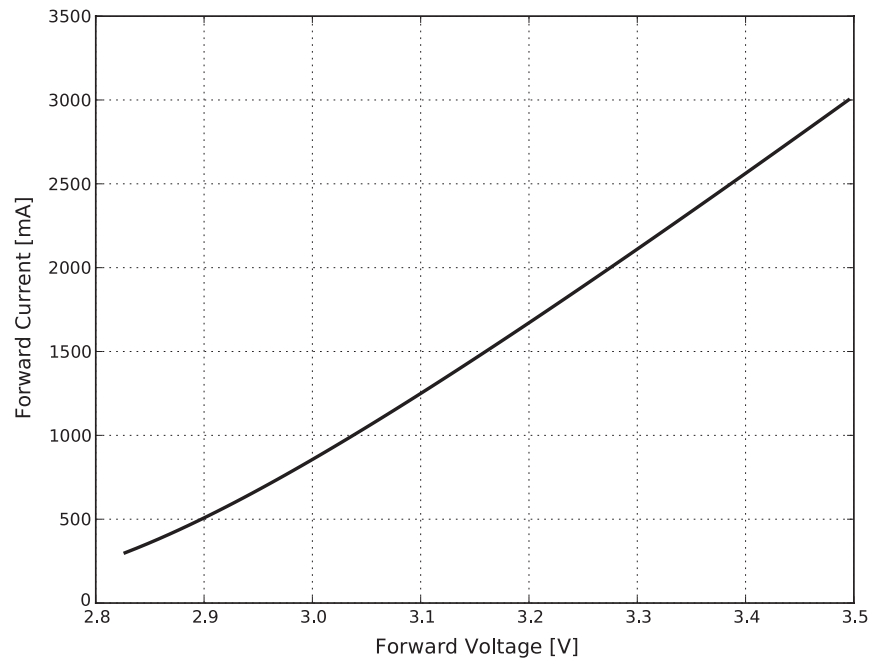

Figure 4e. Typical forward current vs. forward voltage for LUXEON Rubix White at  $T_j=85^\circ\text{C}$ .

# Radiation Pattern Characteristics

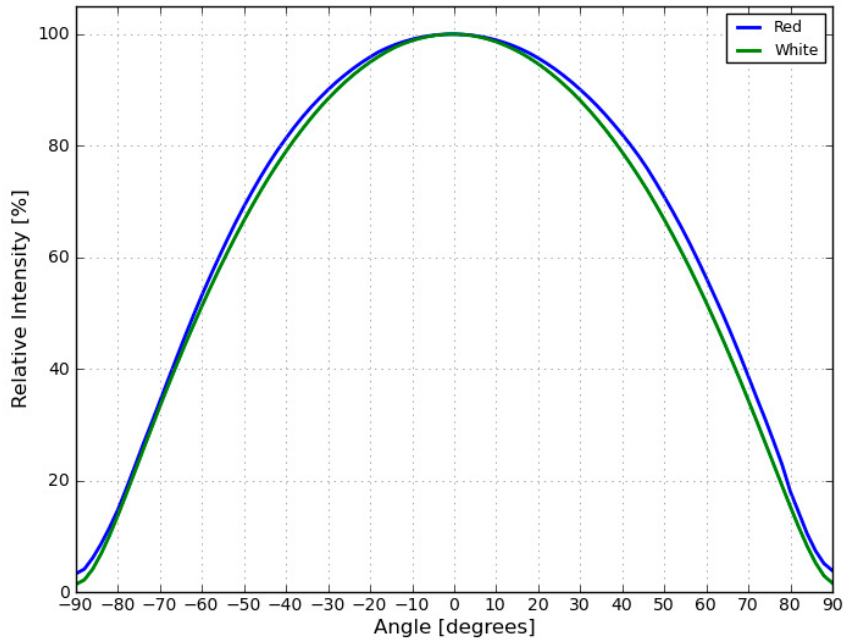

Figure 5a. Typical radiation pattern for LUXEON Rubix Red and White at 1500mA,  $T_j=85^\circ\text{C}$ .

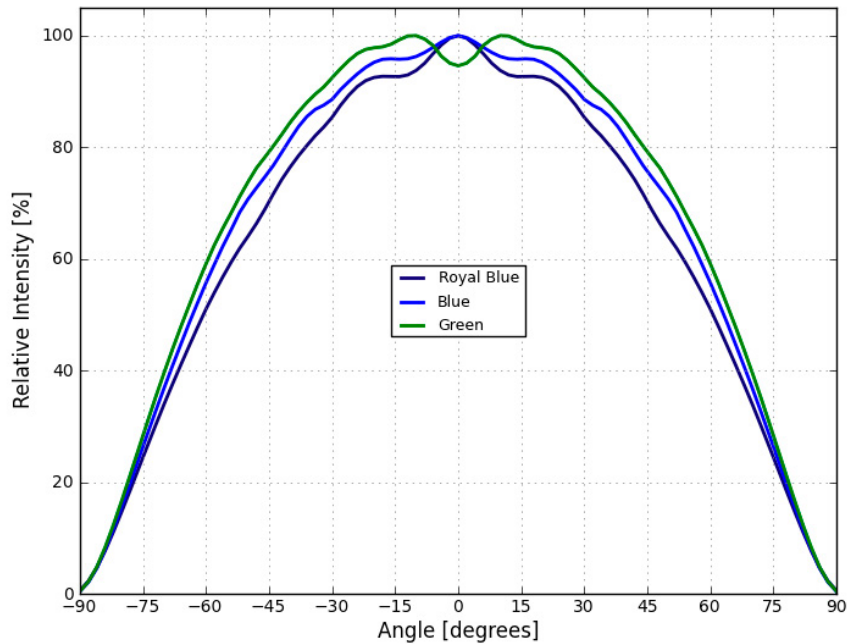

Figure 5b. Typical radiation pattern for LUXEON Rubix Green, Blue and Royal Blue at 1500mA,  $T_j=85^\circ\text{C}$ .

### Notes for Figures 5a and 5b:

1. The normalized intensity around  $0^\circ$  to  $\pm 30^\circ$  may fluctuate between the upper and lower bound limits.

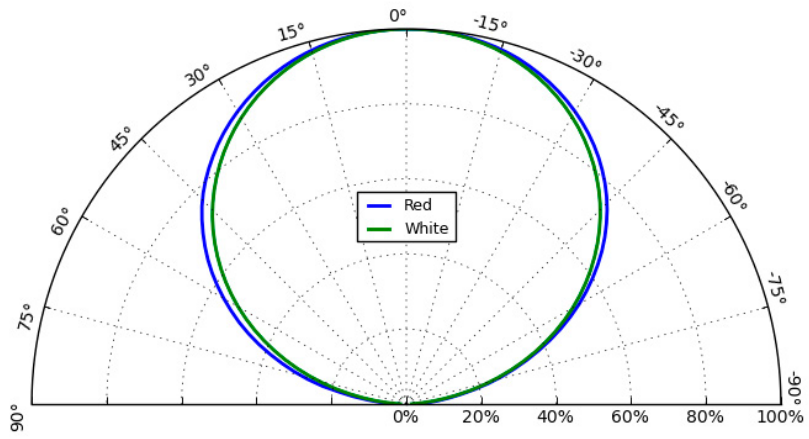

Figure 6a. Typical polar radiation pattern for LUXEON Rubix Red and White at 1500mA,  $T_j=85^\circ\text{C}$ .

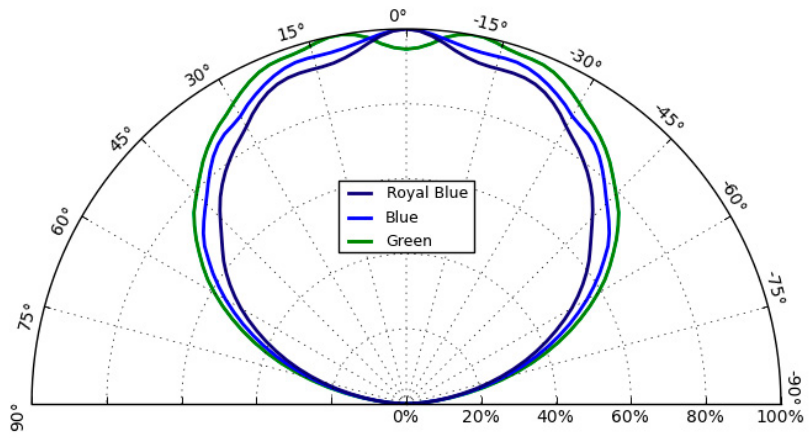

Figure 6b. Typical polar radiation pattern for LUXEON Rubix Green, Blue and Royal Blue at 1500mA,  $T_j=85^\circ\text{C}$ .

Notes for Figures 6a and 6b:

1. The normalized intensity around  $0^\circ$  to  $\pm 30^\circ$  may fluctuate between the upper and lower bound limits.



# Product Bin and Labeling Definitions

## Decoding Product Bin Labeling

In the manufacturing of semiconductor products, there are variations in performance around the average values given in the technical datasheet. For this reason, Lumileds bins LED components for luminous flux, radiometric power, color point, peak wavelength, dominant wavelength and forward voltage.

LUXEON Rubix LEDs are labeled using a 4-digit alphanumeric CAT code following the format below:

### **A B C D**

Where:

- A** – designates luminous flux bin or radiometric power bin (luminous flux bin example: A=60 to 70 lm, B= 70 to 80 lm; radiometric power bin example: Royal Blue C=1500 to 1600mW)
- B C** – designates color bin, peak wavelength bin or dominant wavelength bin (peak wavelength bin example: Royal Blue 30=440 to 445nm; dominant wavelength bin example: Red 40=620 to 630nm)
- D** – designates forward voltage bin (example: A=1.80 to 2.00V, B=2.00 to 2.20V)

Therefore, a LUXEON Rubix Red LED with a lumen range of 80 to 90 lm, a dominant wavelength of 620 to 630nm and a forward voltage range of 3.00 to 3.20V has the following CAT code:

### **C 4 0 G**

## Luminous Flux Bins

Table 5 lists the standard photometric luminous flux bins for LUXEON Rubix emitters. Although several bins are outlined, product availability in a particular bin varies by production run and by product performance. Not all bins are available in all CCTs.

Table 5. Luminous flux bin definitions for LUXEON Rubix.

BIN	LUMINOUS FLUX <sup>[1]</sup> (lm)	
	MINIMUM	MAXIMUM
A	60	70
B	70	80
C	80	90
D	90	100
E	100	110
F	110	120
G	120	140
H	140	160
J	160	180
K	180	200
L	200	220
M	220	240
N	240	260
P	260	280
Q	280	300
R	300	320
S	320	340
T	340	360
U	360	380
V	380	400
W	400	420
X	420	440
Y	440	460
Z	460	480

Notes for Table 5:

1. Lumileds maintains a tolerance of  $\pm 6.5\%$  on luminous flux measurements.

## Radiometric Power Bins

Table 6. Radiometric power bin definitions for LUXEON Rubix Royal Blue.

COLOR	BIN	RADIOMETRIC POWER <sup>[1]</sup> (mW)	
		MINIMUM	MAXIMUM
Royal Blue	B	1400	1500
	C	1500	1600
	D	1600	1700
	E	1700	1800
	F	1800	1900
	G	1900	2000

Notes for Table 6:

1. Lumileds maintains a tolerance of  $\pm 6.5\%$  on radiometric power measurements.

# Color Bin Definitions

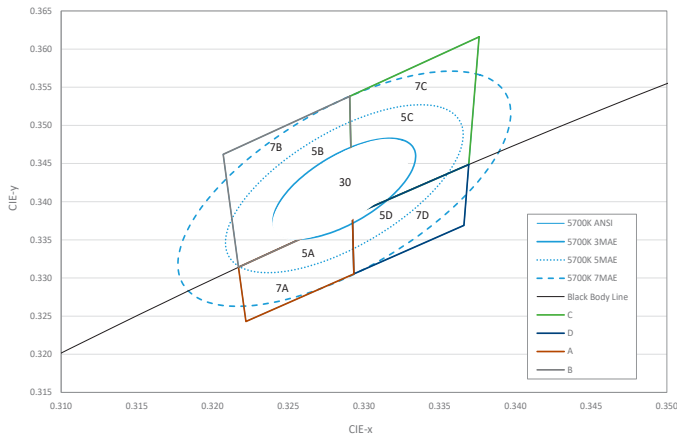

Figure 7. Color bin structure for LUXEON Rubix.

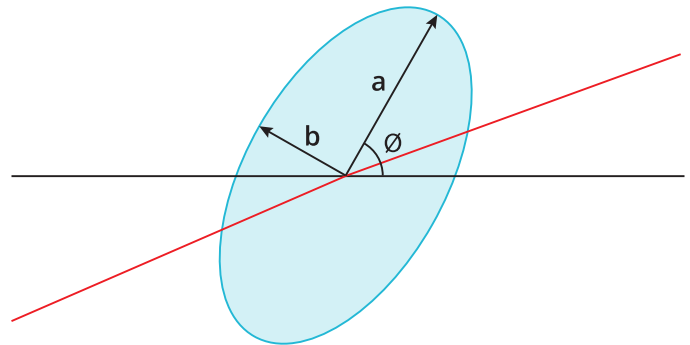

Figure 8. 3- and 5-step MacAdam ellipse illustration for Tables 7a and 7b.

Table 7a. 3- and 5-step MacAdam ellipse color bin definitions for LUXEON Rubix White at 1500mA,  $T_j = 85^\circ\text{C}$ .

NOMINAL CCT	COLOR SPACE	CENTER POINT <sup>[1]</sup> (cx, cy)	MAJOR AXIS, a	MINOR AXIS, b	ELLIPSE ROTATION ANGLE, $\theta$
5700K	Single 3-step MacAdam ellipse	(0.3287, 0.3417)	0.00746	0.00320	59.1°
5700K	Single 5-step MacAdam ellipse	(0.3287, 0.3417)	0.01243	0.00533	59.1°
5700K	Single 7-step MacAdam ellipse	(0.3287, 0.3417)	0.01740	0.00746	59.1°

**Notes for Table 7a:**

1. Lumileds maintains a tolerance of  $\pm 0.005$  on x and y coordinates in the CIE 1931 color space.

Table 7b. MacAdam ellipse color bin definitions for LUXEON Rubix White.

BIN	SDCM
30	Single 3-step MacAdam ellipse
5A	Single 5-step MacAdam ellipse
5B	Single 5-step MacAdam ellipse
5C	Single 5-step MacAdam ellipse
5D	Single 5-step MacAdam ellipse
7A	Single 7-step MacAdam ellipse
7B	Single 7-step MacAdam ellipse
7C	Single 7-step MacAdam ellipse
7D	Single 7-step MacAdam ellipse

## Peak Wavelength Bins

Table 8. Peak wavelength bin definitions for LUXEON Rubix Royal Blue.

COLOR	PART NUMBER	BIN	PEAK WAVELENGTH <sup>[1]</sup> (nm)	
			MINIMUM	MAXIMUM
Royal Blue	L1RX-RYL1000000000	30	440	445
		40	445	450
		50	450	455

**Notes for Table 8:**

1. Lumileds maintains a tolerance of  $\pm 2.0$ nm on peak wavelength measurements.

## Dominant Wavelength Bins

Table 9. Dominant wavelength bin definitions for LUXEON Rubix Red, Green, Blue at 1500mA,  $T_j=85^\circ\text{C}$ .

COLOR	PART NUMBER	BIN	DOMINANT WAVELENGTH <sup>[1]</sup> (nm)	
			MINIMUM	MAXIMUM
Red	L1RX-RED1000000000	40	620	630
Green	L1RX-GRN1000000000	10	520	525
		20	525	530
		30	530	535
Blue	L1RX-BLU1000000000	10	460	465
		20	465	470
		30	470	475
		40	475	480
		50	480	485

**Notes for Table 9:**

1. Lumileds maintains a tolerance of  $\pm 0.5$ nm on dominant wavelength measurements.

## Forward Voltage Bins

Table 10. Forward voltage bin definitions for LUXEON Rubix.

BIN	FORWARD VOLTAGE <sup>[1]</sup> (V <sub>f</sub> )	
	MINIMUM	MAXIMUM
A	1.80	2.00
B	2.00	2.20
C	2.20	2.40
D	2.40	2.60
E	2.60	2.80
F	2.80	3.00
G	3.00	3.20
H	3.20	3.40
J	3.40	3.60
K	3.60	3.80
L	3.80	4.00
M	4.00	4.20
N	4.20	4.40
P	4.40	4.50

**Notes for Table 10:**

1. Lumileds maintains a tolerance of  $\pm 0.06$ V on forward voltage measurements.

# Mechanical Dimensions

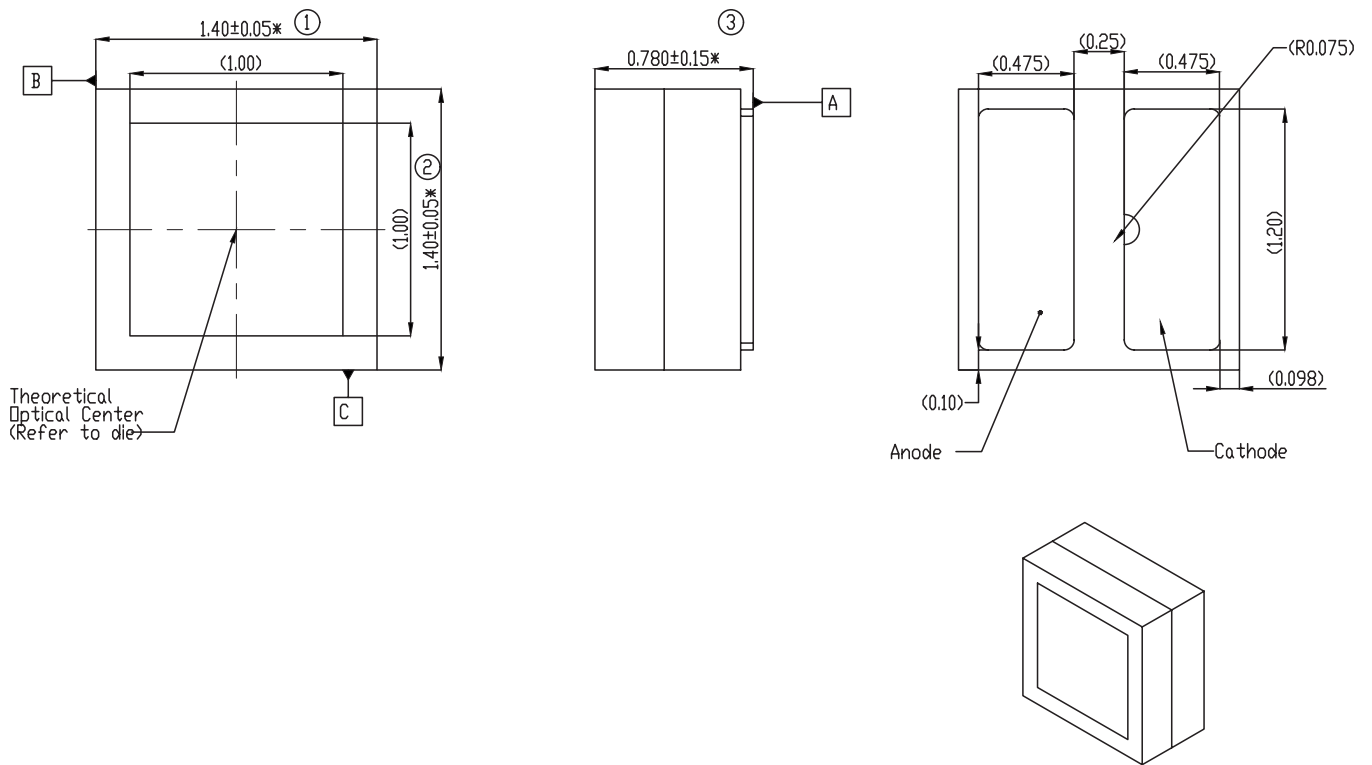

Figure 9a. Mechanical dimensions for LUXEON Rubix Green, Blue, Royal Blue and White Colors.

**Notes for Figure 9a:**

1. Drawings are not to scale.
2. All dimensions are in millimeters.

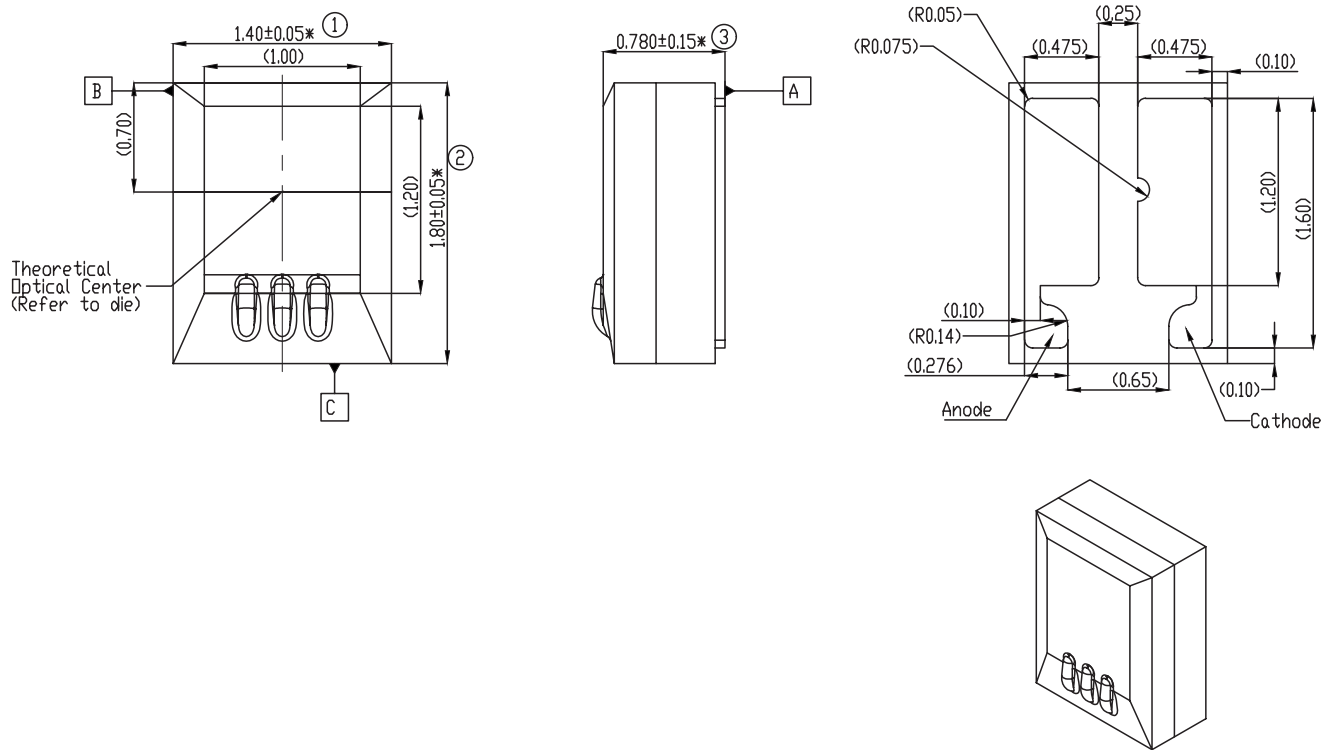

Figure 9b. Mechanical dimensions for LUXEON Rubix Red Color.

- Notes for Figure 9b:
1. Drawings are not to scale.
  2. All dimensions are in millimeters.

# Reflow Soldering Guidelines

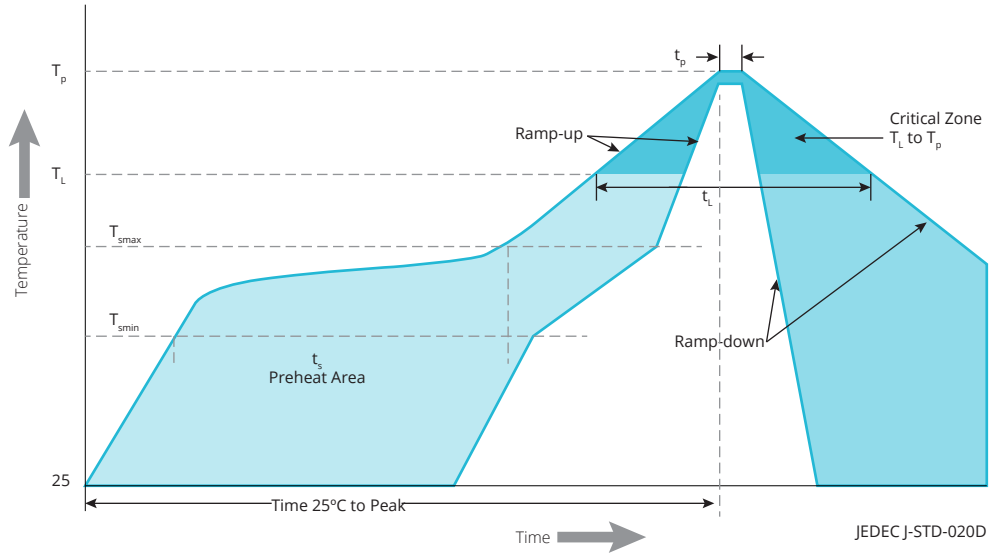

Figure 10. Visualization of the acceptable reflow temperature profile as specified in Table 12.

Table 11. Reflow profile characteristics for LUXEON Rubix.

PROFILE FEATURE	LEAD-FREE ASSEMBLY
Preheat Minimum Temperature ( $T_{smin}$ )	150°C
Preheat Maximum Temperature ( $T_{smax}$ )	200°C
Preheat Time ( $t_{smin}$ to $t_{smax}$ )	60 to 120 seconds
Ramp-Up Rate ( $T_L$ to $T_p$ )	3°C / second maximum
Liquidus Temperature ( $T_L$ )	217°C
Time Maintained Above Temperature $T_L$ ( $t_L$ )	60 to 150 seconds
Peak / Classification Temperature ( $T_p$ )	260°C
Time Within 5°C of Actual Temperature ( $t_p$ )	20 to 40 seconds
Ramp-Down Rate ( $T_p$ to $T_L$ )	6°C / second maximum
Time 25°C to Peak Temperature	8 minutes maximum

## JEDEC Moisture Sensitivity

Table 12. Moisture sensitivity levels for LUXEON Rubix.

LEVEL	FLOOR LIFE		SOAK REQUIREMENTS STANDARD	
	TIME	CONDITIONS	TIME	CONDITIONS
1	Unlimited	≤30°C / 85% RH	168 Hours +5 / -0	85°C / 85% RH

# Solder Pad Design

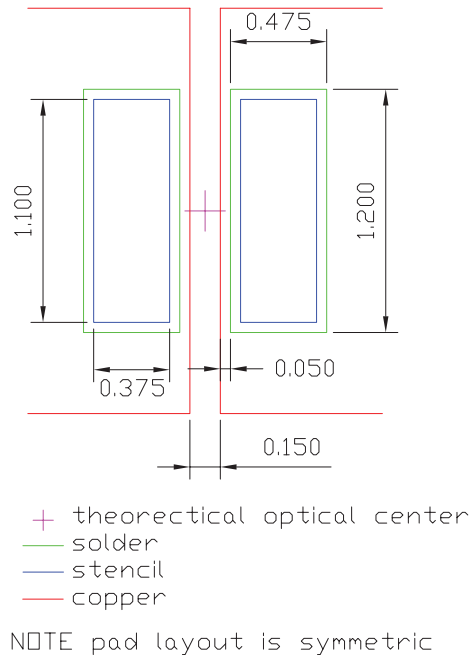

Figure 11. Recommended PCB solder pad layout for LUXEON Rubix.

- Notes for Figure 11:
1. Drawings are not to scale.
  2. All dimensions are in millimeters.

# Packaging Information

## Pocket Tape Dimensions

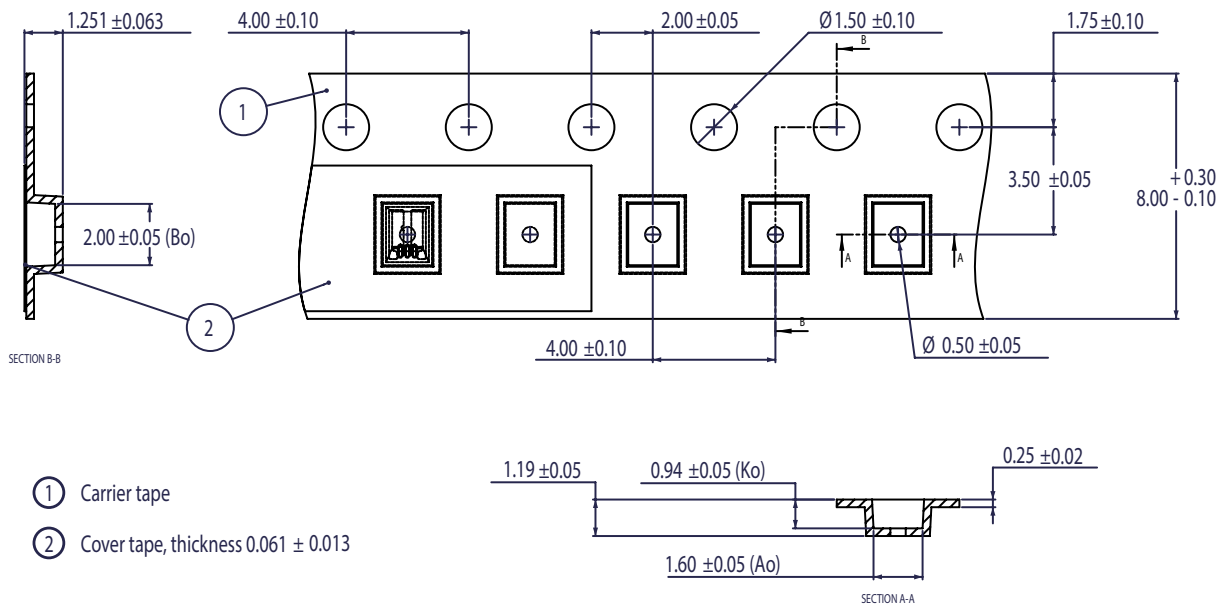

Figure 12a. Pocket Tape dimensions for LUXEON Rubix Red.

- Notes for Figure 12a:
1. Drawings are not to scale.
  2. All dimensions are in millimeters.



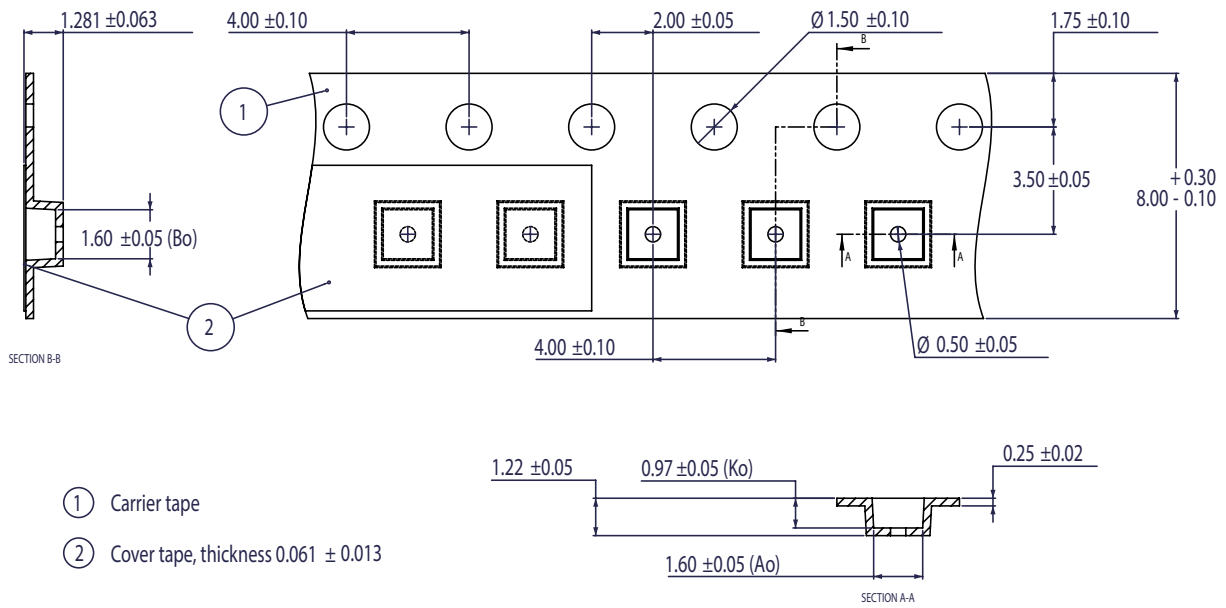

Figure 12b. Pocket Tape dimensions for LUXEON Rubix Green, Blue, Royal Blue and White.

Notes for Figure 12b:

1. Drawings are not to scale.
2. All dimensions are in millimeters.

## Reel Dimensions

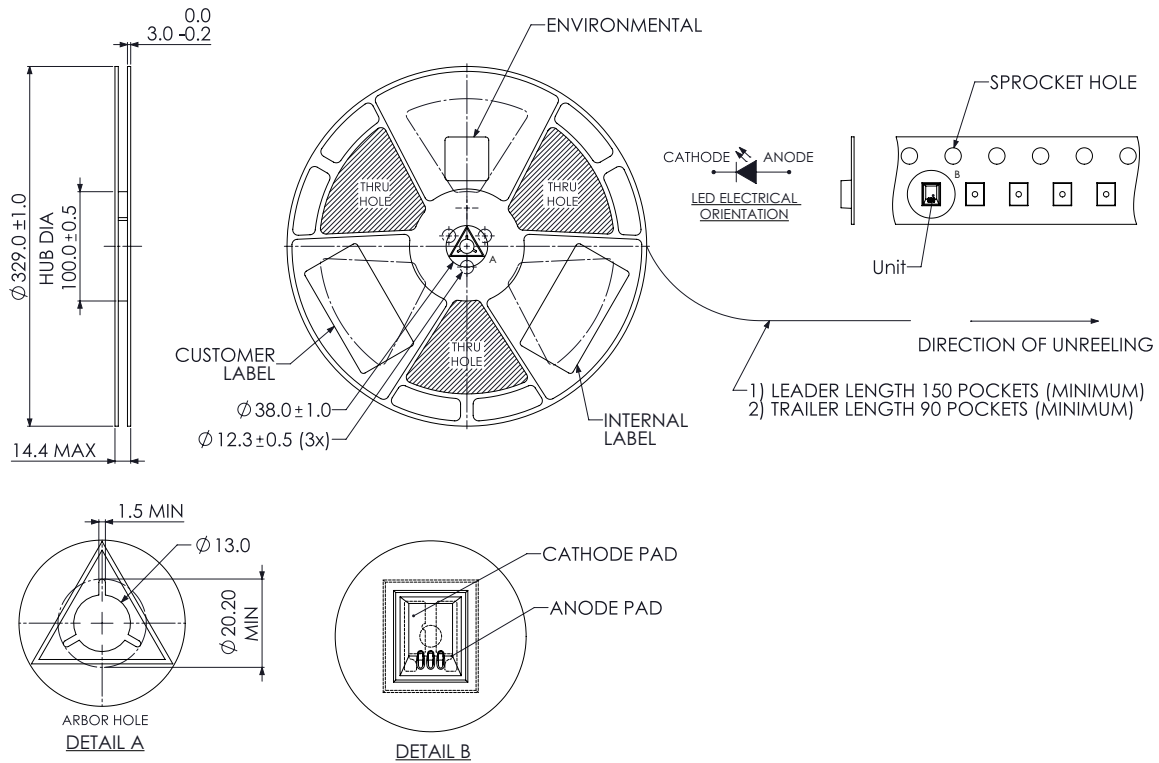

Figure 13a. Reel dimensions for LUXEON Rubix Red.

Notes for Figure 13a:

1. Drawings are not to scale.
2. All dimensions are in millimeters.
3. Maximum 1,000 pieces per reel.

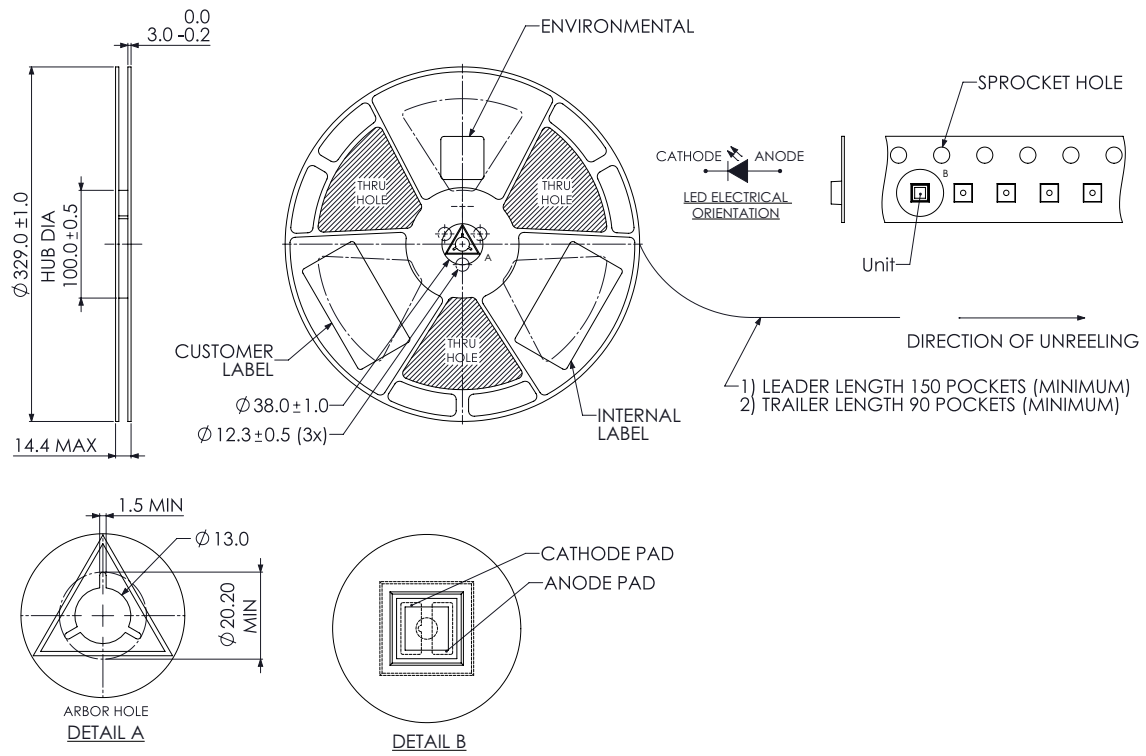

Figure 13b. Reel dimensions for LUXEON Rubix Green, Blue, Royal Blue and White.

Notes for Figure 13b:

1. Drawings are not to scale.
2. All dimensions are in millimeters.
3. Maximum 1,000 pieces per reel.

## About Lumileds

Companies developing automotive, mobile, IoT and illumination lighting applications need a partner who can collaborate with them to push the boundaries of light. With over 100 years of inventions and industry firsts, Lumileds is a global lighting solutions company that helps customers around the world deliver differentiated solutions to gain and maintain a competitive edge. As the inventor of Xenon technology, a pioneer in halogen lighting and the leader in high performance LEDs, Lumileds builds innovation, quality and reliability into its technology, products and every customer engagement. Together with its customers, Lumileds is making the world better, safer, more beautiful—with light.

To learn more about our lighting solutions, visit [lumileds.com](http://lumileds.com).



©2020 Lumileds Holding B.V. All rights reserved.  
LUXEON is a registered trademark of the Lumileds Holding B.V. in the United States and other countries.

[lumileds.com](http://lumileds.com)

Neither Lumileds Holding B.V. nor its affiliates shall be liable for any kind of loss of data or any other damages, direct, indirect or consequential, resulting from the use of the provided information and data. Although Lumileds Holding B.V. and/or its affiliates have attempted to provide the most accurate information and data, the materials and services information and data are provided "as is," and neither Lumileds Holding B.V. nor its affiliates warrants or guarantees the contents and correctness of the provided information and data. Lumileds Holding B.V. and its affiliates reserve the right to make changes without notice. You as user agree to this disclaimer and user agreement with the download or use of the provided materials, information and data. A listing of Lumileds product/patent coverage may be accessed at [lumileds.com/patents](http://lumileds.com/patents).