

Half-Bridge IPM for Low Voltage Applications

***μ*IPM™**

80A, 40V

Description

The IRSM005-800MH is a general purpose half-bridge with integrated gate driver in an attractive 7x8mm PQFN package. It is a general purpose building block suitable for a variety of low voltage applications where power density is of critical importance. Typical examples would be advanced motor drives, dc-to-ac and dc-to-dc converters.

Features

- Package with low thermal resistance and minimal parasitics
- Low on-resistance HEXFETs: 2.7 mΩ typ.
- Undervoltage lockout on logic supply
- Independent gate drive in phase with logic input
- Gate drive supply range from 10V to 20V
- Propagation delay matched to defined spec
- 3.3V, 5V and 15V logic input compatible
- RoHS compliant

Internal Electrical Schematic

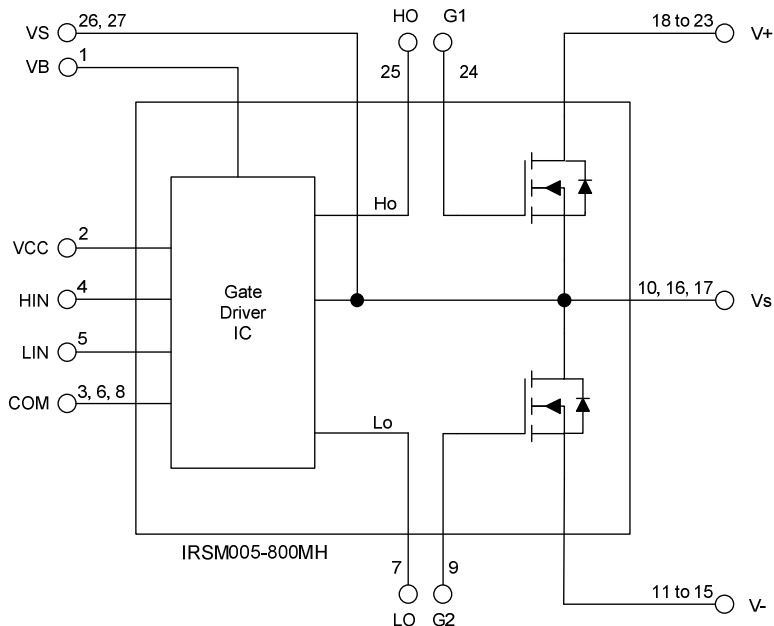

Ordering Information

Orderable Part Number	Package Type	Form	Quantity
IRSM005800MH	PQFN 7x8mm	Tray	1300
IRSM005800MHTR	PQFN 7x8mm	Tape and Reel	2000

Absolute Maximum Ratings

Absolute maximum ratings indicate sustained limits beyond which damage to the module may occur. These are not tested at manufacturing. All voltage parameters are absolute voltages referenced to V_{SS} unless otherwise stated in the table. The thermal resistance rating is measured under board mounted and still air conditions.

Symbol	Description	Min	Max	Unit
V_{DS}	MOSFET Drain-to-Source Voltage	---	40	V
I_o	Maximum DC current per MOSFET @ $T_C=25^\circ\text{C}$ (Note1)	---	80	A
P_d	Maximum Power dissipation per MOSFET @ $T_C=100^\circ\text{C}$	---	13	W
T_J (MOSFET & IC)	Maximum Operating Junction Temperature	---	150	$^\circ\text{C}$
T_S	Storage Temperature Range	-40	150	$^\circ\text{C}$
V_{GS}	Gate to Source voltage	+/- 20		V
V_B	High side floating absolute supply voltage	-0.3	225	
V_S	High side floating supply offset voltage	$V_B - 20$	$V_B + 0.3$	
V_{CC}	Low Side fixed supply voltage	-0.3	25	
V_{LO}	Low side output voltage	-0.3	$V_{CC} + 0.3\text{V}$	
V_{HO}	High side output voltage	-0.3	$V_{CC} + 0.3\text{V}$	
V_{IN}	Logic input voltage LIN, HIN	-0.3	$V_{CC} + 0.3\text{V}$	

Note1: Calculated based on maximum junction temperature. Bond wires current limit is 49A

Inverter Static Electrical Characteristics

V_{BIAS} (V_{CC} , V_{BS})=15V, $T_J=25^\circ\text{C}$, unless otherwise specified.

Symbol	Description	Min	Typ	Max	Units	Conditions	
$V_{(BR)DSS}$	Drain-to-Source Breakdown Voltage	40	---	---	V	$H_{IN}=L_{IN}=0\text{V}$, $I_D=250\mu\text{A}$	
$V_{GS(TH)}$	Gate Threshold Voltage	2	---	4	V	$I_D=100\mu\text{A}$	
$R_{DS(ON)}$	Drain-to-Source Voltage	---	2.7	5.0	m Ω	$I_D=10\text{A}$, $T_J=25^\circ\text{C}$	
		---	4.2			$I_D=10\text{A}$, $T_J=150^\circ\text{C}$	
I_{DSS}	Zero Gate Voltage Drain Current	---	---	20	μA	$H_{IN}=L_{IN}=0\text{V}$, $V^+=40\text{V}$	
		---	---	150		$H_{IN}=L_{IN}=0\text{V}$, $V^+=40\text{V}$, $T_J=125^\circ\text{C}$	
I_{GSS}	Gate to Source Forward Leakage	---	---	100	nA	$V_{GS}=20\text{V}$	
	Gate to Source Reverse Leakage	---	---	-100		$V_{GS}=-20\text{V}$	
R_G	Internal Gate Resistance	---	1.5	---	Ω		
V_{SD}	Mosfet Diode Forward Voltage Drop	---	0.8	0.9	V	$I_F=10\text{A}$	
		---	0.55			$I_F=10\text{A}$, $T_J=150^\circ\text{C}$	
RBSOA	Reverse Bias Safe Operating Area	FULL SQUARE, limited by T_{Jmax}					$V^+=40\text{V}$, $V_{CC}=+15\text{V}$ to 0V
$I_o @ T_A=60^\circ\text{C}$	RMS Phase Current, sinusoidal modulation, 5kHz	---	13.5	---	A_{RMS}	$V^+=32\text{V}$, $T_J=125^\circ\text{C}$, $MI=1$, $PF=0.8$, typical board mount. See Figure 2.	
$I_o @ T_A=60^\circ\text{C}$	RMS Phase Current, sinusoidal modulation, 20kHz	---	6	---	A_{RMS}		
EAS	Single Pulse Avalanche Energy	9.2	---	---	mJ		

Inverter Dynamic Electrical Characteristics
 $V_{BIAS} (V_{CC}, V_{BS})=15V, T_J=25^{\circ}C$, unless otherwise specified.

gfs	Forward Transconductance	159	---	---	S	$I_D=50A, V_{DS}=10V$
Q_G	Total Gate Charge	---	65	98	nC	$I_D=50A, V_{DS}=20V, V_{GS}=10V$
Q_{GS}	Gate to Source Charge	---	16	---		
Q_{GD}	Gate to Drain Charge	---	23	---		
Q_{SYNC}	Total Gate Charge Sync. ($Q_G - Q_{GD}$)	---	42	---		$I_D=50A, V_{DS}=0V, V_{GS}=10V$
T_{DON}	Mosfet Turn On Delay Time	---	11	---	ns	$I_D=30A, V_{DD}=20V, V_{GS}=10V, R_G=2.7\Omega$
T_R	Mosfet Rise Time	---	37	---		
T_{DOFF}	Mosfet Turn Off Delay Time	---	33	---		
T_F	Mosfet Fall Time	---	26	---		
C_{ISS}	Input Capacitance	---	3174	---	pF	F= 1.0MHz $V_{DS}=25V, V_{GS}=0V$
C_{OSS}	Output Capacitance	---	479	---		
C_{RSS}	Reverse Transfer Capacitance	---	332	---		
T_{RR}	Reverse Recovery Time	---	16	---	ns	$I_F=50A, V_R=34V, di/dt=100A/\mu s$
Q_{RR}	Reverse Recovery Charge	---	5	---	nC	
I_{RRM}	Reverse Recovery Current	---	0.5	---	A	

Recommended Operating Conditions Driver Function

For proper operation the device should be used within the recommended conditions. All voltages are absolute referenced to COM. The VS offset is tested with all supplies biased at 15V differential.

Symbol	Definition	Min	Typ	Max	Units
V_B	High side floating supply voltage	V_S+10	V_S+15	V_S+20	V
V_S	High side floating supply offset voltage	Note 1	---	40	V
V_{CC}	Low side and logic fixed supply voltage	10	15	20	V
V_{IN}	Logic input voltage LIN, HIN	COM	---	V_{CC}	V
HIN	High side PWM pulse width	1	---	---	μs
Deadtime	Suggested dead time between HIN and LIN	0.3	0.5	---	μs

Static Electrical Characteristics Driver Function

V_{BIAS} (V_{CC} , V_{BS})=15V, $T_J=25^{\circ}C$, unless otherwise specified. The V_{IN} , and I_{IN} parameters are referenced to COM

Symbol	Definition	Min	Typ	Max	Units	Test Conditions
V_{IH}	Positive going input threshold for LIN, HIN	2.5	---	---	V	$V_{CC}=10$ to 20V $I_O=2mA$
V_{IL}	Negative going input threshold for LIN, HIN	---	---	0.8		
V_{OH}	High Level Output Voltage	---	0.05	0.2		
V_{OL}	Low Level Output Voltage	---	0.02	0.1		
V_{CCUV+} V_{BSUV+}	V_{CC}/V_{BS} supply undervoltage, Positive going threshold	8.0	8.9	9.8		
V_{CCUV-} V_{BSUV-}	V_{CC}/V_{BS} supply undervoltage, Negative going threshold	7.4	8.2	9.0		
V_{CCUVH} V_{BSUH}	V_{CC}/V_{BS} supply undervoltage lock-out hysteresis	---	0.8	---		
I_{LK}	Offset Supply Leakage Current	---	---	50	μA	$V_B=V_S=200V$ $V_{IN}=0V$ or 5V
I_{QBS}	Quiescent V_{BS} supply current	---	45	75		
I_{QCC}	Quiescent V_{CC} supply current	---	250	500		
I_{IN+}	Input bias current $V_{IN}=5V$ for LIN, HIN	---	4	10		
I_{IN-}	Input bias current $V_{IN}=0V$ for LIN, HIN	---	0.5	1		
I_{O+}	IC high output short circuit current	200	290	---	mA	$V_O=0V$, $V_{IN}=5V$, $PW < 10\mu s$
I_{O-}	IC low output short circuit current	420	600	---		

Dynamic Electrical Characteristics Driver Function

V_{BIAS} (V_{CC} , V_{BS})=15V, $T_J=25^{\circ}C$ unless otherwise specified, $C_L = 1000$ pF, Driver only timing.

Symbol	Description	Min	Typ	Max	Units	Conditions
T_R	IC Turn on Rise Time	---	50	150	ns	
T_F	IC Turn off Fall Time	---	35	90		
T_{ON}	IC Input to Output propagation turn-on delay time	---	160	220		
T_{OFF}	IC Input to Output propagation turn-off delay time	---	150	220		
MT	IC Delay matching, HS and LS turn-on/off	---	---	50		

Thermal and Mechanical Characteristics

Symbol	Description	Min	Typ	Max	Units	Conditions
$R_{th(J-B)}$	Thermal resistance, junction to mounting pad, each MOSFET	---	3.8	---	°C/W	Standard reflow-solder process
$R_{th(J-A)}$	Thermal resistance, junction to ambient, each MOSFET	---	40	---	°C/W	Mounted on 50mm ² of four-layer FR4 with 28 vias

Input-Output Logic Level Table

HIN	LIN	U,V,W
HI	HI	Shoot-through
LO	LO	**
HI	LO	V+
LO	HI	0

* V+ if motor current is flowing into VS, 0 if current is flowing out of VS into the motor winding

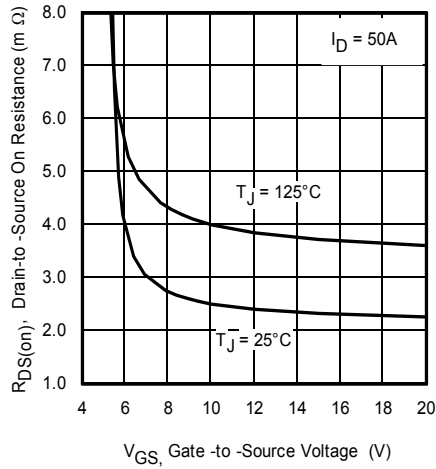

Fig. 1 Typical On Resistance vs Gate Voltage

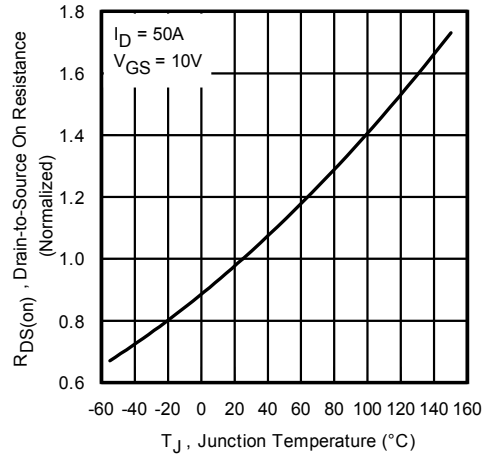

Fig.2 Normalized On Resistance vs Temperature

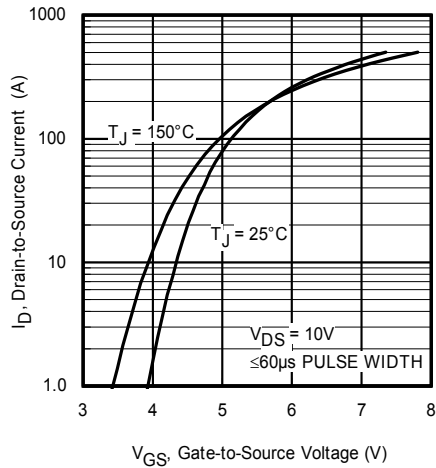

Fig. 3 Typical Transfer Characteristic

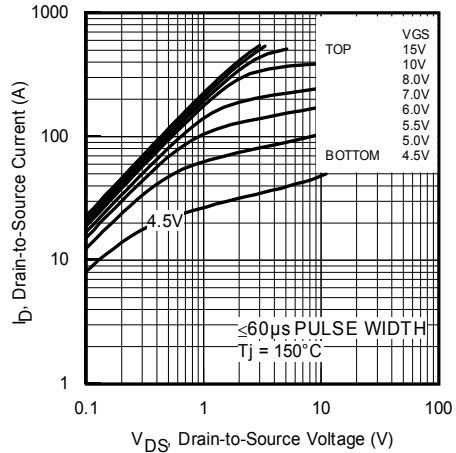

Fig.4 Typical Output Characteristic @ 150C

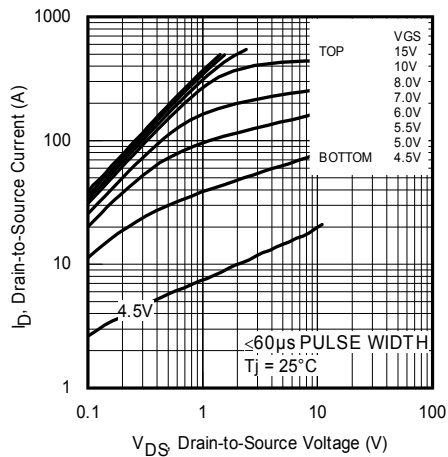

Fig. 5 Typical Output Characteristic @ 25C

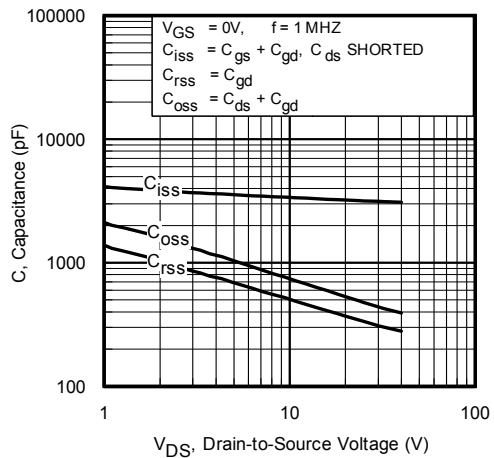

Fig. 6 Typical Capacitance vs Drain to Source Voltage

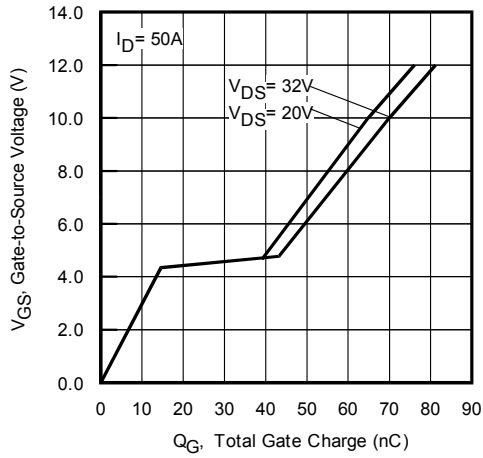

Fig. 7 Typical Gate Charge vs Gate Voltage

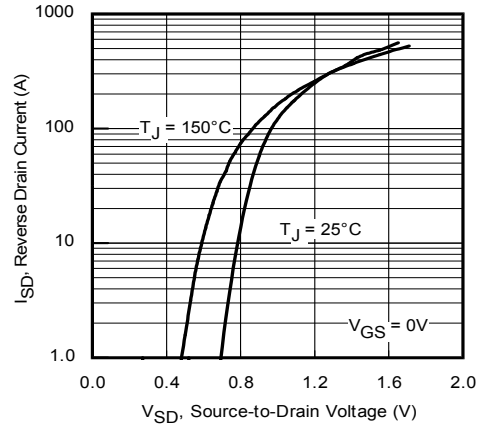

Fig.8 Typical Diode Forward Voltage Drop

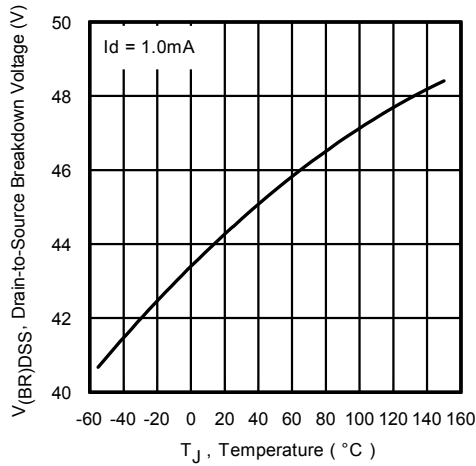

Fig. 9 Typical Breakdown Voltage vs Temperature

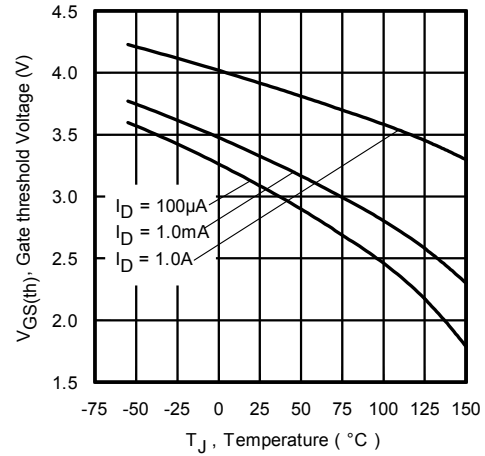

Fig.10 Threshold Voltage vs Temperature

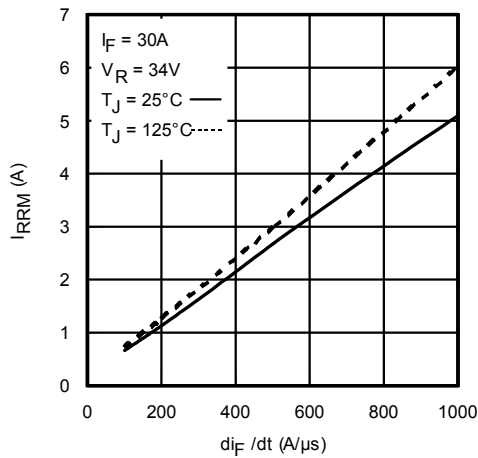

Fig. 11 Typical Recovery Current vs di/dt

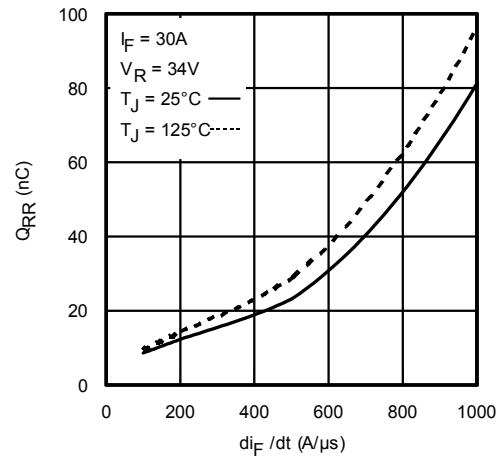
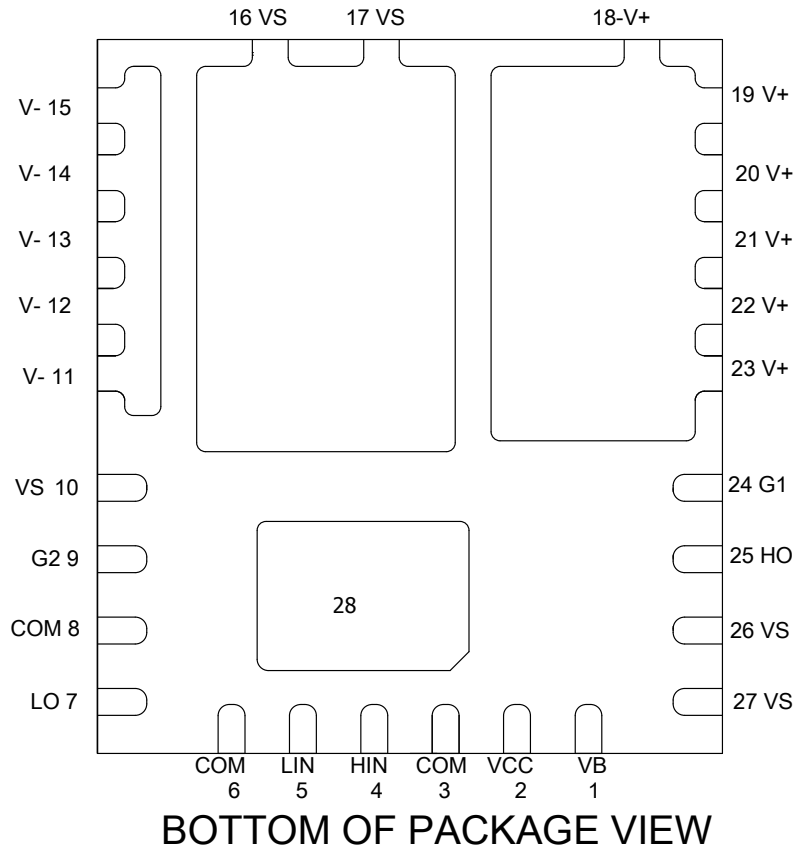

Fig. 12 Typical Recovery Charge vs Temperature

Module Pin-Out Description

Pin	Name	Description
3, 6, 8	COM	Negative of Gate Drive Supply Voltage
2	V _{CC}	15V Gate Drive Supply
4	HIN	Logic Input for High Side (Active High)
5	LIN	Logic Input for Low Side (Active High)
7	LO	Low Side FET Gate
9	G2	Low Side Gate Drive Output
10, 16, 17	V _S	Phase Output
11 – 15	V-	Low Side Source Connection
18 – 23	V+	DC Bus
24	G1	High Side Gate Drive Output
25	HO	High Side FET Gate
26 – 27	V _S	Negative of Bootstrap Supply
1	V _B	Positive of Bootstrap Supply



Exposed pad (Pin 28) has to be connected to COM for better electrical performance

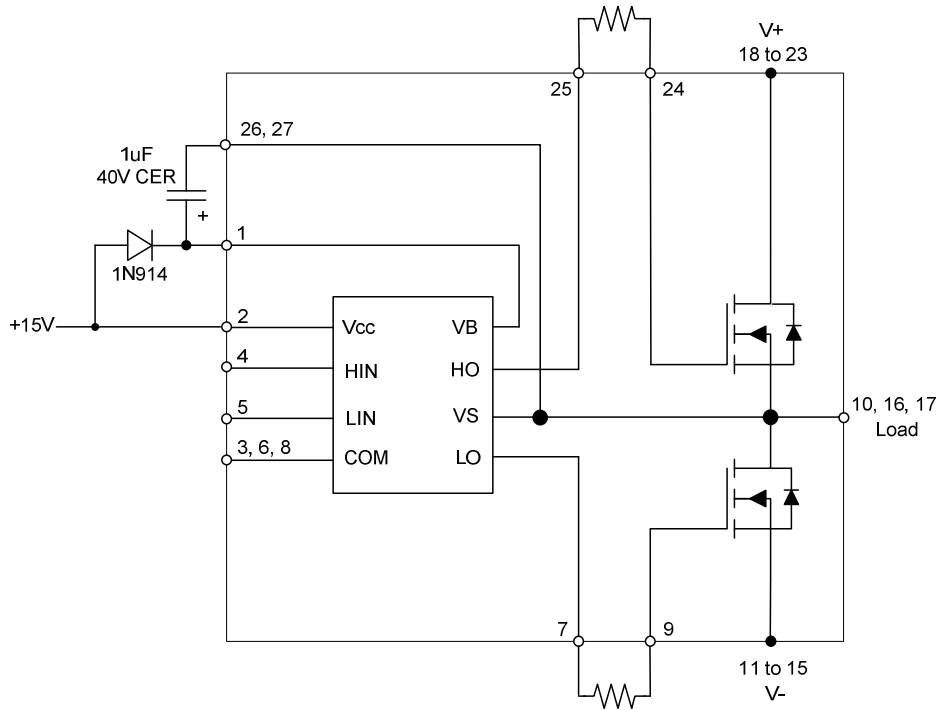

Figure 13: Typical Application Connection

1. Bus capacitors should be mounted as close to the module bus terminals as possible to reduce ringing and EMI problems. Additional high frequency ceramic capacitor mounted close to the module pins will further improve performance.
2. Value of the boot-strap capacitors depends upon the switching frequency. Their selection should be made based on IR Design tip DT04-4 or application note AN-1044.

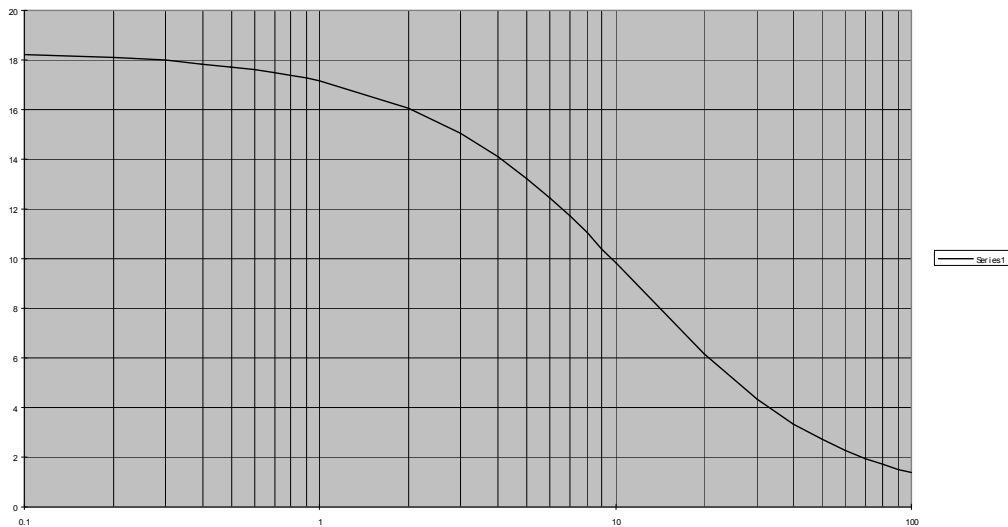

Figure 14: Typical Output Current (RMS of fundamental) vs. Modulation Frequency
Sinusoidal Modulation, $V^+ = 32V$, $T_J = 125^\circ C$, $T_A = 60^\circ C$, $M_I = 1$, $PF = 0.8$, mounted on 50 mm^2 of FR4

Qualification

Qualification Level		Industrial ^{††} (per JEDEC JESD 47E)
Moisture Sensitivity Level		MSL3 ^{†††} (per IPC/JEDEC J-STD-020C)
ESD	Machine Model	Class B (±200V) (per JEDEC standard JESD22-A115A)
	Human Body Model	Class 1C (±1000V) (per EIA/JEDEC standard EIA/JES-001A-2011)
RoHS Compliant		Yes

† Qualification standards can be found at International Rectifier's web site <http://www.irf.com/>

†† Higher qualification ratings may be available should the user have such requirements. Please contact your International Rectifier sales representative for further information.

††† Higher MSL ratings may be available for the specific package types listed here. Please contact your International Rectifier sales representative for further information.

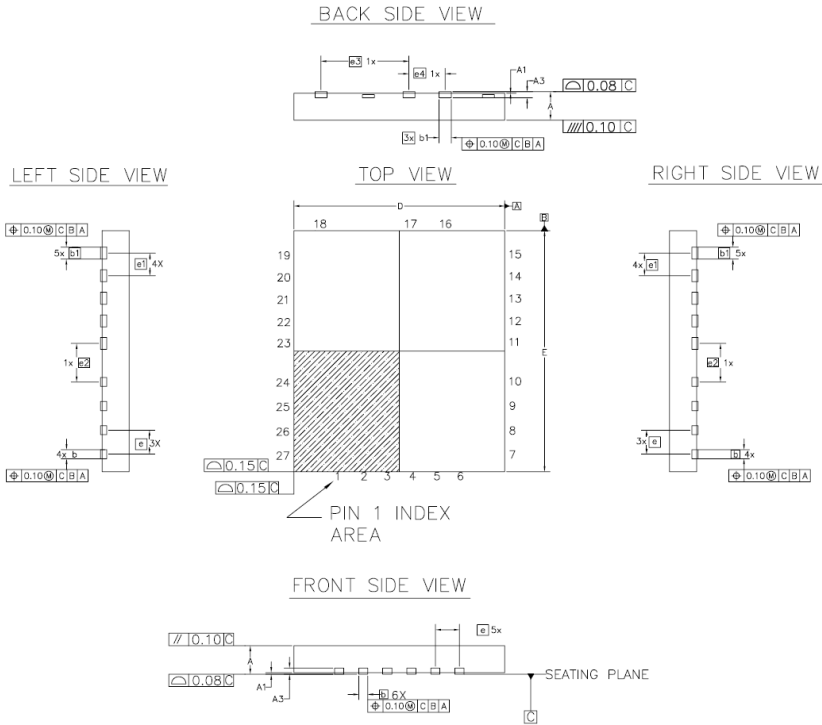
Package Outline (Top & Side view)

SYMBOL	DIMENSIONS IN MILLIMETER		
	MIN.	NOM.	MAX.
A	0.800	0.900	1.000
A1	0.000	—	0.050
A3	0.203 REF.		
b	0.250	0.300	0.350
b1	0.350	0.400	0.450
D	6.900	7.000	7.100
E	7.900	8.000	8.100
D2	2.323	2.373	2.423
E2	1.748	1.798	1.848
D3	2.290	2.340	2.390
E3	4.144	4.194	4.244
D4	2.698	2.748	2.798
E4	4.267	4.317	4.367
e	0.800 BSC		
e1	0.750 BSC		
e2	1.281 BSC		
e3	2.918 BSC		
e4	1.200 BSC		
L	0.500	0.550	0.600
L1	0.253	0.303	0.353

Package Outline (Bottom View, 1 of 2)

PACKAGE BOTTOM VIEW

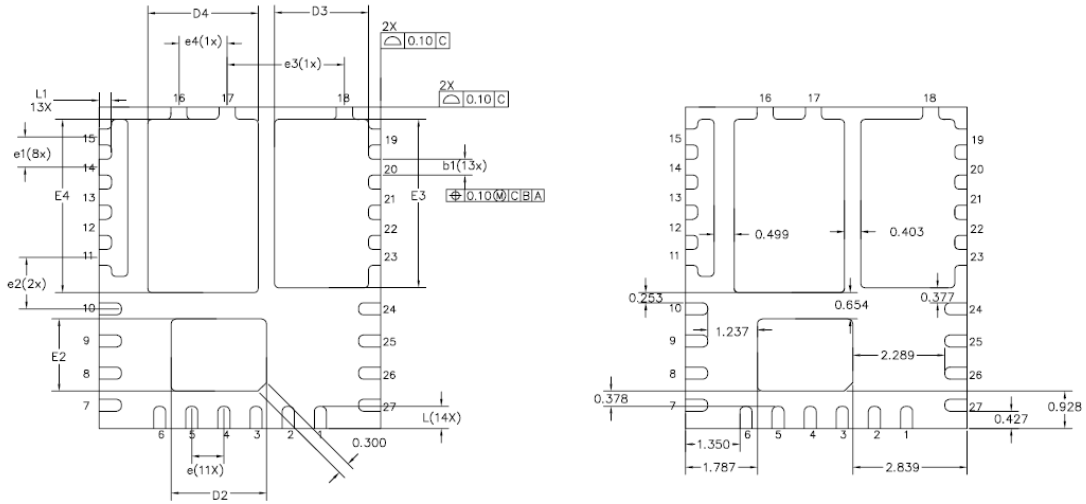

SYMBOL	DIMENSIONS IN MILLIMETER		
	MIN.	NOM.	MAX.
A	0.800	0.900	1.000
A1	0.000	—	0.050
A3	0.203 REF.		
b	0.250	0.300	0.350
b1	0.350	0.400	0.450
D	6.900	7.000	7.100
E	7.900	8.000	8.100
D2	2.323	2.373	2.423
E2	1.748	1.798	1.848
D3	2.290	2.340	2.390
E3	4.144	4.194	4.244
D4	2.698	2.748	2.798
E4	4.267	4.317	4.367
e	0.800 BSC		
e1	0.750 BSC		
e2	1.281 BSC		
e3	2.918 BSC		
e4	1.200 BSC		
L	0.500	0.550	0.600
L1	0.253	0.303	0.353

1. For mounting instruction see AN-1178.
2. For recommended PCB via design see AN-1091.
3. For recommended design, solder profile, integration and rework guidelines see AN-1028.
4. For board inspection guidelines see AN-1133.

Tape and Reel Details

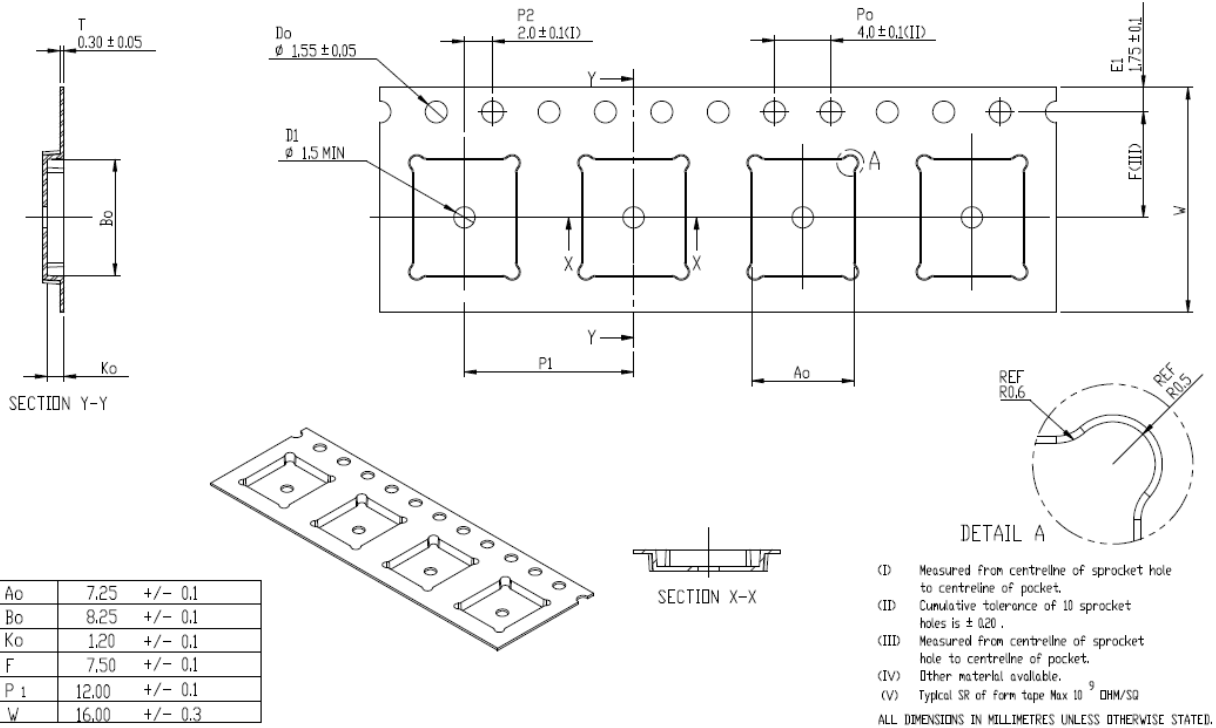

International
 Rectifier

Data and Specifications are subject to change without notice
IR WORLD HEADQUARTERS: 233 Kansas St., El Segundo, California 90245, USA Tel: (310) 252-7105
TAC Fax: (310) 252-7903
Visit us at www.irf.com for sales contact information

Mouser Electronics

Authorized Distributor

Click to View Pricing, Inventory, Delivery & Lifecycle Information:

[Infineon:](#)

[IRSM005-800MHTR](#) [IRSM005-800MH](#)