

DATA SHEET

SURFACE-MOUNT CERAMIC MULTILAYER CAPACITORS

General Purpose & High Capacitance

Class 2, X7R

6.3 V TO 50 V

100 pF to 22 μ F

RoHS compliant & Halogen Free



SCOPE

This specification describes X7R series chip capacitors with lead-free terminations.

APPLICATIONS

PCs, Hard disk, Game PCs
 DVDs, Video cameras
 Mobile phones
 Data processing

FEATURES

Supplied in tape on reel
 Nickel-barrier end termination
 RoHS compliant
 Halogen Free compliant

ORDERING INFORMATION-GLOBAL PART NUMBER, PHYCOMP

CTC & I2NC

All part numbers are identified by the series, size, tolerance, TC material, packing style, voltage, process code, termination and capacitance value.

YAGEO BRAND ordering code

GLOBAL PART NUMBER (PREFERRED)

CC xxxx x x **X7R** x **BB** xxx
 (1) (2) (3) (4) (5)

(1) SIZE – INCH BASED (METRIC)

- 0201 (0603)
- 0402 (1005)
- 0603 (1608)
- 0805 (2012)
- 1206 (3216)
- 1210 (3225)
- 1812 (4532)

(2) TOLERANCE

- J = ±5% ⁽¹⁾
- K = ±10%
- M = ±20%

(3) PACKING STYLE

- R = Paper/PE taping reel; Reel 7 inch
- K = Blister taping reel; Reel 7 inch
- P = Paper/PE taping reel; Reel 13 inch
- F = Blister taping reel; Reel 13 inch
- C = Bulk case

(4) RATED VOLTAGE

- 5 = 6.3 V
- 6 = 10 V
- 7 = 16 V
- 8 = 25 V
- 9 = 50 V

(5) CAPACITANCE VALUE

2 significant digits+number of zeros
 The 3rd digit signifies the multiplying factor, and letter R is decimal point
 Example: 103 = 10 × 10³ = 10,000 pF = 10 nF

NOTE

I. Tolerance ±5% is not available for full product range, please contact local sales force before ordering

CONSTRUCTION

The capacitor consists of a rectangular block of ceramic dielectric in which a number of interleaved metal electrodes are contained. This structure gives rise to a high capacitance per unit volume.

The inner electrodes are connected to the two end terminations and finally covered with a layer of plated tin (NiSn). The terminations are lead-free. A cross section of the structure is shown in Fig.1.

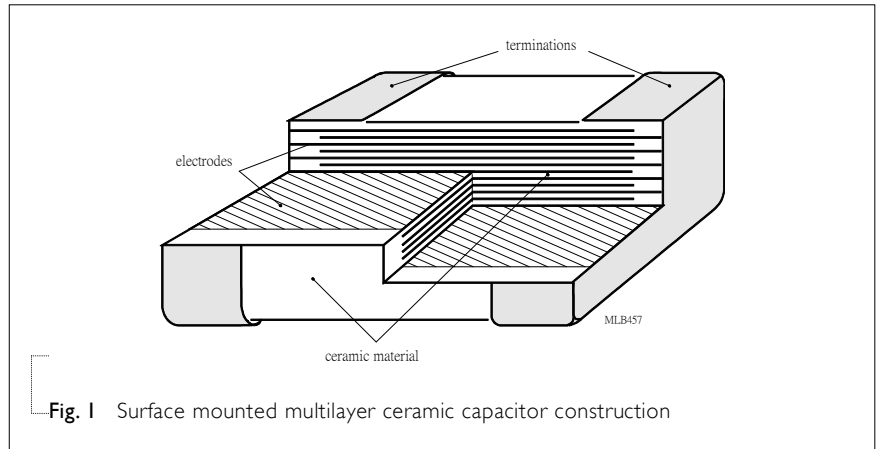

Fig. 1 Surface mounted multilayer ceramic capacitor construction

DIMENSION

Table I For outlines see fig. 2

TYPE	L ₁ (mm)	W (mm)	T (MM)	L ₂ / L ₃ (mm)		L ₄ (mm)
				min.	max.	min.
0201	0.6 ±0.03	0.3 ±0.03	Refer to table 2 to 4	0.10	0.20	0.20
0402	1.0 ±0.05	0.5 ±0.05		0.15	0.30	0.40
0603	1.6 ±0.10 ⁽¹⁾	0.8 ±0.10 ⁽¹⁾		0.20	0.60	0.40
	1.6 ±0.15 ⁽²⁾	0.8 ±0.15 ⁽²⁾				
0805	2.0 ±0.10 ⁽¹⁾	1.25 ±0.10 ⁽¹⁾		0.25	0.75	0.55
	2.0 ±0.20 ⁽²⁾	1.25 ±0.20 ⁽²⁾				
1206	3.2 ±0.15 ⁽¹⁾	1.6 ±0.15 ⁽¹⁾		0.25	0.75	1.40
	3.2 ±0.30 ⁽²⁾	1.6 ±0.20 ⁽²⁾				
1210	3.2 ±0.20 ⁽¹⁾	2.5 ±0.20 ⁽¹⁾		0.25	0.75	1.40
	3.2 ±0.40 ⁽²⁾	2.5 ±0.30 ⁽²⁾				
1812	4.5 ±0.20 ⁽¹⁾	3.2 ±0.20 ⁽¹⁾	0.25	0.75	2.20	
	4.5 ±0.40 ⁽²⁾	3.2 ±0.40 ⁽²⁾				

OUTLINES

For dimension see Table I

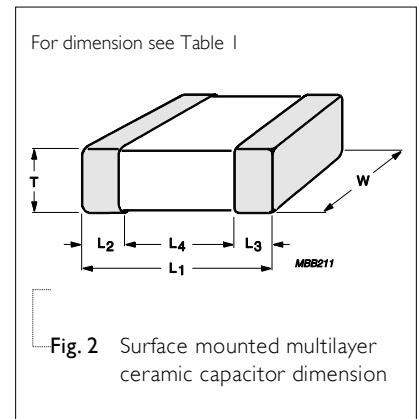

Fig. 2 Surface mounted multilayer ceramic capacitor dimension

NOTE

1. Dimension for size 0603, C < 2.2 μF; 0805 to 1812, C ≤ 100nF
2. Dimension for size 0603, C = 1 μF; 50V; 0805 to 1812, C > 100 nF

CAPACITANCE RANGE & THICKNESS FOR X7R

Table 2 Sizes from 0201 to 0402

CAP.	0201					0402				
	6.3 V	10 V	16 V	25 V	50 V	6.3 V	10 V	16 V	25 V	50 V
100 pF										
150 pF										
220 pF										
330 pF					0.3±0.03					
470 pF										
680 pF										
1.0 nF	0.3±0.03	0.3±0.03	0.3±0.03	0.3±0.03						
1.5 nF										
2.2 nF										0.5±0.05
3.3 nF						0.5±0.05	0.5±0.05	0.5±0.05	0.5±0.05	
4.7 nF										
6.8 nF										
10 nF										
15 nF										
22 nF										
33 nF										
47 nF										
68 nF										
100 nF										0.5±0.05
150 nF										
220 nF						0.5±0.05	0.5±0.05	0.5±0.05		
330 nF										
470 nF						0.5±0.05	0.5±0.05			
680 nF										
1.0 µF						0.5±0.05				
2.2 µF										
4.7 µF										
10 µF										
22 µF										

NOTE

1. Values in shaded cells indicate thickness class in mm
2. Capacitance value of non E-6 series is on request
3. For product with 5% tolerance, please contact local sales force before ordering

CAPACITANCE RANGE & THICKNESS FOR X7R

Table 3 Sizes from 0603 to 0805

CAP.	0603					0805				
	6.3 V	10 V	16 V	25 V	50 V	6.3 V	10 V	16 V	25 V	50 V
100 pF										
150 pF										
220 pF										
330 pF										
470 pF										
680 pF										
1.0 nF										
1.5 nF										
2.2 nF						0.6±0.1	0.6±0.1	0.6±0.1	0.6±0.1	0.6±0.1
3.3 nF										
4.7 nF					0.8±0.1					
6.8 nF										
10 nF	0.8±0.1	0.8±0.1	0.8±0.1	0.8±0.1						
15 nF										
22 nF										
33 nF										
47 nF										
68 nF						0.85±0.1	0.85±0.1	0.85±0.1	0.85±0.1	0.85±0.1
100 nF										
150 nF										
220 nF										
330 nF										
470 nF										
680 nF										
1.0 µF					0.8±0.15	1.25±0.2	1.25±0.2	1.25±0.2	1.25±0.2	1.25±0.2
2.2 µF										
4.7 µF										
10 µF										
22 µF										

NOTE

1. Values in shaded cells indicate thickness class in mm
2. Capacitance value of non E-6 series is on request
3. For product with 5% tolerance, please contact local sales force before ordering

CAPACITANCE RANGE & THICKNESS FOR X7R

Table 4 Size 1206

CAP.	1206				
	6.3 V	10 V	16 V	25 V	50 V
100 pF					
150 pF					
220 pF					
330 pF					
470 pF					
680 pF					
1.0 nF					
1.5 nF					
2.2 nF					
3.3 nF					
4.7 nF					0.85±0.1
6.8 nF	0.85±0.1	0.85±0.1	0.85±0.1	0.85±0.1	
10 nF					
15 nF					
22 nF					
33 nF					
47 nF					
68 nF					
100 nF					
150 nF					0.85±0.1 / 1.15±0.1
220 nF					
330 nF				0.85±0.1 / 1.15±0.1	0.85±0.1
470 nF				0.85±0.1	1.0±0.1
680 nF					
1.0 µF	1.15±0.1	1.15±0.1	1.15±0.1	1.15±0.1	
2.2 µF					1.6±0.2
4.7 µF				1.6±0.2	
10 µF	1.6±0.2	1.6±0.2			
22 µF					
47 µF					

NOTE

1. Values in shaded cells indicate thickness class in mm
2. Capacitance value of non E-6 series is on request
3. For product with 5% tolerance, please contact local sales force before ordering
4. Please contact local sales force for special ordering code before ordering

CAPACITANCE RANGE & THICKNESS FOR X7R

Table 5 Sizes from 1210 to 1812

CAP.	1210 6.3 V	10 V	16 V	25 V	50 V	1812 50 V
100 pF						
150 pF						
220 pF						
330 pF						
470 pF						
680 pF						
1.0 nF						
1.5 nF						
2.2 nF						
3.3 nF						
4.7 nF						
6.8 nF						
10 nF						
15 nF					0.85±0.1	0.85±0.1
22 nF	0.85±0.1	0.85±0.1	0.85±0.1	0.85±0.1		
33 nF						
47 nF						
68 nF						
100 nF						
150 nF						
220 nF					1.15±0.1	1.15±0.1
330 nF						
470 nF	1.15±0.1	1.15±0.1	1.15±0.1	1.15±0.1		
680 nF					1.25±0.2	1.6±0.2
1.0 µF	1.25±0.2	1.25±0.2	1.25±0.2	1.25±0.2		
2.2 µF					1.9±0.2	
4.7 µF	1.9±0.2	1.9±0.2	1.9±0.2	1.9±0.2		
10 µF					2.5±0.3	
22 µF	2.5±0.2	2.5±0.2	2.5±0.2	2.5±0.2		
47 µF						

NOTE

1. Values in shaded cells indicate thickness class in mm
2. Capacitance value of non E-6 series is on request
3. For product with 5% tolerance, please contact local sales force before ordering
4. Please contact local sales force for special ordering code before ordering

THICKNESS CLASSES AND PACKING QUANTITY

Table 6

SIZE CODE	THICKNESS CLASSIFICATION	TAPE WIDTH QUANTITY PER REEL	Ø180 MM / 7 INCH		Ø330 MM / 13 INCH		QUANTITY PER BULK CASE
			Paper	Blister	Paper	Blister	
0201	0.3 ±0.03 mm	8 mm	15,000	---	50,000	---	---
0402	0.5 ±0.05 mm	8 mm	10,000	---	50,000	---	50,000
0603	0.8 ±0.1 mm	8 mm	4,000	---	15,000	---	15,000
0805	0.6 ±0.1 mm	8 mm	4,000	---	20,000	---	10,000
	0.85 ±0.1 mm	8 mm	4,000	---	15,000	---	8,000
1206	1.25 ±0.2 mm	8 mm	---	3,000	---	10,000	5,000
	0.6 ±0.1 mm	8 mm	4,000	---	20,000	---	---
	0.85 ±0.1 mm	8 mm	4,000	---	15,000	---	---
	1.00 / 1.15 ±0.1 mm	8 mm	---	3,000	---	10,000	---
	1.25 ±0.2 mm	8 mm	---	3,000	---	10,000	---
	1.6 ±0.15 mm	8 mm	---	2,500	---	10,000	---
1210	1.6 ±0.2 mm	8 mm	---	2,000	---	8,000	---
	0.6 / 0.7 ±0.1 mm	8 mm	---	4,000	---	15,000	---
	0.85 ±0.1 mm	8 mm	---	4,000	---	10,000	---
	1.15 ±0.1 mm	8 mm	---	3,000	---	10,000	---
	1.15 ±0.15 mm	8 mm	---	3,000	---	10,000	---
	1.25 ±0.2 mm	8 mm	---	3,000	---	---	---
	1.5 ±0.1 mm	8 mm	---	2,000	---	---	---
	1.6 / 1.9 ±0.2 mm	8 mm	---	2,000	---	---	---
1808	2.0 ±0.2 mm	8 mm	---	2,000 1,000	---	---	---
	2.5 ±0.2 mm	8 mm	---	1,000 500	---	---	---
	1.15 ±0.15 mm	12 mm	---	3,000	---	---	---
	1.25 ±0.2 mm	12 mm	---	3,000	---	---	---
	1.35 ±0.15 mm	12 mm	---	2,000	---	---	---
	1.5 ±0.1 mm	12 mm	---	2,000	---	---	---
1812	1.6 ±0.2 mm	12 mm	---	2,000	---	8,000	---
	2.0 ±0.2 mm	12 mm	---	2,000	---	---	---
	0.6 / 0.85 ±0.1 mm	12 mm	---	2,000	---	---	---
	1.15 ±0.1 mm	12 mm	---	1,000	---	---	---
	1.25 ±0.2 mm	12 mm	---	1,000	---	---	---
	1.5 ±0.1 mm	12 mm	---	1,000	---	---	---
	1.6 ±0.2 mm	12 mm	---	1,000	---	---	---
2.0 ±0.2 mm	12 mm	---	1,000	---	---	---	
2.5 ±0.2 mm	12 mm	---	500	---	---	---	

ELECTRICAL CHARACTERISTICS

X7R DIELECTRIC CAPACITORS; NISN TERMINATIONS

Unless otherwise specified, all test and measurements shall be made under standard atmospheric conditions for testing as given in 5.3 of IEC 60068-1:

- Temperature: 15 °C to 35 °C
- Relative humidity: 25% to 75%
- Air pressure: 86 kPa to 106 kPa

Before the measurements are made, the capacitor shall be stored at the measuring temperature for a time sufficient to allow the entire capacitor to reach this temperature.

The period as prescribed for recovery at the end of a test is normally sufficient for this purpose.

Table 7

DESCRIPTION				VALUE	
Capacitance range				100 pF to 47 μF	
Capacitance tolerance				±5%, ±10%, ±20%	
Dissipation factor (D.F.)					
≤ 10 V	47pF ≤ 0201 ≤ 10nF	100pF ≤ 0402 ≤ 100nF	100pF ≤ 0603 ≤ 1μF	≤ 5%	
	150pF ≤ 0805 ≤ 2.2μF	220 pF ≤ 1206 ≤ 2.2μF	2.2nF ≤ 1210 ≤ 2.2μF		
	Exception: 220nF ≤ 0402 ≤ 470nF 0603 = 2.2μF 0805 ≥ 4.7 μF			≤ 10%	
	1206 ≥ 4.7μF	4.7μF ≤ 1210 ≤ 47μF	0201 ≥ 12 nF		
	0402 = 1μF			≤ 12.5%	
16 V	47 pF ≤ 0201 ≤ 1.2nF	100 pF ≤ 0402 ≤ 22nF	100 pF ≤ 0603 ≤ 470nF	≤ 3.5%	
	150 pF ≤ 0805 ≤ 560nF	220pF ≤ 1206 ≤ 1μF	2.2nF ≤ 1210 ≤ 1μF		
	Exception: 1.5 nF ≤ 0201 ≤ 10nF 27nF ≤ 0402 ≤ 100nF 680 nF ≤ 0805 ≤ 2.2μF			≤ 5%	
	1206 = 2.2 μF	2.2μF ≤ 1210 ≤ 10 μF	470 nF < 0603 ≤ 1uF		
	0402 = 220 nF	4.7 μF ≤ 0805 ≤ 10μF	4.7μF ≤ 1206 ≤ 10μF	≤ 10%	
	1210 = 22μF				
25 V	47pF ≤ 0201 ≤ 470pF	100pF ≤ 0402 ≤ 10nF	100pF ≤ 0603 ≤ 39nF	≤ 2.5%	
	150pF ≤ 0805 ≤ 180nF	220pF ≤ 1206 ≤ 680nF	2.2nF ≤ 1210 ≤ 1μF		
	Exception: 12 nF ≤ 0402 ≤ 47nF 47nF ≤ 0603 ≤ 220nF 220nF ≤ 0805 ≤ 560 nF			≤ 3.5%	
	1206 = 1μF				
	560pF ≤ 0201 ≤ 10nF	56 nF ≤ 0402 ≤ 100 nF	680nF ≤ 0805 ≤ 1μF	≤ 5%	
	1206 = 2.2μF	2.2μF ≤ 1210 ≤ 10 μF			
	270nF ≤ 0603 ≤ 1uF	2.2uF ≤ 0805 ≤ 4.7uF	1206 ≥ 4.7uF	≤ 10%	
	1210 ≥ 22uF				
≥ 50 V				≤ 2.5%	
	Exception: 0201 ≥ 47pF			1μF ≥ 1206 ≥ 680nF	≤ 3.5%
	0603 ≥ 47nF			47nF ≥ 0402 ≥ 12 nF 470nF ≥ 0805 ≥ 330 nF	≤ 3.0%
	0402 = 100nF			0805 = 680 nF	≤ 5%
	0603 ≥ 1μF			0805 ≥ 1μF 1206 ≥ 2.2μF	≤ 10%
1210 ≥ 2.2μF					

Insulation resistance after 1 minute at U_r (DC) $R_{ins} \geq 10 \text{ G}\Omega$ or $R_{ins} \times C_r \geq 500(100)$ seconds whichever is less

Maximum capacitance change as a function of temperature (temperature characteristic/coefficient): $\pm 15\%$

Operating temperature range: $-55 \text{ }^\circ\text{C}$ to $+125 \text{ }^\circ\text{C}$

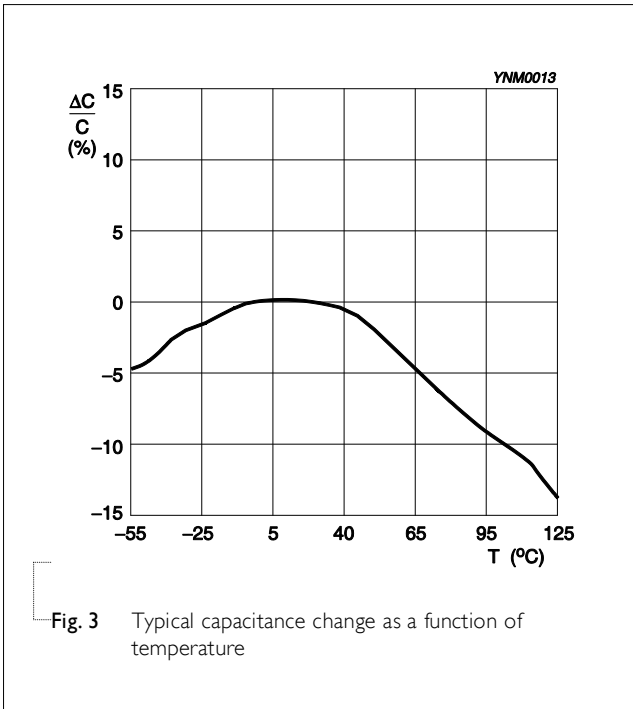

Size 0201 10 nF / 16 V
Solid lines: Impedance / Dotted lines: ESR

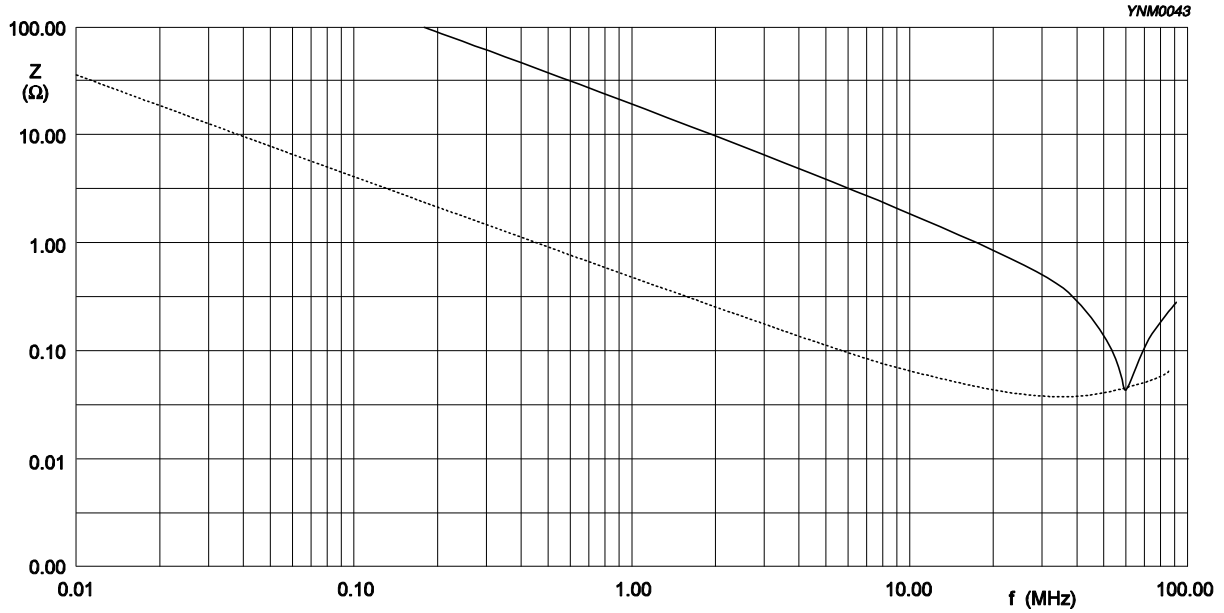

Fig. 4 Impedance ESR vs. frequency characteristics for multilayer chip capacitors

Size 0402 100 nF / 16 V
Solid lines: Impedance / Dotted lines: ESR

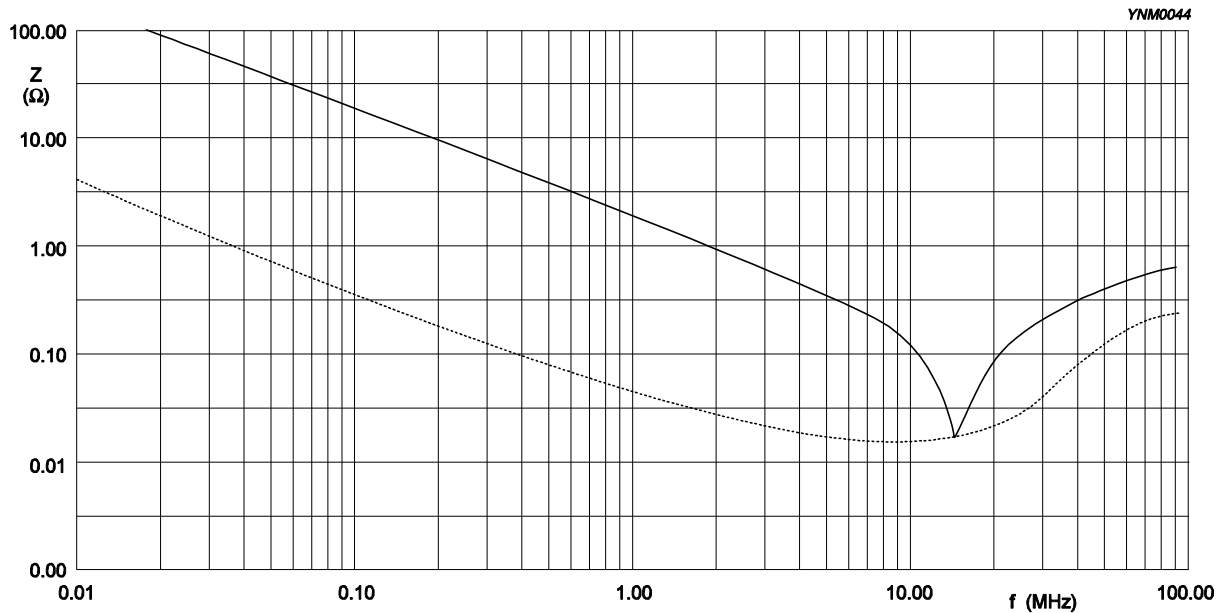

Fig. 5 Impedance ESR vs. frequency characteristics for multilayer chip capacitors

Size 0603 1 μ F / 16 V
Solid lines: Impedance / Dotted lines: ESR

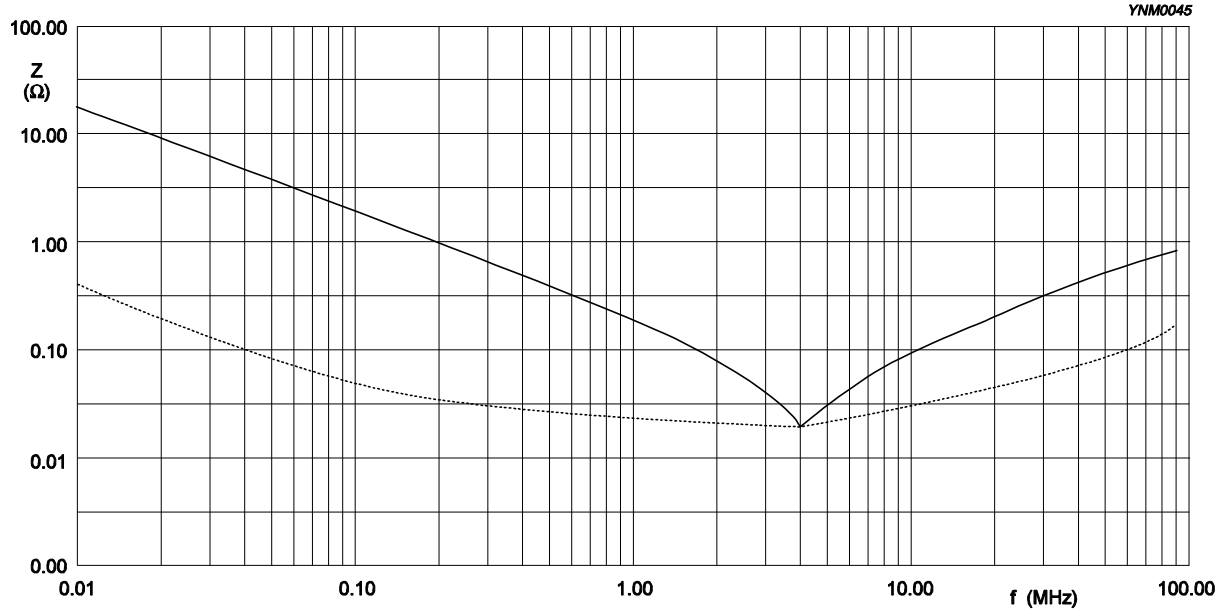

Fig. 6 Impedance ESR vs. frequency characteristics for multilayer chip capacitors

Size 0805 1 μ F / 16 V
Solid lines: Impedance / Dotted lines: ESR

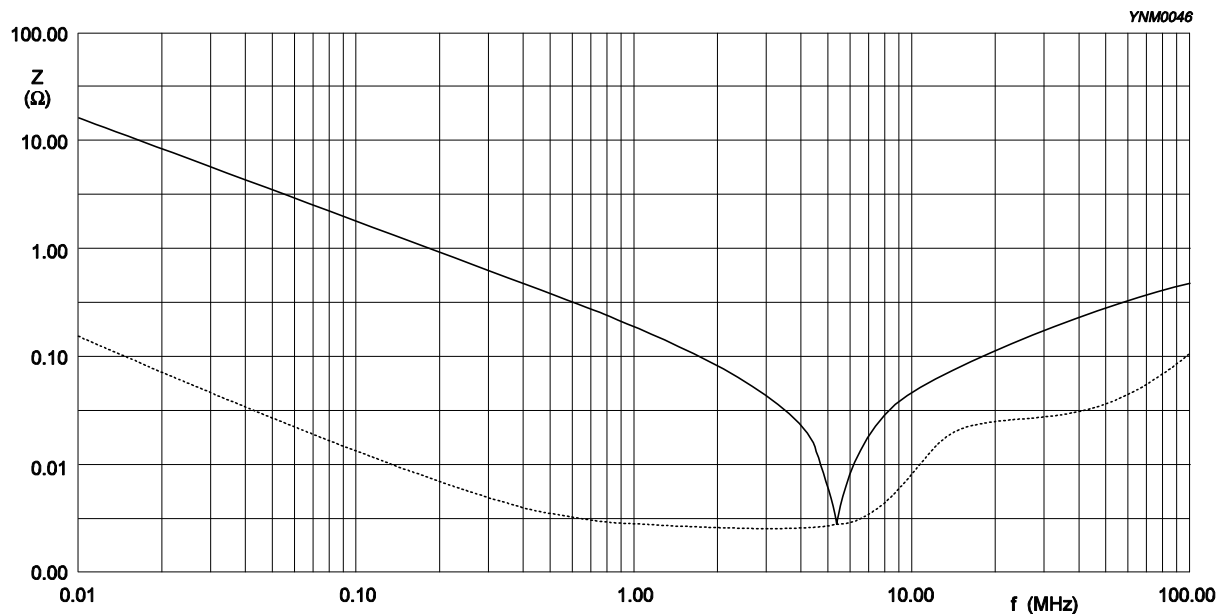

Fig. 7 Impedance ESR vs. frequency characteristics for multilayer chip capacitors

Size: 1206 1 μ F / 25 V
Solid lines: Impedance / Dotted lines: ESR

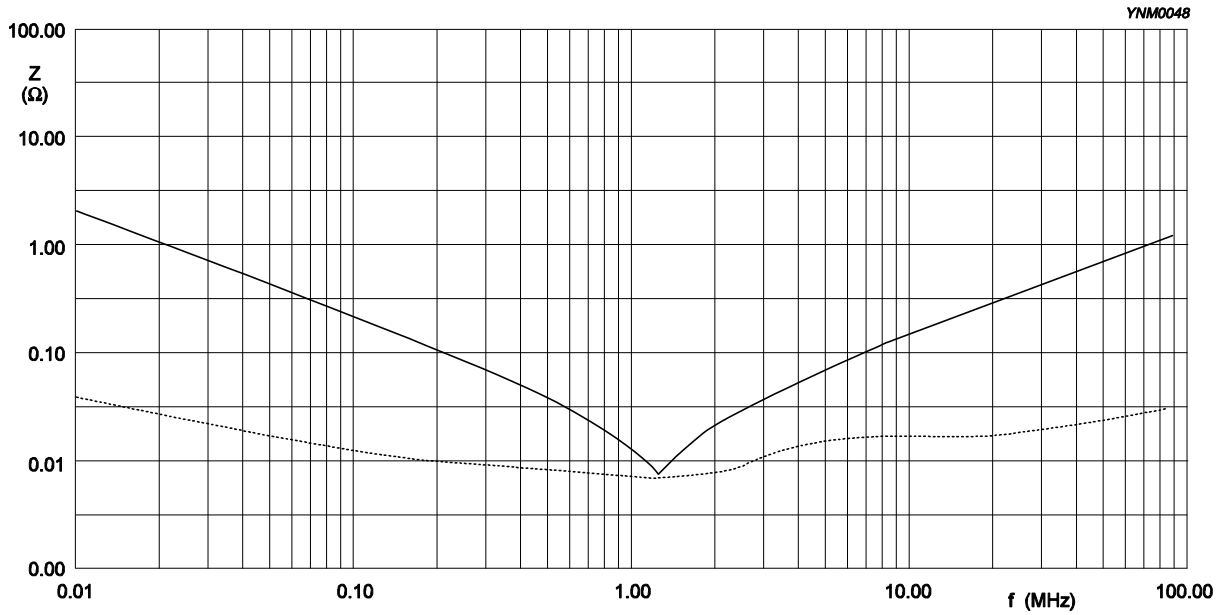

Fig. 8 Impedance ESR vs. frequency characteristics for multilayer chip capacitors

Size: 1206 10 μ F / 10 V
Solid lines: Impedance / Dotted lines: ESR

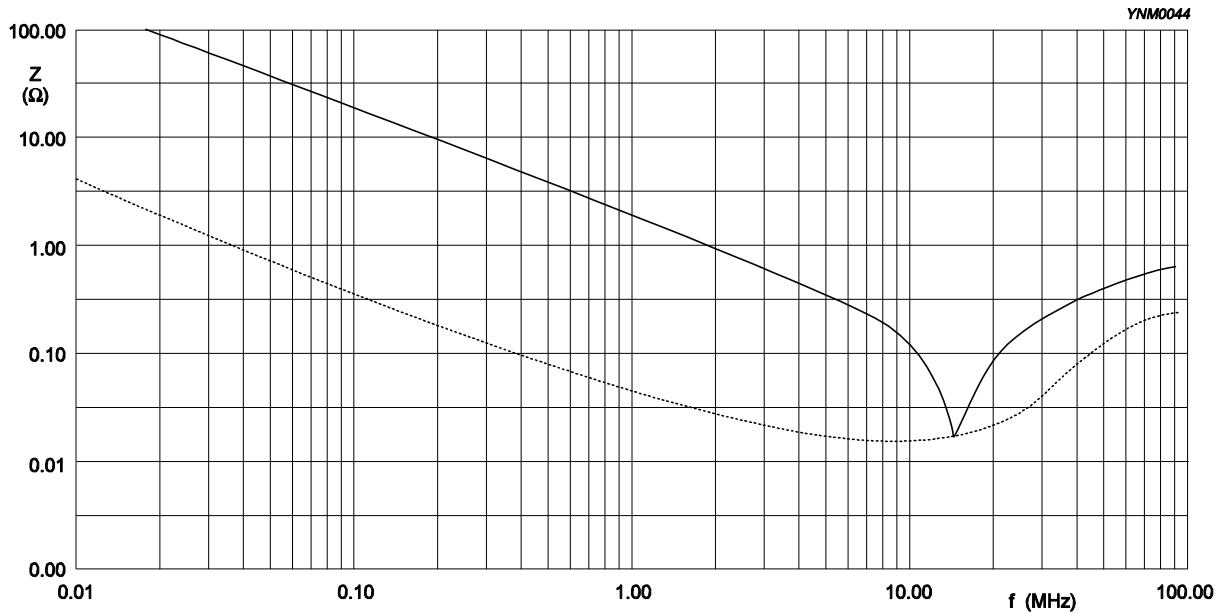

Fig. 9 Impedance ESR vs. frequency characteristics for multilayer chip capacitors

SOLDERING RECOMMENDATION

Table 8

SOLDERING METHOD	SIZE				
	0402	0603	0805	1206	≥ 1210
Reflow	≥ 0.1 μF	≥ 1.0 μF	≥ 2.2 μF	≥ 4.7 μF	Reflow only
Reflow/Wave	< 0.1 μF	< 1.0 μF	< 2.2 μF	< 4.7 μF	---

TESTS AND REQUIREMENTS

Table 9 Test procedures and requirements

TEST	TEST METHOD	PROCEDURE	REQUIREMENTS
Mounting	IEC 60384-21/22	4.3 The capacitors may be mounted on printed-circuit boards or ceramic substrates	No visible damage
Visual Inspection and Dimension Check	4.4	Any applicable method using × 10 magnification	In accordance with specification
Capacitance ⁽¹⁾	4.5.1	Class 2: At 20 °C, 24 hrs after annealing f = 1 KHz for C ≤ 10 μF, rated voltage > 6.3 V, measuring at voltage 1 V _{rms} at 20 °C f = 1 KHz, for C ≤ 10 μF, rated voltage ≤ 6.3 V, measuring at voltage 0.5 V _{rms} at 20 °C f = 120 Hz for C > 10 μF, measuring at voltage 0.5 V _{rms} at 20 °C	Within specified tolerance
Dissipation Factor (D.F.) ⁽¹⁾	4.5.2	Class 2: At 20 °C, 24 hrs after annealing f = 1 KHz for C ≤ 10 μF, rated voltage > 6.3 V, measuring at voltage 1 V _{rms} at 20 °C f = 1 KHz, for C ≤ 10 μF, rated voltage ≤ 6.3 V, measuring at voltage 0.5 V _{rms} at 20 °C f = 120 Hz for C > 10 μF, measuring at voltage 0.5 V _{rms} at 20 °C	In accordance with specification
Insulation Resistance	4.5.3	At U _r (DC) for 1 minute	In accordance with specification

NOTE:

1. For individual product specification, please contact local sales.

TEST	TEST METHOD	PROCEDURE	REQUIREMENTS									
Temperature Characteristic	IEC 60384- 21/22 4.6	Capacitance shall be measured by the steps shown in the following table. The capacitance change should be measured after 5 min at each specified temperature stage.	<General purpose series> Class1: $\Delta C/C: \pm 30\text{ppm}$ Class2: X7R: $\Delta C/C: \pm 15\%$ Y5V: $\Delta C/C: 22\sim-82\%$ <High Capacitance series> Class2: X7R/X5R: $\Delta C/C: \pm 15\%$ Y5V: $\Delta C/C: 22\sim-82\%$									
		<table border="1"> <thead> <tr> <th>Step</th> <th>Temperature(°C)</th> </tr> </thead> <tbody> <tr> <td>a</td> <td>25±2</td> </tr> <tr> <td>b</td> <td>Lower temperature±3°C</td> </tr> <tr> <td>c</td> <td>25±2</td> </tr> <tr> <td>d</td> <td>Upper Temperature±2°C</td> </tr> <tr> <td>e</td> <td>25±2</td> </tr> </tbody> </table> <p>(1) Class I Temperature Coefficient shall be calculated from the formula as below $\text{Temp, Coefficient} = \frac{C2 - C1}{C1 \times \Delta T} \times 10^6 \text{ [ppm/°C]}$ C1: Capacitance at step c C2: Capacitance at 125°C $\Delta T: 100\text{°C}(=125\text{°C}-25\text{°C})$</p> <p>(2) Class II Capacitance Change shall be calculated from the formula as below $\Delta C = \frac{C2 - C1}{C1} \times 100\%$ C1: Capacitance at step c C2: Capacitance at step b or d</p>		Step	Temperature(°C)	a	25±2	b	Lower temperature±3°C	c	25±2	d
Step	Temperature(°C)											
a	25±2											
b	Lower temperature±3°C											
c	25±2											
d	Upper Temperature±2°C											
e	25±2											
Adhesion	4.7	A force applied for 10 seconds to the line joining the terminations and in a plane parallel to the substrate	Force size ≥ 0603: 5N size = 0402: 2.5N size = 0201: 1N									
Bond Strength	4.8	Mounting in accordance with IEC 60384-22 paragraph 4.3 Conditions: bending 1 mm at a rate of 1 mm/s, radius jig 340 mm	No visible damage <General Purpose series> $\Delta C/C$ Class2: X7R: ±10% <High Capacitance series> $\Delta C/C$ Class2: X7R: ±10%									

TEST	TEST METHOD	PROCEDURE	REQUIREMENTS
Resistance to Soldering Heat	4.9	Precondition: 150 +0/-10 °C for 1 hour, then keep for 24 ±1 hours at room temperature	Dissolution of the end face plating shall not exceed 25% of the length of the edge concerned
		Preheating: for size ≤ 1206: 120 °C to 150 °C for 1 minute Preheating: for size > 1206: 100 °C to 120 °C for 1 minute and 170 °C to 200 °C for 1 minute Solder bath temperature: 260 ±5 °C Dipping time: 10 ±0.5 seconds Recovery time: 24 ±2 hours	
			<p><General Purpose series></p> <p>ΔC/C</p> <p>Class2:</p> <p>X7R: ±10%</p> <hr/> <p><High Capacitance series></p> <p>ΔC/C</p> <p>Class2:</p> <p>X7R: ±10%</p> <hr/> <p>D.F. within initial specified value</p> <p>R_{ins} within initial specified value</p>
Solderability	IEC 60384-21/22	4.10 Preheated to a temperature of 80 °C to 140 °C and maintained for 30 seconds to 60 seconds.	The solder should cover over 95% of the critical area of each termination
		<p>Test conditions for lead containing solder alloy</p> <p>Temperature: 235 ±5 °C</p> <p>Dipping time: 2 ±0.2 seconds</p> <p>Depth of immersion: 10 mm</p> <p>Alloy Composition: 60/40 Sn/Pb</p> <p>Number of immersions: 1</p> <p>Test conditions for lead-free containing solder alloy</p> <p>Temperature: 245 ±5 °C</p> <p>Dipping time: 3 ±0.3 seconds</p> <p>Depth of immersion: 10 mm</p> <p>Alloy Composition: SAC305</p> <p>Number of immersions: 1</p>	
Rapid Change of Temperature	4.11	Preconditioning: 150 +0/-10 °C for 1 hour, then keep for 24 ±1 hours at room temperature	No visual damage
			<p><General Purpose series></p> <p>ΔC/C</p> <p>Class2:</p> <p>X7R: ±15%</p> <hr/> <p><High Capacitance series></p> <p>ΔC/C</p> <p>Class2:</p> <p>X7R: ±15%</p> <hr/> <p>D.F. meet initial specified value</p> <p>R_{ins} meet initial specified value</p>

TEST	TEST METHOD	PROCEDURE	REQUIREMENTS
Damp Heat with U_r Load	IEC 60384-21/22 4.13	<ol style="list-style-type: none"> Preconditioning, class 2 only: 150 +0/-10 °C /1 hour, then keep for 24 ±1 hour at room temp Initial measure: Spec: refer to initial spec C, D, IR Damp heat test: 500 ±12 hours at 40 ±2 °C; 90 to 95% R.H. 1.0 U_r applied Recovery: Class 2: 24 ±2 hours Final measure: C, D, IR <p>P.S. If the capacitance value is less than the minimum value permitted, then after the other measurements have been made the capacitor shall be preconditioned according to "IEC 60384 4.1" and then the requirement shall be met.</p>	<p>No visual damage after recovery</p> <hr/> <p><General Purpose series> $\Delta C/C$ Class2: X7R: ±15% D.F. Class2: X7R: ≤ 16V: ≤ 7% ≥ 25V: ≤ 5% R_{ins} Class2: X7R: ≥ 500 MΩ or $R_{ins} \times C_r \geq 25s$ whichever is less</p> <p><High Capacitance series> $\Delta C/C$ Class2: X7R: ±20% D.F. Class2: X7R: 2 × initial value max R_{ins} Class2: X7R: 500 MΩ or $R_{ins} \times C_r \geq 25s$ whichever is less</p>

TEST	TEST METHOD	PROCEDURE	REQUIREMENTS
Endurance	IEC 60384- 21/22 4.14	<p>1. Preconditioning, class 2 only: 150 +0/-10 °C /1 hour, then keep for 24 ±1 hour at room temp</p> <p>2. Initial measure: Spec: refer to initial spec C, D, IR</p> <p>3. Endurance test: Temperature: X7R: 125 °C Specified stress voltage applied for 1,000 hours: Applied 2.0 × U_r for general products Applied 1.5(1.0) × U_r for high cap. products</p> <p>4. Recovery time: 24 ±2 hours</p> <p>5. Final measure: C, D, IR</p> <p>P.S. If the capacitance value is less than the minimum value permitted, then after the other measurements have been made the capacitor shall be preconditioned according to "IEC 60384 4.1" and then the requirement shall be met.</p>	<p>No visual damage</p> <hr/> <p><General Purpose series> $\Delta C/C$ Class2: X7R: ±15% D.F. Class2: X7R: $\leq 16V: \leq 7\%$ $\geq 25V: \leq 5\%$ R_{ins} Class2: X7R: $\geq 1,000 M\Omega$ or $R_{ins} \times C_r \geq 50s$ whichever is less</p> <p><High Capacitance series> $\Delta C/C$ Class 2: X7R: ±20% D.F. Class 2: X7R: 2 × initial value max R_{ins} Class 2: X7R: $1,000 M\Omega$ or $R_{ins} \times C_r \geq 50(10)s$ whichever is less</p>
Voltage Proof	IEC 60384- 4.6 I	<p>Specified stress voltage applied for 1~5 seconds $U_r \leq 100 V$: series applied 2.5 U_r Charge/Discharge current is less than 50 mA</p>	No breakdown or flashover

REVISION HISTORY

REVISION	DATE	CHANGE NOTIFICATION	DESCRIPTION
Version 10	Jul. 08, 2014	-	- Dimension updated
Version 9	Aug. 19, 2013	-	- Dimension updated
Version 8	Oct 13, 2011	-	- Dimension updated
Version 7	Jan 13, 2011	-	- Dimension updated
Version 6	Oct 13, 2010	-	- Rated voltage of 0201 extend to 50 V - Capacitance range of 0201 X7R 6.3V to 16V extend to 100 pF - Capacitance range of 0805 X7R 10V extend to 10 μF - Capacitance range of 0805 X7R 50V extend to 1 μF - Capacitance range of 1210 X7R 10V extend to 22 μF - Figures of impedance ESR updated
Version 5	Jul 27, 2010	-	- Dimension on 0603 and 1206 case size updated
Version 4	Apr 21, 2010	-	- The statement of "Halogen Free" on the cover added - Dimension updated
Version 3	Oct 26, 2009	-	- Capacitance range of 0402 X7R 25 V extend to 100 nF
Version 2	May 11, 2009	-	- Product range updated
Version 1	Apr 24, 2009	-	- Ordering code updated
Version 0	Apr 15, 2009	-	- New datasheet for general purpose and high capacitance X7R series with RoHS compliant - Replace the "6.3V to 50V" part of pdf files: X7R_10V_9, X7R_16V-to-100V_9, X7R_16-to-500V_9, UP-X5R_X7R_HighCaps_6.3-to-25V_11, UY-X5R_X7R_HighCaps_6.3-to-25V_11 - Combine 0201 from pdf files: UP-NP0X5RX7RY5V_0201_6.3-to-50V_2 and UY-NPOX5RX7RY5V_0201_6.3-to-50V_2 - Define global part number - Description of "Halogen Free compliant" added - Test method and procedure updated

Mouser Electronics

Authorized Distributor

Click to View Pricing, Inventory, Delivery & Lifecycle Information:

Yageo:

[CC0805JKX7R9BB474](#) [CC0603KRX7R8BB562](#) [CC0805JRX7R9BB202](#) [CC0603JRX7R7BB102](#)
[CC0603JRX7R6BB105](#) [CC0603KRX7R9BB431](#) [CC0603KRX7R9BB474](#) [CC0603KRX7R9BB154](#)
[CC0805KKX7R9BB274](#) [CC0805KKX7R9BB684](#) [CC0603JRX7R7BB103](#) [CC0603KRX7R9BB361](#)
[CC0603JRX7R8BB123](#) [CC0603JRX7R9BB224](#) [CC0603JRX7R9BB151](#) [CC1206JRX7R8BB104](#)
[CC1812JKX7R9BB154](#) [CC0402JRX7R9BB473](#) [CC0805KRX7R8BB123](#) [CC0402KRX7R5BB224](#)
[CC0402KRX7R7BB471](#) [CC0603KRX7R7BB394](#) [CC1206JKX7R9BB184](#) [CC0805JRX7R9BB391](#)
[CC0805KRX7R5BB104](#) [CC0603JRX7R7BB154](#) [CC0603KRX7R5BB224](#) [CC0402KRX7R8BB224](#)
[CC0603MRX7R9BB223](#) [CC1206KKX7R7BB824](#) [CC0805KKX7R7BB106](#) [CC2220JKX7R9BB105](#)
[CC0805KRX7R7BB103](#) [CC0805JKX7R9BB105](#) [CC0805KKX7R6BB334](#) [CC0603KRX7R7BB225](#)
[CC0402KRX7R9BB123](#) [CC0805KRX7R6BB104](#) [CC0201KRX7R7BB101](#) [CC0402KRX7R8BB393](#)
[CC1206JKX7R8BB225](#) [CC0402KRX7R7BB331](#) [CC1206JRX7R9BB393](#) [CC0402JRX7R8BB102](#)
[CC0805JRX7R8BB221](#) [CC0603KRX7R6BB274](#) [CC0402JRX7R7BB101](#) [CC1206KFX7R7BB106](#)
[CC0201JRX7R8BB681](#) [CC0402MRX7R8BB103](#) [CC0603KRX7R8BB124](#) [CC0201KRX7R5BB104](#)
[CC0805KFX7R9BB105](#) [CC1206KFX7R9BB105](#) [CC0402KRX7R5BB103](#) [CC0805JKX7R7BB394](#)
[CC0805KRX7R6BB102](#) [CC0805KFX7R9BB224](#) [CC0603MRX7R9BB151](#) [CC1206JRX7R9BB331](#)
[CC1206JRX7R9BB183](#) [CC0603KRX7R7BB331](#) [CC0603KRX7R9BB501](#) [CC0402KRX7R6BB472](#)
[CC0603KPX7R8BB224](#) [CC0603JPX7R9BB473](#) [CC0603JPX7R9BB153](#) [CC0201JRX7R8BB471](#)
[CC0805JRX7R8BB224](#) [CC0603MRX7R7BB473](#) [CC0603KRX7R7BB562](#) [CC0402KPX7R6BB224](#)
[CC1812JKX7R9BB274](#) [CC0603MRX7R9BB682](#) [CC1206JRX7R9BB561](#) [CC1812JKX7R9BB124](#)
[CC0805JRX7R8BB333](#) [CC0603MRX7R8BB333](#) [CC1206JRX7R7BB274](#) [CC0603JRX7R8BB334](#)
[CC0201KRX7R8BB272](#) [CC0603JRX7R7BB184](#) [CC1206JRX7R9BB122](#) [CC1206JRX7R9BB681](#)
[CC1206JKX7R8BB274](#) [CC0805JRX7R9BB203](#) [CC0402KPX7R8BB333](#) [CC1206KPX7R9BB152](#)
[CC0402JRX7R7BB683](#)