

FEATURES

IQ demodulator with integrated fractional-N PLL
LO frequency range: 750 MHz to 1150 MHz
Input P1dB: 12.5 dBm
Input IP3: 25 dBm
Noise figure (DSB): 14.3 dB
Voltage conversion gain: 5.1 dB
Quadrature demodulation accuracy
 Phase accuracy: 0.3°
 Amplitude accuracy: 0.05 dB
Baseband demodulation: 275 MHz, 3 dB bandwidth
SPI serial interface for PLL programming
40-lead, 6 mm × 6 mm LFCSP

APPLICATIONS

QAM/QPSK RF/IF demodulators
Cellular W-CDMA/CDMA/CDMA2000
Microwave point-to-(multi)point radios
Broadband wireless and WiMAX

GENERAL DESCRIPTION

The ADRF6801 is a high dynamic range IQ demodulator with integrated PLL and VCO. The fractional-N PLL/synthesizer generates a frequency in the range of 3.0 GHz to 4.6 GHz. A divide-by-4 quadrature divider divides the output frequency of the VCO down to the required local oscillator (LO) frequency to drive the mixers in quadrature. Additionally, an output buffer can be enabled that generates an $f_{VCO}/2$ signal for external use.

The PLL reference input is supported from 10 MHz to 160 MHz. The phase detector output controls a charge pump whose output is integrated in an off-chip loop filter. The loop filter output is then applied to an integrated VCO.

The IQ demodulator mixes the differential RF input with the complex LO derived from the quadrature divider. The differential I and Q output paths have excellent quadrature accuracy and can handle baseband signaling or complex IF up to 120 MHz.

The ADRF6801 is fabricated using an advanced silicon-germanium BiCMOS process. It is available in a 40-lead, exposed-paddle, RoHS-compliant, 6 mm × 6 mm LFCSP package. Performance is specified over the -40°C to $+85^{\circ}\text{C}$ temperature range.

FUNCTIONAL BLOCK DIAGRAM

Figure 1.

Rev. A

[Document Feedback](#)

Information furnished by Analog Devices is believed to be accurate and reliable. However, no responsibility is assumed by Analog Devices for its use, nor for any infringements of patents or other rights of third parties that may result from its use. Specifications subject to change without notice. No license is granted by implication or otherwise under any patent or patent rights of Analog Devices. Trademarks and registered trademarks are the property of their respective owners.

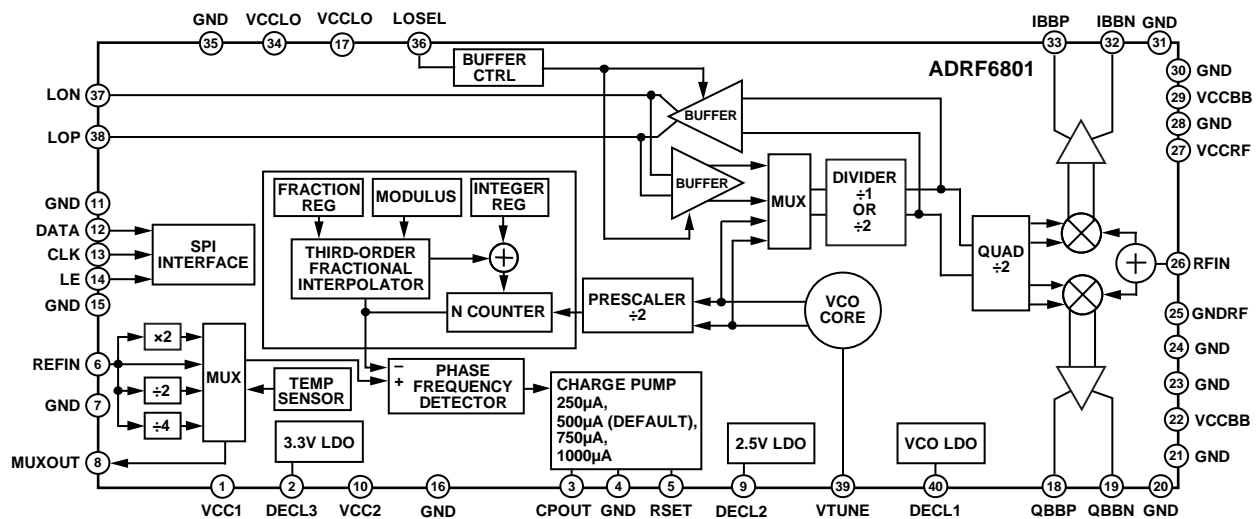
One Technology Way, P.O. Box 9106, Norwood, MA 02062-9106, U.S.A.
 Tel: 781.329.4700 ©2011–2018 Analog Devices, Inc. All rights reserved.
[Technical Support](#) www.analog.com

TABLE OF CONTENTS

Features	1	Register Structure	14
Applications	1	Applications Information	21
General Description	1	Basic Connections	21
Functional Block Diagram	1	Supply Connections	21
Revision History	2	Synthesizer Connections	21
Specifications	3	I/Q Output Connections	22
Timing Characteristics	5	RF Input Connections	22
Absolute Maximum Ratings	6	Charge Pump/VTUNE Connections	22
Pin Configuration and Function Descriptions	7	LO Select Interface	22
Typical Performance Characteristics	9	External LO Interface	22
Synthesizer/PLL	12	Setting the Frequency of the PLL	22
Complementary Cumulative Distribution Functions (CCDF)	13	Register Programming	22
Circuit Description	14	EVM Measurements	23
LO Quadrature Drive	14	Evaluation Board Layout and Thermal Grounding	24
V-to-I Converter	14	ADRF6801 Software	28
Mixers	14	Characterization Setups	30
Emitter Follower Buffers	14	Outline Dimensions	34
Bias Circuitry	14	Ordering Guide	34

REVISION HISTORY

6/2018—Rev. 0 to Rev. A

Change to Register Structure Section	14
Changes to Register Programming Section	22

1/2011—Revision 0: Initial Version

SPECIFICATIONS

$V_S = 5\text{ V}$; ambient temperature (T_A) = 25°C; $f_{REF} = 26\text{ MHz}$, $f_{LO} = 900\text{ MHz}$, $f_{BB} = 4.5\text{ MHz}$, $R_{LOAD} = 450\ \Omega$ differential, all register and PLL settings use the recommended values shown in the Register Structure section, unless otherwise noted.

Table 1.

Parameter	Test Conditions/Comments	Min	Typ	Max	Unit
RF INPUT AT 900 MHz	RFIN pins				
Internal LO Frequency Range	With VCO amplitude = 63 (R6 [DB15 to DB10])	750		1125	MHz
	With VCO amplitude = 24 (R6 [DB15 to DB10])	750		1150	MHz
Input Return Loss	Measured at 900 MHz		<−20		dB
Input P1dB			12.5		dBm
Second-Order Input Intercept (IIP2)	−5 dBm each tone		>65		dBm
Third-Order Input Intercept (IIP3)	−5 dBm each tone		25		dBm
Noise Figure	Double sideband from RF to either I or Q output		14.3		dB
	With a −10 dBm interferer 5 MHz away		18.9		dB
LO-to-RF Leakage	At 1×LO frequency, 50 Ω termination at the RF port		−75		dBm
I/Q BASEBAND OUTPUTS	IBBP, IBBN, QBBP, QBPN pins				
Voltage Conversion Gain	450 Ω differential load across IBBP, IBBN (or QBBP, QBPN)		5.1		dB
Demodulation Bandwidth	1 V p-p signal 3 dB bandwidth		275		MHz
Quadrature Phase Error			0.3		Degrees
I/Q Amplitude Imbalance			0.05		dB
Output DC Offset (Differential)			±5		mV
Output Common-Mode Voltage			$V_{POS} - 2.4$		V
Gain Flatness	Any 5 MHz (<100 MHz)		0.2		dB p-p
Maximum Output Swing	Differential 450 Ω load		4		V p-p
	Differential 200 Ω load		2.4		V p-p
Maximum Output Current	Each pin		12		mA p-p
LO INPUT/OUTPUT	LOP, LON				
Output Level	Into a differential 50 Ω load, LO buffer enabled (LO frequency = 900 MHz, output frequency = 1800 MHz)		−2.5		dBm
Input Level	Externally applied 2×LO, PLL disabled		0		dBm
Input Impedance	Externally applied 2×LO, PLL disabled		50		Ω
VCO Operating Frequency	With VCO amplitude = 63 (R6 [DB15 to DB10])	3000		4500	MHz
	With VCO amplitude = 24 (R6 [DB15 to DB10])	3000		4600	MHz
SYNTHESIZER SPECIFICATIONS	All synthesizer specifications measured with recommended settings provided in Figure 33 through Figure 39				
Channel Spacing	$f_{PFD} = 26\text{ MHz}$; modulus = 2047		25		kHz
PLL Bandwidth	Can be adjusted with off-chip loop filter component values and R_{SET}		130		kHz
SPURS	$f_{LO} = 900\text{ MHz}$, $f_{REF} = 26\text{ MHz}$, $f_{PFD} = 26\text{ MHz}$, measured at BB outputs with $f_{BB} = 50\text{ MHz}$				
Reference Spurs	$f_{REF} = 26\text{ MHz}$, $f_{PFD} = 26\text{ MHz}$		−91.6		dBc
	$f_{PFD}/2$		−107.8		dBc
	$f_{PFD} \times 2$		−89.1		dBc
	$f_{PFD} \times 3$		−94.2		dBc

Parameter	Test Conditions/Comments	Min	Typ	Max	Unit
PHASE NOISE (USING 130 kHz LOOP FILTER)	$f_{LO} = 900$ MHz, $f_{REF} = 26$ MHz, $f_{PFD} = 26$ MHz, measured at BB outputs with $f_{BB} = 50$ MHz				
	1 kHz offset		-99.5		dBc/Hz
	10 kHz offset		-107.8		dBc/Hz
	100 kHz offset		-106.6		dBc/Hz
	500 kHz offset		-126.7		dBc/Hz
	1 MHz offset		-131.7		dBc/Hz
	5 MHz offset		-143.5		dBc/Hz
	10 MHz offset		-150.5		dBc/Hz
Integrated Phase Noise	1 kHz to 10 MHz integration bandwidth		0.16		°rms
PHASE NOISE (USING 2.5 kHz LOOP FILTER)	$f_{LO} = 900$ MHz, $f_{REF} = 26$ MHz, $f_{PFD} = 26$ MHz, measured at BB outputs with $f_{BB} = 50$ MHz				
	1 kHz offset		-71.3		dBc/Hz
	10 kHz offset		-88.3		dBc/Hz
	100 kHz offset		-114.1		dBc/Hz
	500 kHz offset		-129.5		dBc/Hz
	1 MHz offset		-138.6		dBc/Hz
	5 MHz offset		-150.2		dBc/Hz
	10 MHz offset		-150.3		dBc/Hz
PLL FIGURE OF MERIT (FOM)	Measured with $f_{REF} = 26$ MHz, $f_{PFD} = 26$ MHz		-215.4		dBc/Hz/Hz
	Measured with $f_{REF} = 104$ MHz, $f_{PFD} = 26$ MHz		-220.9		dBc/Hz/Hz
Phase Detector Frequency		20	26	40	MHz
REFERENCE CHARACTERISTICS	REFIN, MUXOUT pins				
REFIN Input Frequency	Usable range	10		160	MHz
REFIN Input Capacitance			4		pF
MUXOUT Output Level	V_{OL} (lock detect output selected)			0.25	V
	V_{OH} (lock detect output selected)	2.7			V
REFOUT Duty Cycle			50		%
CHARGE PUMP					
Pump Current			500		µA
Output Compliance Range		1		2.8	V
LOGIC INPUTS	CLK, DATA, LE pins				
Input High Voltage, V_{INH}		1.4		3.3	V
Input Low Voltage, V_{INL}		0		0.7	V
Input Current, I_{INH}/I_{INL}			0.1		µA
Input Capacitance, C_{IN}			5		pF
POWER SUPPLIES	VCC1, VCC2, VCCLO, VCCBB, VCCRF pins				
Voltage Range (5 V)		4.75	5	5.25	V
Supply Current (5 V)	Normal Rx mode, internal LO		262		mA
	Rx mode, internal LO with LO buffer enabled		288		mA
	Rx mode, using external LO input (internal VCO, PLL shut down)		157		mA
Supply Current (5 V)	Power-down mode		20		mA

TIMING CHARACTERISTICS

$V_s = 5\text{ V}$, unless otherwise noted.

Table 2.

Parameter	Limit at T_{MIN} to T_{MAX} (B Version)	Unit	Test Conditions/Comments
t_1	20	ns min	LE setup time
t_2	10	ns min	DATA to CLK setup time
t_3	10	ns min	DATA to CLK hold time
t_4	25	ns min	CLK high duration
t_5	25	ns min	CLK low duration
t_6	10	ns min	CLK to LE setup time
t_7	20	ns min	LE pulse width

Timing Diagram

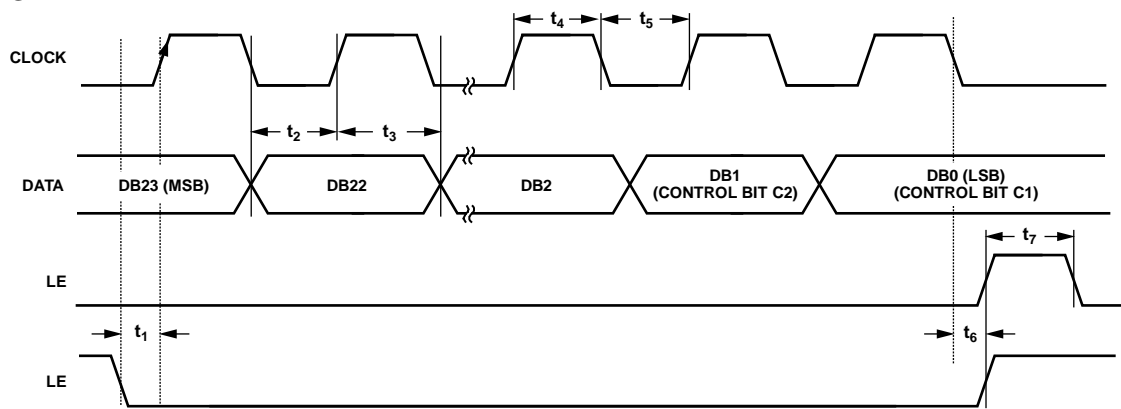

Figure 2. Timing Diagram

09576-002

ABSOLUTE MAXIMUM RATINGS

Table 3.

Parameter	Rating
Supply Voltage, VCC1, VCC2, VCCLO, VCCBB, and VCCRF (V _{SI})	−0.5 V to +5.5 V
Digital I/O, CLK, DATA, and LE RFIN	−0.3 V to +3.6 V 16 dBm
θ _{JA} (Exposed Paddle Soldered Down)	30°C/W
Maximum Junction Temperature	150°C
Operating Temperature Range	−40°C to +85°C
Storage Temperature Range	−65°C to +150°C

Stresses at or above those listed under Absolute Maximum Ratings may cause permanent damage to the product. This is a stress rating only; functional operation of the product at these or any other conditions above those indicated in the operational section of this specification is not implied. Operation beyond the maximum operating conditions for extended periods may affect product reliability.

ESD CAUTION



ESD (electrostatic discharge) sensitive device. Charged devices and circuit boards can discharge without detection. Although this product features patented or proprietary protection circuitry, damage may occur on devices subjected to high energy ESD. Therefore, proper ESD precautions should be taken to avoid performance degradation or loss of functionality.

PIN CONFIGURATION AND FUNCTION DESCRIPTIONS

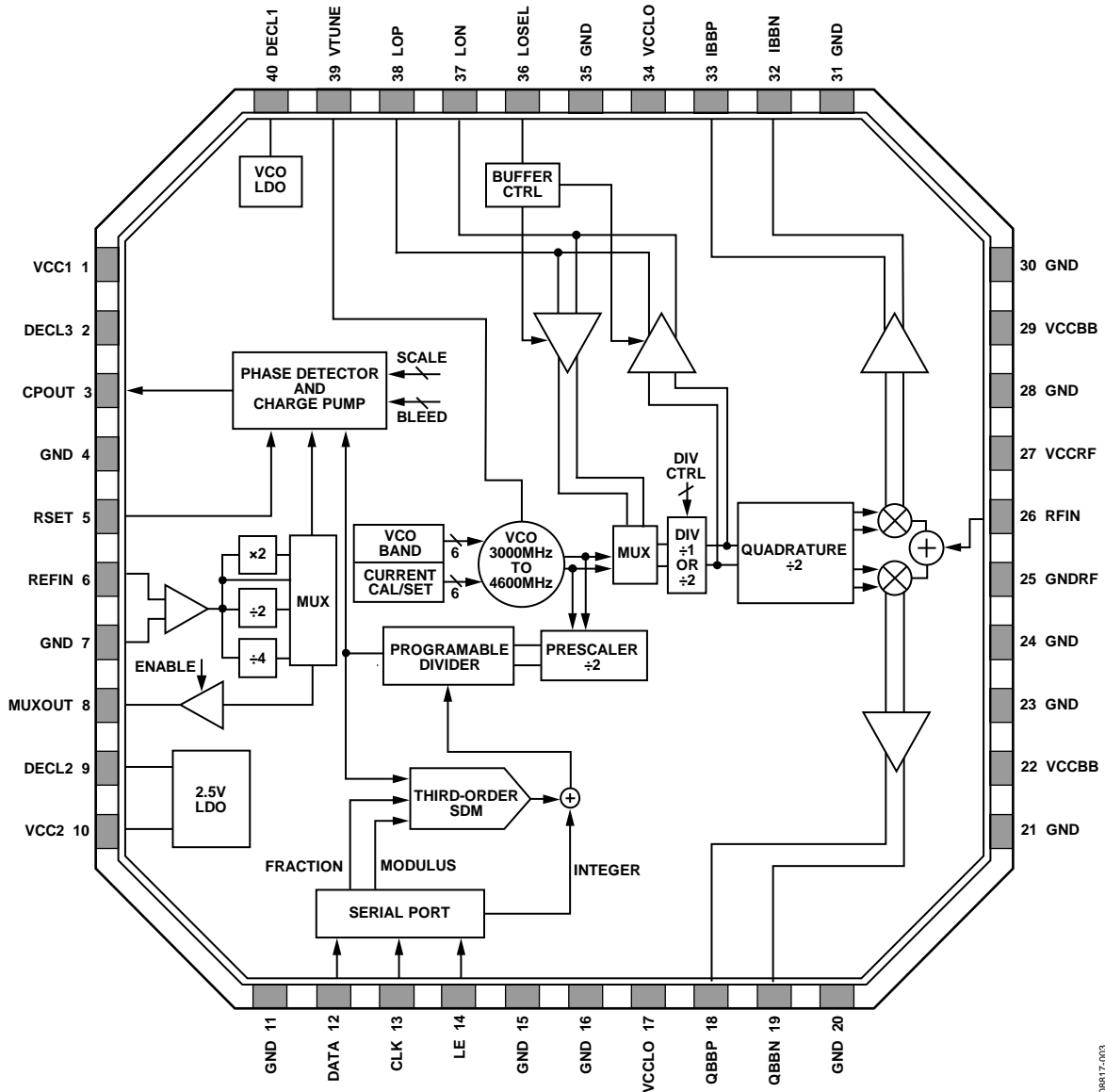

Figure 3. Pin Configuration

08817-003

Table 4. Pin Function Descriptions

Pin No.	Mnemonic	Description
1	VCC1	The 5 V Power Supply Pin for VCO and PLL (VCC1).
2	DECL3	Decoupling Node for the 3.3 V LDO. Connect a 0.1 μ F capacitor between this pin and ground.
3	CPOUT	Charge Pump Output Pin. Connect this pin to VTUNE through the loop filter.
4, 7, 11, 15, 16, 20, 21, 23, 24, 28, 30, 31, 35	GND	Connect these pins to a low impedance ground plane.

Pin No.	Mnemonic	Description
5	RSET	Charge Pump Current. The nominal charge pump current can be set to 250 μ A, 500 μ A, 750 μ A, or 1 mA using DB10 and DB11 of Register 4 and by setting DB18 to 0 (internal reference current). In this mode, no external R _{SET} is required. If DB18 is set to 1, the four nominal charge pump currents (I _{NOMINAL}) can be externally tweaked according to the following equation where the resulting value is in units of ohms. $R_{SET} = \left[\frac{217.4 \times I_{CP}}{I_{NOMINAL}} \right] - 37.8$
6	REFIN	Reference Input. Nominal input level is 1 V p-p. Input range is 10 MHz to 160 MHz.
8	MUXOUT	Multiplexer Output. This output can be programmed to provide the reference output signal or the lock detect signal. The output is selected by programming the appropriate register.
9	DECL2	Decoupling Node for 2.5 V LDO. Connect a 0.1 μ F capacitor between this pin and ground.
10	VCC2	The 5 V power supply pin for the 2.5 V LDO.
12	DATA	Serial Data Input. The serial data is loaded MSB first with the three LSBs being the control bits.
13	CLK	Serial Clock Input. This serial clock is used to clock in the serial data to the registers. The data is latched into the 24-bit shift register on the CLK rising edge. Maximum clock frequency is 20 MHz.
14	LE	Load Enable. When the LE input pin goes high, the data stored in the shift registers is loaded into one of the six registers, the relevant latch being selected by the first three control bits of the 24-bit word.
17, 34	VCCLO	The 5 V Power Supply for the LO Path Blocks.
18, 19	QBBP, QBBN	Demodulator Q-Channel Differential Baseband Outputs; Differential Output Impedance of 24 Ω .
22, 29	VCCBB	The 5 V Power Supply for the Baseband Output Section of the Demodulator Blocks.
25	GNDRF	Ground Return for RF Input Balun.
26	RFIN	Single-Ended, Ground Referenced 50 Ω , RF Input.
27	VCCRF	The 5 V Power Supply for the RF Input Section of the Demodulator Blocks.
32, 33	IBBN, IBBP	Demodulator I-Channel Differential Baseband Outputs; Differential Output Impedance of 24 Ω .
36	LOSEL	LO Select. Connect this pin to ground for the simplest operation and to completely control the LO path and input/output direction from the register SPI programming. For additional control without register reprogramming, this input pin can determine whether the LOP and LON pins operate as inputs or outputs. LOP and LON become inputs if the LOSEL pin is set low, the LDRV bit of Register 5 is set low, and the LXL bit of Register 5 is set high. The externally applied LO drive must be at 2 \times LO frequency (and the LDIV bit of Register 5 (DB5) set low). LON and LOP become outputs when LOSEL is high or if the LDRV bit of Register 5 (DB3) is set high and the LXL bit of Register 5 (DB4) is set low. The output frequency is 2 \times LO frequency (and the LDIV bit of Register 5 (DB5) must be set high). This pin should not be left floating.
37, 38	LON, LOP	Local Oscillator Input/Output. When these pins are used as output pins, a differential frequency divided version of the internal VCO is available on these pins. When the internal LO generation is disabled, an external M \times LO frequency signal can be applied to these pins (where M corresponds to the LO path divider setting). (Differential Input/Output Impedance of 50 Ω)
39	VTUNE	VCO Control Voltage Input. This pin is driven by the output of the loop filter. The nominal input voltage range on this pin is 1.0 V to 2.8 V.
40	DECL1	Connect a 10 μ F capacitor between this pin and ground as close to the device as possible because this pin serves as the VCO supply and loop filter reference.
	EP	Exposed Paddle. The exposed paddle should be soldered to a low impedance ground plane.

TYPICAL PERFORMANCE CHARACTERISTICS

$V_S = 5\text{ V}$, $T_A = 25^\circ\text{C}$, unless otherwise noted. LO = 750 MHz to 1150 MHz.

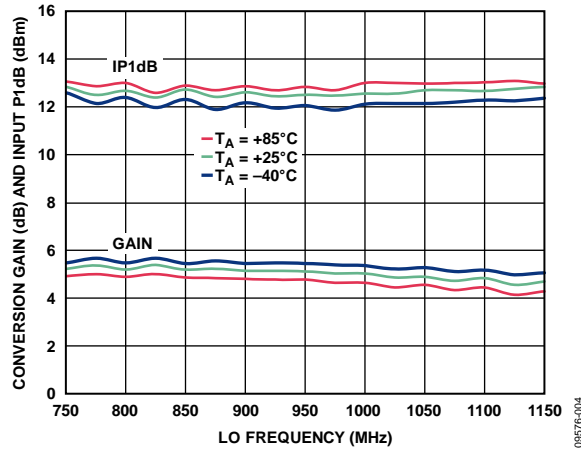

Figure 4. Conversion Gain and Input P1dB vs. LO Frequency

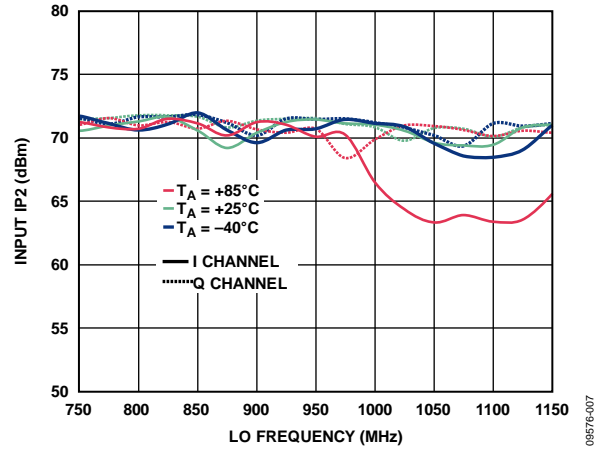

Figure 7. Input IP2 vs. LO Frequency

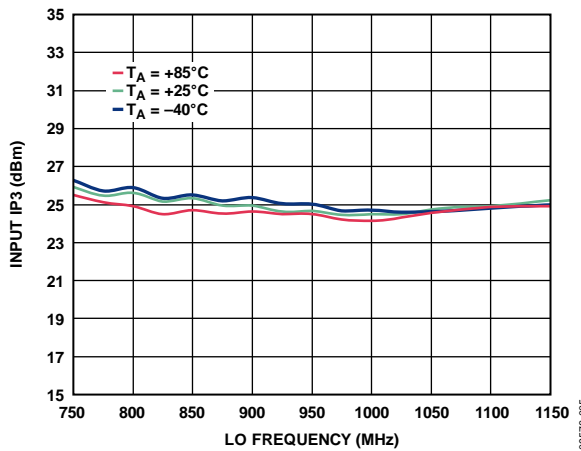

Figure 5. Input IP3 vs. LO Frequency

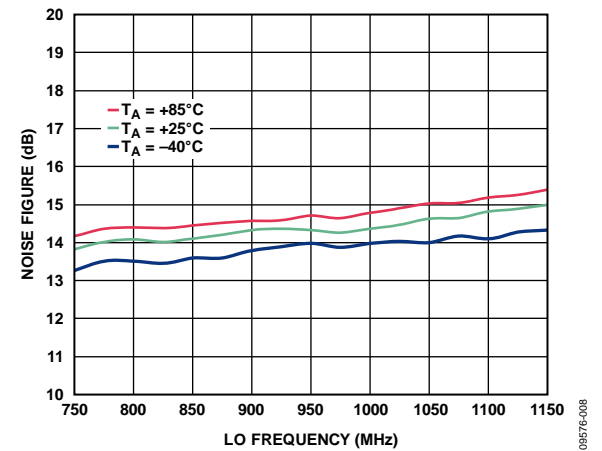

Figure 8. Noise Figure vs. LO Frequency

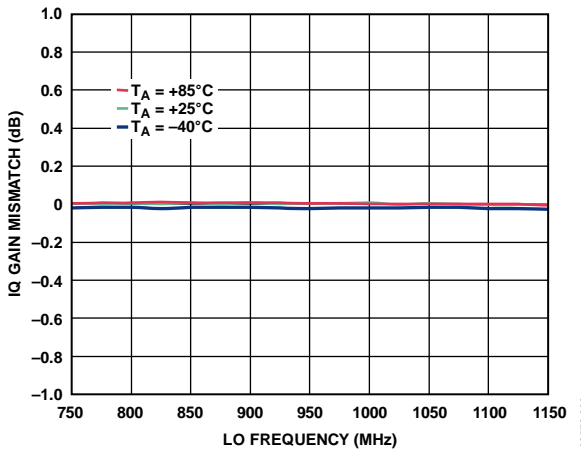

Figure 6. IQ Gain Mismatch vs. LO Frequency

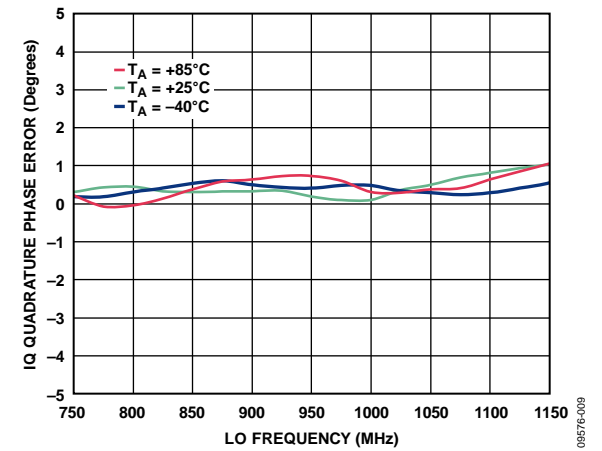

Figure 9. IQ Quadrature Phase Error vs. LO Frequency

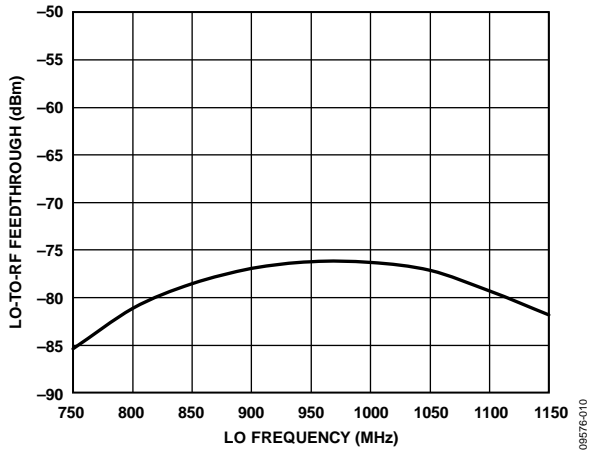

Figure 10. LO-to-RF Feedthrough vs. LO Frequency, LO Output Turned Off

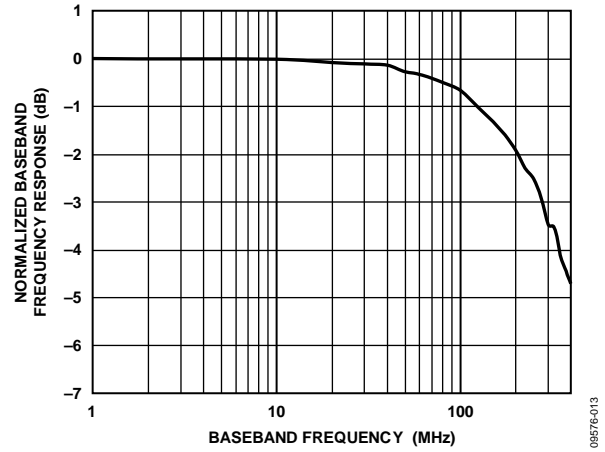

Figure 13. Normalized Baseband Frequency Response vs. Baseband Frequency

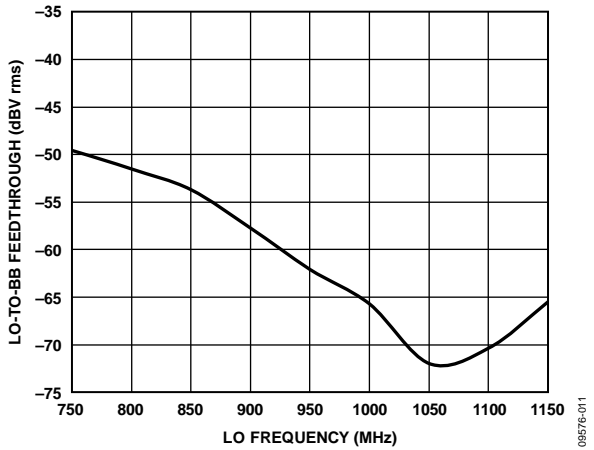

Figure 11. LO-to-BB Feedthrough vs. LO Frequency, LO Output Turned Off

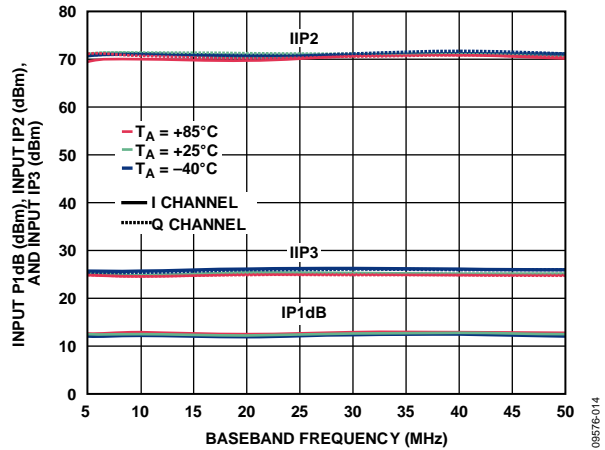

Figure 14. Input P1dB, Input IP2, and Input IP3 vs. Baseband Frequency

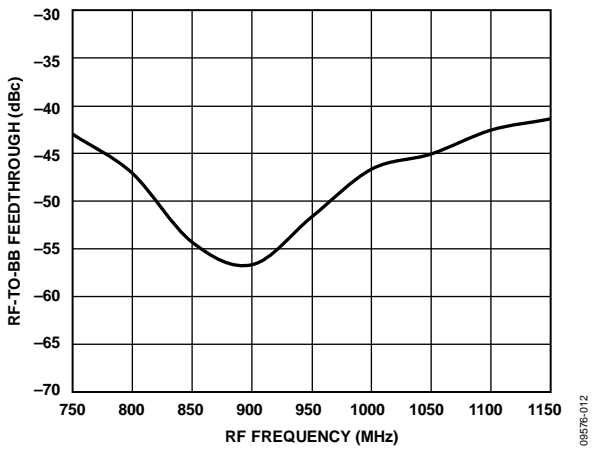

Figure 12. RF-to-BB Feedthrough vs. RF Frequency

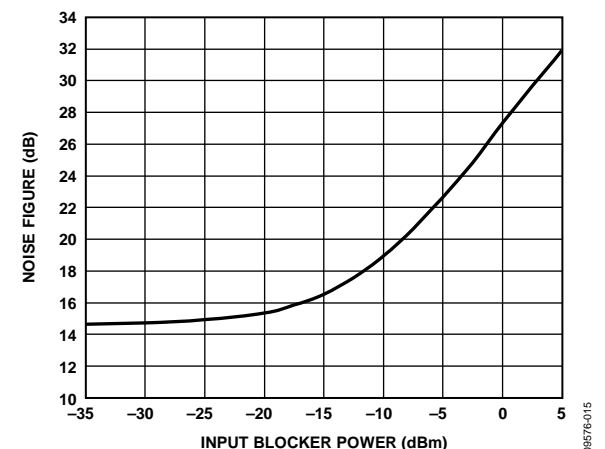

Figure 15. Noise Figure vs. Input Blocker Level, $f_{LO} = 900$ MHz (RF Blocker 5 MHz Offset)

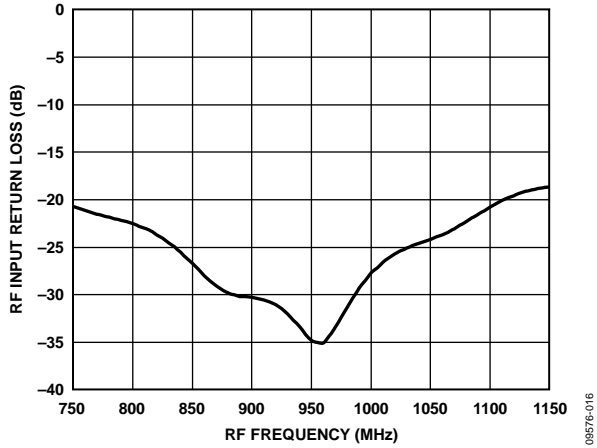

Figure 16. RF Input Return Loss vs. RF Frequency

09576-016

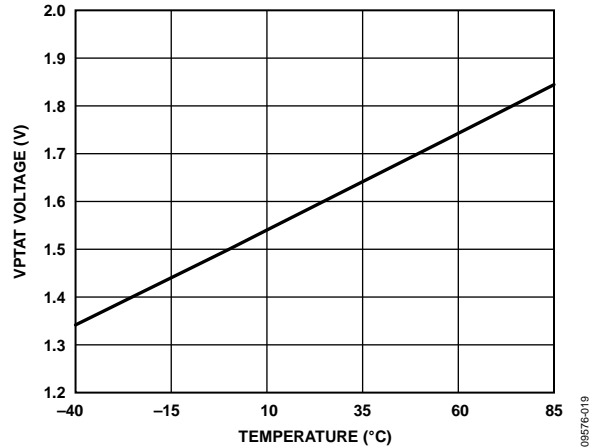

Figure 19. VPTAT vs. Temperature

09576-019

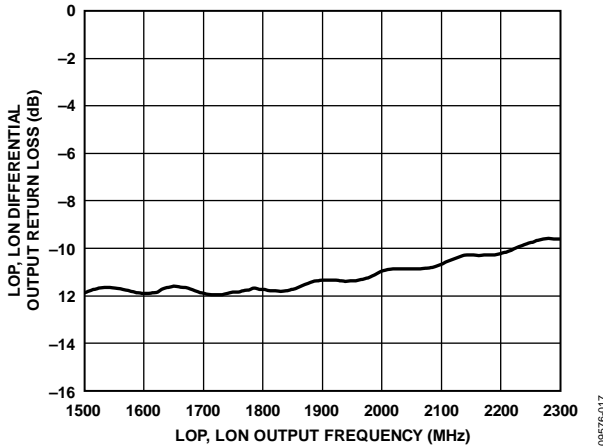

Figure 17. LO Output Return Loss vs. LO Output Frequency, LO Output Enabled (1500 MHz to 2300 MHz), Measured through TC1-1-13 Balun

09576-017

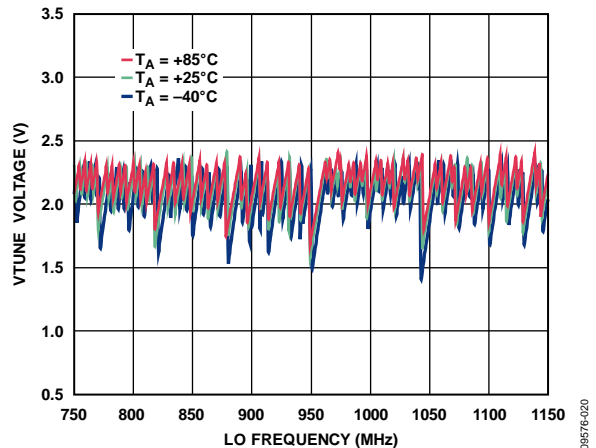

Figure 20. VTUNE vs. LO Frequency

09576-020

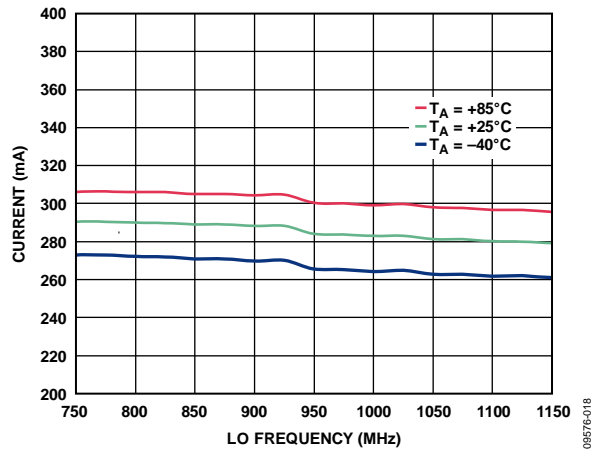

Figure 18. 5V Supply Currents vs. LO Frequency, LO Output Enabled

09576-018

SYNTHESIZER/PLL

$V_S = 5\text{ V}$. See the Register Structure section for recommended settings used. External loop filter bandwidths of $\sim 130\text{ kHz}$ and 2.5 kHz used (see plots within this section for annotations), $f_{REF} = f_{PFD} = 26\text{ MHz}$, measured at BB output, $f_{BB} = 50\text{ MHz}$, unless otherwise noted.

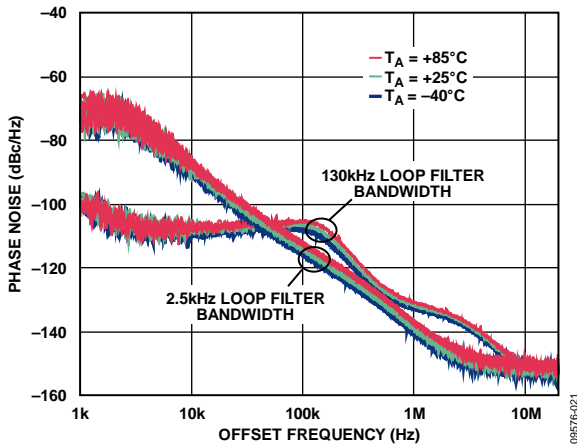

Figure 21. Phase Noise vs. Offset Frequency, $f_{LO} = 900\text{ MHz}$, Shown for Loop Filter Bandwidths of 2.5 kHz and 130 kHz

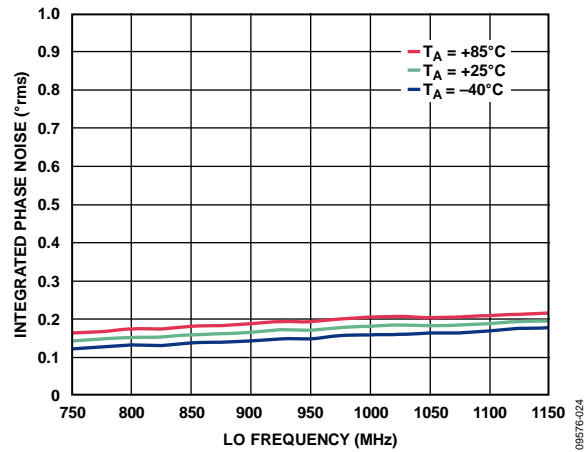

Figure 24. Integrated Phase Noise vs. LO Frequency (Spurs Omitted), Using Loop Filter Bandwidth of 130 kHz

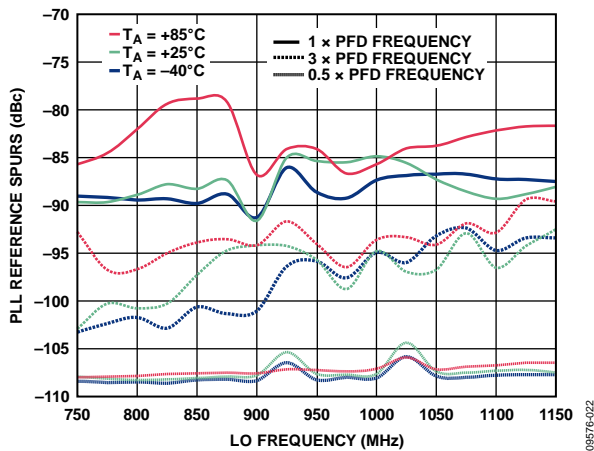

Figure 22. PLL Reference Spurs vs. LO Frequency, Using Loop Filter Bandwidth of 130 kHz

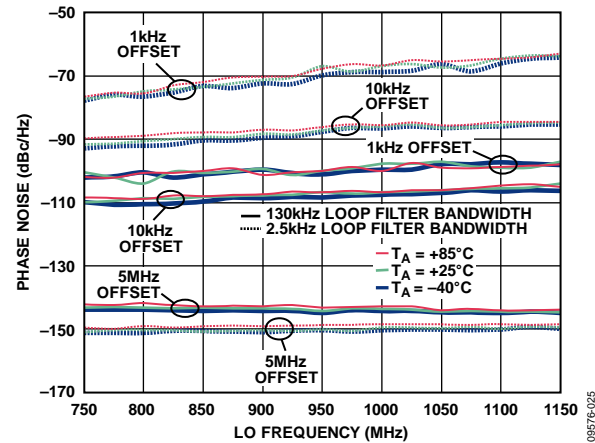

Figure 25. Phase Noise vs. LO Frequency (1 kHz , 10 kHz , and 5 MHz Offsets), Shown for Loop Filter Bandwidths of 2.5 kHz and 130 kHz

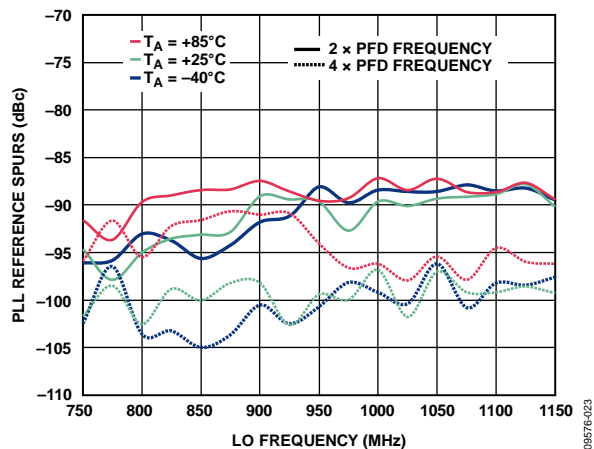

Figure 23. PLL Reference Spurs vs. LO Frequency, Using Loop Filter Bandwidth of 130 kHz

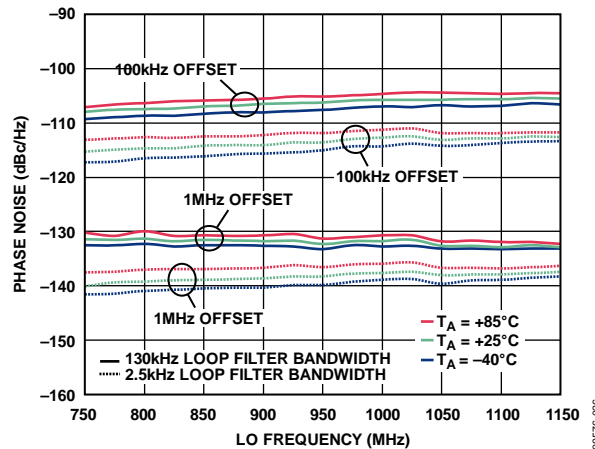

Figure 26. Phase Noise vs. LO Frequency (100 kHz and 1 MHz Offsets), Shown for Loop Filter Bandwidths of 2.5 kHz and 130 kHz

COMPLEMENTARY CUMULATIVE DISTRIBUTION FUNCTIONS (CCDF)

$V_S = 5\text{ V}$, $f_{LO} = 900\text{ MHz}$, $f_{BB} = 4.5\text{ MHz}$.

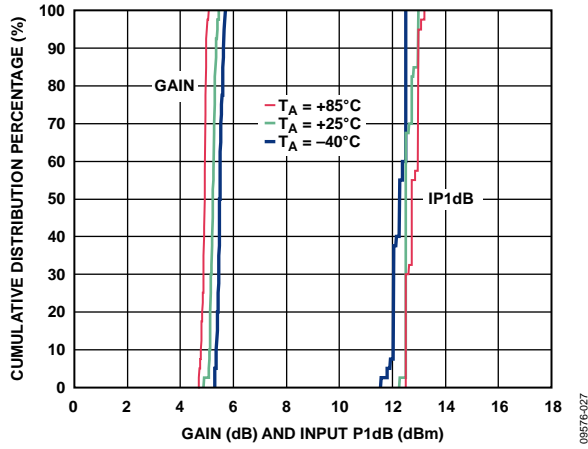

Figure 27. Gain and Input P1dB

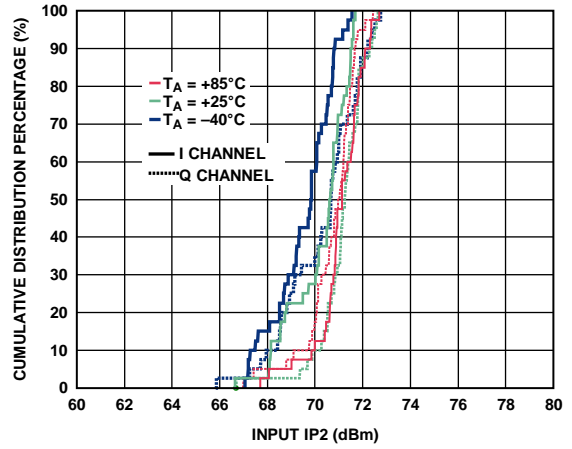

Figure 30. Input IP2

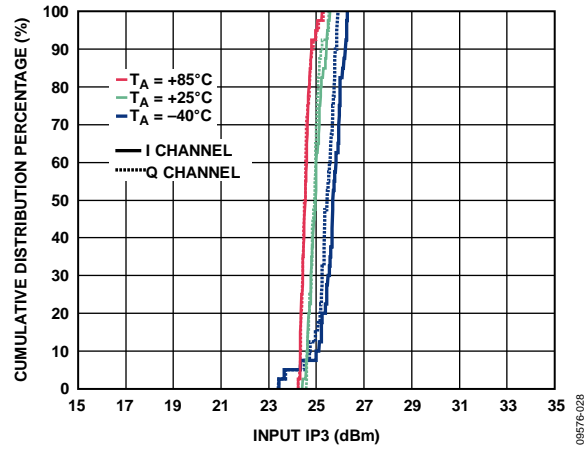

Figure 28. Input IP3

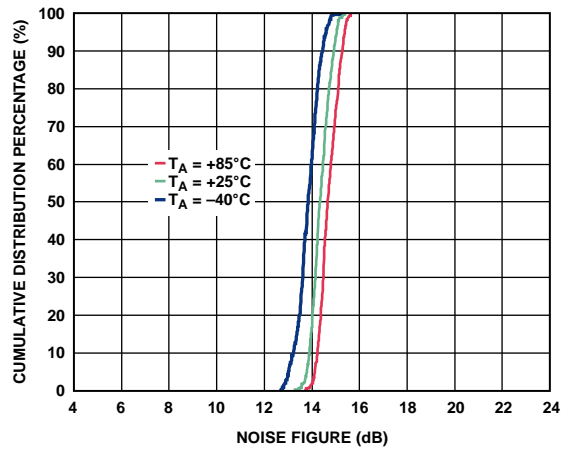

Figure 31. Noise Figure

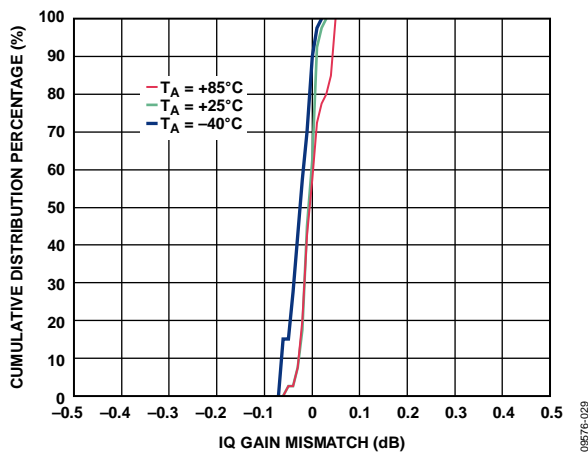

Figure 29. IQ Gain Mismatch

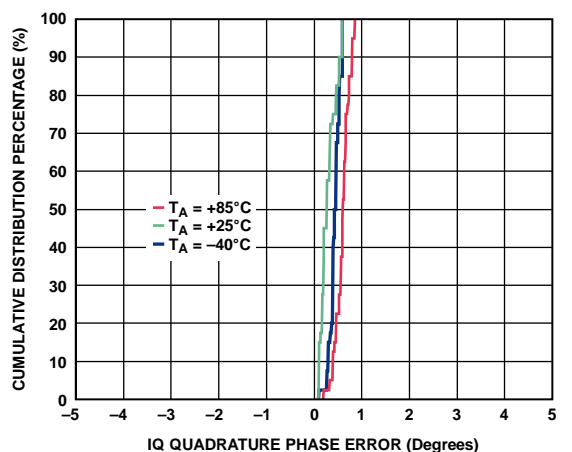

Figure 32. IQ Quadrature Phase Error

CIRCUIT DESCRIPTION

The ADRF6801 integrates a high performance IQ demodulator with a state-of-the-art fractional-N PLL. The PLL also integrates a low noise VCO. The SPI port allows the user to control the fractional-N PLL functions, the demodulator LO divider functions, and optimization functions, as well as allowing for an externally applied LO.

The ADRF6801 uses a high performance mixer core that results in an exceptional input IP3 and input P1dB, with a very low output noise floor for excellent dynamic range.

LO QUADRATURE DRIVE

A signal at 2× the desired mixer LO frequency is delivered to a divide-by-2 quadrature phase splitter followed by limiting amplifiers which then drive the I and Q mixers, respectively.

V-TO-I CONVERTER

The RF input signal is applied to an on-chip balun which then provides both a ground referenced, 50 Ω single-ended input impedance and a differential voltage output to a V-to-I converter that converts the differential voltages to differential output currents. These currents are then applied to the emitters of the Gilbert cell mixers.

MIXERS

The ADRF6801 has two double-balanced mixers: one for the in-phase channel (I channel) and one for the quadrature channel (Q channel). These mixers are based on the Gilbert cell design of four cross-connected transistors. The output currents from the two mixers are summed together in the resistive loads that then feed into the subsequent emitter follower buffers.

EMITTER FOLLOWER BUFFERS

The output emitter followers drive the differential I and Q signals off chip. The output impedance is set by on-chip 12 Ω series resistors that yield a 24 Ω differential output impedance for each baseband port. The fixed output impedance forms a voltage divider with the load impedance that reduces the effective gain. For example, a 500 Ω differential load has ~0.5 dB lower effective gain than with a high (10 kΩ) differential load impedance.

The common-mode dc output levels of the emitter followers are set from VCCBB via the voltage drop across the mixer load resistors, the V_{BE} of the output emitter follower, and the voltage drop across the 12 Ω series resistor.

BIAS CIRCUITRY

There are several band gap reference circuits and three low dropout regulators (LDOs) in the ADRF6801 that generate the reference currents and voltages used by different sections. The first of the LDOs is the 2.5 V LDO, which is always active and provides the 2.5 V supply rail used by the internal digital logic blocks. The 2.5 V LDO output is connected to DECL2 (Pin 9) for the user to provide external decoupling.

The second LDO is the VCO LDO, which acts as the positive supply rail for the internal VCO. The VCO LDO output is connected to DECL2 (Pin 40) for the user to provide external decoupling. The VCO LDO can be powered down by setting Register 6, DB18 = 0, which allows the user to save power when not using the VCO.

The third LDO is the 3.3 V LDO, which acts as the 3.3 V positive supply rail for the reference input, phase frequency detector, and charge pump circuitry. The 3.3 V LDO output is connected to DECL3 (Pin 2) for the user to provide external decoupling. The 3.3 V LDO can be powered down by setting Register 6, DB19 = 0, which allows the user to save power when not using the VCO. The demodulator also has a bias circuit that supplies bias current for the mixer V-to-I stage, which then sets the bias for the mixer core. The demodulator bias cell can also be shut down by setting Register 5, DB7 = 0.

REGISTER STRUCTURE

The ADRF6801 provides access to its many programmable features through a 3-wire SPI control interface that is used to program the seven internal registers. The minimum delay and hold times are shown in the timing diagram (see Figure 2). The SPI provides digital control of the internal PLL/VCO as well as several other features related to the demodulator core, on-chip referencing, and available system monitoring functions. The MUXOUT pin provides a convenient, single-pin monitor output signal that can be used to deliver a PLL lock-detect signal or an internal voltage proportional to the local junction temperature.

Note that internal calibration for the PLL must run when the ADRF6801 is initialized at a given frequency. This calibration is run automatically whenever Register 0, Register 1, or Register 2 is programmed. Because the other registers affect PLL performance, Register 0, Register 1, and Register 2 must always be programmed last. For ease of use, starting the initial programming with Register 6 and then programming the registers in descending order, ending with Register 0, is recommended. Once the PLL and other settings are programmed, the user can change the PLL frequency simply by programming Register 0, Register 1, or Register 2 as necessary.

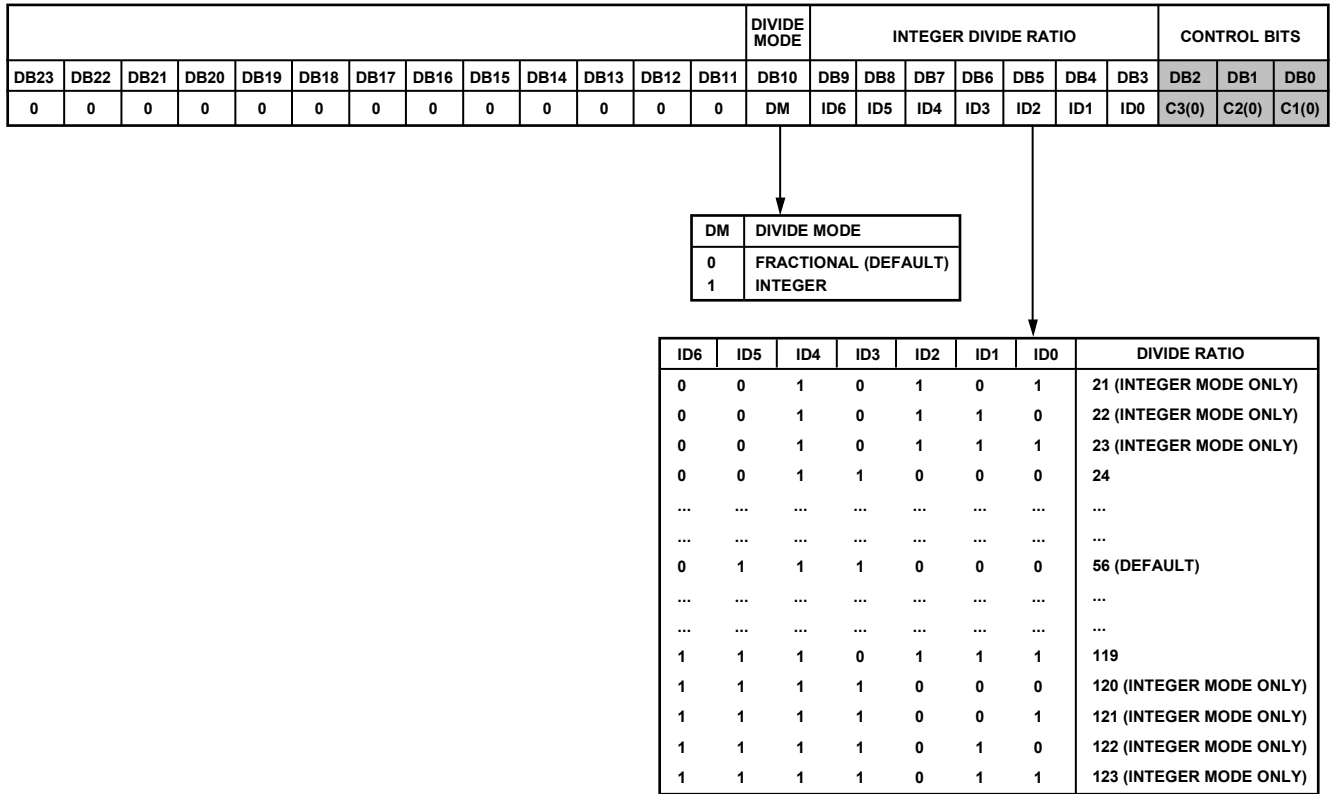

Figure 33. Integer Divide Control Register (R0)

Register 0—Integer Divide Control

With R0[2:0] set to 000, the on-chip integer divide control register is programmed as shown in Figure 33. The internal VCO frequency (f_{VCO}) equation is

$$f_{VCO} = f_{PFD} \times (INT + (FRAC/MOD)) \times 2 \tag{1}$$

where:

- f_{VCO} is the output frequency of the internal VCO.
- INT is the preset integer divide ratio value (21 to 123 for integer mode, 24 to 119 for fractional mode).
- MOD is the preset fractional modulus (1 to 2047).
- $FRAC$ is the preset fractional divider ratio value (0 to $MOD - 1$).

The integer divide ratio sets the INT value in Equation 1. The INT , $FRAC$, and MOD values make it possible to generate output frequencies that are spaced by fractions of the PFD frequency. Note that the demodulator LO frequency is given by $f_{LO} = f_{VCO}/4$.

Divide Mode

Divide mode determines whether fractional mode or integer mode is used. In integer mode, the VCO output frequency, f_{VCO} , is calculated by

$$f_{VCO} = f_{PFD} \times (INT) \times 2 \tag{2}$$

09576-031

Register 1—Modulus Divide Control

With R1[2:0] set to 001, the on-chip modulus divide control register is programmed as shown in Figure 34. The MOD value is the preset fractional modulus ranging from 1 to 2047.

										MODULUS DIVIDE RATIO										CONTROL BITS			
DB23	DB22	DB21	DB20	DB19	DB18	DB17	DB16	DB15	DB14	DB13	DB12	DB11	DB10	DB9	DB8	DB7	DB6	DB5	DB4	DB3	DB2	DB1	DB0
0	0	0	0	0	0	0	0	0	0	MD10	MD9	MD8	MD7	MD6	MD5	MD4	MD3	MD2	MD1	MD0	C3(0)	C2(0)	C1(1)

MD10	MD9	MD8	MD7	MD6	MD5	MD4	MD3	MD2	MD1	MD0	MODULUS VALUE
0	0	0	0	0	0	0	0	0	0	1	1
0	0	0	0	0	0	0	0	0	1	0	2
...
...
1	1	0	0	0	0	0	0	0	0	0	1536 (DEFAULT)
...
...
1	1	1	1	1	1	1	1	1	1	1	2047

Figure 34. Modulus Divide Control Register (R1)

Register 2—Fractional Divide Control

With R2[2:0] set to 010, the on-chip fractional divide control register is programmed as shown in Figure 35. The FRAC value is the preset fractional modulus ranging from 0 to MOD - 1.

										FRACTIONAL DIVIDE RATIO										CONTROL BITS			
DB23	DB22	DB21	DB20	DB19	DB18	DB17	DB16	DB15	DB14	DB13	DB12	DB11	DB10	DB9	DB8	DB7	DB6	DB5	DB4	DB3	DB2	DB1	DB0
0	0	0	0	0	0	0	0	0	0	FD10	FD9	FD8	FD7	FD6	FD5	FD4	FD3	FD2	FD1	FD0	C3(0)	C2(1)	C1(0)

FD10	FD9	FD8	FD7	FD6	FD5	FD4	FD3	FD2	FD1	FD0	FRACTIONAL VALUE
0	0	0	0	0	0	0	0	0	0	0	0
0	0	0	0	0	0	0	0	0	0	1	1
...
...
0	1	1	0	0	0	0	0	0	0	0	768 (DEFAULT)
...
...
FRACTIONAL VALUE MUST BE LESS THAN MODULUS											<MOD

Figure 35. Fractional Divide Control Register (R2)

Register 3—Σ-Δ Modulator Dither Control

With R3[2:0] set to 011, the on-chip Σ-Δ modulator dither control register is programmed as shown in Figure 36. The dither restart value can be programmed from 0 to 217 to 1, though a value of 1 is typically recommended.

DITHER MAGNITUDE			DITHER ENABLE	DITHER RESTART VALUE																CONTROL BITS			
DB23	DB22	DB21	DB20	DB19	DB18	DB17	DB16	DB15	DB14	DB13	DB12	DB11	DB10	DB9	DB8	DB7	DB6	DB5	DB4	DB3	DB2	DB1	DB0
0	DITH1	DITH0	DEN	DV16	DV15	DV14	DV13	DV12	DV11	DV10	DV9	DV8	DV7	DV6	DV5	DV4	DV3	DV2	DV1	DV0	C3(0)	C2(1)	C1(1)

DEN	DITHER ENABLE
0	DISABLE
1	ENABLE (DEFAULT, RECOMMENDED)

DITH1	DITH0	DITHER MAGNITUDE
0	0	15 (DEFAULT)
0	1	7
1	0	3
1	1	1 (RECOMMENDED)

DV16	DV15	DV14	DV13	DV12	DV11	DV10	DV9	DV8	DV7	DV6	DV5	DV4	DV3	DV2	DV1	DV0	DITHER RESTART VALUE
0	0	0	0	0	0	0	0	0	0	0	0	0	0	0	0	1	0x00001 (DEFAULT)
...
...
1	1	1	1	1	1	1	1	1	1	1	1	1	1	1	1	1	0x1FFFF

Figure 36. Σ-Δ Modulator Dither Control Register (R3)

Register 4—Charge Pump, PFD, and Reference Path Control

With R4[2:0] set to 100, the on-chip charge pump, PFD, and reference path control register is programmed as shown in Figure 37.

The charge pump current is controlled by the base charge pump current ($I_{CP,BASE}$) and the value of the charge pump current multiplier ($I_{CP,MULT}$).

The base charge pump current can be set using an internal or external resistor (according to Bit DB18 of Register 4). When using an external resistor, the value of $I_{CP,BASE}$ can be varied according to

$$R_{SET} [\Omega] = \left[\frac{217.4 \times I_{CP,BASE}}{250} \right] - 37.8$$

The actual charge pump current can be programmed to be a multiple (1, 2, 3, or 4) of the charge pump base current. The multiplying value ($I_{CP,MULT}$) is equal to 1 plus the value of the DB11 and DB10 bits in Register 4.

The PFD phase offset multiplier ($\theta_{PFD,OFF}$), which is set by Bit DB16 to Bit DB12 of Register 4, causes the PLL to lock with a nominally fixed phase offset between the PFD reference signal

and the divided-down VCO signal. This phase offset is used to linearize the PFD-CP transfer function and can improve fractional spurs. The magnitude of the phase offset is determined by

$$|\Delta\Phi|[\text{deg}] = 22.5 \frac{\theta_{PFD,OFF}}{I_{CP,MULT}}$$

Finally, the phase offset can be either positive or negative depending on the value of the DB17 bit in Register 4.

The reference frequency applied to the PFD can be manipulated using the internal reference path source. The external reference frequency applied can be internally scaled in frequency by 2×, 1×, 0.5×, or 0.25×. This allows a broader range of reference frequency selections while keeping the reference frequency applied to the PFD within an acceptable range.

The ADRF6801 also provides a MUXOUT pin that can be programmed to output a selection of several internal signals. The default mode provides a lock-detect output that allows users to verify when the PLL has locked to the target frequency. In addition, several other internal signals can be routed to the MUXOUT pin as described in Figure 37.

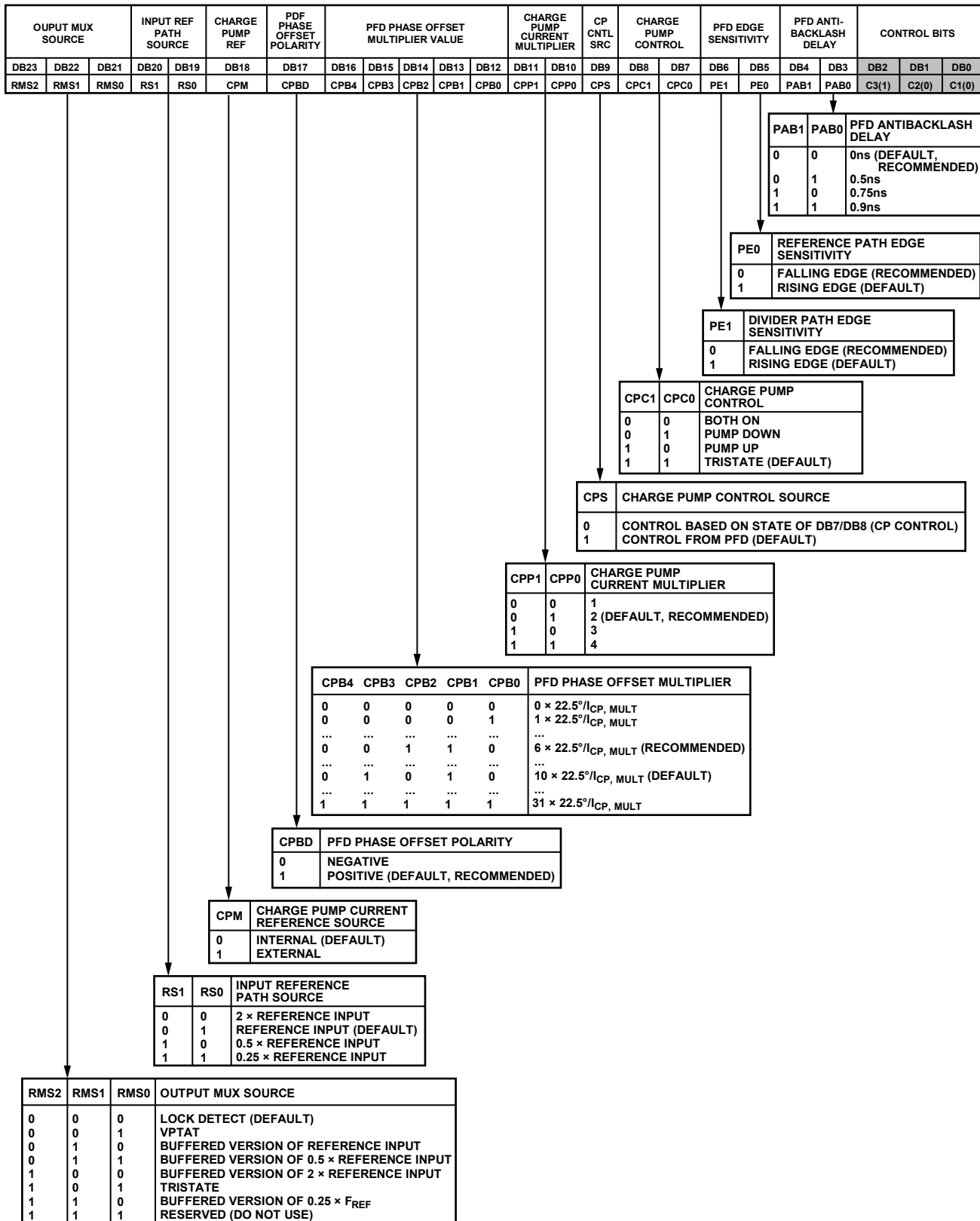

Figure 37. Charge Pump, PFD, and Reference Path Control Register (R4)

Register 5—LO Path and Demodulator Control

Register 5 controls whether the LOIP and LOIN pins act as an input or output, whether the divider before the polyphase divider is in divide-by-1 or divide-by-2, and whether the demodulator bias circuitry is enabled as detailed in Figure 38.

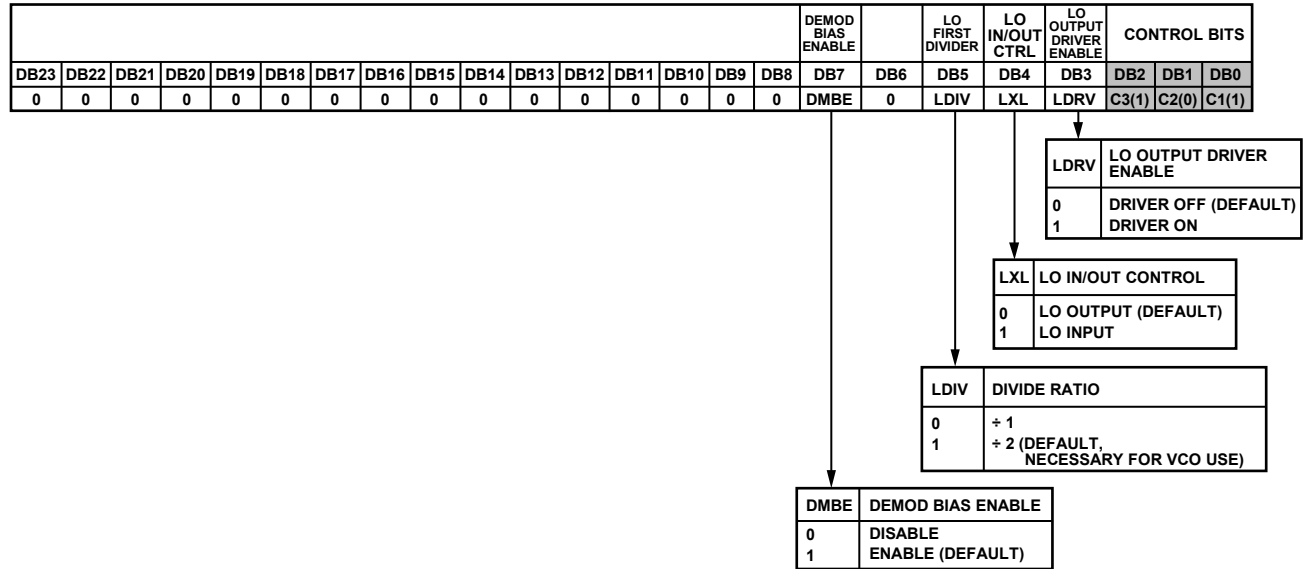

Figure 38. LO Path and Demodulator Control Register (R5)

09576-036

Register 6—VCO Control and Enables

With R6[2:0] set to 110, the VCO control and enables register is programmed as shown in Figure 39.

VCO band selection is normally selected based on BANDCAL calibration; however, the VCO band can be selected directly using Register 6. The VCO BS SRC determines whether the BANDCAL calibration determines the optimum VCO tuning band or if the external SPI interface is used to select the VCO tuning band based on the value of the VCO band select.

The VCO amplitude can be controlled through Register 6. The VCO amplitude setting can be controlled between 0 and 31 decimal, with a default value of 24.

The internal VCO can be disabled using Register 6. The internal VCO LDO can be disabled if an external clean 3.0 V supply is available.

The internal charge pump can be disabled through Register 6. Normally, the charge pump is enabled.

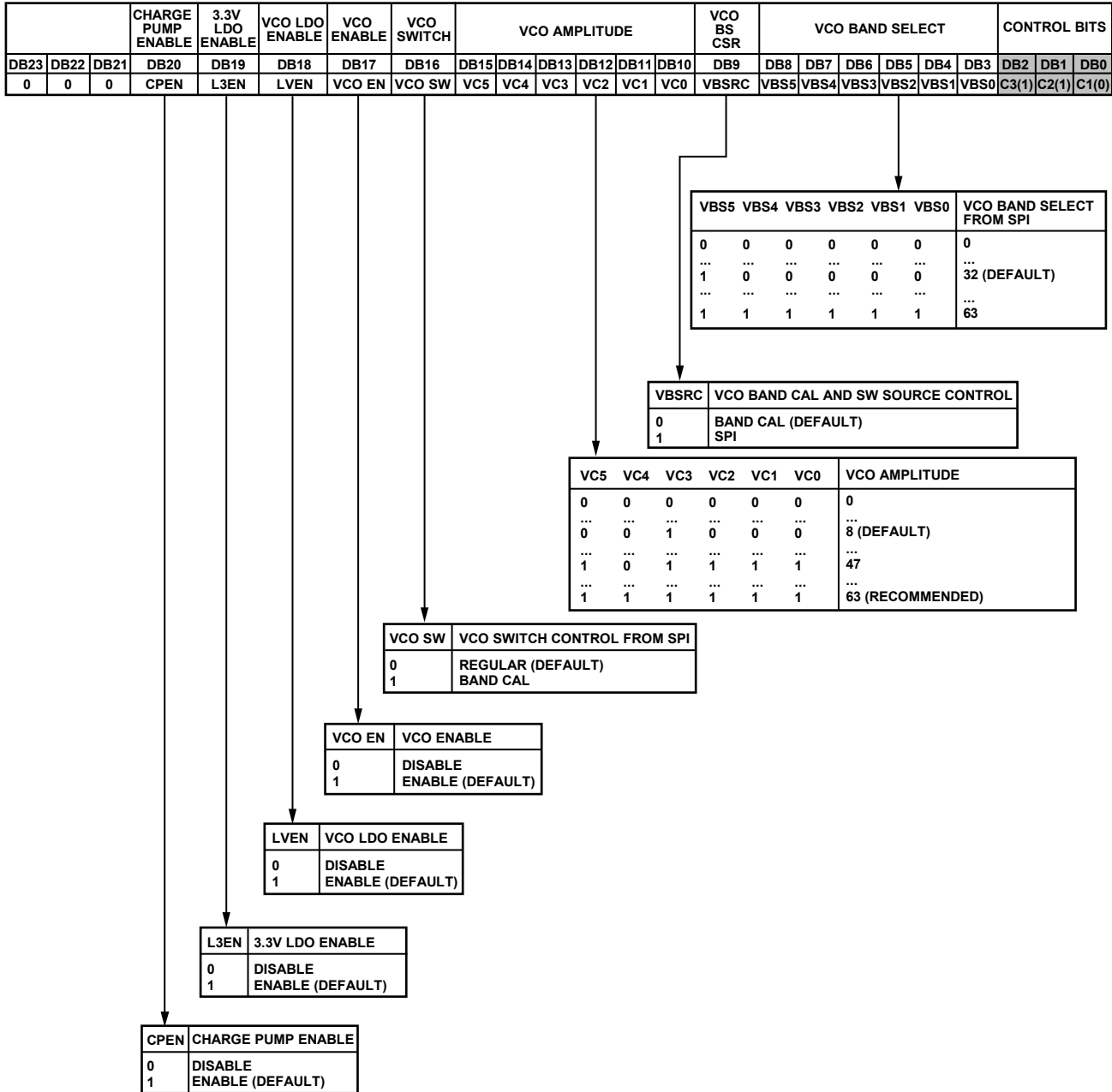

Figure 39. VCO Control and Enables (R6)

09576-037

APPLICATIONS INFORMATION

BASIC CONNECTIONS

The basic circuit connections for a typical ADRF6801 application are shown in Figure 40.

SUPPLY CONNECTIONS

The ADRF6801 has several supply connections and on-board regulated reference voltages that should be bypassed to ground using low inductance bypass capacitors located in close proximity to the supply and reference pins of the ADRF6801. Specifically Pin 1, Pin 2, Pin 9, Pin 10, Pin 17, Pin 22, Pin 27, Pin 29, Pin 34, and Pin 40 should be bypassed to ground using individual bypass capacitors. Pin 40 is the decoupling pin for the on-board VCO LDO, and for best phase noise performance, several bypass capacitors ranging from 100 pF to 10 μ F may help to improve phase noise performance. For additional details on bypassing the supply nodes, see the evaluation board schematic in Figure 42.

SYNTHESIZER CONNECTIONS

The ADRF6801 includes an on-board VCO and PLL for LO synthesis. An external reference must be applied for the PLL to operate. A 1 V p-p nominal external reference must be applied to Pin 6 through an ac coupling capacitor. The reference is compared to an internally divided version of the VCO output frequency to create a charge pump error current to control and lock the VCO. The charge pump output current is filtered and converted to a control voltage through the external loop filter that is then applied to the VTUNE pin (Pin 39). ADIsimPLL™ can be a helpful tool when designing the external charge pump loop filter. The typical Kv of the VCO, the charge pump output current magnitude, and PFD frequency should all be considered when designing the loop filter. The charge pump current magnitude can be set internally or with an external RSET resistor connected to Pin 5 and ground, along with the internal digital settings applied to the PLL (see the Register 4—Charge Pump, PFD, and Reference Path Control section for more details).

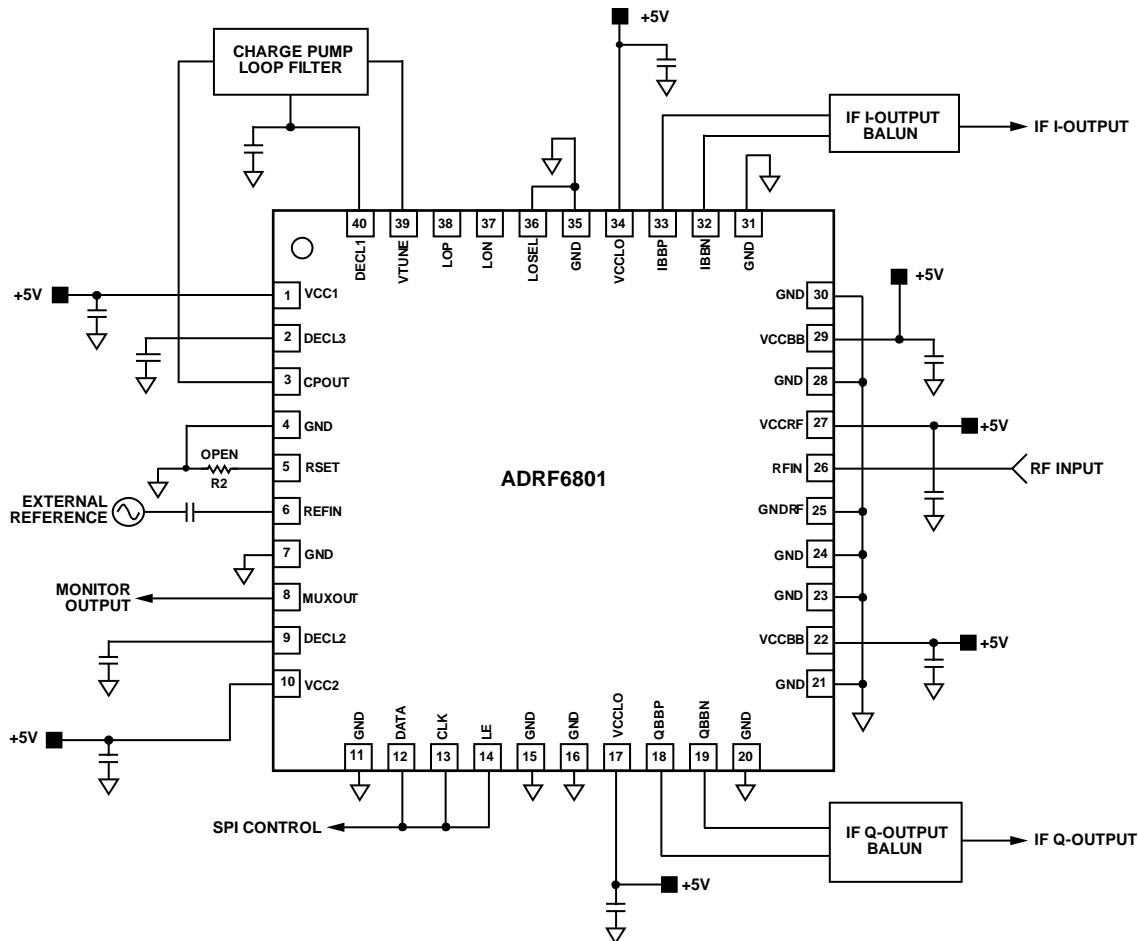

Figure 40. Basic Connections

08576-041

I/Q OUTPUT CONNECTIONS

The ADRF6801 has I and Q baseband outputs. Each output stage consists of emitter follower output transistors with a low differential impedance of 24 Ω and can source up to 12 mA p-p differentially. A Mini-Circuits TCM9-1+ balun is used to transform a single-ended 50 Ω load impedance into a nominal 450 Ω differential impedance.

RF INPUT CONNECTIONS

The ADRF6801 is to be driven single-ended and can be either dc coupled or ac coupled. There is an on-chip ground referenced balun that converts the applied single-ended signal to a differential signal that is then input to the RF V-to-I converter.

CHARGE PUMP/VTUNE CONNECTIONS

The ADRF6801 uses a loop filter to create the VTUNE voltage for the internal VCO. The loop filter in its simplest form is an integrating capacitor. It converts the current mode error signal coming out of the CPOUT pin into a voltage to control the VCO via the VTUNE voltage. The stock filter on the evaluation board has a bandwidth of 130 kHz. The loop filter contains seven components, four capacitors, and three resistors. Changing the values of these components changes the bandwidth of the loop filter. Note that to obtain the approximately 2.5 kHz loop bandwidth, the user can change the values of the following components on the evaluation board to as follows: C14 = 0.1 μ F, R10 = 68 Ω , C15 = 4.7 μ F, R9 = 270 Ω , C13 = 47 nF, R60 = 0 Ω , C4 = open.

LO SELECT INTERFACE

The ADRF6801 has the option of either monitoring a scaled version of the internally generated LO (LOSEL pin driven high at 3.3 V) or providing an external LO source (LOSEL pin driven low to ground, the LDRV bit in Register 5 set low, and the LXL bit in Register 5 set high). See the Pin Configuration and Function Descriptions section for full operation details.

EXTERNAL LO INTERFACE

The ADRF6801 provides the option to use an external signal source for the LO into the IQ demodulating mixer core. It is important to note that the applied LO signal is divided down by either 2 or 4 depending on the LO path divider bit, LDIV, in Register 5, prior to the actual IQ demodulating mixer core. The divider is determined by the register settings in the LO path and mixer control register (see the Register 5—LO Path and Demodulator Control section). The LO input pins (Pin 37 and Pin 38) present a broadband differential 50 Ω input impedance. The LOP and LON input pins must be ac-coupled. This is achieved on the evaluation board via a Mini-Circuits TC1-1-13+ balun with a 1:1 impedance ratio. When not in use, the LOP and LON pins can be left unconnected.

SETTING THE FREQUENCY OF THE PLL

The frequency of the VCO/PLL, once locked, is governed by the values programmed into the PLL registers, as follows:

$$f_{PLL} = f_{PFD} \times 2 \times (INT + FRAC/MOD)$$

where:

f_{PLL} is the frequency at the VCO when the loop is locked.

f_{PFD} is the frequency at the input of the phase frequency detector.

INT is the integer divide ratio programmed into Register 0.

MOD is the modulus divide ratio programmed into Register 1.

$FRAC$ is the fractional value programmed into Register 2.

The practical lower limit of the reference input frequency is determined by the combination of the desired f_{PLL} and the maximum programmable integer divide ratio of 119 and reference input frequency multiplier of 2. For a maximum f_{PLL} of 4600 MHz,

$$f_{REF} > \sim f_{PLL}/(119 \times 2 \times 2), \text{ or } 9.7 \text{ MHz.}$$

A lock detect signal is available as one of the selectable outputs through the MUXOUT pin, with logic high signifying that the loop is locked.

When the internal VCO is used, the actual LO frequency is

$$f_{LO} = f_{PLL}/4$$

REGISTER PROGRAMMING

Because Register 6 controls the powering of the VCO and charge pump, it must be programmed once before programming the PLL frequency (Register 0, Register 1, and Register 2).

The registers should be programmed starting with the highest register first and then sequentially down to Register 0 last. When Register 0, Register 1, or Register 2 is programmed, an internal VCO calibration is initiated that must execute when the other registers are set. Therefore, the order must be Register 6, Register 5, Register 4, Register 3, Register 2, Register 1, and then Register 0. Whenever Register 0, Register 1, or Register 2 is written to, it initializes the VCO calibration (even if the value in these registers does not change). After the device has been powered up and the registers configured for the desired mode of operation, only Register 0, Register 1, or Register 2 must be programmed to change the LO frequency.

If none of the register values is changing from their defaults, there is no need to program them.

EVM MEASUREMENTS

EVM is a measure used to quantify the performance of a digital radio transmitter or receiver. A signal received by a receiver has all constellation points at their ideal locations; however, various imperfections in the implementation (such as magnitude imbalance, noise floor, and phase imbalance) cause the actual constellation points to deviate from their ideal locations.

In general, a demodulator exhibits three distinct EVM limitations vs. received input signal power. As signal power increases, the distortion components increase. At large enough signal levels, where the distortion components due to the harmonic non-linearities in the device are falling in-band, EVM degrades as signal levels increase. At medium signal levels, where the demodulator behaves in a linear manner and the signal is well above any notable noise contributions, the EVM has a tendency to reach an optimal level determined dominantly by either quadrature accuracy and I/Q gain match of the demodulator or the precision of the test equipment. As signal levels decrease, such that the noise is the major contribution, the EVM performance vs. the signal level exhibits a decibel-for-decibel degradation with decreasing signal level. At lower signal levels, where noise proves to be the dominant limitation, the decibel EVM proves to be directly proportional to the SNR.

The basic test setup to test EVM for the ADRF6801 consisted of an Agilent E4438C, which was used as a signal source. The 900 MHz modulated signal was driven single ended into the RFIN SMA connector of the ADRF6801 evaluation board. The IQ baseband outputs were taken differentially into two AD8130 difference amplifiers to convert the differential signals into single-ended signals. A Hewlett Packard 89410A VSA was used to sample and calculate the EVM of the signal. The ADRF6801 IQ baseband output pins were presented with a 450 Ω differential load impedance.

The ADRF6801 shows excellent EVM performance for 16 QAM. Figure 41 shows the EVM of the ADRF6801 being better than -40 dB over a RF input range of about $+35$ dB for the 16 QAM modulated signal at a 10 MHz symbol rate. The pulse shaping filter's roll-off (α) was set to 0.35.

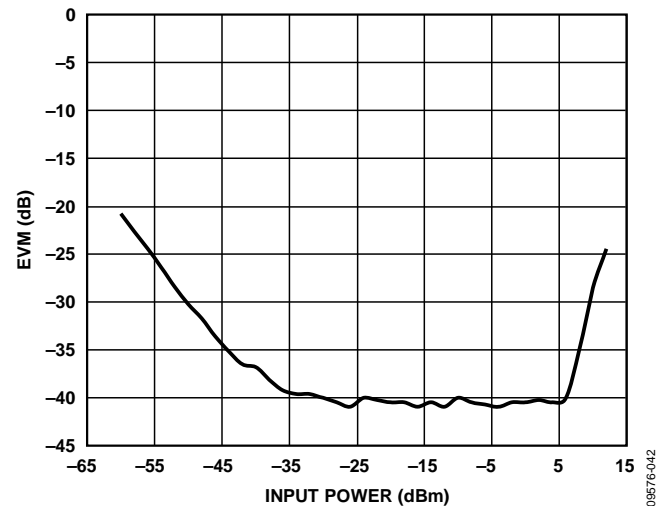

Figure 41. EVM vs. Input Power, EVM Measurements at $f_{RF} = 900$ MHz; $f_{IF} = 0$ MHz (that is, Direct Down Conversion); 16 QAM; Symbol Rate = 10 MHz

EVALUATION BOARD LAYOUT AND THERMAL GROUNDING

An evaluation board is available for testing the ADRF6801. The evaluation board schematic is shown in Figure 42. Table 5 provides

the component values and suggestions for modifying the component values for the various modes of operation.

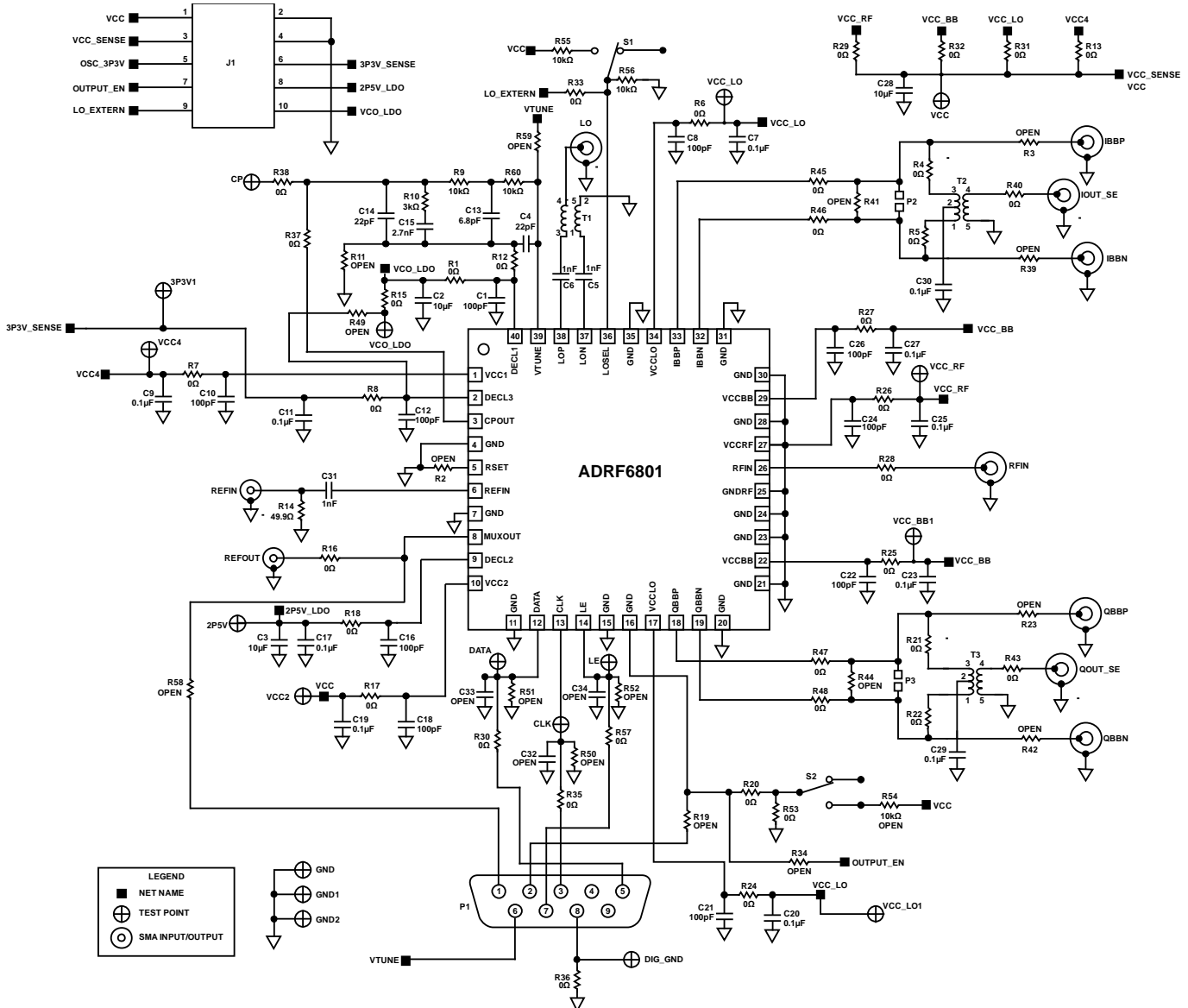

Figure 42. Evaluation Board Schematic

The package for the ADRF6801 features an exposed paddle on the underside that should be well soldered to an exposed opening in the solder mask on the evaluation board. Figure 43 illustrates the dimensions used in the layout of the ADRF6801 footprint on the ADRF6801 evaluation board (1 mil. = 0.0254 mm).

Note the use of nine via holes on the exposed paddle. These ground vias should be connected to all other ground layers on the evaluation board to maximize heat dissipation from the device package. Under these conditions, the thermal impedance of the ADRF6801 was measured to be approximately 30°C/W in still air.

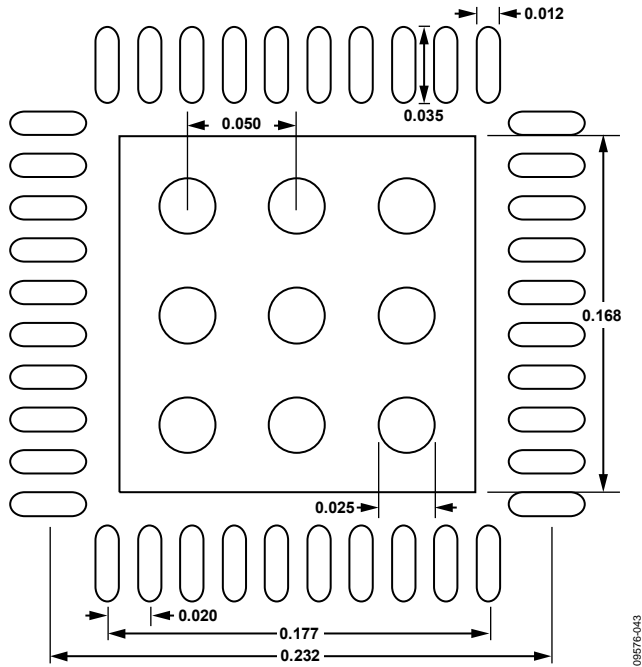

Figure 43. Evaluation Board Layout Dimensions for the ADRF6801 Package

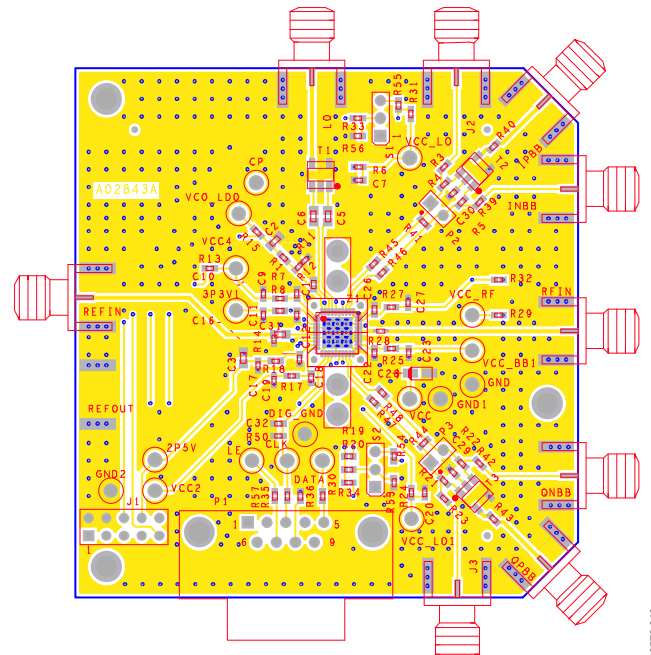

Figure 44. ADRF6801 Evaluation Board Top Layer

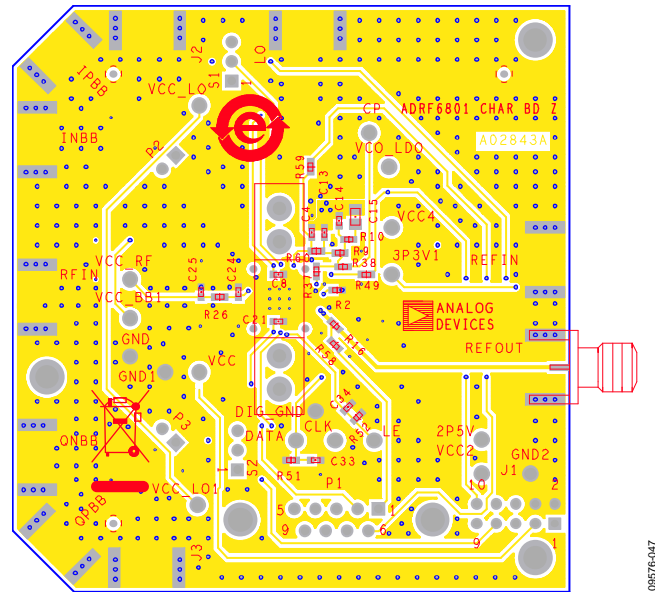

Figure 45. ADRF6801 Evaluation Board Bottom Layer

Table 5. Evaluation Board Configuration Options

Component	Function	Default Condition
VCC, VCC2, VCC4, VCO_LDO, VCC_LO, VCC_LO1, VCC_RF, VCC_BB1, 3P3V1, 2P5V, CLK, DATA, LE, CP, DIG_GND, GND, GND1, GND2	Power supply, ground and other test points. Connect a 5 V supply to VCC.	VCC, VCC2, VCC4, VCC_LO, VCC_RF, VCC_BB1, VCC_LO1, VCO_LDO, 3P3V1, 2P5V = Components Corporation TP-104-01-02, CP, LE, CLK, DATA = Components Corporation TP-104-01-06, GND, GND1, GND2, DIG_GND = Components Corporation TP-104-01-00
R1, R6, R7, R8, R13, R15, R17, R18, R24, R25, R26, R27, R29, R31, R32, R36, R49	Power supply decoupling. Shorts or power supply decoupling resistors.	R1, R6, R7, R8 = 0 Ω (0402), R13, R15, R17 = 0 Ω (0402), R18, R24, R25, R26, R27 = 0 Ω (0402), R29, R31, R32 = 0 Ω (0402), R36 = 0 Ω (0402),

Component	Function	Default Condition
C1, C2, C3, C7, C8, C9, C10, C11, C12, C16, C17, C18, C19, C20, C21, C22, C23, C24, C25, C26, C27, C28	The capacitors provide the required decoupling of the supply-related pins.	C1, C8, C10, C12 = 100 pF (0402), C16, C18, C21, C22 = 100 pF (0402), C24, C26 = 100 pF (0402), C7, C9, C11 = 0.1 μ F (0402), C17, C19, C20, C23 = 0.1 μ F (0402), C25, C27 = 0.1 μ F (0402), C3, C2 = 10 μ F (0603), C28 = 10 μ F (3216)
T1, C5, C6	External LO path. The T1 transformer provides single-ended-to-differential conversion. C5 and C6 provide the necessary ac coupling.	C5, C6 = 1 nF (0603), T1 = TC1-1-13+ Mini-Circuits
R16, R14, R58, C31	REFIN input path. R14 provides a broadband 50 Ω termination followed by C31, which provides the ac coupling into REFIN. R16 provides an external connectivity to the MUXOUT feature described in Register 4. R58 provides option for connectivity to the P1-6 line of a 9-pin D-sub connector for dc measurements.	R14 = 49.9 Ω (0402), R16 = 0 Ω (0402), R58 = open (0402), C31 = 1 nF (0603)
R2, R9, R10, R11, R12, R37, R38, R59, R60, C4, C14, C15, C13	Loop filter component options. A variety of loop filter topologies is supported using component placements C4, C13, C14, C15, R9, R10, and R60. R38 and R59 provide connectivity options to numerous test points for engineering evaluation purposes. R2 provides resistor programmability of the charge pump current (see Register 4 description). R37 connects the charge pump output to the loop filter. R12 references the loop filter to the VCO_LDO. Default values on board provide a loop filter bandwidth of roughly 130 kHz using a 26 MHz PFD frequency.	R12, R37, R38 = 0 Ω (0402), R59 = open (0402), R9, R60 = 10 k Ω (0402), R10 = 3 k Ω (0402), R2, R11 = open (0402), C13 = 6.8 pF (0402), C4, C14 = 22 pF (0402), C15 = 2.7 nF (1206)
R3, R4, R5, R21, R22, R23, R39, R40, R41, R42, R43, R44, R45, R46, R47, R48, C29, C30, T2, T3, P2, P3	IF I/Q output paths. The T2 and T3 baluns provide a 9:1 impedance transformation; therefore, with a 50 Ω load on the single-ended IOUT/QOUT side, the center tap side of the balun presents a differential 450 Ω to the ADRF6806. The center taps of the baluns are ac grounded through C29 and C30. The baluns create a differential-to-single-ended conversion for ease of testing and use, but an option to have straight differential outputs is achieved via populating R3, R39, R23, and R42 with 0 Ω resistors and removing R4, R5, R21, and R22. P2 and P3 are differential measurement test points (not to be used as jumpers).	R4, R5, R21, R22, = 0 Ω (0402), R40, R43, R45, R46 = 0 Ω (0402), R47, R48 = 0 Ω (0402), R3, R23, R39, R41, R42, R44 = open (0402), C29, C30, = 0.1 μ F (0402), T2, T3 = TCM9-1+ Mini-Circuits, P2, P3 = Samtec SSW-102-01-G-S
R28	RF input interface. R28 provides the single-ended RF input path to the on-chip RF input balun.	R28 = 0 Ω (0402)
R30, R35, R50, R51, R52, R57, C32, C33, C34, P1	Serial port interface. A 9-pin D-sub connector (P1) is provided for connecting to a host PC or control hardware. Optional RC filters can be installed on the CLK, DATA, and LE lines to filter the PC signals through R50 to R52 and C32 to C34. CLK, DATA, and LE signals can be observed via test points for debug purposes. R58 provides a connection to the MUXOUT for sensing lock detect through the P1 connector.	R30, R35, R57 = 0 Ω (0402), R50, R51, R52 = open (0402), C32, C33, C34 = open (0402), P1 = Tyco Electronics 5747840-3
R33, R55, R56, S1	LO select interface. The LOSEL pin, in combination with the LDRV and LXL bits in Register 5, controls whether the LOP and LON pins operate as inputs or outputs. A detailed description of how the LOSEL pin, LDRV bit, and the LXL bit work together to control the LOP and LON pins is found in Table 4 under the LOSEL pin description. Using the S1 switch, the user can pull LOSEL to a logic high ($V_{CC}/2$) or a logic low (ground). Resistors R55 and R56 form a resistor divider to provide a logic high of $V_{CC}/2$. LO select can also be controlled through Pin 9 of J1. The 0 Ω jumper, R33, must be installed to control LOSEL via J1.	R33 = 0 Ω (0402), R55, R56 = 10 k Ω (0402), S1 = Samtec TSW-103-08-G-S

Component	Function	Default Condition
J1	Engineering test points and external control. J1 is a 10-pin connector connected to various important points on the evaluation board that the user can measure or force voltages upon.	J1 = Molex Connector Corp. 10-89-7102
R19, R20, R34, R53, R54, S2	Provides ground connection for Pin 16.	R20, R53 = 0 Ω (0402), R34, R54 = open (0402), R19 = open, S2 = open

ADRF6801 SOFTWARE

The ADRF6801 evaluation board can be controlled from PCs using a USB adapter board, which is also available from Analog Devices, Inc. The USB adapter evaluation documentation and ordering information can be found on the [EVAL-ADF4XXXZ-USB](#) product page. The basic user interfaces are shown in Figure 46 and Figure 47.

The software allows the user to configure the ADRF6801 for various modes of operation. The internal synthesizer is controlled by clicking on any of the numeric values listed in **RF Section**.

Attempting to program **Ref Input Frequency**, **PFD Frequency**, **VCO Frequency (2xLO)**, **LO Frequency**, or other values in **RF Section** launches the **Synth Form** window shown in Figure 47. Using **Synth Form**, the user can specify values for **Local Oscillator Frequency (MHz)** and **External Reference Frequency (MHz)**. The user can also enable the LO output buffer and divider options from this menu. After setting the desired values, it is important to click **Upload all registers** for the new setting to take effect.



Figure 46. Evaluation Board Software Main Window

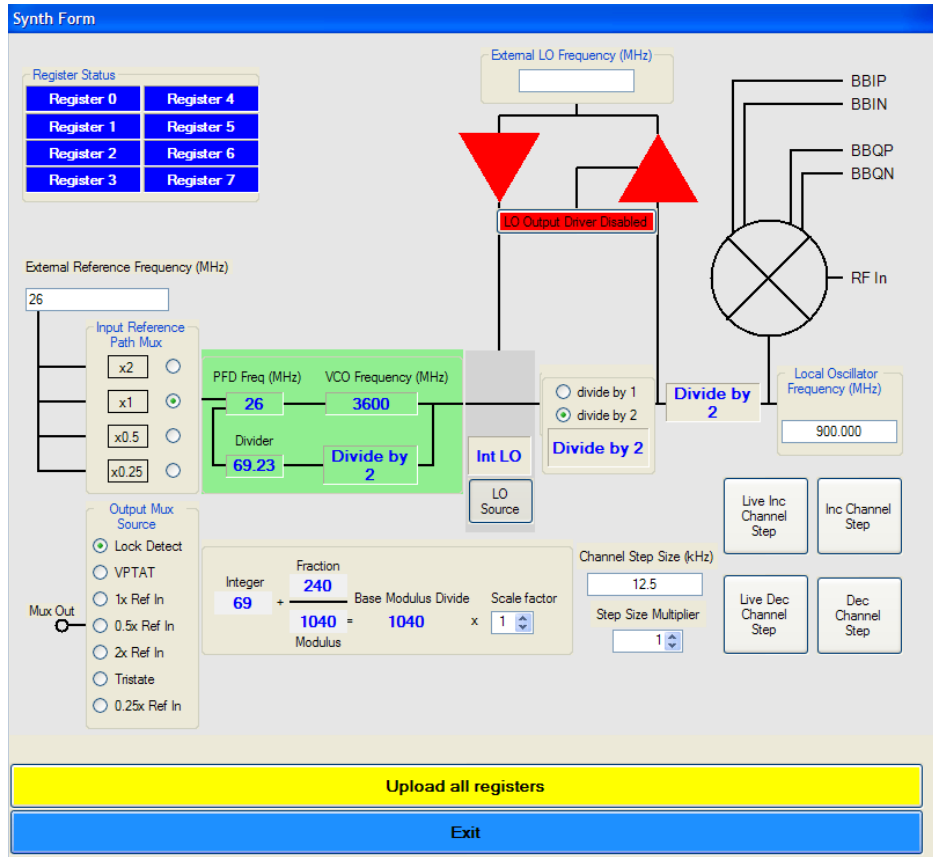

Figure 47. Evaluation Board Software Synth Form Window

CHARACTERIZATION SETUPS

Figure 48 to Figure 50 show the general characterization bench setups used extensively for the ADRF6801. The setup shown in Figure 48 was used to do the bulk of the testing. An automated Agilent VEE program was used to control the equipment over the IEEE bus. This setup was used to measure gain, input P1dB, output P1dB, input IP2, input IP3, IQ gain mismatch, IQ quadrature accuracy, and supply current. The evaluation board was used to perform the characterization with a Mini-Circuits TCM9-1+ balun on each of the I and Q outputs. When using the TCM9-1+ balun below 5 MHz (the specified 1 dB low frequency corner of the balun), distortion performance degrades; however, this is not the ADRF6801 degrading, merely the low frequency corner of the balun introducing distortion effects. Through this balun, the 9-to-1 impedance transformation effectively presented a 450 Ω differential load at each of the I and Q channels. The losses of the output baluns were de-embedded from all measurements.

To do phase noise and reference spur measurements, the setup shown in Figure 50 was used. Phase noise was measured at the baseband output (I or Q) at a baseband carrier frequency of 50 MHz. The baseband carrier of 50 MHz was chosen to allow phase noise measurements to be taken at frequencies of up to 20 MHz offset from the carrier. The noise figure was measured using the setup shown in Figure 49 at a baseband frequency of 10 MHz.

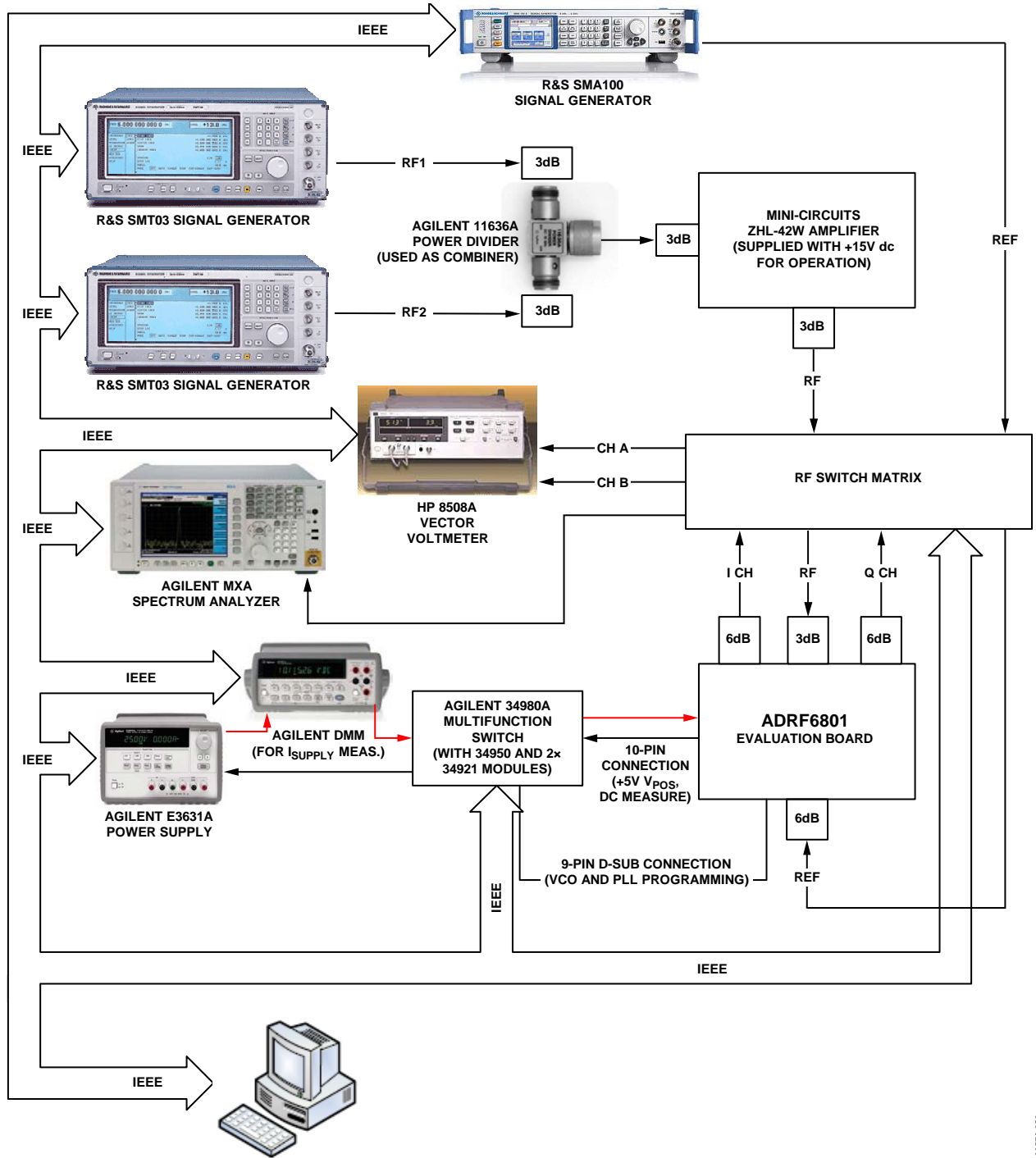

Figure 48. General Characterization Setup

09576-050

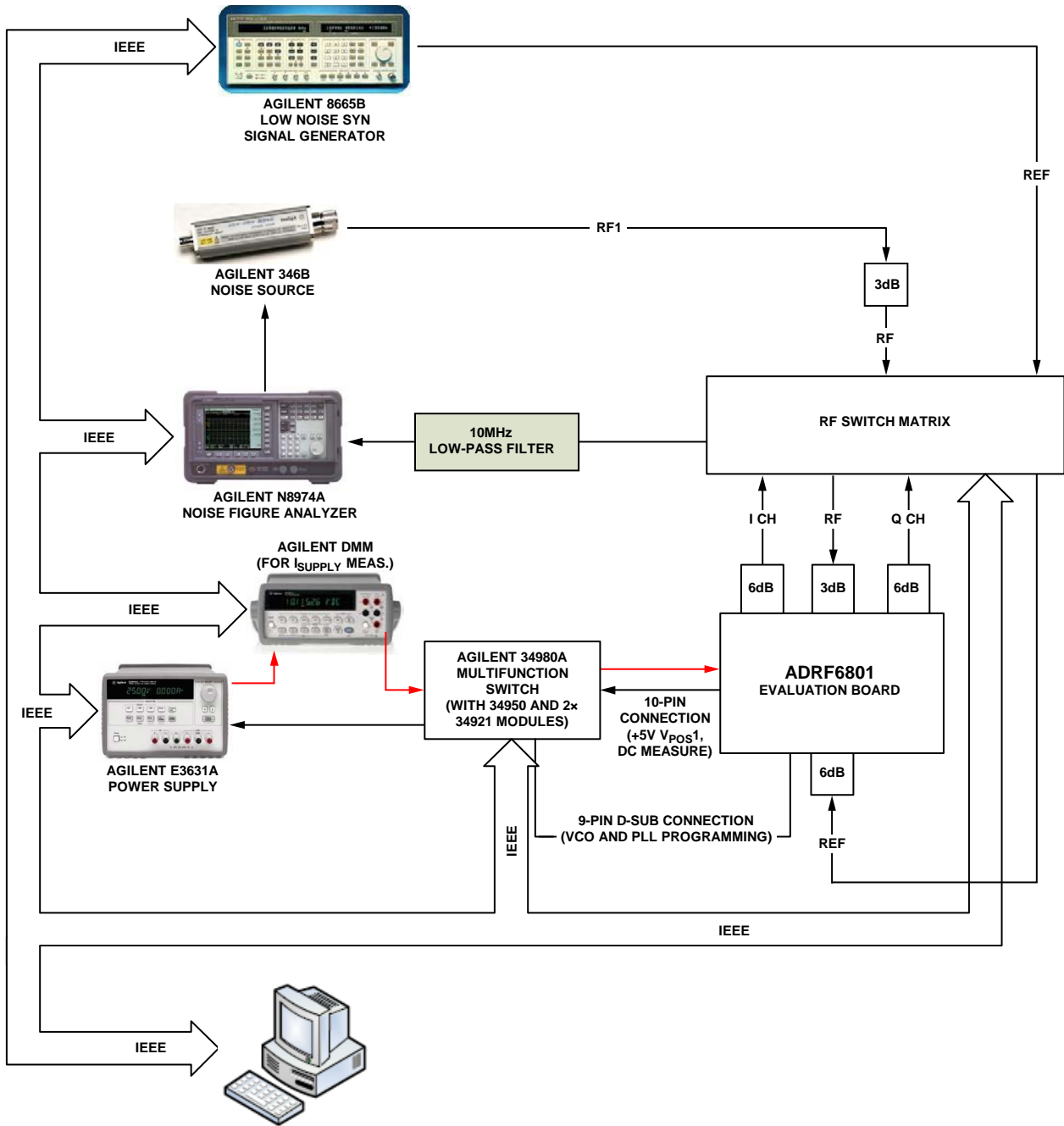

Figure 49. Noise Figure Characterization Setup

09576-651

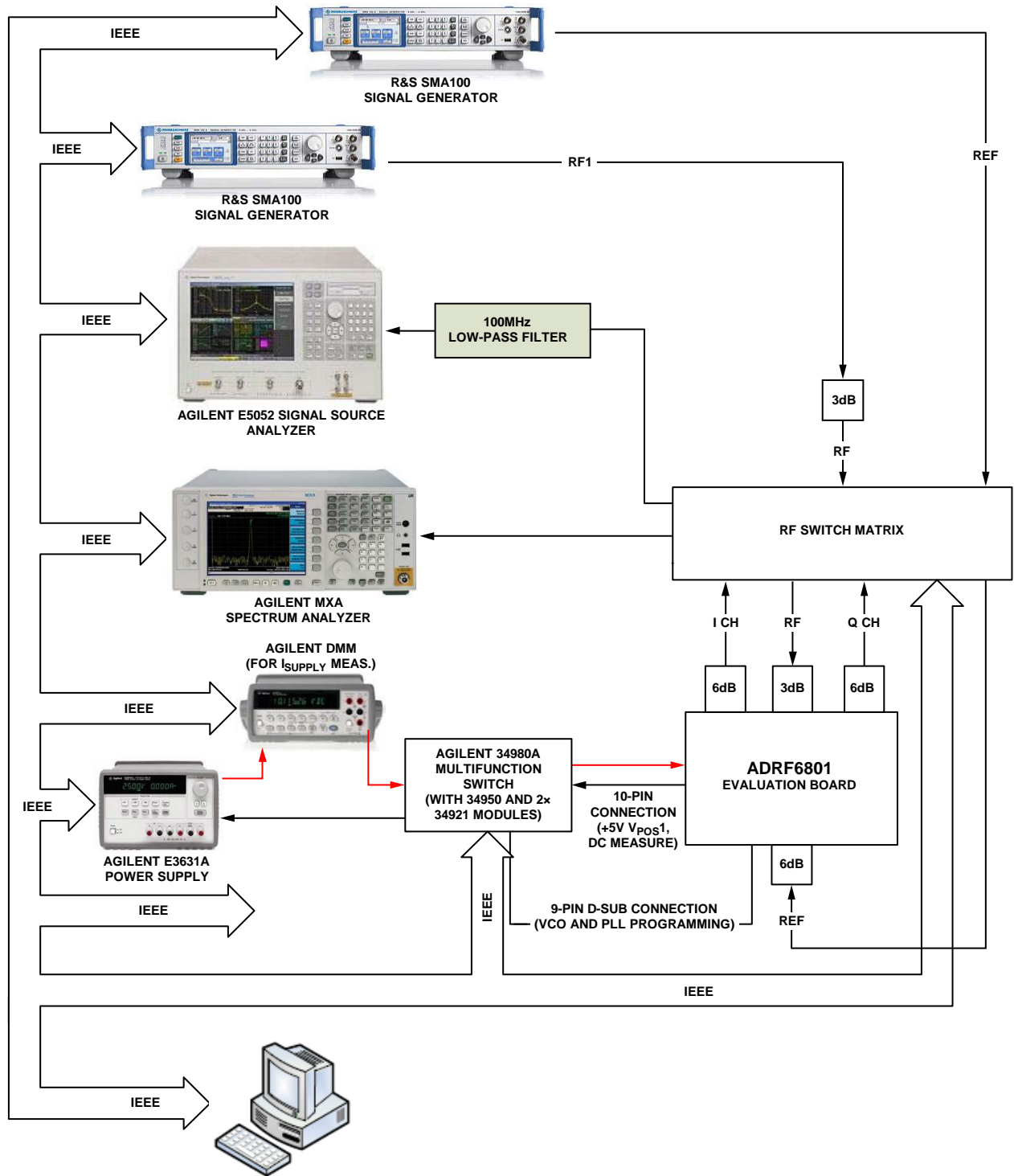
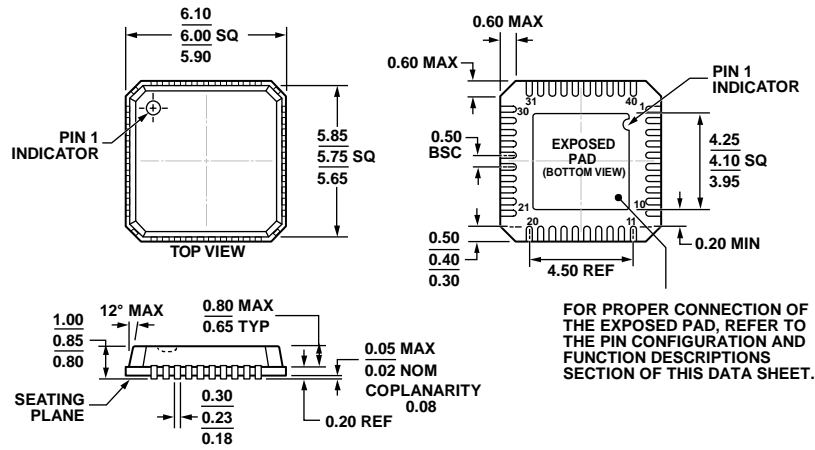

Figure 50. Phase Noise Characterization Setup

09576-052

OUTLINE DIMENSIONS



COMPLIANT TO JEDEC STANDARDS MO-220-VJJD-2

Figure 51. 40-Lead Lead Frame Chip Scale Package [LFCSP_VQ]
 6 mm × 6 mm Body, Very Thin Quad
 (CP-40-1)
 Dimensions shown in millimeters

ORDERING GUIDE

Model ¹	Temperature Range	Package Description	Package Option	Ordering Quantity
ADRF6801ACPZ-R7	-40°C to +85°C	40-Lead Lead Frame Chip Scale Package [LFCSP_VQ]	CP-40-1	750
ADRF6801-EVALZ		Evaluation Board		

¹ Z = RoHS Compliant Part.

Mouser Electronics

Authorized Distributor

Click to View Pricing, Inventory, Delivery & Lifecycle Information:

[Analog Devices Inc.:](#)

[ADRF6801ACPZ-R7](#) [ADRF6801-EVALZ](#)