

AC Filter



See below:  
[Approvals and Compliances](#)

**Description**

- Line filter in standard and medical version
- 1-stage
- standard attenuation

**Characteristics**

- Designed for standard applications
- Protection against interference voltage from the mains  
Possible interferences generated in the equipment are strongly attenuated
- Universal line filter for standard applications
- Suitable for use in equipment according to IEC/UL 62368-1

**Other versions on request**

- Version with wire connection
- Version with varistor for overvoltage protection

**References**

Alternative: Standard version

**Weblinks**

[pdf data sheet](#), [html datasheet](#), [General Product Information](#), [Approvals](#), [Distributor-Stock-Check](#), [Detailed request for product](#), [Microsite](#)

**Technical Data**

Ratings IEC	1 - 10A @ Ta 40 °C / 250 VAC; 50Hz
Ratings UL/CSA	1 - 10A @ Ta 40 °C / 125 VAC; 60Hz
Leakage Current	standard < 0.25 mA (250V / 60Hz) medical (M5) < 5 µA resp. (M80) < 80 µA (250 V / 60 Hz)
Dielectric Strength	1.7 kVDC between L-N 2.7 kVDC between L/N-PE Test voltage (2 sec)
Allowable Operation Temperature	-25 °C to 100 °C
Climatic Category	25/100/21 acc. to IEC 60068-1
Protection Class	Suitable for appliances with protection class I acc. to IEC 61140
Terminal	Quick connect terminals 6.3 x 0.8 mm
Material: Housing	Nickel plated steel

Line Filter	Standard and Medical Version, IEC 60939, UL 1283, CSA C22.2 no. 8 <a href="#">Technical Details</a>
MTBF	> 200'000h acc. to MIL-HB-217 F

**Approvals and Compliances**



Detailed information on product approvals, code requirements, usage instructions and detailed test conditions can be looked up in [Details about Approvals](#)

SCHURTER products are designed for use in industrial environments. They have approvals from independent testing bodies according to national and international standards. Products with specific characteristics and requirements such as required in the automotive sector according to IATF 16949, medical technology according to ISO 13485 or in the aerospace industry can be offered exclusively with customer-specific, individual agreements by SCHURTER.

## Approvals



The approval mark is used by the testing authorities to certify compliance with the safety requirements placed on electronic products.

Approval Reference Type: FMW2

Approval Logo	Certificates	Certification Body	Description
	VDE Approvals	VDE	Certificate Number: 40004673
	UL Approvals	UL	UL File Number: E72928



## Product standards

Product standards that are referenced

Organization	Design	Standard	Description
	Designed according to	IEC 60939	Passive filters for suppressing electromagnetic interference
	Designed according to	UL 1283	Electromagnetic interference filters
	Designed according to	CSA C22.2 no. 8	Electromagnetic interference (EMI) filters





## Application standards

Application standards where the product can be used

Organization	Design	Standard	Description
	Designed for applications acc.	IEC/UL 62368-1	IEC 62368-1 includes the basic requirements for safety of audio, video, information technology and office equipment.
	Designed for applications acc.	IEC 60601-1	Medical electrical equipment - Part 1: General requirements for basic safety and essential performance

## Compliances

The product complies with following Guide Lines

Identification	Details	Initiator	Description
	CE declaration of conformity	SCHURTER AG	The CE marking declares that the product complies with the applicable requirements laid down in the harmonisation of Community legislation on its affixing in accordance with EU Regulation 765/2008.
	RoHS	SCHURTER AG	Directive RoHS 2011/65/EU, Amendment (EU) 2015/863
	China RoHS	SCHURTER AG	The law SJ / T 11363-2006 (China RoHS) has been in force since 1 March 2007. It is similar to the EU directive RoHS.
	REACH	SCHURTER AG	On 1 June 2007, Regulation (EC) No 1907/2006 on the Registration, Evaluation, Authorization and Restriction of Chemicals 1 (abbreviated as "REACH") entered into force.
	Medical Equipment	SCHURTER AG	Suitable for use in medical equipment according to IEC/UL 60601-1

## Dimension [mm]

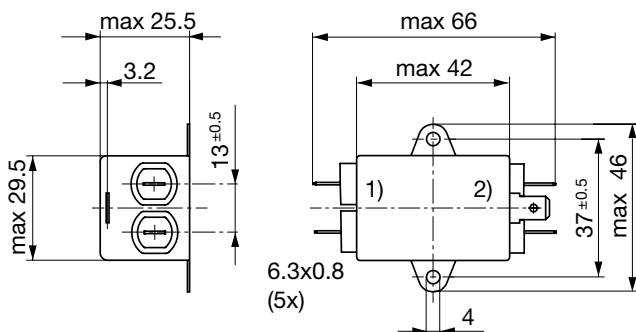

Diagrams

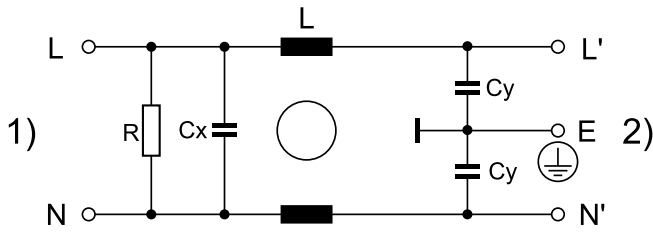

R and Cy according to version, see variants  
 1) Line, 2) Load

Attenuation Loss

----- 50Ω differential mode \_\_\_\_\_ 50Ω common mode

Standard version

1 A

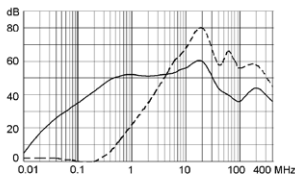

3 A

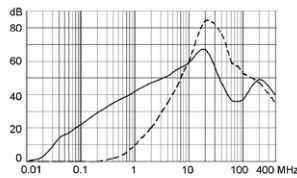

6 A

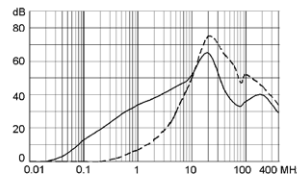

10 A

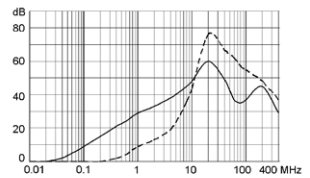

Medical version (M5)

1 A

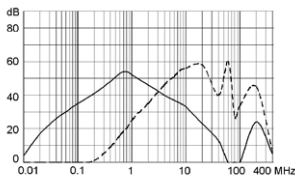

3 A

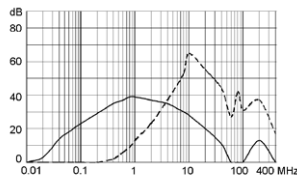

6 A

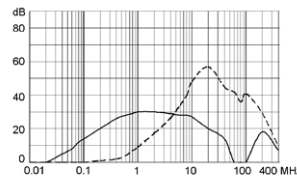

10 A

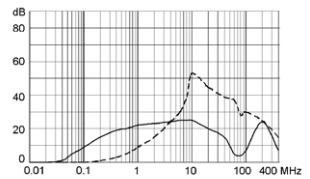

Medical version (M80)

1 A

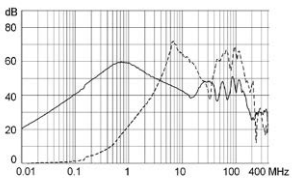

3 A

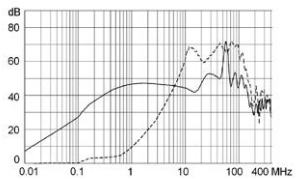

6 A

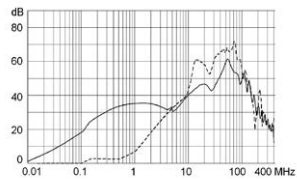

10 A

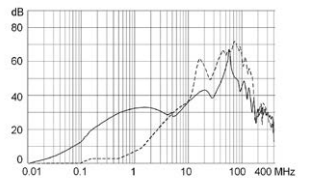

All Variants

Rated Current [A]	Filter-Type	Leakage Current [mA]	L [mH]	Cx [nF]	Cy [nF]	R [MΩ]	Weight [g]	Order Number
1	Standard version	0.25	2 x 10	15	2.2	-	55g	5500.2039
3	Standard version	0.25	2 x 2	15	2.2	-	55g	5500.2040
6	Standard version	0.25	2 x 0.8	15	2.2	-	55g	5500.2041
10	Standard version	0.25	2 x 0.4	15	2.2	-	55g	5500.2042
1	Medical Version (M5)	0.005	2 x 10	15	-	1	55g	5500.2098
3	Medical Version (M5)	0.005	2 x 2	15	-	1	55g	5500.2104
6	Medical Version (M5)	0.005	2 x 0.8	15	-	1	55g	5500.2100
10	Medical Version (M5)	0.005	2 x 0.4	15	-	1	55g	5500.2102
1	Medical Version (M80)	0.08	2 x 10	15	0.47	1	55g	5500.2099

Rated Current [A]	Filter-Type	Leakage Current [mA]	L [mH]	Cx [nF]	Cy [nF]	R [MΩ]	Weight [g]	Order Number
3	Medical Version (M80)	0.08	2 x 2	15	0.47	1	55 g	<a href="#">5500.2105</a>
6	Medical Version (M80)	0.08	2 x 0.8	15	0.47	1	55 g	<a href="#">5500.2101</a>
10	Medical Version (M80)	0.08	2 x 0.4	15	0.47	1	55 g	<a href="#">5500.2103</a>

Most Popular.

Availability for all products can be searched real-time: <https://www.schurter.com/en/Stock-Check/Stock-Check-SCHURTER>

**Packaging unit** 25 Pcs

# Mouser Electronics

Authorized Distributor

Click to View Pricing, Inventory, Delivery & Lifecycle Information:

## Schurter:

[5500.2101](#) [5500.2100](#) [5500.2104](#) [5500.2105](#) [5500.2102](#) [5500.2103](#) [5500.2040](#) [5500.2042](#) [5500.2041](#) [5500.2039](#)  
[5500.2099](#) [5500.2098](#)