

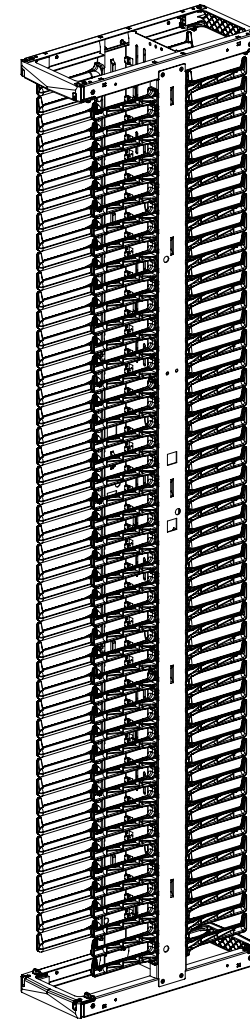

THIS COPY IS PROVIDED ON A RESTRICTED BASIS AND IS NOT TO BE USED IN ANY WAY DETRIMENTAL TO THE INTERESTS OF PANDUIT CORP.

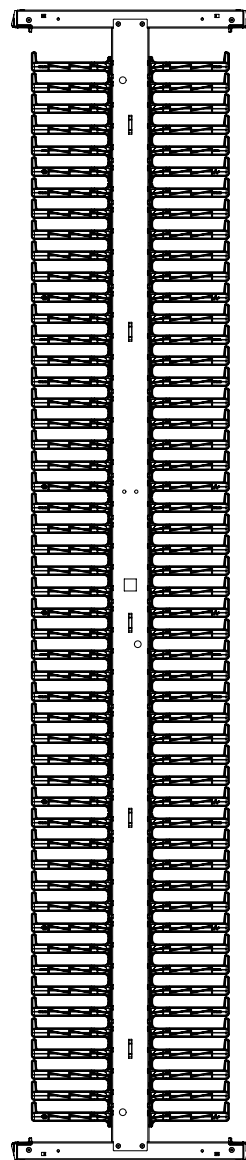
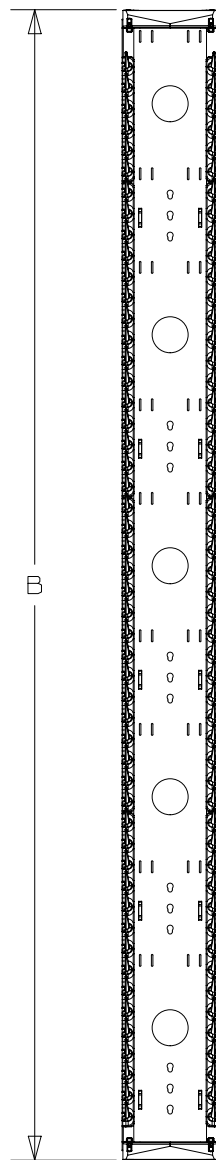
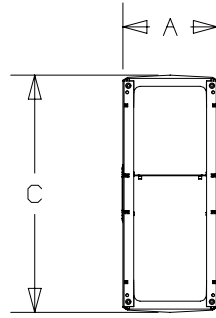

NOTES:

1. VISIT OUR ON-LINE CATALOG AT WWW.PANDUIT.COM FOR A LIST OF CURRENT PARTS APPLICABLE FOR USE WITH THIS PRODUCT.
2. DIMENSIONS IN [] ARE METRIC.
3. WEIGHT: SEE TABLE ON PAGE 3
4. PART INCLUDES:
 - 1- PATCHRUNNER 2 VERTICAL MANAGER, FRONT AND REAR FINGERS
 - 1- HARDWARE KIT
5. CAN BE USED WITH ANY 19 OR 23 INCH EIA STANDARD RACK
6. ALL DIMENSIONS ARE REFERENCE ONLY.

REV	DATE	BY	CHK	APR	DESCRIPTION	ECN
00B	4-17-18	BJN	JCO	JEFK	ADDED ** TO ALL 96" (8FT) PART NUMBERS	14V455MX-DC
00A	12-13-17	TWV	JCO	JEFK	RELEASED TO PRODUCTION	14V455MX-DC

PART NUMBER		PR2V**	
INSPECTION INSTRUCTION NUMBER		FMEA & CONTROL PLAN NUMBER	
TITLE			
PATCHRUNNER 2 VERTICAL CABLE MANAGER FRONT AND REAR FINGERS CUSTOMER DRAWING			
ITEM REVISION NAME		14V455MX/00	
DATASET FILE NAME		14V455MX_DC/00B	
UNLESS OTHERWISE SPECIFIED, DIMENSIONAL TOLERANCES ARE: IN [mm]		 MATERIAL: BACKBONE: STEEL FINGERS: ABS HINGE LATCHES: POLYCARBONATE	
DRAWN BY		THIRD ANGLE PROJECTION	
DATE		DRAWING NUMBER:	
12-13-17		14V455MX-DC	
CHK		SCALE	
JCO		NONE	
SHT 1 OF 3		SIZE	
		B	

D10100DB/17

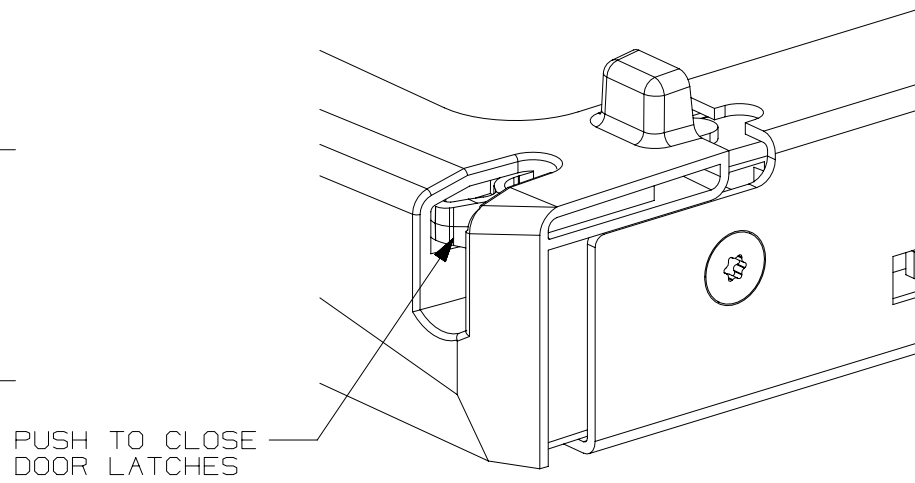
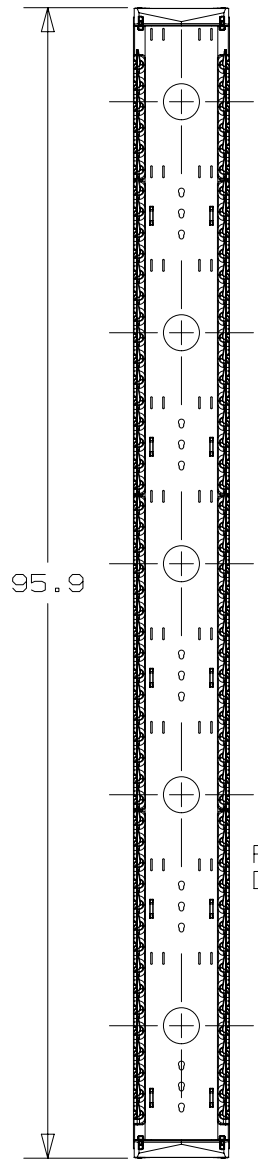
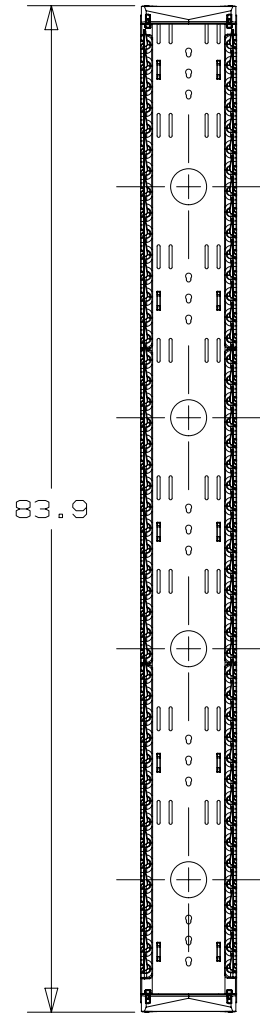

DETAIL A
SCALE 1:1

INTEGRATED DOOR BRACKETS

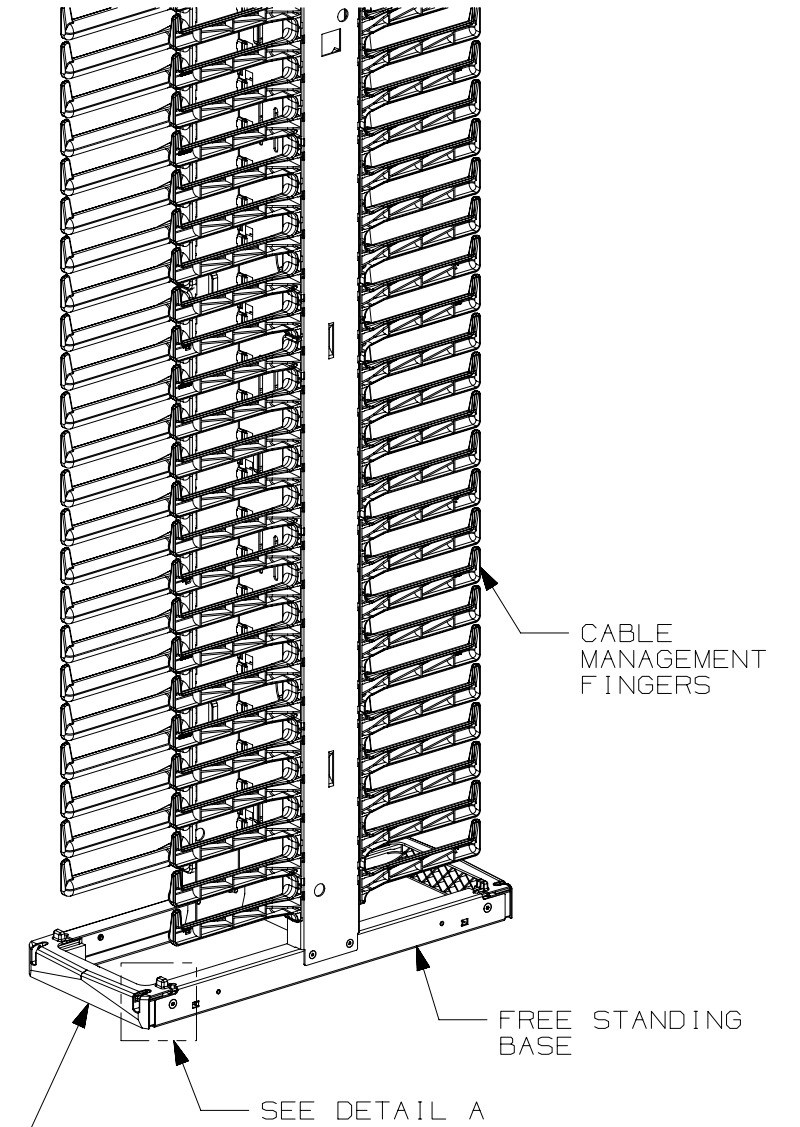

REV	DATE	BY	CHK	APR	DESCRIPTION	ECN
00B	4-17-18	BJN	JCO	JFK	SEE SHEET 1 FOR REVISION HISTORY	14V455MX-DC
00A	12-13-17	TWV	JCO	JFK	SEE SHEET 1 FOR REVISION HISTORY	14V455MX-DC

PART NUMBER		PR2V**	
TITLE			
PATCHRUNNER 2 VERTICAL CABLE MANAGER FRONT AND REAR FINGERS			
CUSTOMER DRAWING			
ITEM REVISION NAME		14V455MX/00	
DATASET FILE NAME		14V455MX_DC/00B	
UNLESS OTHERWISE SPECIFIED, DIMENSIONAL TOLERANCES ARE: IN [mm]			PANDUIT MATERIAL: BACKBONE: STEEL FINGERS: ABS HINGE LATCHES: POLYCARBONATE
THIRD ANGLE PROJECTION			
DRAWN BY	DATE	CHK	SCALE
TWV	12-13-17	JCO	NONE
DRAWING NUMBER:			14V455MX-DC
SHT 2 OF 3			SIZE B

D10100DB/17

PART NO.	DESCRIPTION	A=OVERALL WIDTH		B=OVERALL HEIGHT		C=OVERALL DEPTH		MANAGER AND DOOR FULLY UNPACKED WEIGHT	MANAGER AND DOOR SHIPPING WEIGHT
		INCHES	MM	INCHES	MM	INCHES	MM		
PR2V06**	PATCHRUNNER 2 VERTICAL MANAGER 6in WIDE, 7ft TALL, FRONT AND REAR	6.00	152.4	83.88	2130.4	19.8	502.9	34.27 LBS EACH [15.5 KG EACH]	36.27 LBS EACH [16.45 KG EACH]
PR2V08**	PATCHRUNNER 2 VERTICAL MANAGER 8in WIDE, 7ft TALL, FRONT AND REAR	8.00	203.2	83.88	2130.4	19.8	502.9	37.42 LBS EACH [17 KG EACH]	39.42 LBS EACH [17.88 KG EACH]
PR2V10**	PATCHRUNNER 2 VERTICAL MANAGER 10in WIDE, 7ft TALL, FRONT AND REAR	10.00	254.0	83.88	2130.4	19.8	502.9	40.61 LBS EACH [18.4 KG EACH]	42.61 LBS EACH [19.3 KG EACH]
PR2V12**	PATCHRUNNER 2 VERTICAL MANAGER 12in WIDE, 7ft TALL, FRONT AND REAR	12.00	304.8	83.88	2130.4	19.8	502.9	43.75 LBS EACH [19.8 KG EACH]	45.75 LBS EACH [20.75 KG EACH]
PR2V0696**	PATCHRUNNER 2 VERTICAL MANAGER 6in WIDE, 8ft TALL, FRONT AND REAR	6.00	152.4	95.88	2435.2	19.8	502.9	38.27 LBS EACH [17.4 KG EACH]	40.27 LBS EACH [18.3 KG EACH]
PR2V0896**	PATCHRUNNER 2 VERTICAL MANAGER 8in WIDE, 8ft TALL, FRONT AND REAR	8.00	203.2	95.88	2435.2	19.8	502.9	41.86 LBS EACH [19 KG EACH]	43.86 LBS EACH [19.9 KG EACH]
PR2V1096**	PATCHRUNNER 2 VERTICAL MANAGER 10in WIDE, 8ft TALL, FRONT AND REAR	10.00	254.0	95.88	2435.2	19.8	502.9	45.48 LBS EACH [20.6 KG EACH]	47.48 LBS EACH [21.5 KG EACH]
PR2V1296**	PATCHRUNNER 2 VERTICAL MANAGER 12in WIDE, 8ft TALL, FRONT AND REAR	12.00	304.8	95.88	2435.2	19.8	502.9	49.06 LBS EACH [22.3 KG EACH]	51.06 LBS EACH [23.2 KG EACH]
PR2V0679	PATCHRUNNER 2 VERTICAL MANAGER 6in WIDE, 6.5ft TALL, FRONT AND REAR	6.00	152.4	78.88	2003.4	19.8	502.9	32.45 LBS EACH [14.7 KG EACH]	34.45 LBS EACH [15.63 KG EACH]
PR2V1279	PATCHRUNNER 2 VERTICAL MANAGER 12in WIDE, 6.5ft TALL, FRONT AND REAR	12.00	304.8	78.88	2003.4	19.8	502.9	41.39 LBS EACH [18.8 KG EACH]	43.39 LBS EACH [19.68 KG EACH]

**DENOTES COLOR
NONE=BLACK
WH=WHITE

REV	DATE	BY	CHK	APR	DESCRIPTION	ECN
00B	4-17-18	BJN	JCO	JFK	SEE SHEET 1 FOR REVISION HISTORY	14V455MX-DC
00A	12-13-17	TWV	JCO	JFK	SEE SHEET 1 FOR REVISION HISTORY	14V455MX-DC

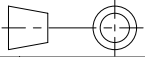
PART NUMBER		PR2V**	
TITLE			
PATCHRUNNER 2 VERTICAL CABLE MANAGER FRONT AND REAR FINGERS CUSTOMER DRAWING			
ITEM REVISION NAME		14V455MX/00	
DATASET FILE NAME		14V455MX_DC/00B	
UNLESS OTHERWISE SPECIFIED, DIMENSIONAL TOLERANCES ARE: IN [mm]			
DRAWN BY		DATE	
TWW		12-13-17	
CHK		SCALE	
JCO		NONE	
MATERIAL:		DRAWING NUMBER:	
BACKBONE: STEEL FINGERS: ABS HINGE LATCHES: POLYCARBONATE		14V455MX-DC	
THIRD ANGLE PROJECTION		SIZE	
		SHT 3 OF 3	

D10.100DB/17