

Enhanced RS-232 Line Drivers/Receivers

FEATURES

- Operates from a Single +5V Power Supply
- Meets all RS-232F and ITU V.28 Specifications
- Operates with 0.1 μ F Ceramic Capacitors
- High Data rate - 120kbps under load
- Low power CMOS Operation
- +/-2kV Human Body Model ESD Protection
- Lead Free packaging available

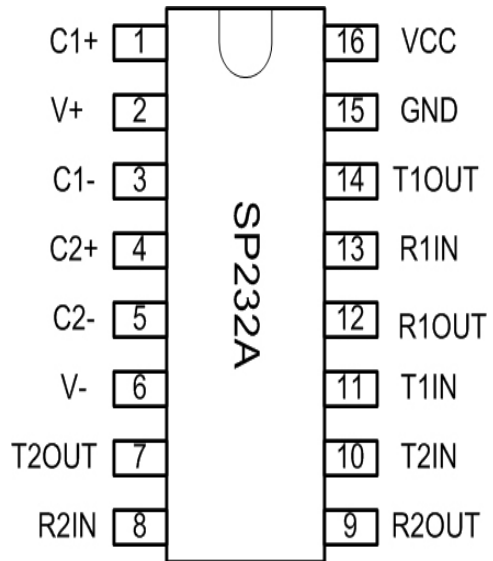

DESCRIPTION

The SP232A is a line driver and receiver pair that meets the specifications of RS-232 and V.28 serial protocols. This device is pin-to-pin compatible with popular industry standard pinouts. The SP232A offers 120kbps data rate under load, small ceramic type 0.1 μ F charge pump capacitors and overall ruggedness for commercial applications. The SP232A features Exar's BiCMOS design allowing for low power operation without sacrificing performance. This device is available in plastic DIP, SOICW and nSOIC packages operating over the commercial and industrial temperature ranges.

SOICW and nSOIC versions available, PDIP versions are obsolete.

ABSOLUTE MAXIMUM RATINGS

These are stress ratings only and functional operation of the device at these ratings or any other above those indicated in the operation sections of the specifications below are not implied. Exposure to absolute maximum ratings conditions for extended periods of time may affect reliability.

Supply Voltage (V_{CC}).....+ 6V
 $V+$ ($V_{CC}-0.3V$) to +11.0V
 $V-$-11.0V
 Input Voltages
 T_{in}-0.3V to ($V_{CC} + 0.3V$)
 R_{in} +/-15V
 Output Voltages
 T_{out}($V+$, +0.3V) to ($V-$, -0.3V)
 R_{out}-0.3V to ($V_{CC} + 0.3V$)

Short Circuit duration
 T_{out}Continuous
 Package Power Dissipation:
 Plastic DIP.....375mW
 (derate 7mW/°C above +70°C)
 Small Outline.....375mW
 (derate 7mW/°C above +70°C)
 Storage Temperature.....-65°C to +150°C
 Lead Temperature (soldering, 10s)..... +300°C

ELECTRICAL CHARACTERISTICS

$V_{CC}=5V \pm 10\%$, 0.1 μF charge pump capacitors, T_{MIN} to T_{MAX} , unless otherwise noted, Typical values are $V_{CC}=5V$ and $T_A=25^\circ C$

PARAMETER	TEST CONDITIONS	MIN	TYP	MAX	UNIT
TTL INPUT					
Logic Threshold LOW	T_{IN}			0.8	Volts
Logic Threshold HIGH	T_{IN}	2.0			Volts
Logic Pull-Up Current	$T_{IN} = 0V$		15	200	μA
TTL OUTPUT					
Output Voltage LOW	$I_{OUT} = 3.2 \text{ mA}; V_{CC} = +5V$			0.4	Volts
Output Voltage HIGH	$I_{OUT} = -1.0 \text{ mA}$	3.5			Volts
RS-232 OUTPUT					
Output Voltage Swing	All Transmitter outputs loaded with 3k ohms to GND	+/-5.0	+/-6.5V		Volts
Output Resistance	$V_{CC} = 0V, V_{out} = +/-2V$	300			Ohms
Output Short Circuit Current	Infinite Duration		+/-18		mA
Maximum Data Rate	$CL = 2500pF, RL = 3k\Omega$	120	240		kbps
RS-232 INPUT					
Voltage Range		-15		+15	Volts
Voltage Threshold LOW	$V_{CC} = 5V, T_A=25^\circ C$	0.8	1.2		Volts
Voltage Threshold HIGH	$V_{CC} = 5V, T_A=25^\circ C$		1.7	2.4	Volts
Hysteresis	$V_{CC} = 5V, T_A=25^\circ C$	0.2	0.5	1.0	Volts
Resistance	$T_A=25^\circ C, -15V \leq V_{IN} \leq +15V$	3	5	7	k Ω

ELECTRICAL CHARACTERISTICS

V_{CC}=5V ±10%, 0.1µF charge pump capacitors, T_{MIN} to T_{MAX}, unless otherwise noted, Typical values are V_{CC}=5V and T_A=25°C

DYNAMIC CHARACTERISTICS					
Driver Propagation Delay	TTL to RS_232; CL = 50pF		1.5	3.0	µs
Receiver Propagation Delay	RS-232 to TTL,		0.1	1.0	µs
Instantaneous Slew Rate	CL = 10pF, RL = 3-7kΩ			30	V/ µs
Transition Region Slew Rate	CL = 2500pF, RL = 3kΩ; Measured from +3V to -3V or -3V to +3V		10		V/ µs
POWER REQUIREMENTS					
V _{CC} Power Supply Current	No Load, V _{CC} = 5V, T _A =25°C		1.5	5	mA
V _{CC} Power Supply Current, Loaded	All Transmitters RL = 3kΩ, T _A =25°C		11		mA

PIN ASSIGNMENTS

Pin Number	Pin Name	Pin Function
1	C1+	Positive terminal of the voltage doubler charge pump capacitor
2	V+	+6.5V generated by the charge pump
3	C1-	Negative terminal of the voltage doubler charge pump capacitor
4	C2+	Positive terminal of the inverting charge pump capacitor
5	C2-	Negative terminal of the inverting charge pump capacitor
6	V-	-6.7V generated by the charge pump
7	T2OUT	RS-232 driver output
8	R2IN	RS-232 receiver input
9	R2OUT	TTL/CMOS receiver output
10	T2IN	TTL/CMOS driver input
11	T1IN	TTL/CMOS driver input
12	R1OUT	TTL/CMOS receiver output
13	R1IN	RS-232 receiver input
14	T1OUT	RS-232 driver output
15	GND	Ground
16	V _{CC}	5V supply voltage

DETAILED DESCRIPTION

The SP232A transceiver is a two driver and two receiver device that meets the EIA/TIA-232 and V.28 serial communication protocol. The device is pin-to-pin compatible with popular industry standard pinouts. The SP232A offers 120kbps data rate, 10V/ μ s slew rate and a regulated charge pump that operates from a single 5V supply. The proprietary on-board charge pump generates a regulated output of \pm 6.5V for RS-232 compliant voltage levels.

Theory Of Operation

The SP232A is made up of three basic circuit blocks: 1. Driver, 2. Receiver, and 3. charge pump.

Drivers

The drivers are inverting level transmitters that convert TTL or CMOS logic levels to EIA/TIA-232 levels with an inverted sense relative to the input logic levels. Typically, the RS-232 output voltage swing is \pm 6.5V with no load and \pm 5.0V minimum when fully loaded. The driver outputs are protected against infinite short-circuits to ground without degradation in reliability.

The drivers can guarantee output data rates of 120Kbps under worst case loading of 3k ohms and 2500pF.

The driver output Slew Rate is internally limited to 30V/ μ s in order to meet the EIA standards (EIA-232F). Additionally, the driver output LOW to HIGH transition meet the monotonicity output requirements of the standard.

Receivers

The receivers convert EIA/TIA-232 signal levels to TTL or CMOS logic output levels. Since the input is usually from a transmission line, where long cable length and system interference can degrade the signal, the receiver inputs have a typical hysteresis margin of 500mV. This ensures that the receiver is virtually immune to noisy transmission lines. Should an input be left unconnected, an internal 5Kohm pull-down resistor to ground will commit the output of the receiver to a logic HIGH state. The input voltage range for the SP232A Receiver is \pm 15V.

Charge pump

The charge pump is a patented design and uses a unique approach compared to older less efficient designs. The charge pump requires 4 external capacitors and uses a four phase voltage shifting technique. The internal power supply consists of a regulated dual charge pump that provides output voltages of \pm 6.5V. This is important to maintain compliant RS-232 levels regardless of power supply fluctuations. The charge pump operates in a discontinuous mode using an internal oscillator. If the voltages are less than a magnitude of 6.5V, the charge pump is enabled. If the output voltage exceed a magnitude of 6.5V then the charge pump is disabled. The internal oscillator controls the four phases of the voltage shifting. A description of each phase follows:

Phase 1

Vss charge store and double: The positive terminals of capacitors C1 and C2 are charged from Vcc with their negative terminals initially connected to ground. C1+ is then connected to ground and the stored charge from C1- is superimposed onto C2-. Since C2+ is still connected to Vcc the voltage potential across C2 is now 2 x Vcc.

Phase 2

Vss transfer and invert: Phase two connects the negative terminal of C2 to the Vss storage capacitor and the positive terminal of C2 to ground. This transfers the doubled and inverted (V-) voltage onto C4. Meanwhile, capacitor C1 is charged from Vcc in order to prepare it for its next phase.

Phase 3

Vdd charge store and double: Phase three is identical to the first phase. The positive terminals of C1 and C2 are charged from Vcc with their negative terminals initially connected to ground. C1+ is then connected to ground and the stored charge from C1- is superimposed onto C2-. Since C2+ is still connected to Vcc the voltage potential across capacitor C2 is now 2 x Vcc.

Phase 4

V_{DD} transfer. The fourth phase connects the negative terminal of C₂ to ground and the positive terminal of C₂ to the V_{DD} storage capacitor. This transfers the doubled (V₊) voltage onto C₃. Meanwhile, capacitor C₁ is charged from V_{CC} to prepare it for its next phase.

Under lightly loaded conditions, the intelligent pump oscillator maximizes efficiency by running only as needed to maintain V₊ and V₋ voltage levels. Since interface transceivers spend most of their time at idle, this power-efficient innovation can greatly reduce total power consumption. This improvement is made possible by the independent phase sequences of the Exar charge pump design.

The clock rate of the charge pump typically operates greater than 70kHz allowing the pump to operate efficiently with small 0.1µF capacitors. Efficient operation depends on rapid charging and discharging of C₁ and C₂. Therefore, the capacitors should be mounted as close as possible to the IC and have a low ESR (equivalent series resistance). Inexpensive, surface mount ceramic capacitors are ideal for use on charge pump. If polarized capacitors are used the positive and negative terminals should be connected as shown on the typical operating circuit. A diagram of the 4 individual phases is shown in Figure 1.

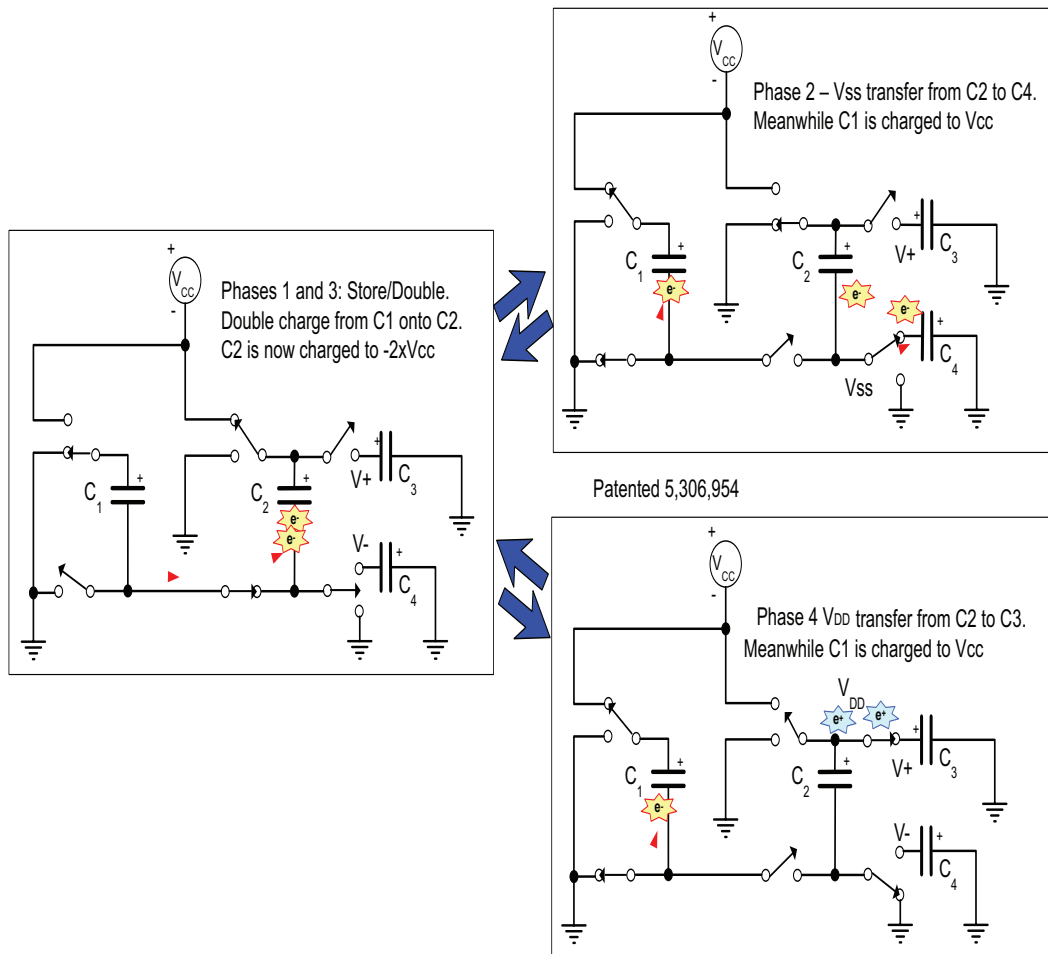

Figure 1. Charge pump phases

TYPICAL PERFORMANCE CHARACTERISTICS

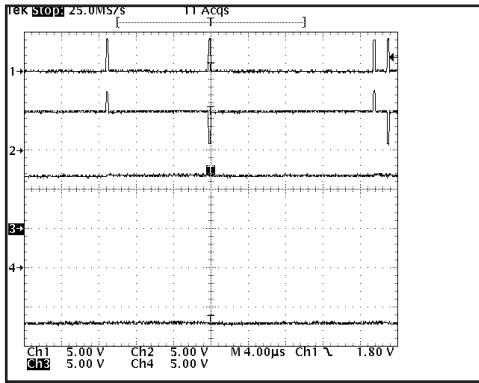

Figure 2, Charge pump waveforms with no load (1 = C1+, 2 = C2+, 3 = V+, 4 = V-).

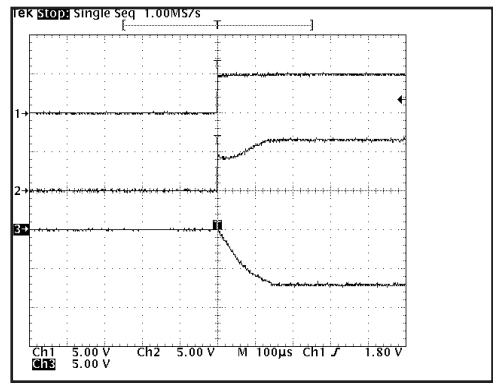

Figure 5, Charge pump outputs at start up (1 = Vcc, 2 = V+, 3 = V-).

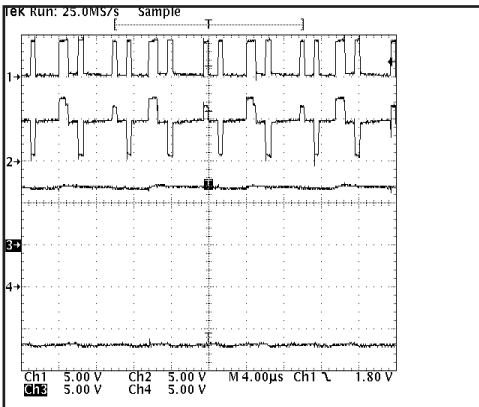

Figure 3, Charge pump waveforms when fully loaded with 3k ohms (1 = C1+, 2 = C2+, 3 = V+, 4 = V-).

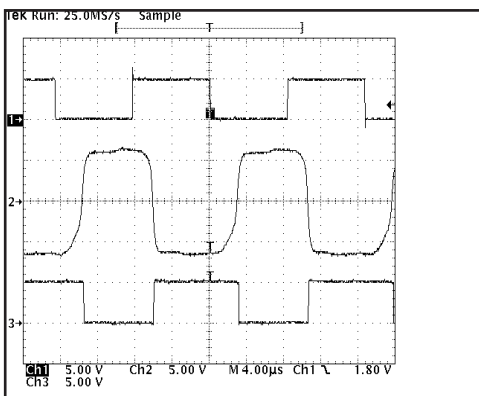

Figure 4, Loopback results at 60kHz and 2500pF load (1 = TXin, 2 = TXout/RXin, 3 = RXout).

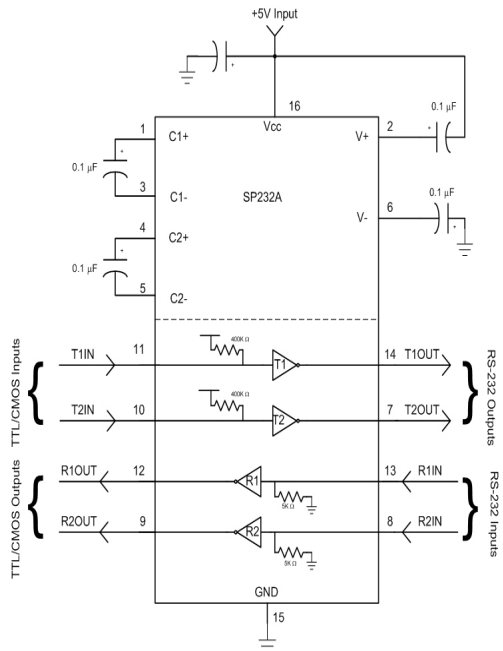
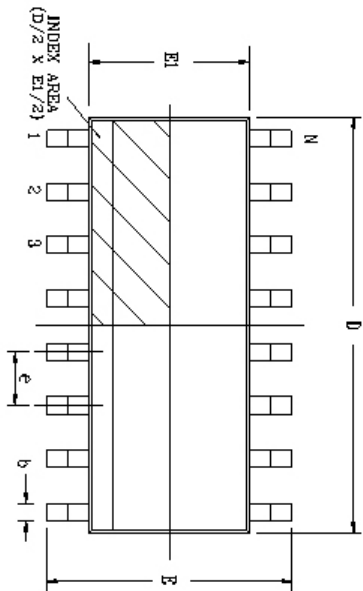
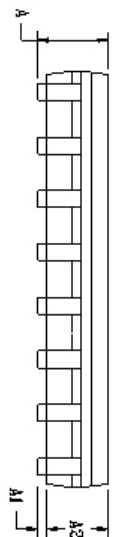

Figure 6, Typical Application circuit

REVISION HISTORY			
REV.	DESCRIPTION	DATE	APP'D.
A	DRAWING ORIGINATOR	10/12/05	JL
B	ISSUING FORMAT MODIFICATION	07/19/06	JL
C	CHANGE DRAWING LOGO AND COMPANY NAME	11/21/07	JL



Top View



Side View

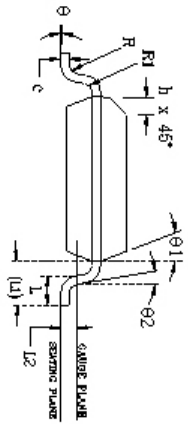

Front View

16 Pin SOICN		JEDEC MS-012		Variation A/C	
SYMBOLS	DIMENSIONS IN MM (Control Unit)		DIMENSIONS IN INCH (Reference Unit)		
	MIN	MAX	MIN	MAX	
A	1.35	1.75	0.053	0.069	
A1	0.10	0.25	0.004	0.010	
A2	1.25	1.55	0.049	0.065	
b	0.31	0.51	0.012	0.020	
c	0.17	0.25	0.007	0.010	
E	6.00	BSC	0.236	BSC	
E1	3.90	BSC	0.154	BSC	
e	1.27	BSC	0.050	BSC	
h	0.25	0.50	0.010	0.020	
L	0.40	1.27	0.016	0.050	
L1	1.04	REF	0.041	REF	
L2	0.25	BSC	0.010	BSC	
R	0.07	0.003	0.003	—	
P1	0.07	0.003	0.003	—	
phi	0°	8°	0°	8°	
phi1	5°	15°	5°	15°	
phi2	0°	—	0°	—	
D	9.90	BSC	0.390	BSC	
N	16		16		

		EXAR CORPORATION	
Packaging Approval:	Drawing No.:	Revision:	Sheet:
Br: JL	Date: 11/21/07	C	1 OF 1

16 pin PDIP versions are obsolete.

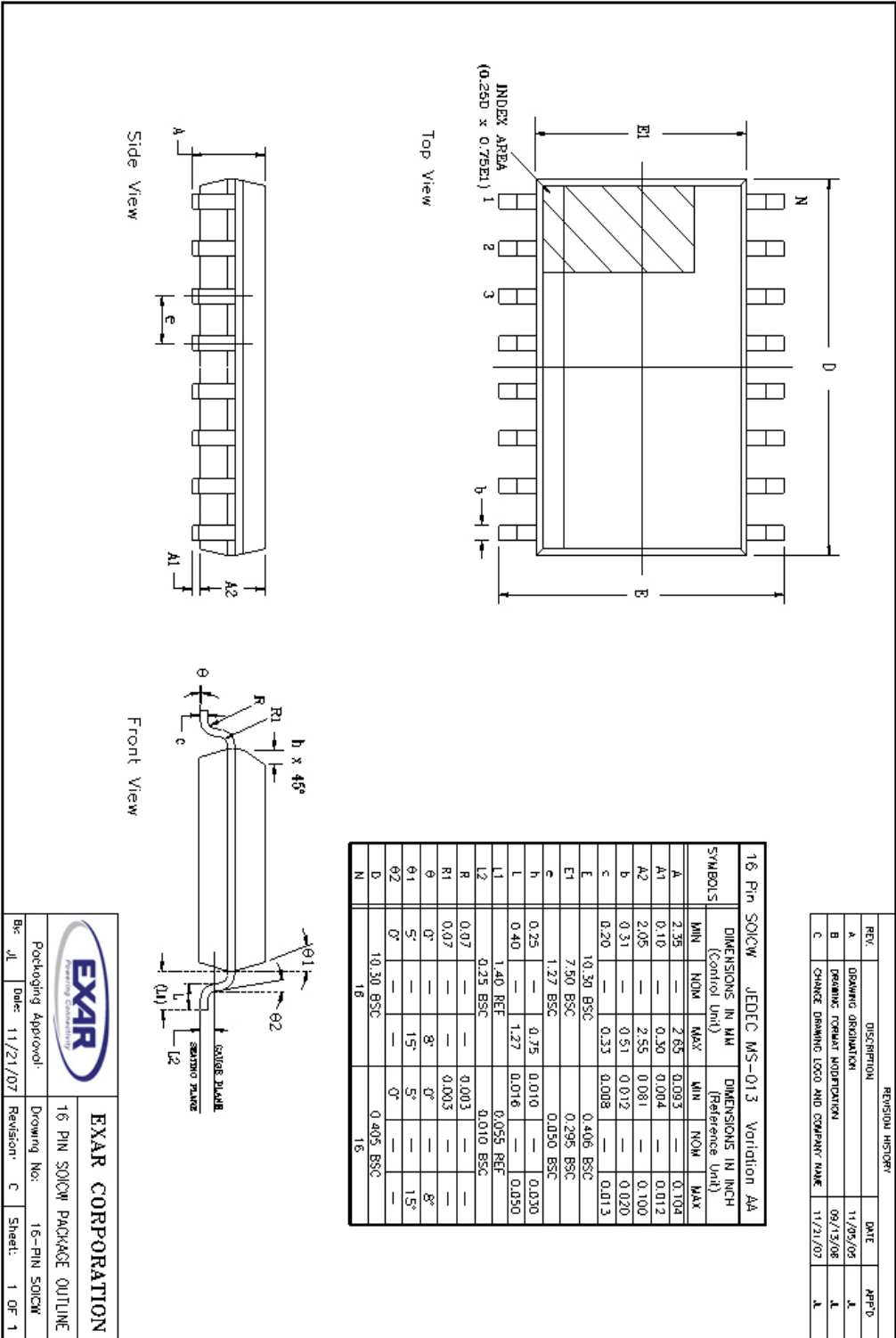

REVISION HISTORY			
REV.	DESCRIPTION	DATE	APP'D.
A	DRAWING ORGANIZATION	11/05/04	JL
B	DRAWING FORMAT MODIFICATION	09/13/08	JL
C	CHANGE DRAWING LOGO AND COMPANY NAME	11/21/07	JL

EXAR CORPORATION
EXAR CORPORATION

16 PIN SOICW PACKAGE OUTLINE

Packaging Approved: Drawing No: 16-PIN SOICW
 Rev. JL Date: 11/21/07 Revision: C Sheet: 1 OF 1

REMARKS:
FOR BLD AND 16LD
ALL END LEADS (4X)
ARE HALF LEAD TYPES

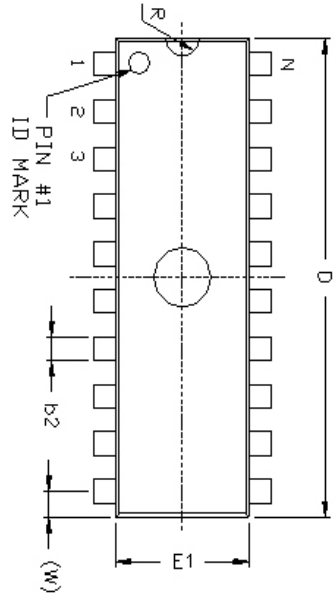

Top View

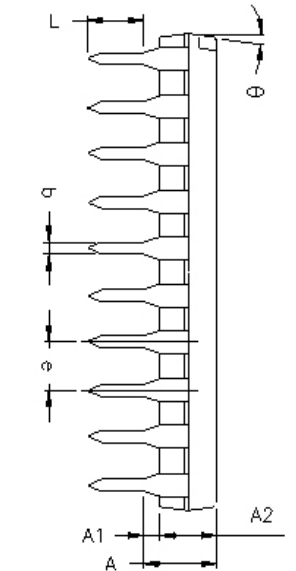
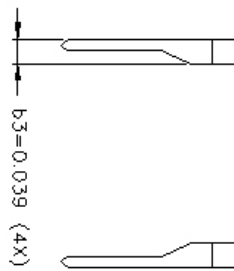

Side View

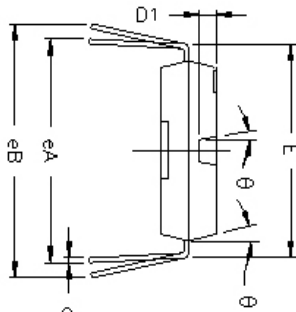

Front View

REVISION HISTORY			
REV.	DISPOSITION	DATE	APP'D
A	DRAWING MODIFICATION	11/21/05	JL
B	DRAWING FORAM MODIFICATION	04/28/06	JL
C	CHANGE DRAWING LOGO AND COMPANY NAME	11/21/07	JL

SYMBOLS	16 Pin PDIP JEDEC MS-001 Variation BB			DIMENSIONS IN INCH (Control Unit)			DIMENSIONS IN MM (Reference Unit)		
	MIN	NOM	MAX	MIN	NOM	MAX	MIN	NOM	MAX
A	—	0.210	—	—	—	5.33	—	—	—
A1	0.015	—	0.38	—	—	—	—	—	—
A2	0.115	0.130	0.195	2.92	3.30	4.95	—	—	—
b	0.014	0.018	0.022	0.36	0.46	0.56	—	—	—
b2	0.045	0.060	0.070	1.14	1.52	1.78	—	—	—
c	0.008	0.010	0.014	0.20	0.25	0.36	—	—	—
D1	0.030	—	0.060	0.76	—	1.52	—	—	—
E	0.100	0.310	0.325	7.62	7.87	8.26	—	—	—
E1	0.240	0.250	0.280	6.10	6.35	7.11	—	—	—
e	0.100	BSC	—	2.54	BSC	—	—	—	—
ea	0.300	BSC	—	7.62	BSC	—	—	—	—
eB	—	0.430	—	—	10.92	—	—	—	—
L	0.115	0.130	0.150	2.92	3.30	3.81	—	—	—
W	0.075	REF	—	1.91	REF	—	—	—	—
R	0.030	BSC	—	0.76	BSC	—	—	—	—
θ	4°	7°	10°	4°	7°	10°	—	—	—
D	0.735	0.755	0.775	18.67	19.18	19.69	—	—	—
N	—	16	—	—	16	—	—	—	—

		EXAR CORPORATION Packaging Approved:	
By: JL	Date: 11/21/07	Revision: C	Sheet: 1 OF 1

Part Number	Temperature Range	Package	Packaging Method	Lead-Free ⁽²⁾
SP232ACN-L	0°C to +70°C	16 pin nSOIC	Tube	Yes
SP232ACN-L/TR	0°C to +70°C	16 pin nSOIC	Tape and Reel	Yes
SP232ACT-L/TR	0°C to +70°C	16 pin WSOIC	Tape and Reel	Yes
SP232AEN-L	-40°C to +85°C	16 pin nSOIC	Tube	Yes
SP232AEN-L/TR	-40°C to +85°C	16 pin nSOIC	Tape and Reel	Yes

NOTES:

1. Refer to www.maxlinear.com/SP232A for most up-to-date Ordering Information.
2. Visit www.maxlinear.com for additional information on Environmental Rating.
3. 16 pin PDIP versions are obsolete.

REVISION HISTORY		
Date	Revision	Description
1-31-07	Jan 31-07	Original SP232A/233A/310A/312A data sheet
5-13-08	100	Generate individual SP232A datasheet using Exar format, update elect. spec. (TXout) and theory of operation to reflect new Charge Pump design as a result of 5 um to 2um conversion, remove EOL devices from ordering info and update new performance figures.
3-24-20	101	Update to MaxLinear logo. Update Ordering Information. Add revision history.



MaxLinear, Inc.
 5966 La Place Court, Suite 100
 Carlsbad, CA 92008
 760.692.0711 p.
 760.444.8598 f.
www.maxlinear.com

The content of this document is furnished for informational use only, is subject to change without notice, and should not be construed as a commitment by MaxLinear, Inc. MaxLinear, Inc. assumes no responsibility or liability for any errors or inaccuracies that may appear in the informational content contained in this guide. Complying with all applicable copyright laws is the responsibility of the user. Without limiting the rights under copyright, no part of this document may be reproduced into, stored in, or introduced into a retrieval system, or transmitted in any form or by any means (electronic, mechanical, photocopying, recording, or otherwise), or for any purpose, without the express written permission of MaxLinear, Inc.

MaxLinear, Inc. does not recommend the use of any of its products in life support applications where the failure or malfunction of the product can reasonably be expected to cause failure of the life support system or to significantly affect its safety or effectiveness. Products are not authorized for use in such applications unless MaxLinear, Inc. receives, in writing, assurances to its satisfaction that: (a) the risk of injury or damage has been minimized; (b) the user assumes all such risks; (c) potential liability of MaxLinear, Inc. is adequately protected under the circumstances.

MaxLinear, Inc. may have patents, patent applications, trademarks, copyrights, or other intellectual property rights covering subject matter in this document. Except as expressly provided in any written license agreement from MaxLinear, Inc., the furnishing of this document does not give you any license to these patents, trademarks, copyrights, or other intellectual property.

MaxLinear, the MaxLinear logo, and any MaxLinear trademarks, MxL, Full-Spectrum Capture, FSC, G.now, AirPHY and the MaxLinear logo are all on the products sold, are all trademarks of MaxLinear, Inc. or one of MaxLinear's subsidiaries in the U.S.A. and other countries. All rights reserved. Other company trademarks and product names appearing herein are the property of their respective owners.