

TRENCHSTOP™ 5 high speed soft switching IGBT co-packed with full current rated RAPID 1 fast and soft antiparallel diode

Features

- $V_{CE} = 650\text{ V}$
- $I_C = 30\text{ A}$
- High speed smooth switching device for hard & soft switching
- Very low V_{CEsat} , 1.35 V at nominal current
- 650 V breakdown voltage
- Low gate charge Q_G
- IGBT co-packed with full rated current RAPID 1 fast antiparallel diode
- Maximum junction temperature $T_{vjmax} = 175^\circ\text{C}$
- Pb-free lead plating; RoHS compliant
- Complete product spectrum and PSpice Models: <http://www.infineon.com/igbt/>

Potential applications

- Solar string inverter
- Solar micro inverter
- Industrial SMPS
- Industrial UPS
- Welding
- Energy storage
- Charger

Product validation

- Qualified for industrial applications according to the relevant tests of JEDEC47/20/22

Description

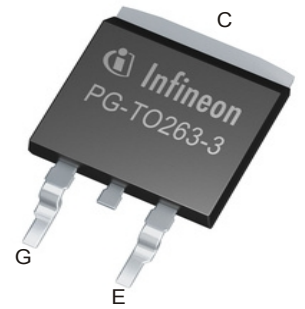
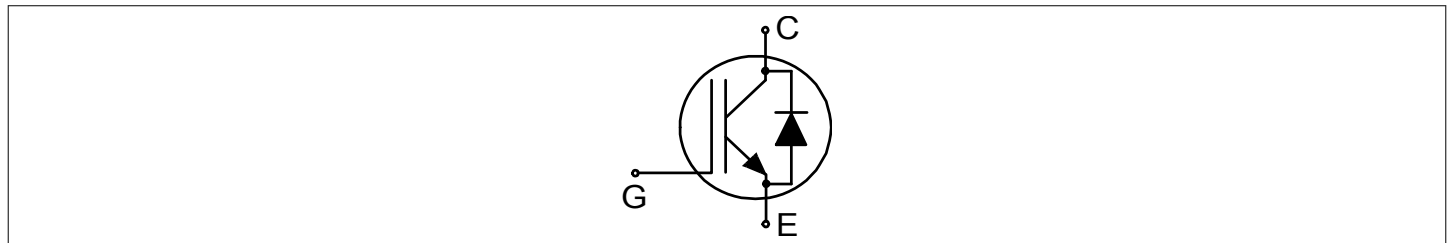

- Green
- Halogen-free
- RoHS

Type	Package	Marking
IKB30N65ES5	PG-TO263-3	K30EES5

Table of contents

	Description	1
	Features	1
	Potential applications	1
	Product validation	1
	Table of contents	2
1	Package	3
2	IGBT	3
3	Diode	6
4	Characteristics diagrams	9
5	Package outlines	15
6	Testing conditions	16
	Revision history	17
	Disclaimer	18

1 Package

Table 1 Characteristic values

Parameter	Symbol	Note or test condition	Values			Unit
			Min.	Typ.	Max.	
Internal emitter inductance measured 5 mm (0.197 in.) from case	L_E			7		nH
Storage temperature	T_{stg}		-55		150	°C
Soldering temperature	T_{sold}	reflow soldering (MSL1 according to JEDEC J-STA-020)			260	°C
Thermal resistance, min. footprint junction-ambient	$R_{th(j-a)}$				65	K/W
Thermal resistance, 6 cm ² Cu on PCB junction to ambient	$R_{th(j-a)}$				40	K/W
IGBT thermal resistance, junction-case	$R_{th(j-c)}$				0.8	K/W
Diode thermal resistance, junction-case	$R_{th(j-c)}$				1	K/W

2 IGBT

Table 2 Maximum rated values

Parameter	Symbol	Note or test condition	Values	Unit
Collector-emitter voltage	V_{CE}	$T_{vj} \geq 25\text{ °C}$	650	V
DC collector current, limited by T_{vjmax}	I_C	$T_c = 25\text{ °C}$	62	A
		$T_c = 100\text{ °C}$	39.5	
Pulsed collector current, t_p limited by T_{vjmax}	I_{Cpulse}		120	A
Turn-off safe operating area		$V_{CE} \leq 650\text{ V}$, $t_p = 1\text{ }\mu\text{s}$, $T_{vj} \leq 175\text{ °C}$	120	A
Gate-emitter voltage	V_{GE}		± 20	V
Transient gate-emitter voltage	V_{GE}	$t_p \leq 10\text{ }\mu\text{s}$, $D < 0.01$	± 30	V
Power dissipation	P_{tot}	$T_c = 25\text{ °C}$	188	W
		$T_c = 100\text{ °C}$	94	

Table 3 Characteristic values

Parameter	Symbol	Note or test condition	Values			Unit
			Min.	Typ.	Max.	
Collector-emitter breakdown voltage	V_{BRCES}	$I_C = 0.2 \text{ mA}, V_{GE} = 0 \text{ V}$	650			V
Collector-emitter saturation voltage	V_{CESat}	$I_C = 30 \text{ A}, V_{GE} = 15 \text{ V}$	$T_{vj} = 25 \text{ °C}$	1.35	1.7	V
			$T_{vj} = 125 \text{ °C}$	1.5		
			$T_{vj} = 175 \text{ °C}$	1.6		
Gate-emitter threshold voltage	V_{GETh}	$I_C = 0.3 \text{ mA}, V_{CE} = V_{GE}$	3.2	4	4.8	V
Zero gate-voltage collector current	I_{CES}	$V_{CE} = 650 \text{ V}, V_{GE} = 0 \text{ V}$	$T_{vj} = 25 \text{ °C}$		50	μA
			$T_{vj} = 175 \text{ °C}$		1400	
Gate-emitter leakage current	I_{GES}	$V_{CE} = 0 \text{ V}, V_{GE} = 20 \text{ V}$			100	nA
Transconductance	g_{fs}	$I_C = 30 \text{ A}, V_{CE} = 20 \text{ V}$		42		S
Input capacitance	C_{ies}	$V_{CE} = 25 \text{ V}, V_{GE} = 0 \text{ V}, f = 1000 \text{ kHz}$		1800		pF
Output capacitance	C_{oes}	$V_{CE} = 25 \text{ V}, V_{GE} = 0 \text{ V}, f = 1000 \text{ kHz}$		55		pF
Reverse transfer capacitance	C_{res}	$V_{CE} = 25 \text{ V}, V_{GE} = 0 \text{ V}, f = 1000 \text{ kHz}$		7		pF
Gate charge	Q_G	$I_C = 30 \text{ A}, V_{CC} = 520 \text{ V}, V_{GE} = 15 \text{ V}$		70		nC
Turn-on delay time	$t_{d(on)}$	$V_{CC} = 400 \text{ V}, V_{GE} = 0/15 \text{ V},$ $R_{G(on)} = 13 \text{ }\Omega,$ $R_{G(off)} = 13 \text{ }\Omega$	$T_{vj} = 25 \text{ °C},$ $I_C = 30 \text{ A}$		17	ns
			$T_{vj} = 25 \text{ °C},$ $I_C = 15 \text{ A}$		16	
			$T_{vj} = 150 \text{ °C},$ $I_C = 30 \text{ A}$		17	
			$T_{vj} = 150 \text{ °C},$ $I_C = 15 \text{ A}$		16	
Rise time (inductive load)	t_r	$V_{CC} = 400 \text{ V}, V_{GE} = 0/15 \text{ V},$ $R_{G(on)} = 13 \text{ }\Omega,$ $R_{G(off)} = 13 \text{ }\Omega$	$T_{vj} = 25 \text{ °C},$ $I_C = 30 \text{ A}$		12	ns
			$T_{vj} = 25 \text{ °C},$ $I_C = 15 \text{ A}$		6	
			$T_{vj} = 150 \text{ °C},$ $I_C = 30 \text{ A}$		13	
			$T_{vj} = 150 \text{ °C},$ $I_C = 15 \text{ A}$		7	

(table continues...)

Table 3 (continued) Characteristic values

Parameter	Symbol	Note or test condition	Values			Unit
			Min.	Typ.	Max.	
Turn-off delay time	$t_{d(off)}$	$V_{CC} = 400\text{ V}, V_{GE} = 0/15\text{ V},$ $R_{G(on)} = 13\ \Omega,$ $R_{G(off)} = 13\ \Omega$	$T_{vj} = 25\ ^\circ\text{C},$ $I_C = 30\text{ A}$		124	ns
			$T_{vj} = 25\ ^\circ\text{C},$ $I_C = 15\text{ A}$		133	
			$T_{vj} = 150\ ^\circ\text{C},$ $I_C = 30\text{ A}$		149	
			$T_{vj} = 150\ ^\circ\text{C},$ $I_C = 15\text{ A}$		179	
Fall time (inductive load)	t_f	$V_{CC} = 400\text{ V}, V_{GE} = 0/15\text{ V},$ $R_{G(on)} = 13\ \Omega,$ $R_{G(off)} = 13\ \Omega$	$T_{vj} = 25\ ^\circ\text{C},$ $I_C = 30\text{ A}$		30	ns
			$T_{vj} = 25\ ^\circ\text{C},$ $I_C = 15\text{ A}$		33	
			$T_{vj} = 150\ ^\circ\text{C},$ $I_C = 30\text{ A}$		55	
			$T_{vj} = 150\ ^\circ\text{C},$ $I_C = 15\text{ A}$		54	
Turn-on energy	E_{on}	$V_{CC} = 400\text{ V}, V_{GE} = 0/15\text{ V},$ $R_{G(on)} = 13\ \Omega,$ $R_{G(off)} = 13\ \Omega$	$T_{vj} = 25\ ^\circ\text{C},$ $I_C = 30\text{ A}$		0.56	mJ
			$T_{vj} = 25\ ^\circ\text{C},$ $I_C = 15\text{ A}$		0.26	
			$T_{vj} = 150\ ^\circ\text{C},$ $I_C = 30\text{ A}$		0.77	
			$T_{vj} = 150\ ^\circ\text{C},$ $I_C = 15\text{ A}$		0.41	
Turn-off energy	E_{off}	$V_{CC} = 400\text{ V}, V_{GE} = 0/15\text{ V},$ $R_{G(on)} = 13\ \Omega,$ $R_{G(off)} = 13\ \Omega$	$T_{vj} = 25\ ^\circ\text{C},$ $I_C = 30\text{ A}$		0.32	mJ
			$T_{vj} = 25\ ^\circ\text{C},$ $I_C = 15\text{ A}$		0.17	
			$T_{vj} = 150\ ^\circ\text{C},$ $I_C = 30\text{ A}$		0.56	
			$T_{vj} = 150\ ^\circ\text{C},$ $I_C = 15\text{ A}$		0.31	

(table continues...)

Table 3 (continued) Characteristic values

Parameter	Symbol	Note or test condition	Values			Unit	
			Min.	Typ.	Max.		
Total switching energy	E_{ts}	$V_{CC} = 400\text{ V}, V_{GE} = 0/15\text{ V},$ $R_{G(on)} = 13\ \Omega,$ $R_{G(off)} = 13\ \Omega$	$T_{vj} = 25\text{ }^\circ\text{C},$ $I_C = 30\text{ A}$		0.88		mJ
			$T_{vj} = 25\text{ }^\circ\text{C},$ $I_C = 15\text{ A}$		0.43		
			$T_{vj} = 150\text{ }^\circ\text{C},$ $I_C = 30\text{ A}$		1.33		
			$T_{vj} = 150\text{ }^\circ\text{C},$ $I_C = 15\text{ A}$		0.72		
Operating junction temperature	T_{vj}		-40		175	$^\circ\text{C}$	

3 Diode

Table 4 Maximum rated values

Parameter	Symbol	Note or test condition	Values	Unit	
Repetitive peak reverse voltage	V_{RRM}	$T_{vj} \geq 25\text{ }^\circ\text{C}$	650	V	
Diode forward current, limited by T_{vjmax}	I_F	limited by bondwire	$T_c = 25\text{ }^\circ\text{C}$	40	A
			$T_c = 100\text{ }^\circ\text{C}$	39.5	
Diode pulsed current, t_p limited by T_{vjmax}	I_{Fpulse}		120	A	

Table 5 Characteristic values

Parameter	Symbol	Note or test condition	Values			Unit	
			Min.	Typ.	Max.		
Diode forward voltage	V_F	$I_F = 30\text{ A}$	$T_{vj} = 25\text{ }^\circ\text{C}$		1.45	1.7	V
			$T_{vj} = 125\text{ }^\circ\text{C}$		1.42		
			$T_{vj} = 175\text{ }^\circ\text{C}$		1.39		

(table continues...)

Table 5 (continued) Characteristic values

Parameter	Symbol	Note or test condition	Values			Unit	
			Min.	Typ.	Max.		
Diode reverse recovery time	t_{rr}	$V_R = 400\text{ V}$	$T_{vj} = 25\text{ °C}$, $I_F = 30\text{ A}$, $-di_F/dt = 1200\text{ A}/\mu\text{s}$		75		ns
			$T_{vj} = 25\text{ °C}$, $I_F = 15\text{ A}$, $-di_F/dt = 1900\text{ A}/\mu\text{s}$		52		
			$T_{vj} = 150\text{ °C}$, $I_F = 30\text{ A}$, $-di_F/dt = 1200\text{ A}/\mu\text{s}$		110		
			$T_{vj} = 150\text{ °C}$, $I_F = 15\text{ A}$, $-di_F/dt = 1900\text{ A}/\mu\text{s}$		78		
Diode reverse recovery charge	Q_{rr}	$V_R = 400\text{ V}$	$T_{vj} = 25\text{ °C}$, $I_F = 30\text{ A}$, $-di_F/dt = 1200\text{ A}/\mu\text{s}$		0.83		μC
			$T_{vj} = 25\text{ °C}$, $I_F = 15\text{ A}$, $-di_F/dt = 1900\text{ A}/\mu\text{s}$		0.6		
			$T_{vj} = 150\text{ °C}$, $I_F = 30\text{ A}$, $-di_F/dt = 1200\text{ A}/\mu\text{s}$		1.75		
			$T_{vj} = 150\text{ °C}$, $I_F = 15\text{ A}$, $-di_F/dt = 1900\text{ A}/\mu\text{s}$		1.25		
Diode peak reverse recovery current	I_{rrm}	$V_R = 400\text{ V}$	$T_{vj} = 25\text{ °C}$, $I_F = 30\text{ A}$, $-di_F/dt = 1200\text{ A}/\mu\text{s}$		18		A
			$T_{vj} = 25\text{ °C}$, $I_F = 15\text{ A}$, $-di_F/dt = 1900\text{ A}/\mu\text{s}$		18.5		
			$T_{vj} = 150\text{ °C}$, $I_F = 30\text{ A}$, $-di_F/dt = 1200\text{ A}/\mu\text{s}$		26.5		
			$T_{vj} = 150\text{ °C}$, $I_F = 15\text{ A}$, $-di_F/dt = 1900\text{ A}/\mu\text{s}$		26.2		

(table continues...)

Table 5 (continued) Characteristic values

Parameter	Symbol	Note or test condition		Values			Unit
				Min.	Typ.	Max.	
Diode peak rate of fall of reverse recovery current	di_{rr}/dt	$V_R = 400\text{ V}$	$T_{vj} = 25\text{ °C},$ $I_F = 30\text{ A},$ $-di_F/dt = 1200\text{ A}/\mu\text{s}$		900		A/ μs
			$T_{vj} = 25\text{ °C},$ $I_F = 15\text{ A},$ $-di_F/dt = 1900\text{ A}/\mu\text{s}$		1320		
			$T_{vj} = 150\text{ °C},$ $I_F = 30\text{ A},$ $-di_F/dt = 1200\text{ A}/\mu\text{s}$		1000		
			$T_{vj} = 150\text{ °C},$ $I_F = 15\text{ A},$ $-di_F/dt = 1900\text{ A}/\mu\text{s}$		1200		
Operating junction temperature	T_{vj}			-40		175	°C

Note: For optimum lifetime and reliability, Infineon recommends operating conditions that do not exceed 80% of the maximum ratings stated in this datasheet.

Electrical Characteristic at $T_{vj} = 25\text{ °C}$, unless otherwise specified.

Dynamic test circuit, parasitic inductance $L_\sigma = 30\text{ nH}$, parasitic capacitor $C_\sigma = 30\text{ pF}$ from Fig. E. Energy losses include “tail” and diode reverse recovery.

4 Characteristics diagrams

Power dissipation as a function of heatsink temperature

$P_{tot} = f(T_c)$
 $T_{vj} \leq 175\text{ °C}$

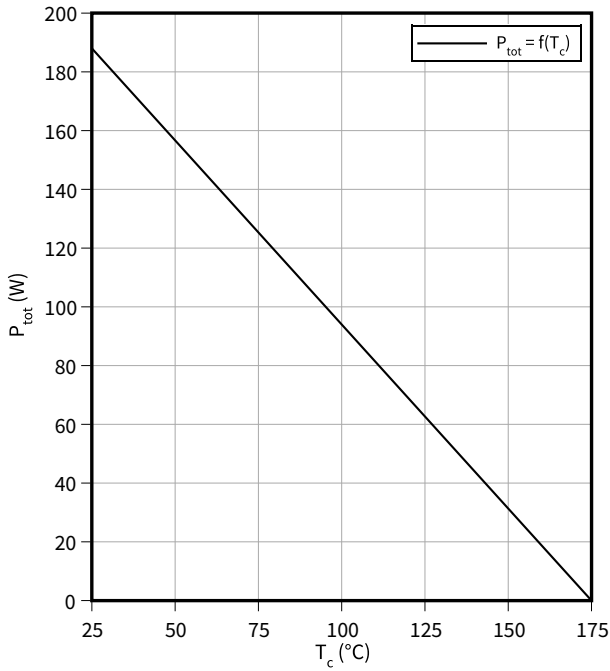

Collector current as a function of case temperature

$I_C = f(T_c)$
 $T_{vj} \leq 175\text{ °C}, V_{GE} \geq 15\text{ V}$

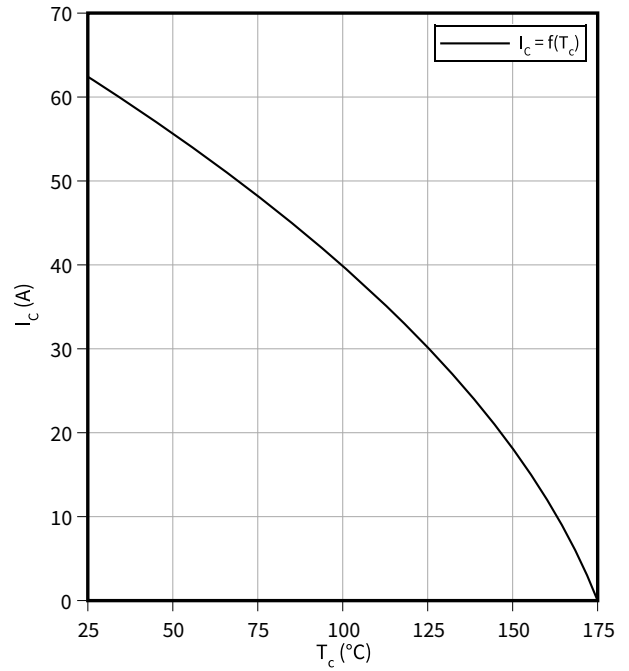

Typical output characteristic

$I_C = f(V_{CE})$
 $T_{vj} = 25\text{ °C}$

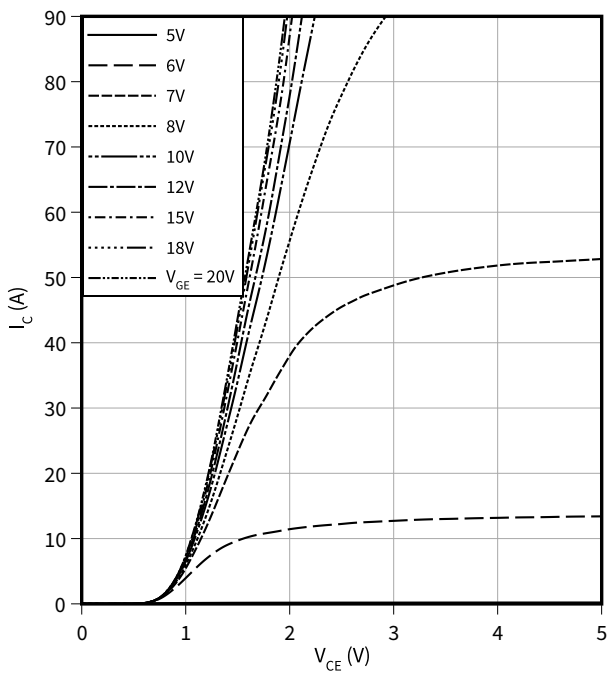

Typical output characteristic

$I_C = f(V_{CE})$
 $T_{vj} = 150\text{ °C}$

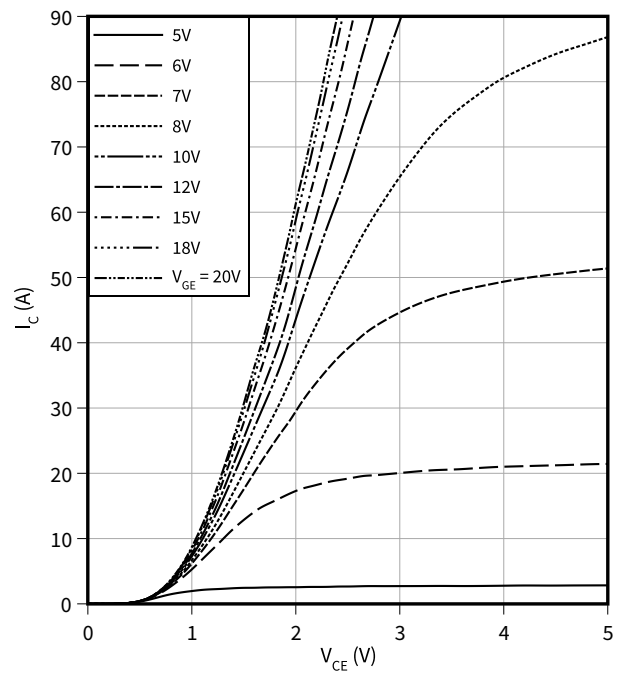

4 Characteristics diagrams

Typical transfer characteristic

$I_C = f(V_{GE})$
 $V_{CE} = 20\text{ V}$

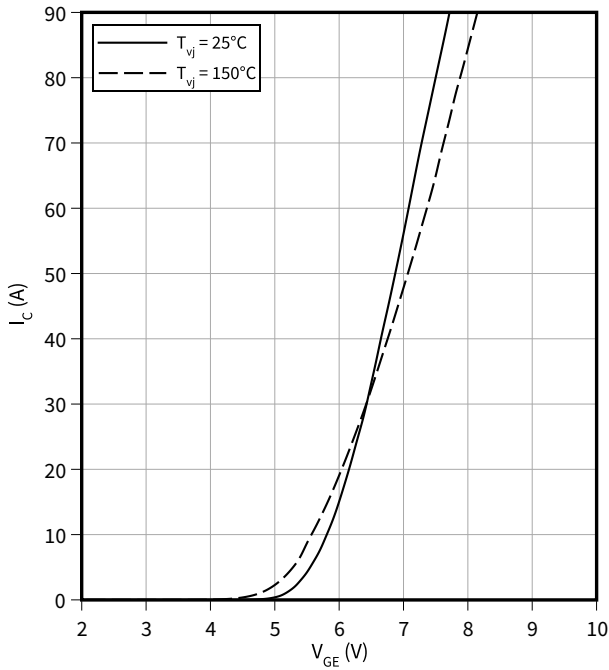

Typical collector-emitter saturation voltage as a function of junction temperature

$V_{CEsat} = f(T_{vj})$
 $V_{GE} = 15\text{ V}$

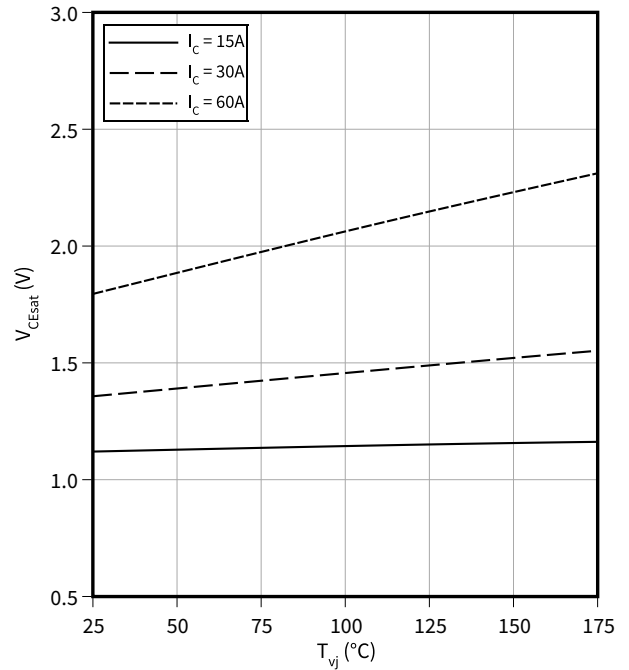

Gate-emitter threshold voltage as a function of junction temperature

$V_{GEth} = f(T_{vj})$
 $I_C = 0.3\text{ mA}$

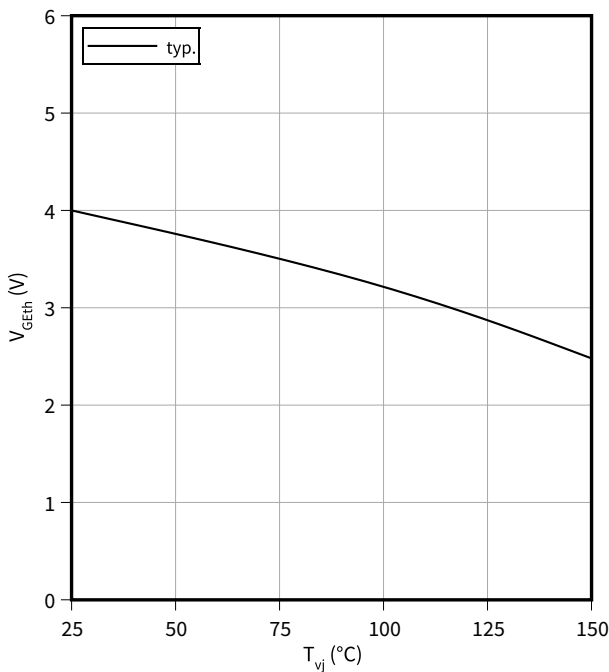

Typical switching times as a function of collector current

$t = f(I_C)$
 $V_{CC} = 400\text{ V}, T_{vj} = 150^\circ\text{C}, V_{GE} = 0/15\text{ V}, R_G = 13\ \Omega$

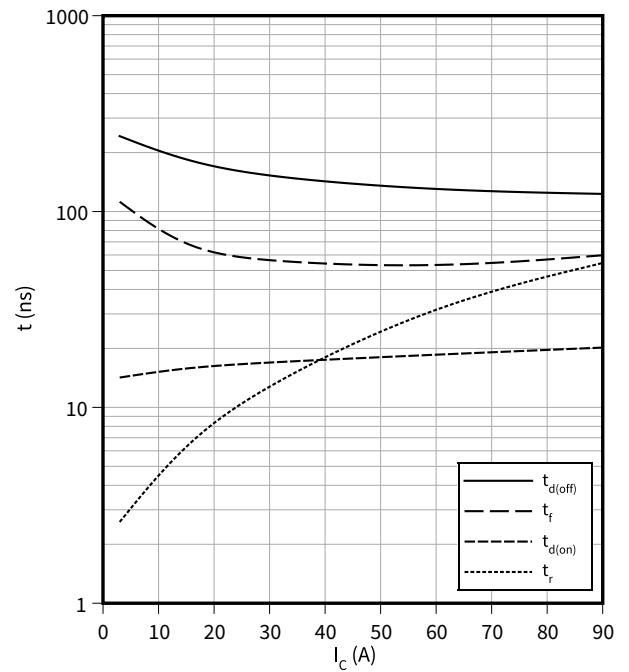

4 Characteristics diagrams

Typical switching times as a function of gate resistor

$t = f(R_G)$

$I_C = 30\text{ A}$, $V_{CC} = 400\text{ V}$, $T_{vj} = 150\text{ °C}$, $V_{GE} = 0/15\text{ V}$

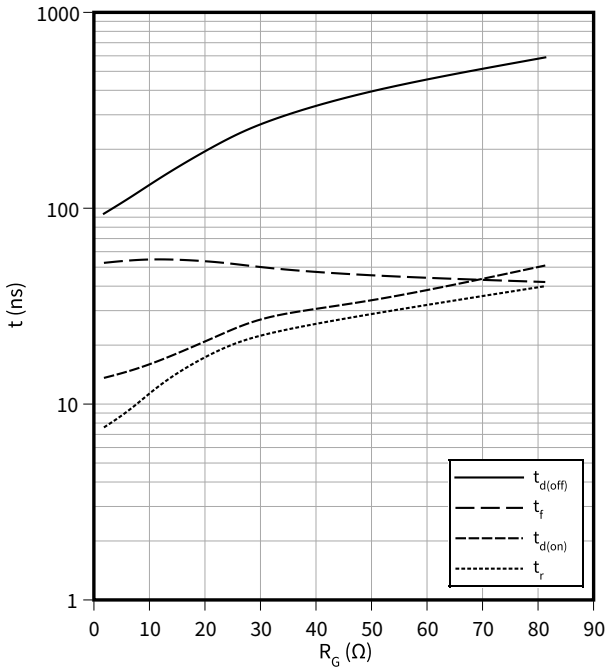

Typical switching times as a function of junction temperature

$t = f(T_{vj})$

$I_C = 30\text{ A}$, $V_{CC} = 400\text{ V}$, $V_{GE} = 0/15\text{ V}$, $R_G = 13\text{ }\Omega$

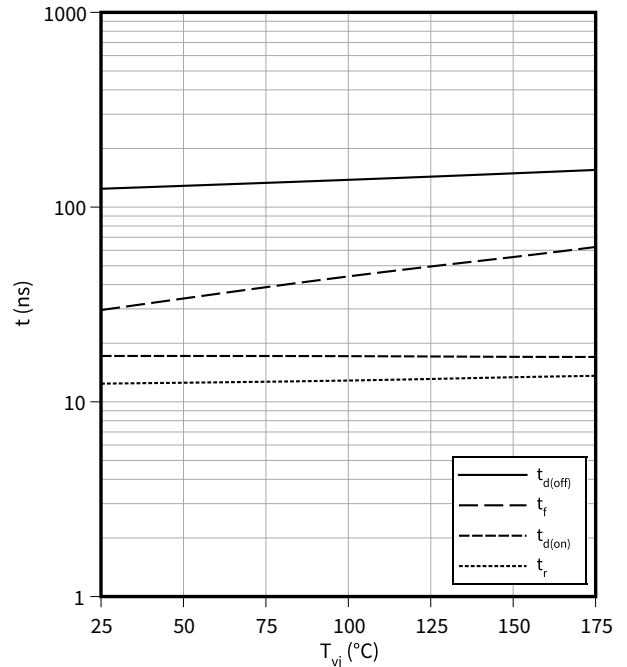

Typical switching energy losses as a function of collector current

$E = f(I_C)$

$V_{CC} = 400\text{ V}$, $T_{vj} = 150\text{ °C}$, $V_{GE} = 0/15\text{ V}$, $R_G = 13\text{ }\Omega$

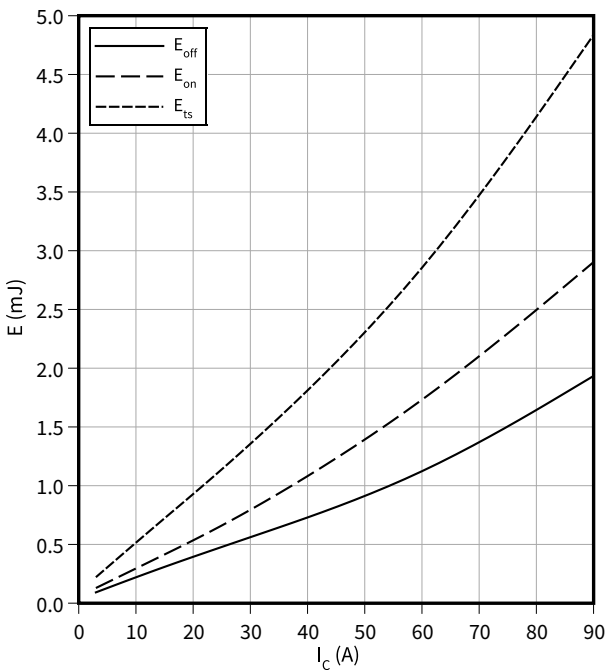

Typical switching energy losses as a function of gate resistor

$E = f(R_G)$

$I_C = 30\text{ A}$, $V_{CC} = 400\text{ V}$, $T_{vj} = 150\text{ °C}$, $V_{GE} = 0/15\text{ V}$

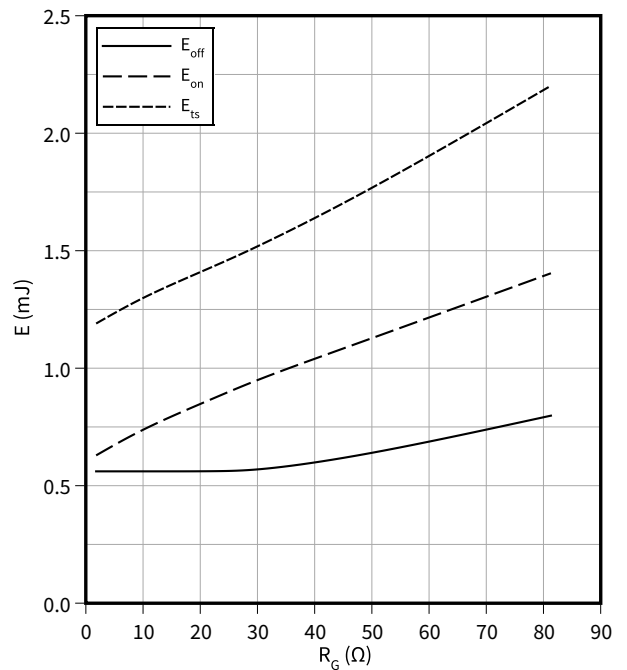

4 Characteristics diagrams

Typical switching energy losses as a function of junction temperature

$E = f(T_{vj})$

$I_C = 30\text{ A}$, $V_{CC} = 400\text{ V}$, $V_{GE} = 0/15\text{ V}$, $R_G = 13\ \Omega$

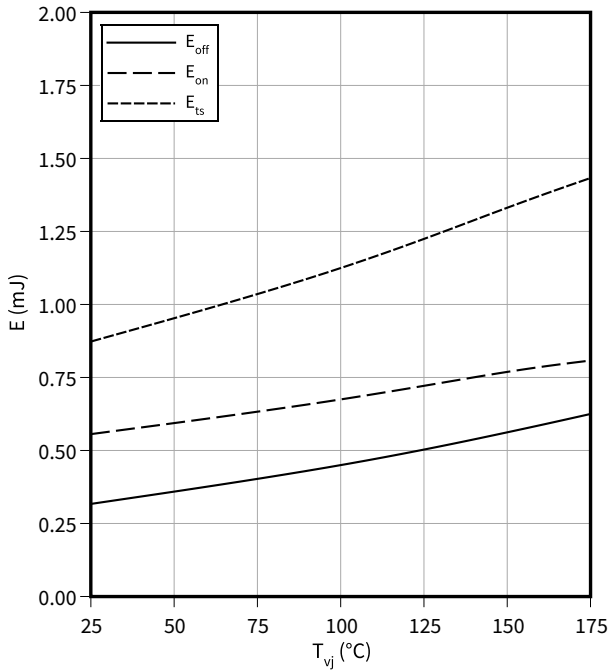

Typical switching energy losses as a function of collector emitter voltage

$E = f(V_{CE})$

$I_C = 30\text{ A}$, $T_{vj} = 150\text{ °C}$, $V_{GE} = 0/15\text{ V}$, $R_G = 13\ \Omega$

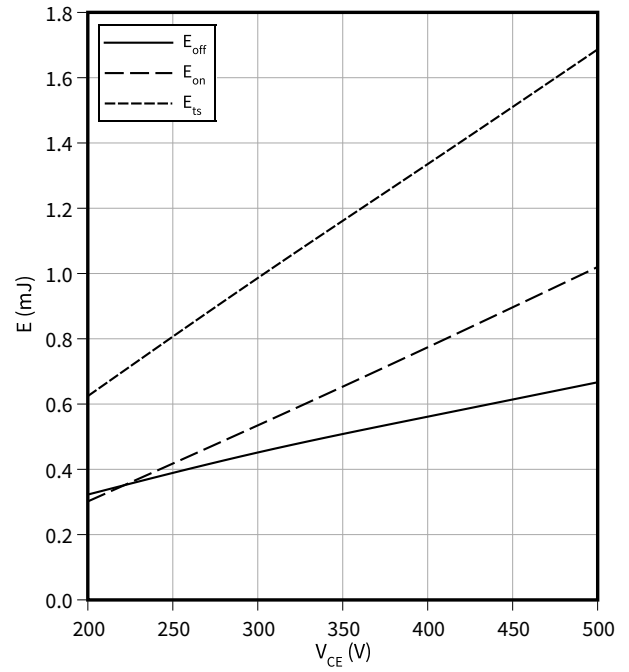

Typical gate charge

$V_{GE} = f(Q_G)$

$I_C = 30\text{ A}$

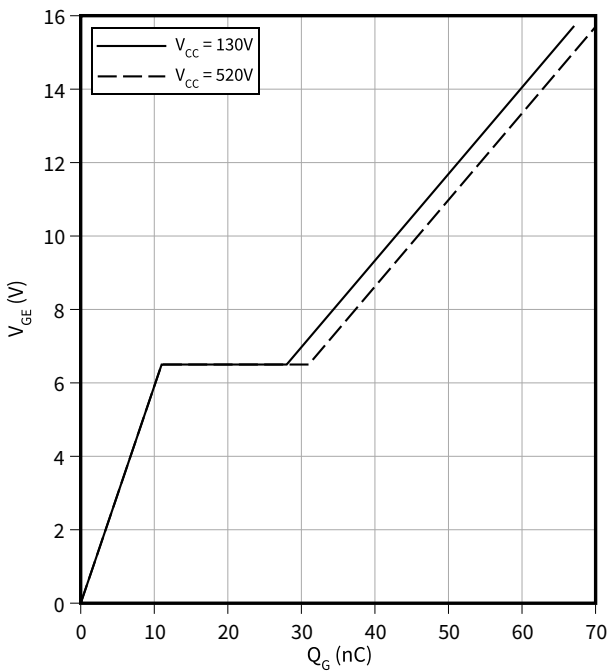

Typical capacitance as a function of collector-emitter voltage

$C = f(V_{CE})$

$f = 1000\text{ kHz}$, $V_{GE} = 0\text{ V}$

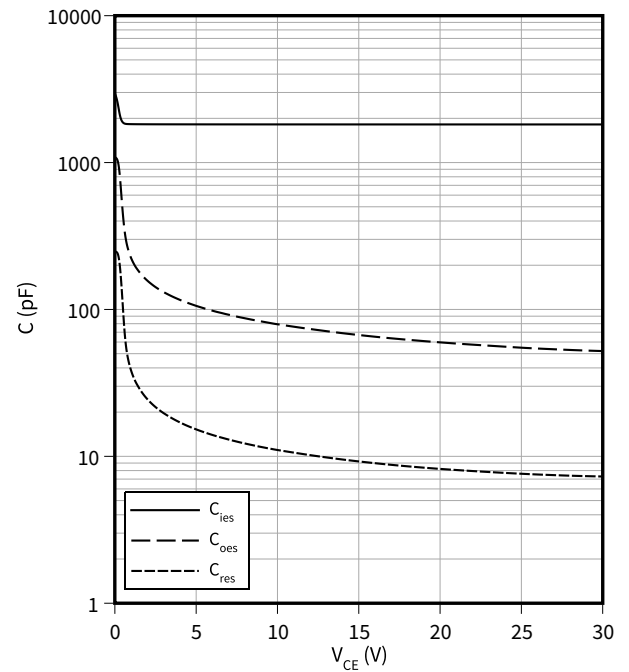

4 Characteristics diagrams

IGBT transient thermal impedance as a function of pulse width

$Z_{th(j-c)} = f(t_p)$
 $D = t_p/T$

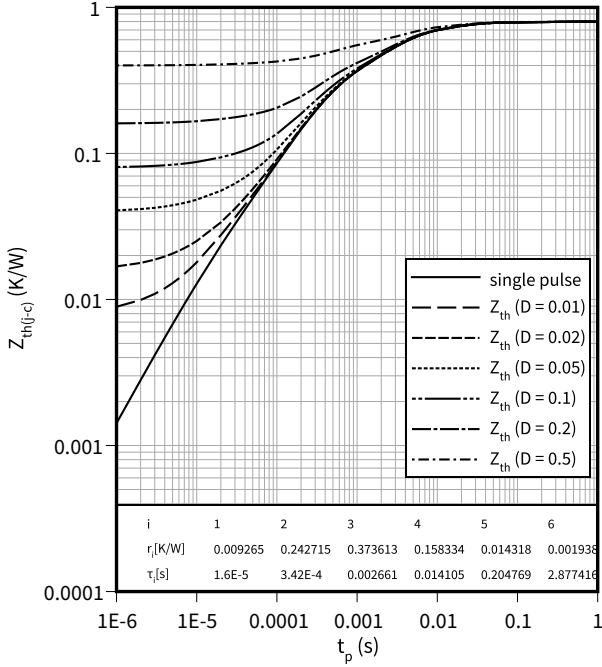

Diode transient thermal impedance as a function of pulse width

$Z_{th(j-c)} = f(t_p)$
 $D = t_p/T$

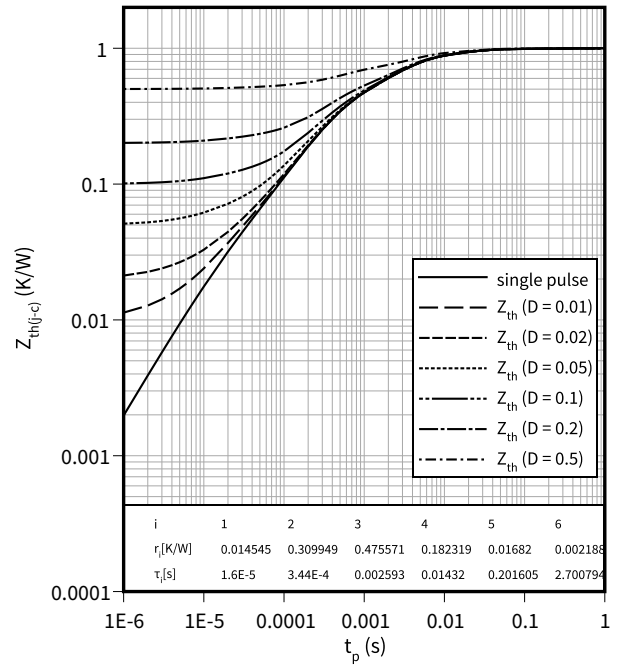

Typical diode forward current as a function of forward voltage

$I_F = f(V_F)$

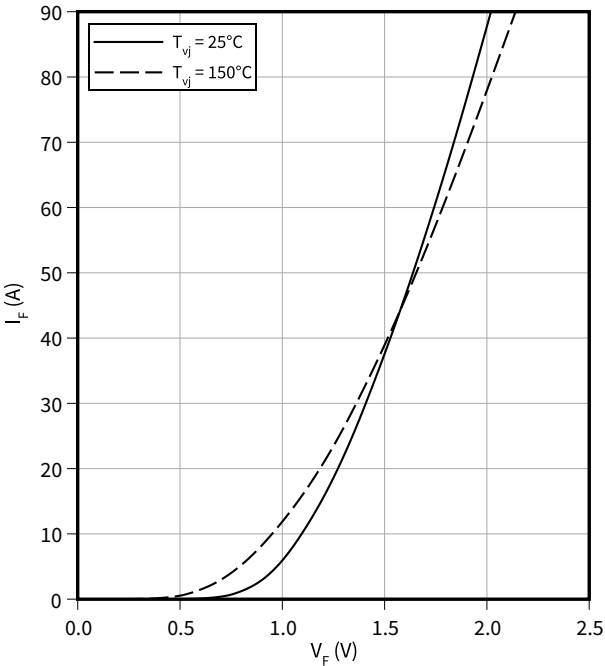

Typical diode forward voltage as a function of junction temperature

$V_F = f(T_{vj})$

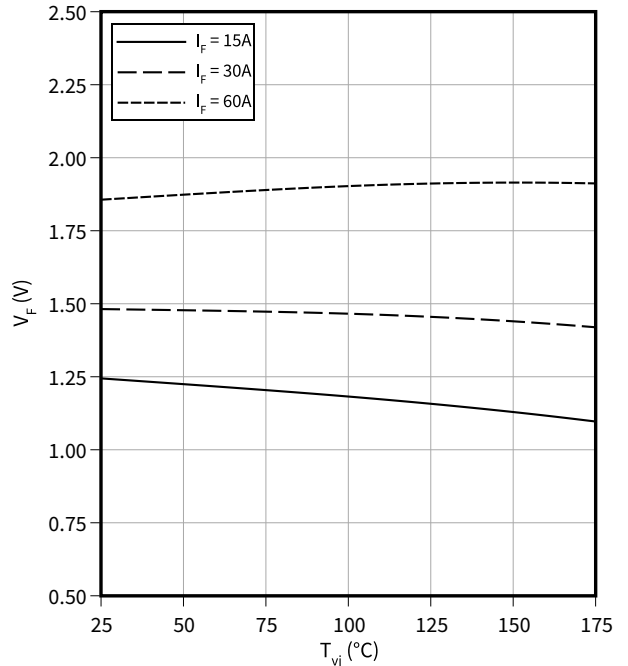

4 Characteristics diagrams

Typical reverse recovery time as a function of diode current slope

$$t_{rr} = f(di_F/dt)$$

$V_R = 400\text{ V}, I_F = 30\text{ A}$

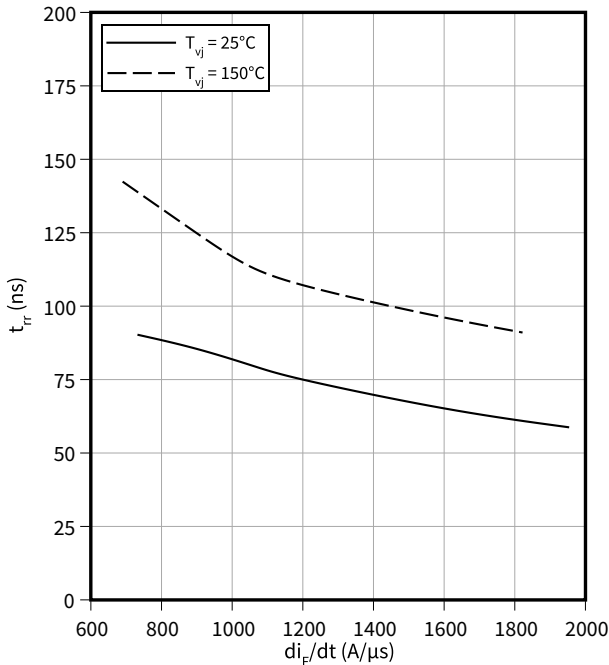

Typical reverse recovery charge as a function of diode current slope

$$Q_{rr} = f(di_F/dt)$$

$V_R = 400\text{ V}, I_F = 30\text{ A}$

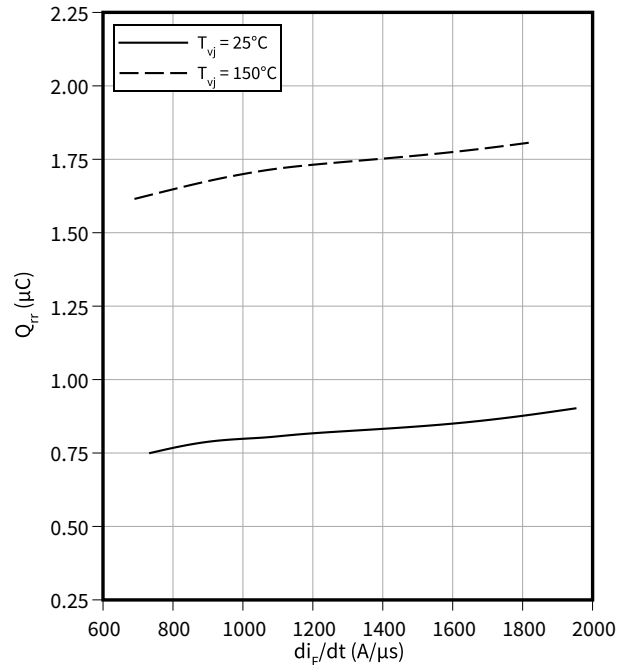

Typical reverse recovery current as a function of diode current slope

$$I_{rrm} = f(di_F/dt)$$

$V_R = 400\text{ V}, I_F = 30\text{ A}$

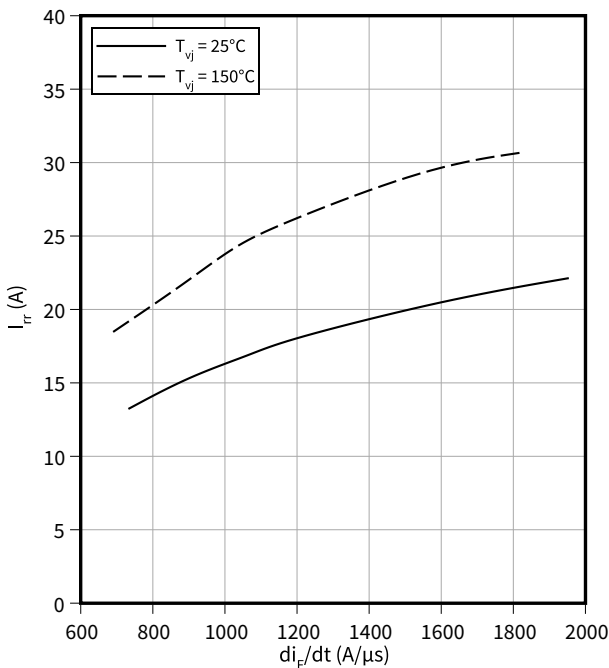

Typical diode peak rate of fall of reverse recovery current as a function of diode current slope

$$di_{rr}/dt = f(di_F/dt)$$

$V_R = 400\text{ V}, I_F = 30\text{ A}$

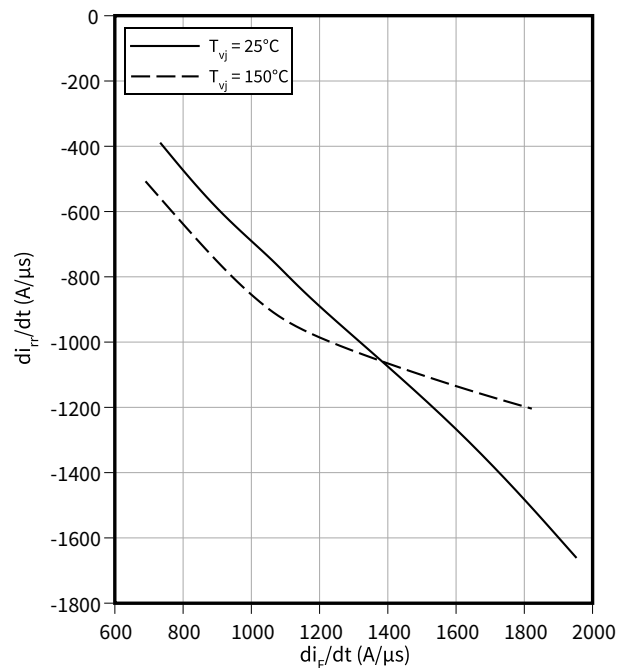

5 Package outlines

Package Drawing PG-TO263-3

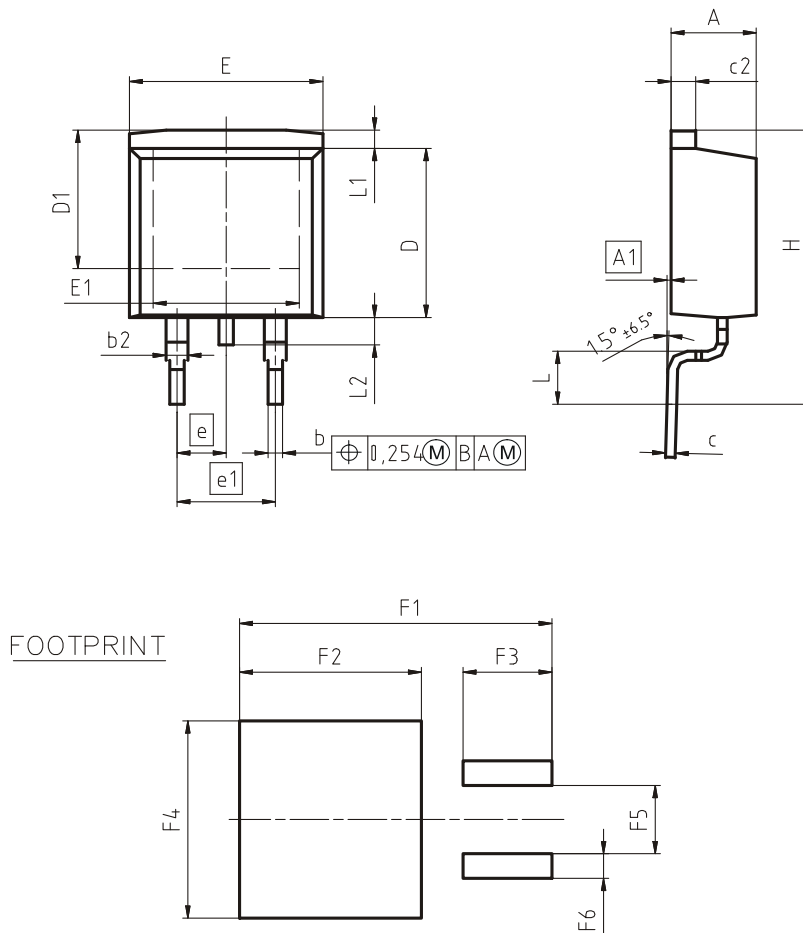

DIM	MILLIMETERS		INCHES	
	MIN	MAX	MIN	MAX
A	4.30	4.57	0.169	0.180
A1	0.00	0.25	0.000	0.010
b	0.65	0.85	0.026	0.033
b2	0.95	1.15	0.037	0.045
c	0.33	0.65	0.013	0.026
c2	1.17	1.40	0.046	0.055
D	8.51	9.45	0.335	0.372
D1	7.10	7.90	0.280	0.311
E	9.80	10.31	0.386	0.406
E1	6.50	8.60	0.256	0.339
e	2.54		0.100	
e1	5.08		0.200	
N	2		2	
H	14.61	15.88	0.575	0.625
L	2.29	3.00	0.090	0.118
L1	0.70	1.60	0.028	0.063
L2	1.00	1.78	0.039	0.070
F1	16.05	16.25	0.632	0.640
F2	9.30	9.50	0.366	0.374
F3	4.50	4.70	0.177	0.185
F4	10.70	10.90	0.421	0.429
F5	3.65	3.85	0.144	0.152
F6	1.25	1.45	0.049	0.057

DOCUMENT NO.
Z8B00003324

SCALE

7.5mm

EUROPEAN PROJECTION

ISSUE DATE
30-08-2007

REVISION
01

Figure 1

6 Testing conditions

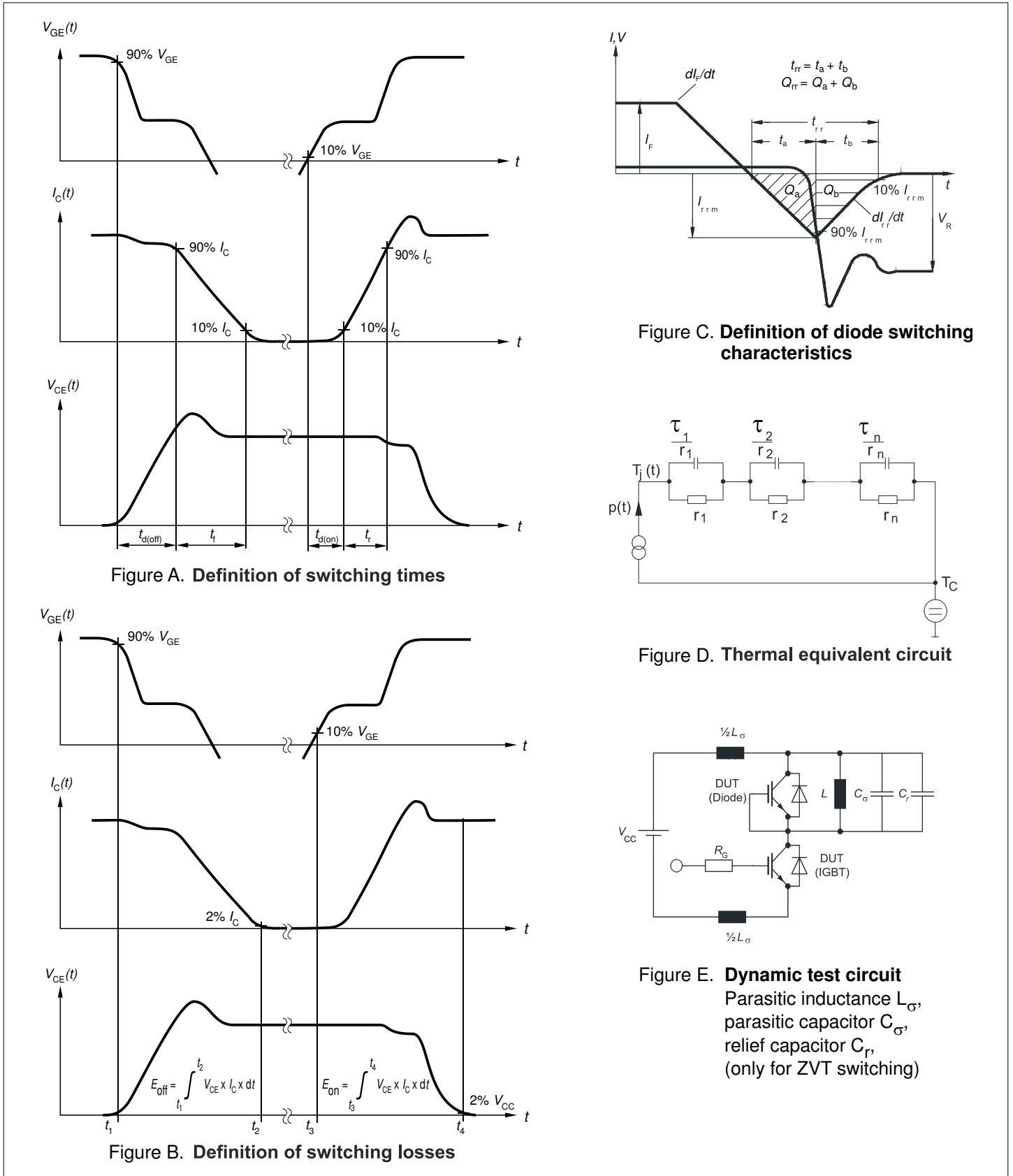

Figure 2

Revision history

Document revision	Date of release	Description of changes
V2.1	2018-01-11	Final data sheet
n/a	2020-11-30	Datasheet migrated to a new system with a new layout and new revision number schema: target or preliminary datasheet = 0.xy; final datasheet = 1.xy
1.10	2023-01-17	Correction of diagram: “Typical switching energy losses as a function of collector emitter voltage” Editorial changes

Trademarks

All referenced product or service names and trademarks are the property of their respective owners.

Edition 2023-01-17

Published by

Infineon Technologies AG

81726 Munich, Germany

© 2023 Infineon Technologies AG

All Rights Reserved.

Do you have a question about any aspect of this document?

Email: erratum@infineon.com

Document reference

IFX-AAL192-002

Important notice

The information given in this document shall in no event be regarded as a guarantee of conditions or characteristics ("Beschaffheitsgarantie").

With respect to any examples, hints or any typical values stated herein and/or any information regarding the application of the product, Infineon Technologies hereby disclaims any and all warranties and liabilities of any kind, including without limitation warranties of non-infringement of intellectual property rights of any third party.

In addition, any information given in this document is subject to customer's compliance with its obligations stated in this document and any applicable legal requirements, norms and standards concerning customer's products and any use of the product of Infineon Technologies in customer's applications.

The data contained in this document is exclusively intended for technically trained staff. It is the responsibility of customer's technical departments to evaluate the suitability of the product for the intended application and the completeness of the product information given in this document with respect to such application.

Please note that this product is not qualified according to the AEC Q100 or AEC Q101 documents of the Automotive Electronics Council.

Warnings

Due to technical requirements products may contain dangerous substances. For information on the types in question please contact your nearest Infineon Technologies office.

Except as otherwise explicitly approved by Infineon Technologies in a written document signed by authorized representatives of Infineon Technologies, Infineon Technologies' products may not be used in any applications where a failure of the product or any consequences of the use thereof can reasonably be expected to result in personal injury.

Mouser Electronics

Authorized Distributor

Click to View Pricing, Inventory, Delivery & Lifecycle Information:

[Infineon:](#)

[IKB30N65ES5ATMA1](#)