

Aug.1.2020 Copyright 2020 HIROSE ELECTRIC CO., LTD. All Rights Reserved.
In case of consideration for using Automotive equipment / device which demand high reliability, kindly contact our sales window correspondents.

COUNT	DESCRIPTION OF REVISIONS	BY	CHKD	DATE	COUNT	DESCRIPTION OF REVISIONS	BY	CHKD	DATE
1	DIS-C-000585	T.K	E.K	07.07.27					

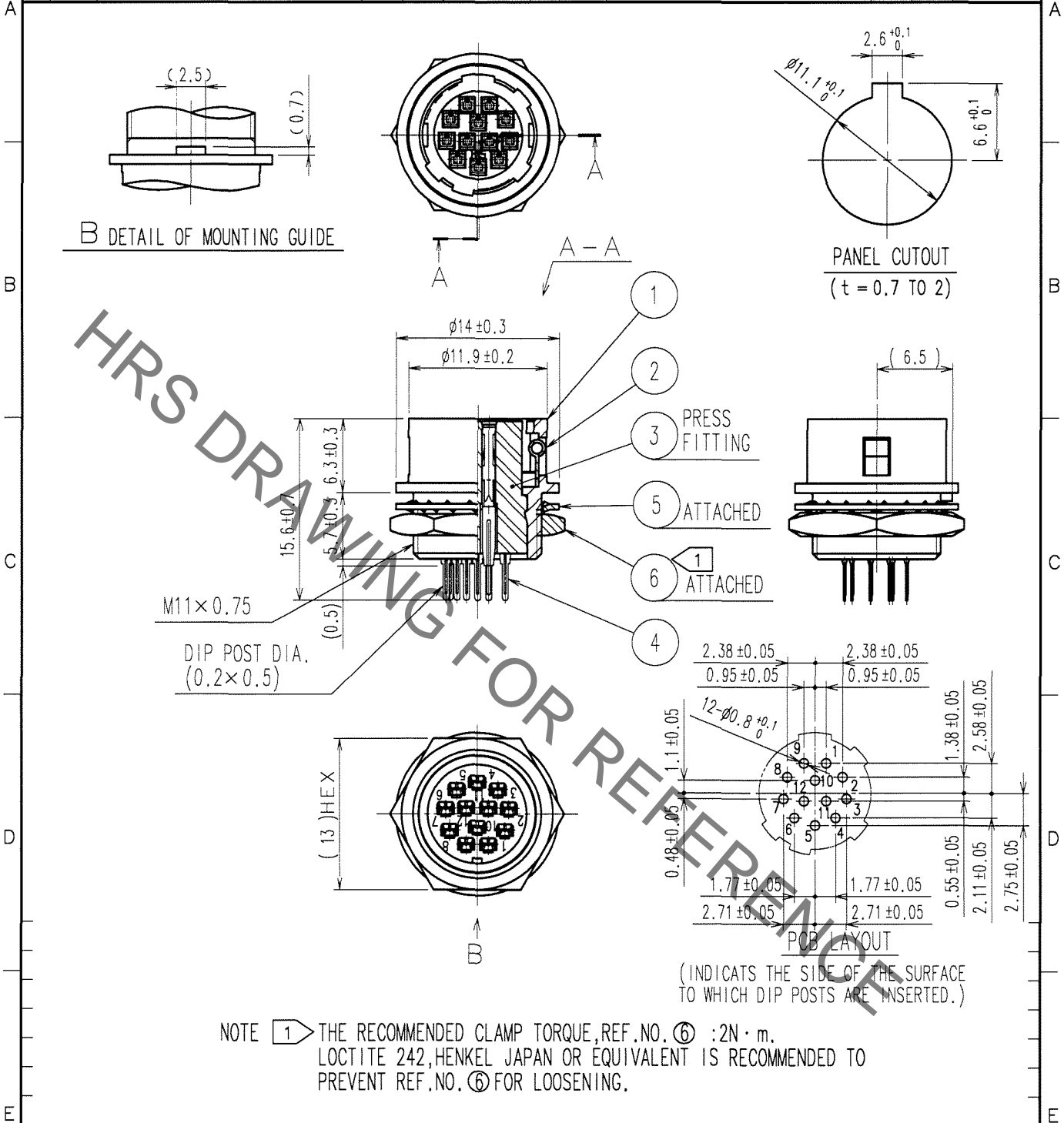

NOTE ① THE RECOMMENDED CLAMP TORQUE, REF. NO. ⑥ : 2N · m.
LOCTITE 242, HENKEL JAPAN OR EQUIVALENT IS RECOMMENDED TO PREVENT REF. NO. ⑥ FOR LOOSENING.

3	POLYBUTYLENE TEREPHTHALATE (BLACK)	UL94V-0	6	BRASS	NICKEL PLATING
2	STAINLESS STEEL		5	PHOSPHOR BRONZE	NICKEL PLATING
1	ZINC ALLOY	MATTE FINISH NICKEL PLATED	4	PHOSPHOR BRONZE	SILVER PLATING 2μ m min.
NO.	MATERIAL	FINISH, REMARKS	NO.	MATERIAL	FINISH, REMARKS

CODE NO. (OLD)	CL	DRAWN	DESIGNED	CHECKED	APPROVED	RELEASED
		M.SATO	T.HORII	E.KUNII	M.SATO	
		'07 04 11	'07 04 11	'07 04 11	'07 04 11	

DRAWING NO.	PART NO.
EDC4-042756-71	HR10G-10R-12SB(71)
UNITS	CODE NO.
mm	CL110-1809-2-71

TO
R

Mouser Electronics

Authorized Distributor

Click to View Pricing, Inventory, Delivery & Lifecycle Information:

[Hirose Electric:](#)

[HR10G-10R-12SB\(71\)](#)