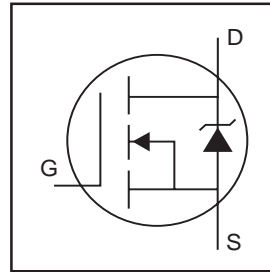


# IRFZ46NS

# IRFZ46NL

HEXFET® Power MOSFET

- Advanced Process Technology
- Surface Mount (IRFZ46NS)
- Low-profile through-hole (IRFZ46NL)
- 175°C Operating Temperature
- Fast Switching
- Fully Avalanche Rated



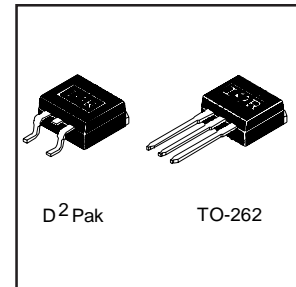
$V_{DSS} = 55V$
$R_{DS(on)} = 0.0165\Omega$
$I_D = 53A^{\circ}$

## Description

Advanced HEXFET® Power MOSFETs from International Rectifier utilize advanced processing techniques to achieve extremely low on-resistance per silicon area. This benefit, combined with the fast switching speed and ruggedized device design that HEXFET power MOSFETs are well known for, provides the designer with an extremely efficient and reliable device for use in a wide variety of applications.

The D<sup>2</sup>Pak is a surface mount power package capable of accommodating die sizes up to HEX-4. It provides the highest power capability and the lowest possible on-resistance in any existing surface mount package. The D<sup>2</sup>Pak is suitable for high current applications because of its low internal connection resistance and can dissipate up to 2.0W in a typical surface mount application.

The through-hole version (IRFZ46NL) is available for low-profile applications.



## Absolute Maximum Ratings

	Parameter	Max.	Units
$I_D @ T_C = 25^\circ C$	Continuous Drain Current, $V_{GS} @ 10V^{\circ}$	53 $^{\circ}$	A
$I_D @ T_C = 100^\circ C$	Continuous Drain Current, $V_{GS} @ 10V^{\circ}$	37	
$I_{DM}$	Pulsed Drain Current $^{\circ}$ $^{\circ}$	180	
$P_D @ T_A = 25^\circ C$	Power Dissipation	3.8	W
$P_D @ T_C = 25^\circ C$	Power Dissipation	107	W
	Linear Derating Factor	0.71	W/ $^\circ C$
$V_{GS}$	Gate-to-Source Voltage	$\pm 20$	V
$I_{AR}$	Avalanche Current $^{\circ}$	28	A
$E_{AR}$	Repetitive Avalanche Energy $^{\circ}$	11	mJ
$dv/dt$	Peak Diode Recovery $dv/dt$ $^{\circ}$ $^{\circ}$	5.0	V/ns
$T_J$	Operating Junction and	-55 to + 175	$^\circ C$
$T_{STG}$	Storage Temperature Range		
	Soldering Temperature, for 10 seconds	300 (1.6mm from case )	

## Thermal Resistance

	Parameter	Typ.	Max.	Units
$R_{\theta JC}$	Junction-to-Case	---	1.4	$^\circ C/W$
$R_{\theta JA}$	Junction-to-Ambient ( PCB Mounted, steady-state)**	---	40	

# IRFZ46NS/IRFZ46NL

International  
IR Rectifier

## Electrical Characteristics @ T<sub>J</sub> = 25°C (unless otherwise specified)

	Parameter	Min.	Typ.	Max.	Units	Conditions
V <sub>(BR)DSS</sub>	Drain-to-Source Breakdown Voltage	55	—	—	V	V <sub>GS</sub> = 0V, I <sub>D</sub> = 250μA
ΔV <sub>(BR)DSS</sub> /ΔT <sub>J</sub>	Breakdown Voltage Temp. Coefficient	—	0.057	—	V/°C	Reference to 25°C, I <sub>D</sub> = 1mA <sup>⑤</sup>
R <sub>DS(on)</sub>	Static Drain-to-Source On-Resistance	—	—	.0165	Ω	V <sub>GS</sub> = 10V, I <sub>D</sub> = 28A <sup>④</sup>
V <sub>GS(th)</sub>	Gate Threshold Voltage	2.0	—	4.0	V	V <sub>DS</sub> = V <sub>GS</sub> , I <sub>D</sub> = 250μA
g <sub>fs</sub>	Forward Transconductance	19	—	—	S	V <sub>DS</sub> = 25V, I <sub>D</sub> = 28A <sup>④⑤</sup>
I <sub>DSS</sub>	Drain-to-Source Leakage Current	—	—	25	μA	V <sub>DS</sub> = 55V, V <sub>GS</sub> = 0V
		—	—	250		V <sub>DS</sub> = 44V, V <sub>GS</sub> = 0V, T <sub>J</sub> = 150°C
I <sub>GSS</sub>	Gate-to-Source Forward Leakage	—	—	100	nA	V <sub>GS</sub> = 20V
	Gate-to-Source Reverse Leakage	—	—	-100		V <sub>GS</sub> = -20V
Q <sub>g</sub>	Total Gate Charge	—	—	72	nC	I <sub>D</sub> = 28A
Q <sub>gs</sub>	Gate-to-Source Charge	—	—	11		V <sub>DS</sub> = 44V
Q <sub>gd</sub>	Gate-to-Drain ("Miller") Charge	—	—	26		V <sub>GS</sub> = 10V, See Fig. 6 and 13 <sup>④⑤</sup>
t <sub>d(on)</sub>	Turn-On Delay Time	—	14	—	ns	V <sub>DD</sub> = 28V
t <sub>r</sub>	Rise Time	—	76	—		I <sub>D</sub> = 28A
t <sub>d(off)</sub>	Turn-Off Delay Time	—	52	—		R <sub>G</sub> = 12Ω
t <sub>f</sub>	Fall Time	—	57	—		R <sub>D</sub> = 0.98Ω, See Fig. 10 <sup>④⑤</sup>
L <sub>S</sub>	Internal Source Inductance	—	7.5	—	nH	Between lead, and center of die contact
C <sub>iss</sub>	Input Capacitance	—	1696	—	pF	V <sub>GS</sub> = 0V
C <sub>oss</sub>	Output Capacitance	—	407	—		V <sub>DS</sub> = 25V
C <sub>rss</sub>	Reverse Transfer Capacitance	—	110	—		f = 1.0MHz, See Fig. 5 <sup>⑤</sup>
E <sub>AS</sub>	Single Pulse Avalanche Energy <sup>②</sup>	—	583 <sup>⑥</sup>	152 <sup>⑦</sup>		I <sub>AS</sub> = 28A, L = 389mH

## Source-Drain Ratings and Characteristics

	Parameter	Min.	Typ.	Max.	Units	Conditions
I <sub>S</sub>	Continuous Source Current (Body Diode)	—	—	53	A	MOSFET symbol showing the integral reverse p-n junction diode.
I <sub>SM</sub>	Pulsed Source Current (Body Diode) <sup>①</sup>	—	—	180		
V <sub>SD</sub>	Diode Forward Voltage	—	—	1.3	V	T <sub>J</sub> = 25°C, I <sub>S</sub> = 28A, V <sub>GS</sub> = 0V <sup>④</sup>
t <sub>rr</sub>	Reverse Recovery Time	—	67	101	ns	T <sub>J</sub> = 25°C, I <sub>F</sub> = 28A
Q <sub>rr</sub>	Reverse Recovery Charge	—	208	312	nC	di/dt = 100A/μs <sup>④⑤</sup>
t <sub>on</sub>	Forward Turn-On Time	Intrinsic turn-on time is negligible (turn-on is dominated by L <sub>S</sub> +L <sub>D</sub> )				

### Notes:

- ① Repetitive rating; pulse width limited by max. junction temperature. ( See fig. 11 )
- ② Starting T<sub>J</sub> = 25°C, L = 389μH  
R<sub>G</sub> = 25Ω, I<sub>AS</sub> = 28A. (See Figure 12)
- ③ I<sub>SD</sub> ≤ 28A, di/dt ≤ 220A/μs, V<sub>DD</sub> ≤ V<sub>(BR)DSS</sub>,  
T<sub>J</sub> ≤ 175°C.
- ④ Pulse width ≤ 400μs; duty cycle ≤ 2%.
- ⑤ Uses IRFZ46N data and test conditions.
- ⑥ This is a typical value at device destruction and represents operation outside rated limits.
- ⑦ This is a calculated value limited to T<sub>J</sub> = 175°C.
- ⑧ Calculated continuous current based on maximum allowable junction temperature. Package limitation current is 39A.

\*\* When mounted on 1" square PCB (FR-4 or G-10 Material ).

For recommended footprint and soldering techniques refer to application note #AN-994.

# IRFZ46NS/IRFZ46NL

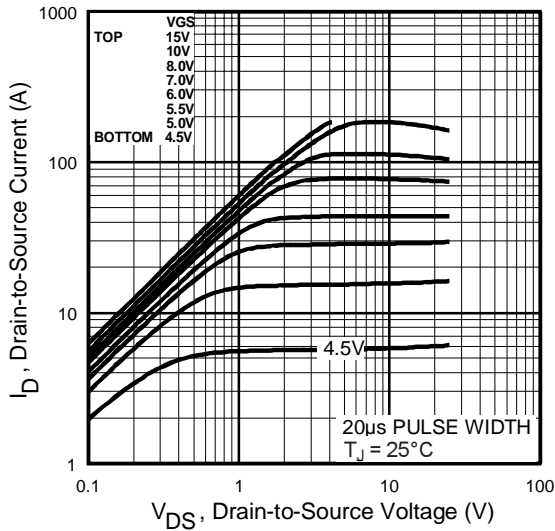


Fig 1. Typical Output Characteristics

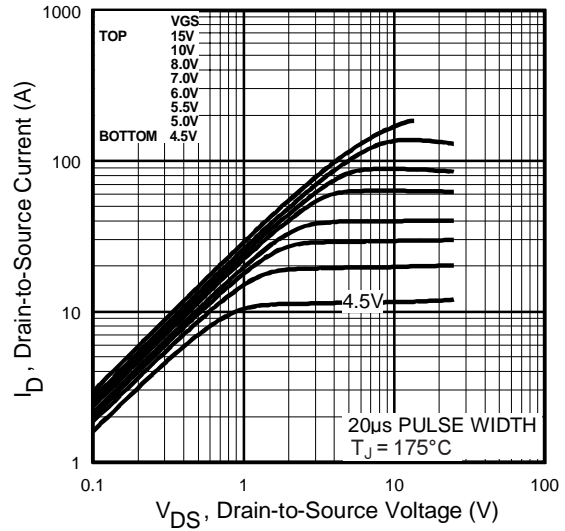


Fig 2. Typical Output Characteristics

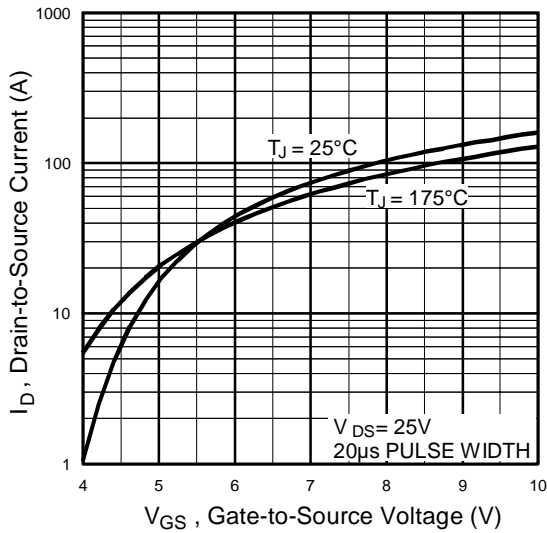


Fig 3. Typical Transfer Characteristics

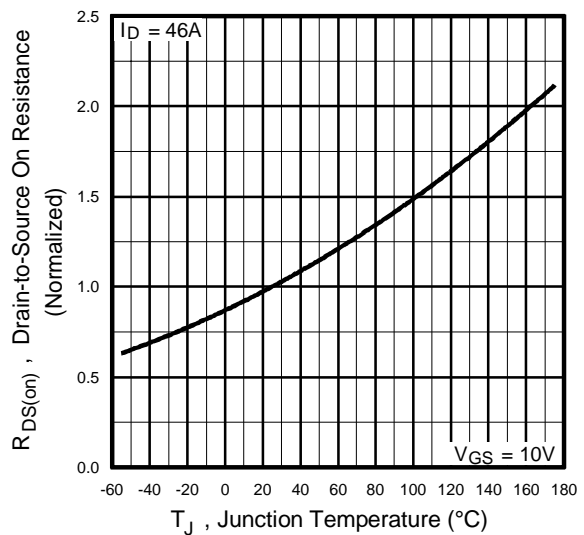
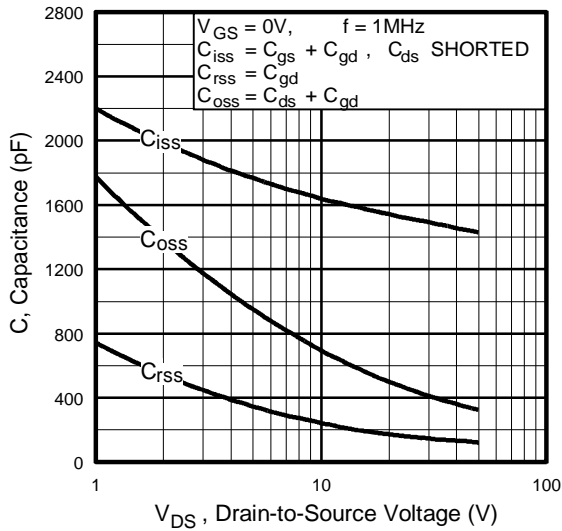


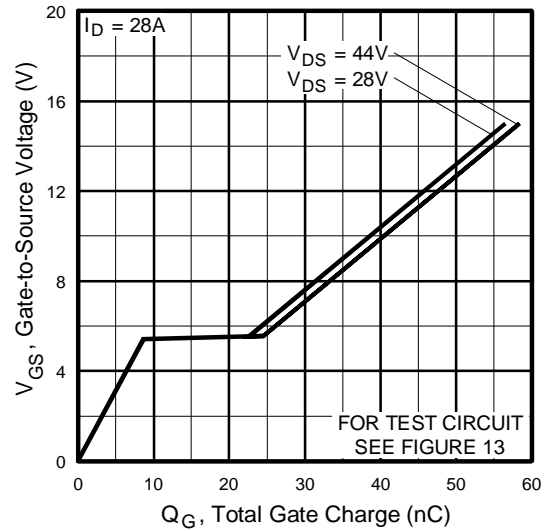
Fig 4. Normalized On-Resistance Vs. Temperature

# IRFZ46NS/IRFZ46NL

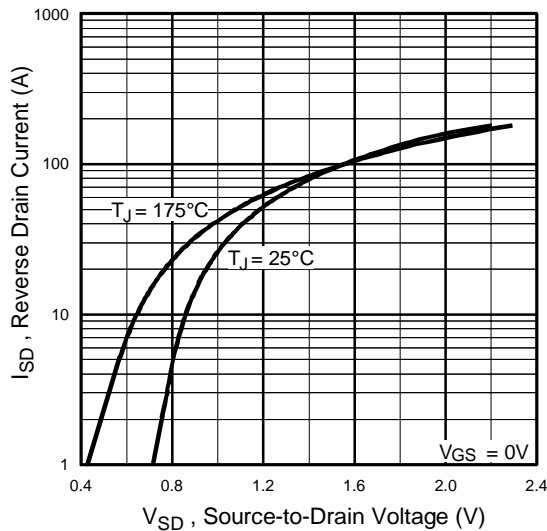
International  
**IR** Rectifier



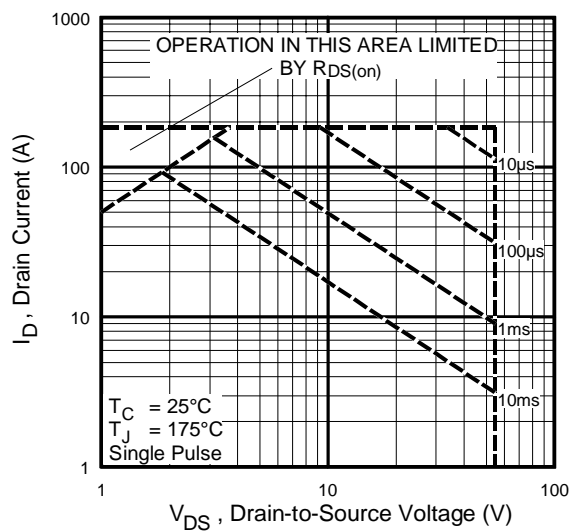
**Fig 5.** Typical Capacitance Vs. Drain-to-Source Voltage



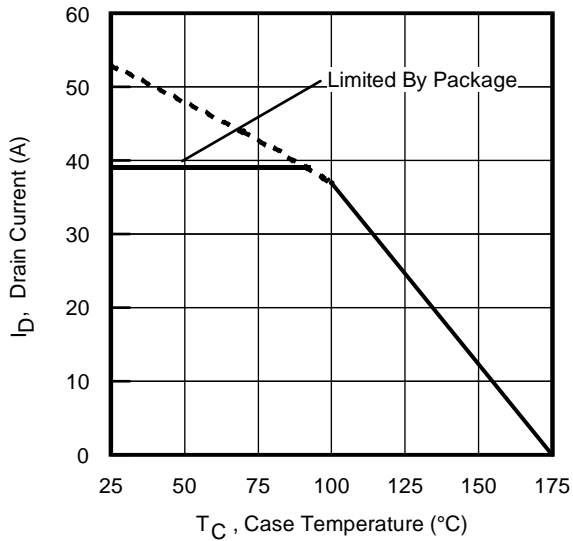
**Fig 6.** Typical Gate Charge Vs. Gate-to-Source Voltage



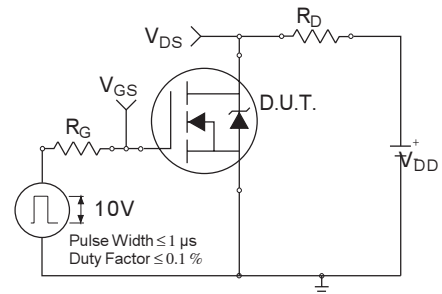
**Fig 7.** Typical Source-Drain Diode Forward Voltage



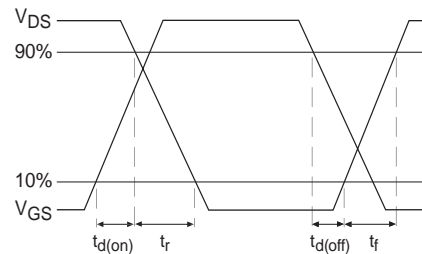
**Fig 8.** Maximum Safe Operating Area



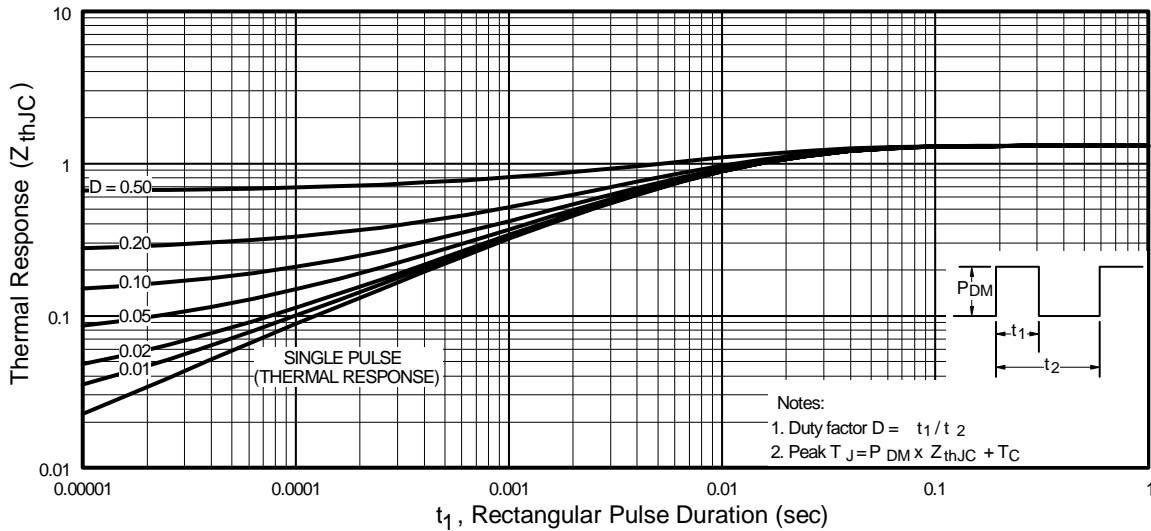
**Fig 9.** Maximum Drain Current Vs. Case Temperature



**Fig 10a.** Switching Time Test Circuit



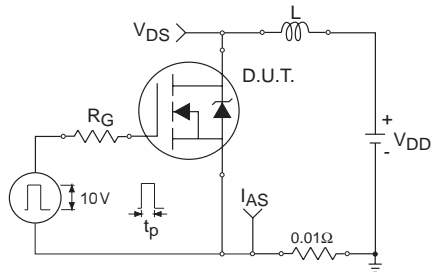
**Fig 10b.** Switching Time Waveforms



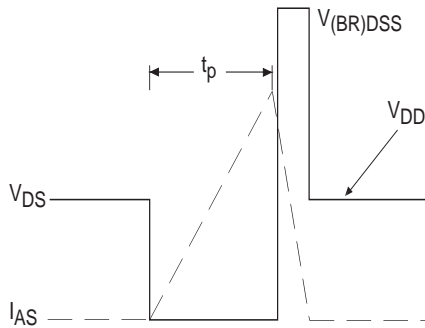
**Fig 11.** Maximum Effective Transient Thermal Impedance, Junction-to-Case

# IRFZ46NS/IRFZ46NL

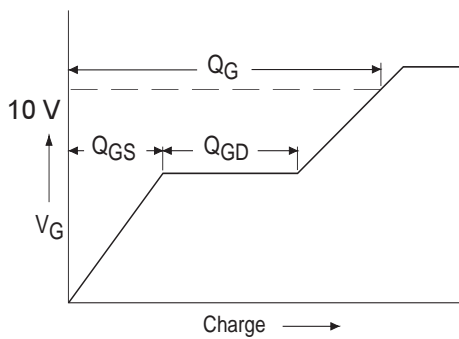
International  
**IR** Rectifier



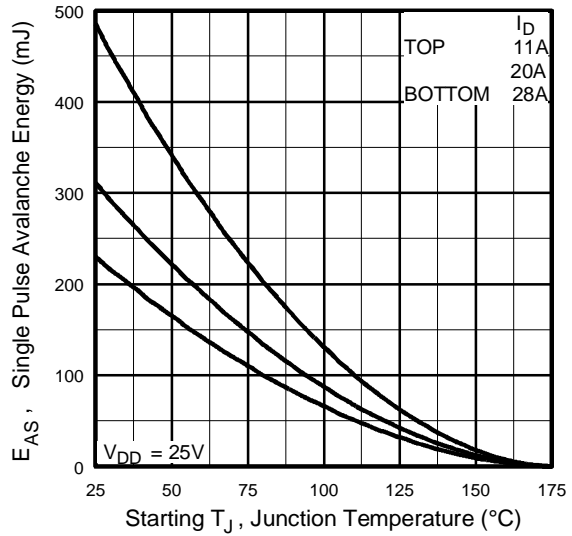
**Fig 12a.** Unclamped Inductive Test Circuit



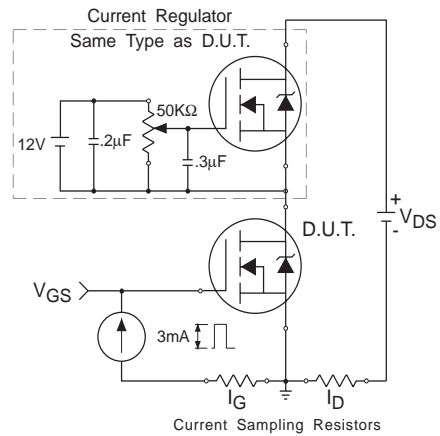
**Fig 12b.** Unclamped Inductive Waveforms



**Fig 13a.** Basic Gate Charge Waveform

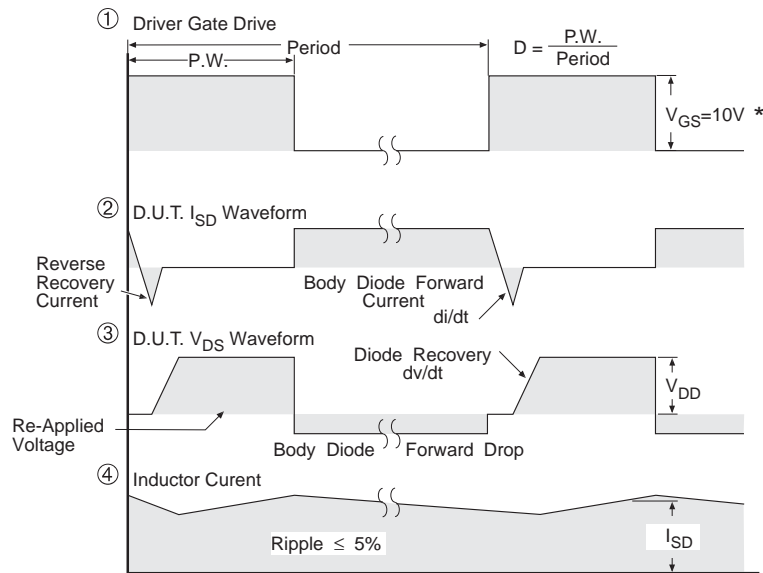


**Fig 12c.** Maximum Avalanche Energy Vs. Drain Current



**Fig 13b.** Gate Charge Test Circuit

## Peak Diode Recovery dv/dt Test Circuit



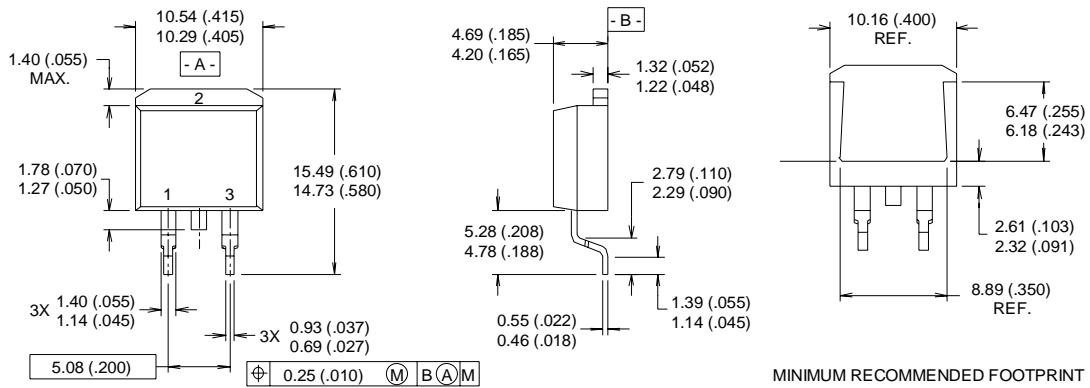
\*  $V_{GS} = 5V$  for Logic Level Devices

**Fig 14.** For N-Channel HEXFETS

# IRFZ46NS/IRFZ46NL

International  
**IR** Rectifier

## D<sup>2</sup>Pak Package Outline



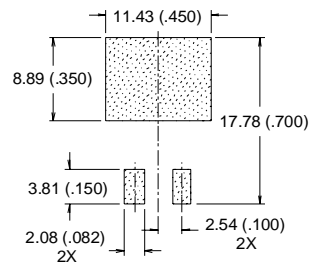
### NOTES:

- 1 DIMENSIONS AFTER SOLDER DIP.
- 2 DIMENSIONING & TOLERANCING PER ANSI Y14.5M, 1982.
- 3 CONTROLLING DIMENSION : INCH.
- 4 HEATSINK & LEAD DIMENSIONS DO NOT INCLUDE BURRS.

### LEAD ASSIGNMENTS

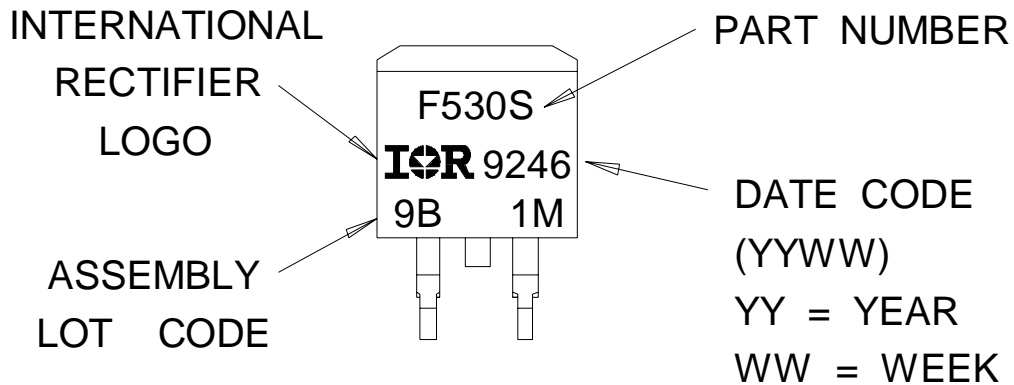
- 1 - GATE
- 2 - DRAIN
- 3 - SOURCE

### MINIMUM RECOMMENDED FOOTPRINT



## Part Marking Information

### D<sup>2</sup>Pak

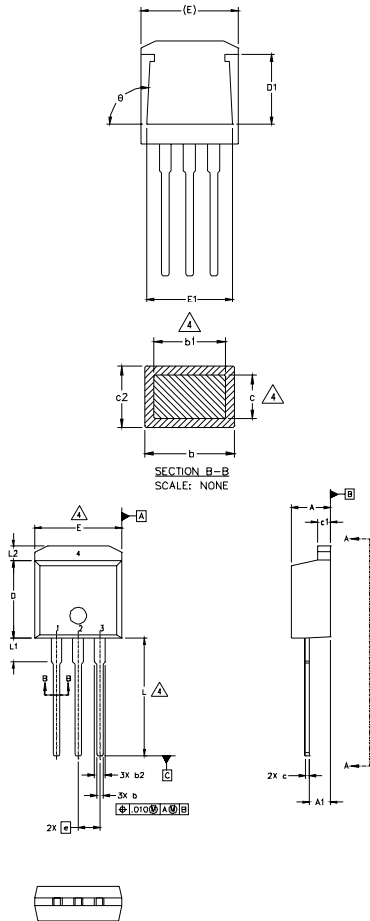




# IRFZ46NS/IRFZ46NL

## TO-262 Package Outline

Dimensions are shown in millimeters (inches)



SYMBOL	DIMENSIONS				NOTES
	MILLIMETERS		INCHES		
	MIN.	MAX.	MIN.	MAX.	
A	4.06	4.83	.160	.190	
A1	2.03	2.92	.080	.115	
b	0.51	0.99	.020	.039	
b1	0.51	0.89	.020	.035	4
b2	1.14	1.40	.045	.055	
c	0.38	0.63	.015	.025	4
c1	1.14	1.40	.045	.055	
c2	0.43	.063	.017	.029	
D	8.51	9.65	.335	.380	3
D1	5.33		.210		
E	9.65	10.67	.380	.420	3
E1	6.22		.245		
e	2.54 BSC		.100 BSC		
L	13.46	14.09	.530	.555	
L1	3.56	3.71	.140	.146	
L2		1.65		.065	

### LEAD ASSIGNMENTS

#### HEXFET

- 1.- GATE
- 2.- DRAIN
- 3.- SOURCE
- 4.- DRAIN

#### IGBT

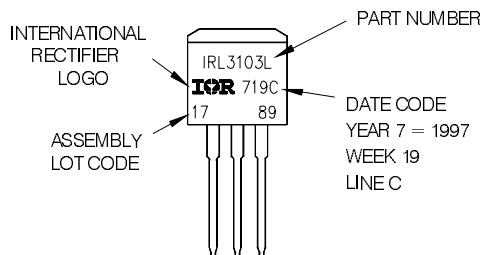
- 1- GATE
- 2- COLLECTOR
- 3- EMITTER

#### NOTES

1. DIMENSIONING AND TOLERANCING PER ASME Y14.5M-1994
2. DIMENSIONS ARE SHOWN IN MILLIMETERS [INCHES]
3. DIMENSION D & E DO NOT INCLUDE MOLD FLASH. MOLD FLASH SHALL NOT EXCEED 0.127 [0.005] PER SIDE. THESE DIMENSIONS ARE MEASURED AT THE OUTMOST EXTREMES OF THE PLASTIC BODY.
4. DIMENSION b1 AND c1 APPLY TO BASE METAL ONLY.
5. CONTROLLING DIMENSION: INCH.

## TO-262 Part Marking Information

EXAMPLE: THIS IS AN IRL3103L  
LOT CODE 1789  
ASSEMBLED ON WW 19, 1997  
IN THE ASSEMBLY LINE "C"

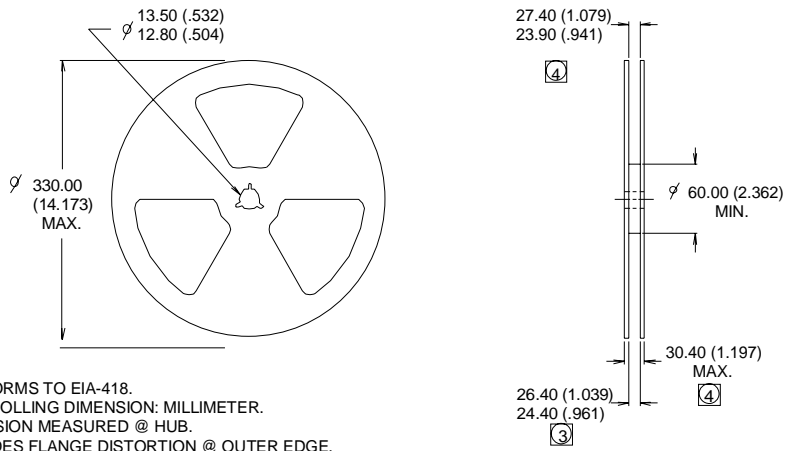
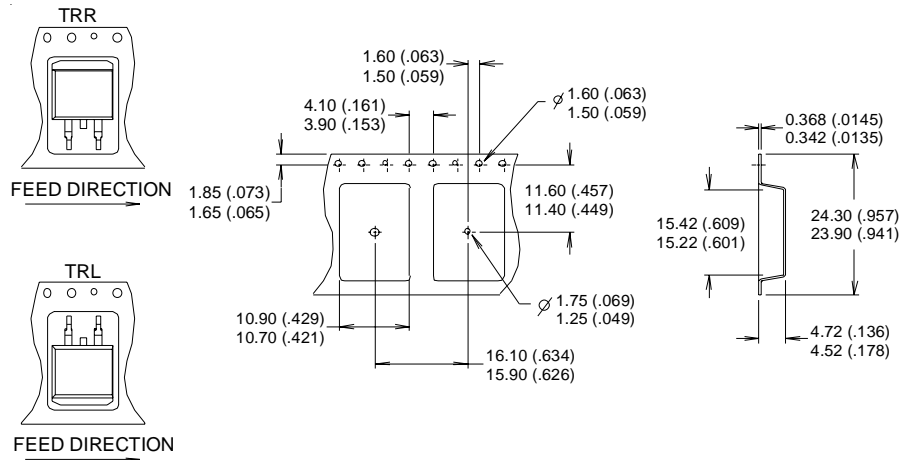


# IRFZ46NS/IRFZ46NL

International  
**IR** Rectifier

## Tape & Reel Information

D<sup>2</sup>Pak



- NOTES :
1. COMFORMS TO EIA-418.
  2. CONTROLLING DIMENSION: MILLIMETER.
  3. DIMENSION MEASURED @ HUB.
  4. INCLUDES FLANGE DISTORTION @ OUTER EDGE.

Data and specifications subject to change without notice.  
This product has been designed and qualified for the industrial market.  
Qualification Standards can be found on IR's Web site.

International  
**IR** Rectifier

IR WORLD HEADQUARTERS: 233 Kansas St., El Segundo, California 90245, USA Tel: (310) 252-7105  
TAC Fax: (310) 252-7903

Visit us at [www.irf.com](http://www.irf.com) for sales contact information. 4/04  
[www.irf.com](http://www.irf.com)

Note: For the most current drawings please refer to the IR website at:  
<http://www.irf.com/package/>