



ISOMAX



Global ISO Valves Platform

*Catalogue: PDE2589TCUK-ca
Edition: April 2007*



ISO specification.....	3 - 5
Selecting guide.....	6 - 7

Isomax

Highlight.....	8 - 9
Flow characteristic / Material.....	10 - 11
Order Key	12 - 18

ISYS

Highlight.....	19 - 21
Flow characteristic / Material.....	22 - 23
Order Key	24 - 33

Subbase, Manifolds, Sandwich Modules	34 - 45
--	---------

ISYS Net

Highlight.....	46 - 49
Order Key	50 - 51

Solenoids.....	52 - 57
----------------	---------

Connectors.....	58 - 59
-----------------	---------

Dimension.....	60 - 66
----------------	---------



Important !
 Before carrying out any service work, ensure that the valve and manifold have been vented. Remove the primary supply air hose to ensure total disconnection of the air supply before dismantling valves or blank connection blocks.



NB !
 All technical data in this catalogue is typical only. The air quality is decisive for the valve life: see ISO 8573.



WARNING

FAILURE OR IMPROPER SELECTION OR IMPROPER USE OF THE PRODUCTS AND/OR SYSTEMS DESCRIBED HEREIN OR RELATED ITEMS CAN CAUSE DEATH, PERSONAL INJURY AND PROPERTY DAMAGE.
 This document and other information from Parker Hannifin Corporation, its subsidiaries and authorized distributors provide product and/or system options for further investigation by users having technical expertise. It is important that you analyze all aspects of your application and review the information concerning the product or system in the current product catalog. Due to the variety of operating conditions and applications for these products or systems, the user, through its own analysis and testing, is solely responsible for making the final selection of the products and systems and assuring that all performance, safety and warning requirements of the application are met. The products described herein, including without limitation, product features, specifications, designs, availability and pricing, are subject to change by Parker Hannifin Corporation and its subsidiaries at any time without notice.

SALE CONDITIONS

The items described in this document are available for sale by Parker Hannifin Corporation, its subsidiaries or its authorized distributors. Any sale contract entered into by Parker will be governed by the provisions stated in Parker's standard terms and conditions of sale (copy available upon request).

ISO Specifications



5599-1



ISO 5599-1

External electrical connection subbase valves

The ISO Standard 5599-1 specifies an interface pattern for a common subbase valve consisting of pressure passages 1, 3, 5, 2 & 4 and pilot passages 12 & 14. The width of the pattern and location of the 4 bolt holes are also specified. There are no specifications for the type of external electrical connection used to control the valve.

Size : 1 2 3



5599-2



ISO 5599-2

Body-to-base plug-in subbase valves

Same as 5599-1 for pneumatic pressure passages, 5599-2 standard also specifies a plug-in electrical connection.

Sizes : 1 2 3

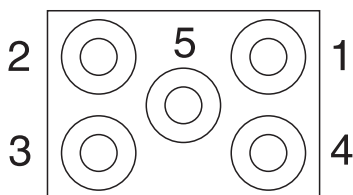

- 1 = 12 solenoid
- 2 = 14 solenoid
- 3 = 12 solenoid
- 4 = 14 solenoid
- 5 = Ground

ISO Specifications



15407-1

(VDMA 24563)



ISO 15407-1

External electrical connection subbase valves

The ISO Standard 15407-1 specifies an interface pattern for a common subbase valve consisting of pressure passages 1, 3, 5, 2 & 4 and pilot passages 12 & 14. The width of the pattern and location of the 4 bolt holes are also specified. There are no specifications for the type of external electrical connection used to control the valve.

Size : 02 01



15407-2



ISO 15407-2

Body-to-base plug-in subbase valves

Same as 15407-1 for pneumatic pressure passages, 15407-2 standard also specifies a plug-in electrical connection.

Size : 01 02

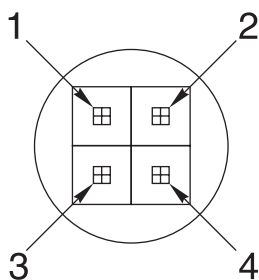

- Pin 1 = 14 solenoid
- Pin 2 = 12 solenoid
- Pin 3 = Ground +
- Pin 4 = Common -

ISO Specifications

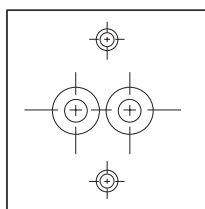

CNOMO 06-05-01

The solenoid pilot interface often used with ISO 5599-1 valves is the CNOMO interface. The CNOMO interface specifies the pressure and actuator port, and the screw holes for the mounting of this solenoid pilot. It is commonly used in European automotive plants, and its usage is becoming more prevalent for industrial ISO 5599-1 valves.

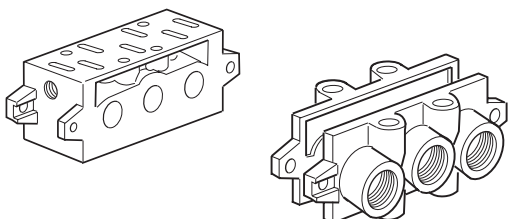

VDMA 24345

The VDMA 24345 is a standard for Manifolds and Subbase specifying a common base mounting footprint in addition to ISO 5599-1 Interface standard. (VDMA is a German organisation - Verband Deutscher Maschinen und Anlagen-Bauer - which is translated to Federation of German Machine and Unit Builders.)

Choice of components for air supply to cylinders

In the chart below can you find the suitable valves, tubes etc. for each cylinder size. If you have a tube length over 2 m, choose one tube size larger than in the chart.

Following data is valid:
 Supply pressure: min 7,0 bar
 Regulator pressure setting: 6,0 bar
 Pipe length between air treatment unit and valve: max 1 m
 Pipe length between valve and cylinder : max 2 m

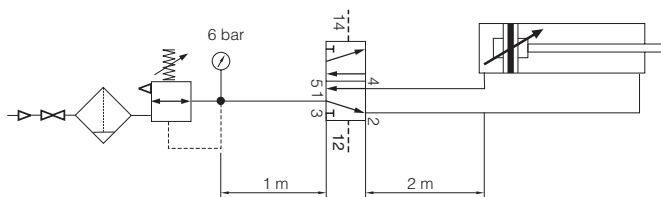







Cylinder bore	<Ø20	Ø20-32	Ø40-50	Ø63	Ø80	Ø100	Ø125	Ø160	Ø200
Cylinder port	M5	G1/8	G1/4	G3/8	G3/8	G1/2	G1/2	G3/4	G3/4
Tubing Ext / Int	4 / 2.7	6 / 4	8 / 6	10 / 7	10 / 7 12 / 9	12 / 9 14 / 11	14 / 11	18 / 15	20 / 18
Size 02	Isomax	G1/8	G1/8	G1/8	G1/8				
	ISYS	G1/8	G1/8	G1/8	G1/8	G1/8			
Size 01	Isomax	G1/4	G1/4	G1/4	G1/4	G1/4			
	ISYS	G1/4	G1/4	G1/4	G1/4	G1/4	G1/4		
Size 1	Isomax	G1/4	G1/4	G1/4	G1/4	G1/4	G1/4		
	ISYS	G1/4	G1/4	G1/4	G1/4	G1/4	G1/4		
	ISYS			G3/8	G3/8	G3/8	G3/8	G3/8	
Size 2	Isomax			G3/8	G3/8	G3/8	G3/8	G3/8	
	ISYS			G3/8	G3/8	G3/8	G3/8	G3/8	
	ISYS				G1/2	G1/2	G1/2	G1/2	G1/2
Size 3	Isomax				G1/2	G1/2	G1/2	G1/2	G1/2
	ISYS				G1/2	G1/2	G1/2	G1/2	G1/2
	ISYS					G3/4	G3/4	G3/4	G3/4



Cylinder speed < 0.5 m/s
 Cylinder speed < 1 m/s
 Cylinder speed > 1 m/s

ISO 15407

Size 02 / 01

Cylinders from Ø 10 to 100









ISO 15407-1	Individual Connection	DIN C	Isomax  Page 13	
		M12	ISYS ISO  Page 25	
		Remote pilot	Isomax  Page 14	ISYS ISO  Page 25
		Subbase Manifolds	 Page 34	
		Flow Control Regulator	 Page 42	



ISO 15407-2	Plug-in	Plug-in	ISYS ISO  Page 27	
		Subbase Manifolds	 Page 36	
		Flow Control Regulator	 Page 42	

ISO 5599

Size 1 / 2 / 3

Cylinders from Ø 63 to 200

ISO 5599-1	Individual Connection	DIN A Industrial	<div style="border: 1px solid black; padding: 5px;"> <p>Isomax</p>  <p>Page 16</p> </div>	<div style="border: 1px solid black; padding: 5px;"> <p>ISYS ISO</p>  <p>Page 29</p> </div>
		M12, M23	<div style="border: 1px solid black; padding: 5px;"> <p>Isomax</p>  <p>Page 18</p> </div>	<div style="border: 1px solid black; padding: 5px;"> <p>ISYS ISO</p>  <p>Page 31</p> </div>
		Remote pilot	<div style="border: 1px solid black; padding: 5px;"> <p>Isomax</p>  <p>Page 17</p> </div>	<div style="border: 1px solid black; padding: 5px;"> <p>ISYS ISO</p>  <p>Page 31</p> </div>
		Subbase Manifolds	<div style="border: 1px solid black; padding: 5px; text-align: center;">  <p>Page 38</p> </div>	
		Flow Control Regulator	<div style="border: 1px solid black; padding: 5px; text-align: center;">  <p>Page 44</p> </div>	

ISO 5599-2	Plug-in	Plug-in	<div style="border: 1px solid black; padding: 5px;"> <p>ISYS ISO</p>  <p>Page 33</p> </div>
		Subbase Manifolds	<div style="border: 1px solid black; padding: 5px; text-align: center;">  <p>Page 40</p> </div>
		Flow Control Regulator	<div style="border: 1px solid black; padding: 5px; text-align: center;">  <p>Page 44</p> </div>

Isomax - General Applications

Market Application

- Automotive Handling
- Packaging
- Manufacturing
- General application



Ceramic technology

All ISOMAX products use high-tech ceramic switching technology :

- **Excellent reliability :**

Long life in excess of 100 million operations*.
Operates with lubricated or non lubricated air.
Low sensitivity to air quality changes ;
switching without seal.
Stiction free.

- **Size 02 & Size 01**

Solenoid exhaust pilot

- **High performances :**

Slide valve concept allows high flow / size ratio and short response time due to short slide stroke and low friction.

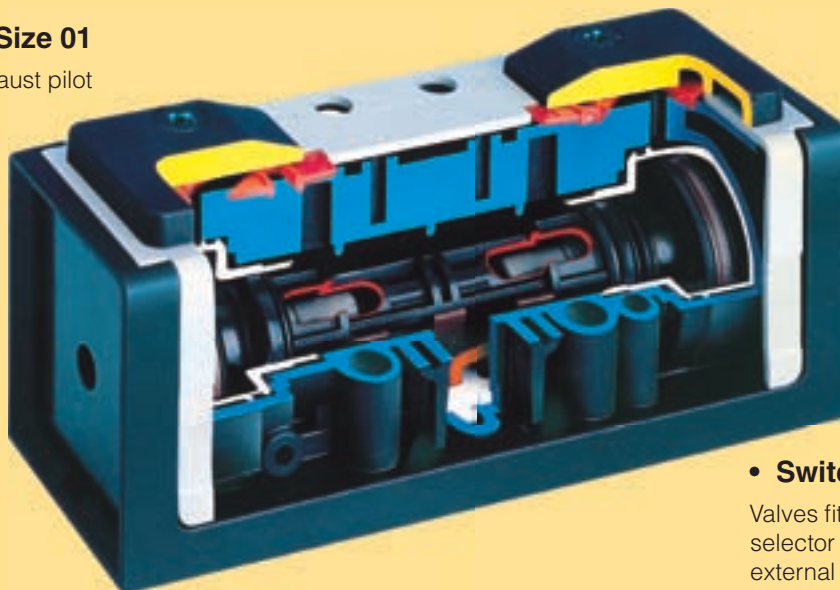

- **Switchable selector**

Valves fitted with switchable selector to give internal or external pilot supply

- **Stable long lasting performances**

Low friction switching : minimum wear of the valve member/seal assembly.

Ceramic plate



Global ISO Series Valves

Rust and corrosion resistant body

With the valve body in polyamide reinforced fiberglass and the casting in anodised aluminium, the Isomax range presents a comprehensive modern design to suit most industrial environments.

Central M12 connection or M12 coil

All sizes of ISO 5599-1 are supplied with central M12 integrated connector, a M12 bridge cable or with a 30 x 30mm coil having M12 interface.

External supply selection

In order to use actuator with low pressure, it is possible to connect an external pressure on port 14 to supply both solenoids. Selection is easily made by reversing the gasket under the operator.

High reliability

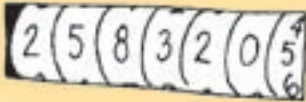

Valves easily comply with the requirements for the component reliability in accordance with EU Machinery Directive standards EN292-2 and EN983.

Maintenance

Spares are not required for the main valve or spool but solenoid operators can be replaced if required.

Manual Override

Solenoids are available with locking or non-locking manual overrides so that valves can be operated when the electrical supply is turned off.

Solenoid valves, CNOMO interface, 15mm solenoid



The standard valve is fitted with a 30mm solenoid having DIN 43650 Industrial form A connector for sizes 1, 2 and 3 15mm solenoid for sizes 01 and 02.

Low noise level

Size 01 and 02 valves fitted with the 15mm solenoid option use captured pilot exhaust which is channelled through the valve body and exhausts to atmosphere through channel 12

High electrical encapsulation class



The solenoid valves are protected to IP65 with the standard cable plug. Available with DIN A or M12 connection.

Wide choice of solenoid connectors/cable plugs

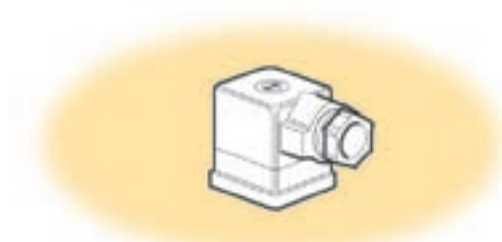

Solenoid connectors are available with or without LED and rectifier and may be selected fitted pre-wired with flying leads.

Valves having ATEX approval

ATEX approved options are available for use in explosive atmospheres. Consult our Technical Sales Department for further information.

Bottom or side ported manifold

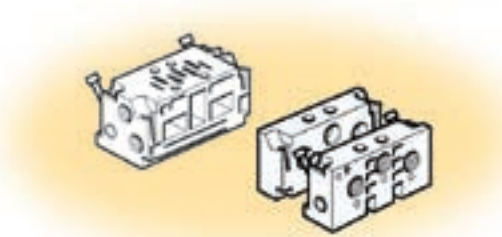

Manifolds with common ducts for ports 1,3 and 5, outlet port 2 and 4, and supply port for 12 and 14 are available side or bottom ported. Those manifolds are common for Isomax and Isys Iso.

Subbase installation VDMA

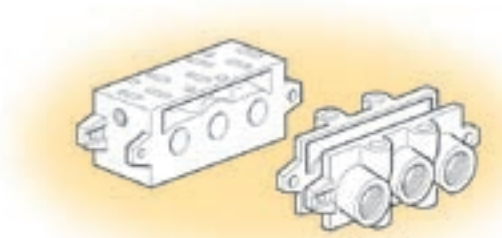

A large range of subbase, VDMA or not VDMA, bottom or side ported.



Isomax Flow Characteristics

Flow capacities in accordance with ISO6358, for 5/2 function. 5/3 function are around 10 to 20% less.

Technical Data Isomax Size 02

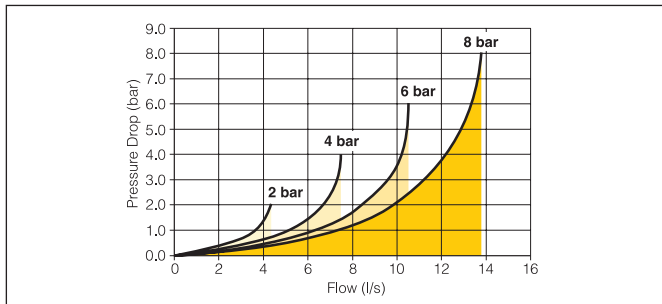

Operating pressure.	
5/2 Spring return	2,5 - 10 bar
5/2 Double solenoid	1,0 - 10 bar
Working temperature.	
-10°C to + 60°C	
Flow (acc. to ISO 6358)	
c = 1,5 NI/s x bar	
b = 0,25	
Qn = 6,3 l/s	
Qmax = 10,6 l/s	

Technical Data Isomax Size 01

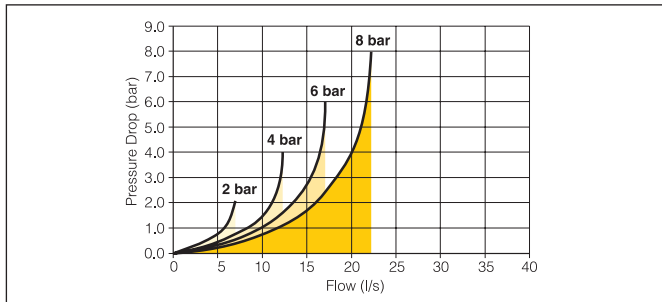

Operating pressure.	
5/2 Spring return	2,5 - 10 bar
5/2 Double solenoid	1,0 - 10 bar
Working temperature.	
-10°C to + 60°C	
Flow (acc. to ISO 6358)	
c = 2,5 NI/s x bar	
b = 0,25	
Qn = 9,8 l/s	
Qmax = 17,1 l/s	

Technical Data Isomax Size 1

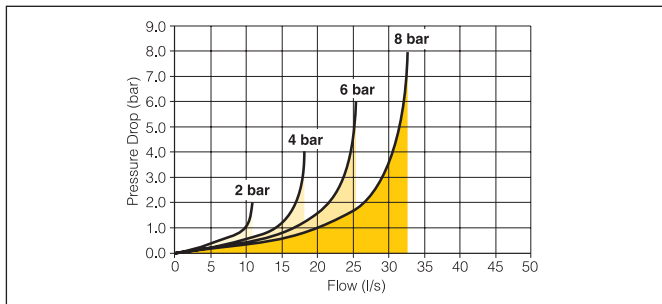

Operating pressure.	
5/2 Spring return	2,5 - 10 bar
5/2 Double solenoid	1,0 - 10 bar
Pneumatic version	
12 bar	
Working temperature.	
-10°C to + 60°C	
Flow (acc. to ISO 6358)	
c = 3,8 NI/s x bar	
b = 0,35	
Qn = 17,2 l/s	
Qmax = 25,5 l/s	

Technical Data Isomax Size 2

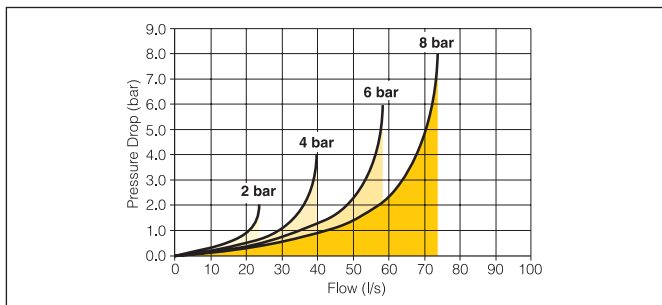

Operating pressure.	
5/2 Spring return	2,0 - 10 bar
5/2 Double solenoid	1,0 - 10 bar
Pneumatic version	
12 bar	
Working temperature.	
-10°C to + 60°C	
Flow (acc. to ISO 6358)	
c = 8,2 NI/s x bar	
b = 0,35	
Qn = 38,3 l/s	
Qmax = 58,7 l/s	

Technical Data Isomax Size 3

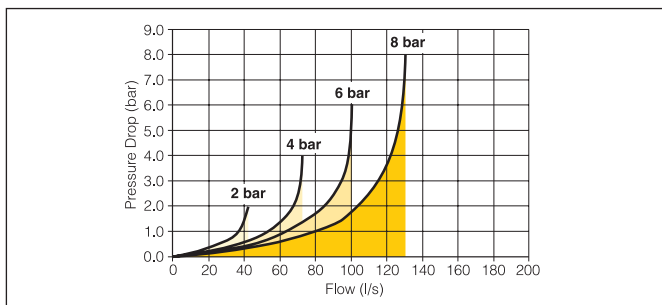

Operating pressure.	
5/2 Spring return	2,0 - 10 bar
5/2 Double solenoid	1,0 - 10 bar
Pneumatic version	
12 bar	
Working temperature.	
-10°C to + 60°C	
Flow (acc. to ISO 6358)	
c = 14,5 NI/s x bar	
b = 0,35	
Qn = 64,0 l/s	
Qmax = 101,0 l/s	



Isomax Material Specification and Characteristics

15407

Valve member - seat :	Self lubricating acetal - ceramic
Body :	Polyamide reinforced fibreglass
Casing - End plates :	Anodised aluminium - Painted zinc plated steel
Valve plate :	Zamak
Seals :	Nitrile
Springs :	Stainless steel
Screws :	Zinc plated steel
Function selector :	
Top cover - Seal :	Polyamide reinforced fiberglass - Polyester

Characteristics

Fluid:	Air or inert gas filtered 40u class 5 according to ISO 8573-1 dry class 4 according to ISO 8573-1 non-lubricated, or lubricated
Storage temperature	-20° to + 70°
Vibration	according to IEC 68-2-6 2G 2 to 150Hz
Shock	according to IEC 68-2-7 15G 11ms
Manual override	Non-locking, other type on request
Solenoid : please see page xx	

Certification

EMC / CE mark.	According to EN 61 000-6-2
Dust & water protection	IP65 according to EN 60529

5599

Valve member - seat :	Self lubricating acetal - ceramic
Body :	Polyamide reinforced fibreglass
Casing - End plates :	Anodised aluminium - Painted zinc plated steel
Valve plate :	Zamak
Seals :	Nitrile
Springs :	Stainless steel
Screws :	Zinc plated steel
Function selector :	
Top cover - Seal :	Polyamide reinforced fiberglass - Polyester

Characteristics

Fluid:	Air or inert gas filtered 40u class 5 according to ISO 8573-1 dry class 4 according to ISO 8573-1 non-lubricated, or lubricated
Storage temperature	-20° to + 70°
Vibration	according to IEC 68-2-6 2G 2 to 150Hz
Shock	according to IEC 68-2-7 15G 11ms
Manual override	Non-locking, other type on request
Solenoid : please see page xx	

Certification

EMC / CE mark.	According to EN 61 000-6-2
Dust & water protection	IP65 according to EN 60529

Isomax - ISO 15407 - 15mm Solenoid

Order chart

DX	01 - 6	21 - 95	1	M	S
-----------	---------------	----------------	----------	----------	----------

Size	
02	18 mm (ISO 15407)
01	26 mm (ISO 15407)

Pilot	
4	Pneumatic
6	Electro-Pneumatic

Valve type function	
Internal pilot supply / Capture exhaust 12	
06	5/2 double solenoid
56	5/2 double solenoid, 14 prioritised
21	5/2 single solenoid, spring return
51	5/2 single solenoid, differential return
11	5/3 double solenoid vented centre
16	5/3 double solenoid closed centre
13	5/3 double solenoid pressurised center
External pilot 14 supply / Capture exhaust 12	
05	5/2 double solenoid
59	5/2 double solenoid, 14 prioritised
23	5/2 single solenoid, spring return
54	5/2 single solenoid, differential return
09	5/3 double solenoid vented centre
19	5/3 double solenoid closed centre
14	5/3 double solenoid pressurised center

Voltage	
B	12 V AC
C	24 V AC
D	48 V AC
J	110 V AC
A	230 V AC
L	12 V DC
M	24 V DC
N	48 V DC

Manual override	
0	Without any
1	Flush non locking
3	Flush locking
2	Flush non locking (extended 15 mm)
5	Flush locking (extended 15 mm)

Electrical operator	
60	Without any *
95	15 mm solenoid 1,2 W DIN 43650 form C †

* Standard for Pneumatic version
† Standard for electro-pneumatic version



Connector	
Without any	
C	Standard connector
S	Connector with LED and protection
S3	Connector with LED and protection - 3 m cable
S5	Connector with LED and protection - 5 m cable

Shaded part numbers are standard

Isomax

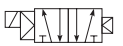
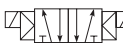

Solenoid operated ISO valve fitted with 15 mm solenoid 24 VDC

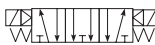
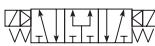
Solenoid plug/connector to be ordered separately. See page 58



Symbol	Size	Actuation	Return	Signal pressure min. (bar) at 6 bar actua./return	Changeover time (ms) at 6 bar actua./return	Weight Kg	Order code
5/2 Valves							
	02 - 18mm	Electrical signal	Spring	4,0/2,0	15/25	0.13	DX02-621-951M
	01 - 26mm	Electrical signal	Spring	4,3/2,3	25/35	0.17	DX01-621-951M
	02 - 18mm	Electrical signal	Differential	3,9/1,6	15/30	0.13	DX02-651-951M
	01 - 26mm	Electrical signal	Differential	3,8/1,7	20/40	0.17	DX01-651-951M
	02 - 18mm	Electrical signal	Electrical signal	1,3/1,3	12/12	0.17	DX02-606-951M
	01 - 26mm	Electrical signal	Electrical signal	1,0/1,0	15/15	0.21	DX01-606-951M
5/3 Valves							
	02 - 18mm	Electrical signal	Electrical signal	3,3	20/60	0.17	DX02-616-951M
	01 - 26mm	Closed center	Self centering	2,9	20/60	0.21	DX01-616-951M
	02 - 18mm	Electrical signal	Electrical signal	3,3	20/60	0.17	DX02-611-951M
	01 - 26mm	Vented center	Self centering	3	20/60	0.21	DX01-611-951M
	02 - 18mm	Electrical signal	Electrical signal	3,3	20/60	0.17	DX02-613-951M
	01 - 26mm	Press. center	Self centering	3	20/60	0.21	DX01-613-951M

Solenoid operated ISO valve fitted with adaptor to accept 15 mm solenoid

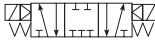
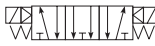
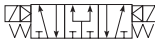
Solenoid plug/connector to be ordered separately. See pages 54 & 58

Symbol	Size	Actuation	Return	Signal pressure min. (bar) at 6 bar actua./return	Changeover time (ms) at 6 bar actua./return	Weight Kg	Order code
5/2 Valves							
	02 - 18mm	Electrical signal	Spring	4,0/2,0	15/25	0.9	DX02-621-60
	01 - 26mm	Electrical signal	Spring	4,3/2,3	25/35	0.13	DX01-621-60
	02 - 18mm	Electrical signal	Differential	3,9/1,6	15/30	0.9	DX02-651-60
	01 - 26mm	Electrical signal	Differential	3,8/1,7	20/40	0.13	DX01-651-60
	02 - 18mm	Electrical signal	Electrical signal	1,3/1,3	12/12	0.9	DX02-606-60
	01 - 26mm	Electrical signal	Electrical signal	1,0/1,0	15/15	0.13	DX01-606-60
5/3 Valves							
	02 - 18mm	Electrical signal	Electrical signal	3,3	20/60	0.9	DX02-616-60
	01 - 26mm	Closed center	Self centering	2,9	20/60	0.13	DX01-616-60
	02 - 18mm	Electrical signal	Electrical signal	3,3	20/60	0.9	DX02-611-60
	01 - 26mm	Vented center	Self centering	3	20/60	0.13	DX01-611-60
	02 - 18mm	Electrical signal	Electrical signal	3,3	20/60	0.9	DX02-613-60
	01 - 26mm	Press. center	Self centering	3	20/60	0.13	DX01-613-60

Pneumatic operated ISO valve

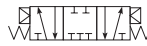
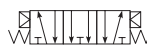
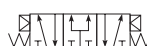
Symbol	Size	Actuation	Return	Signal pressure min. (bar) at 6 bar actua./return	Changeover time (ms) at 6 bar actua./return	Weight Kg	Order code
5/2 Valves							
	02 - 18mm 01 - 26mm	Air signal Air signal	Spring Spring	4,0/2,0 4,3/2,3	15/25 25/35	0.9 0.13	DX02-421-60 DX01-421-60
	02 - 18mm 01 - 26mm	Air signal Air signal	Differential Differential	3,9/1,6 3,8/1,7	15/30 20/40	0.9 0.13	DX02-451-60 DX01-451-60
	02 - 18mm 01 - 26mm	Air signal Air signal	Air signal Air signal	1,3/1,3 1,0/1,0	12/12 14/14	0.9 0.13	DX02-406-60 DX01-406-60
5/3 Valves							
	02 - 18mm 01 - 26mm	Air signal Closed center	Air signal Self centering	3,3 2,9	20/50 20/50	0.9 0.13	DX02-416-60 DX01-416-60
	02 - 18mm 01 - 26mm	Air signal Vented center	Air signal Self centering	3,3 3	20/50 20/50	0.9 0.13	DX02-411-60 DX01-411-60
	02 - 18mm 01 - 26mm	Air signal Press. center	Air signal Self centering	3,3 3	20/50 20/50	0.9 0.13	DX02-413-60 DX01-413-60















Isomax - ISO 5599 - Size 1 / 2 / 3 - CNOMO

Order chart

DX	1	-	6	51	-	B	L	49
-----------	----------	----------	----------	-----------	----------	----------	----------	-----------

Size	
1	Size 1 (ISO 5599)
2	Size 2 (ISO 5599)
3	Size 3 (ISO 5599)

Pilot	
4	Pneumatic
6	Electro-Pneumatic

Valve type function		
Internal pilot supply		
06		5/2 double solenoid
56		5/2 double solenoid, 14 prioritised
21		5/2 single solenoid, spring return
51		5/2 single solenoid, differential return
11		5/3 double solenoid vented centre
16		5/3 double solenoid closed centre
13		5/3 double solenoid pressurised center
External pilot 14 supply		
05		5/2 double solenoid
59		5/2 double solenoid, 14 prioritised
23		5/2 single solenoid, spring return
54		5/2 single solenoid, differential return
09		5/3 double solenoid vented centre
19		5/3 double solenoid closed centre
14		5/3 double solenoid pressurised center

Voltage		
	DC	AC
45	12	
49	24	
40		12
42		24
53		110
57		230
Blank	Valve less coil	

Solenoid enclosure	
2*	Central M12 connection
6*	M12 on each coil
L	3 pin 30mm DIN 43650A
P	3 pin Industrial form B
N	Valve less coil

*19 for M12 coil

Overrides	
60	Remote pilot / without solenoid
70	Remote pilot / without solenoid *
A	No override
B	Non-locking (single sol.) Flush - Metal
C	Locking (double sol.) Flush - Plastic

* Fitted with direct spool override.





Shaded part numbers are standard



Isomax



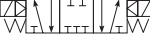

Solenoid operated ISO valve fitted with CNOMO solenoid(s) 24 VDC

Solenoid plug/connector to be ordered separately. See page 58

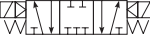
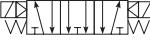

Symbol	Size	Actuation	Return	Signal pressure min. (bar) at 6 bar actua./return	Changeover time (ms) at 6 bar actua./return	Weight Kg	Order code
5/2 Valves							
	1 - 43mm	Electrical signal	Spring	3,9/2,5	40/55	0.5	DX1-621-BL49
	2 - 56mm	Electrical signal	Spring	3,6/2,4	60/105	0.75	DX2-621-BL49
	3 - 71mm	Electrical signal	Spring	3,6/2,3	85/160	1.25	DX3-621-BL49
	1 - 43mm	Electrical signal	Differential	3,3/1,9	30/70	0.5	DX1-651-BL49
	2 - 56mm	Electrical signal	Differential	3,3/2,0	55/110	0.75	DX2-651-BL49
	3 - 71mm	Electrical signal	Differential	3,3/1,9	80/180	1.25	DX3-651-BL49
	1 - 43mm	Electrical signal	Electrical signal	1,0/1,0	25/25	0.65	DX1-606-BL49
	2 - 56mm	Electrical signal	Electrical signal	1,0/1,0	30/30	0.9	DX2-606-BL49
	3 - 71mm	Electrical signal	Electrical signal	1,0/1,0	40/40	1.4	DX3-606-BL49
5/3 Valves							
	1 - 43mm	Electrical signal	Electrical signal	2,6	30/95	0.65	DX1-616-BL49
	2 - 56mm	Closed center	Self centering	2,1	40/190	0.9	DX2-616-BL49
	3 - 71mm			2,1	55/330	1.4	DX3-616-BL49
	1 - 43mm	Electrical signal	Electrical signal	2,8	25/70	0.65	DX1-611-BL49
	2 - 56mm	Vented center	Self centering	2,2	40/140	0.9	DX2-611-BL49
	3 - 71mm			2,1	60/270	1.4	DX3-611-BL49
	1 - 43mm	Electrical signal	Electrical signal	2,4	25/65	0.65	DX1-613-BL49
	2 - 56mm	Press. center	Self centering	2,1	40/150	0.9	DX2-613-BL49

Solenoid operated ISO valve fitted with CNOMO operator without coil

Solenoid plug/connector to be ordered separately. See page 57



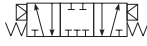
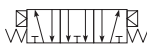
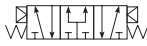

Symbol	Size	Actuation	Return	Signal pressure min. (bar) at 6 bar actua./return	Changeover time (ms) at 6 bar actua./return	Weight Kg	Order code
5/2 Valves							
	1 - 43mm	Electrical signal	Spring	3,9/2,5	40/55	0.4	DX1-621-BN
	2 - 56mm	Electrical signal	Spring	3,6/2,4	60/105	0.65	DX2-621-BN
	3 - 71mm	Electrical signal	Spring	3,6/2,3	85/160	1.15	DX3-621-BN
	1 - 43mm	Electrical signal	Differential	3,3/1,9	30/70	0.4	DX1-651-BN
	2 - 56mm	Electrical signal	Differential	3,3/2,0	55/110	0.65	DX2-651-BN
	3 - 71mm	Electrical signal	Differential	3,3/1,9	80/180	1.15	DX3-651-BN
	1 - 43mm	Electrical signal	Electrical signal	1,0/1,0	25/25	0.55	DX1-606-BN
	2 - 56mm	Electrical signal	Electrical signal	1,0/1,0	30/30	0.8	DX2-606-BN
	3 - 71mm	Electrical signal	Electrical signal	1,0/1,0	40/40	1.3	DX3-606-BN
5/3 Valves							
	1 - 43mm	Electrical signal	Electrical signal	2,6	30/95	0.55	DX1-616-BN
	2 - 56mm	Closed center	Self centering	2,1	40/190	0.8	DX2-616-BN
	3 - 71mm			2,1	55/330	1.3	DX3-616-BN
	1 - 43mm	Electrical signal	Electrical signal	2,8	25/70	0.55	DX1-611-BN
	2 - 56mm	Vented center	Self centering	2,2	40/140	0.8	DX2-611-BN
	3 - 71mm			2,1	60/270	1.3	DX3-611-BN
	1 - 43mm	Electrical signal	Electrical signal	2,4	25/65	0.55	DX1-613-BN
	2 - 56mm	Press. center	Self centering	2,1	40/150	0.8	DX2-613-BN

Pneumatic operated ISO valve without valve spool override

Symbol	Size	Actuation	Return	Signal pressure min. (bar) at 6 bar actua./return	Changeover time (ms) at 6 bar actua./return	Weight Kg	Order code
5/2 Valves							
	1 - 43mm	Air signal	Spring	3,9/2,5	30/45	0.35	DX1-421-60
	2 - 56mm	Air signal	Spring	3,6/2,4	50/95	0.6	DX2-421-60
	3 - 71mm	Air signal	Spring	3,6/2,3	80/160	1.1	DX3-421-60
	1 - 43mm	Air signal	Differential	3,3/1,9	25/60	0.35	DX1-451-60
	2 - 56mm	Air signal	Differential	3,3/2,0	45/100	0.6	DX2-451-60
	3 - 71mm	Air signal	Differential	3,3/1,9	70/170	1.1	DX3-451-60
	1 - 43mm	Air signal	Air signal	1,0/1,0	20/20	0.35	DX1-406-60
	2 - 56mm	Air signal	Air signal	1,0/1,0	25/25	0.6	DX2-406-60
	3 - 71mm	Air signal	Air signal	1,0/1,0	35/35	1.1	DX3-406-60
5/3 Valves							
	1 - 43mm	Air signal	Air signal	2,6	20/80	0.35	DX1-416-60
	2 - 56mm	Closed center	Self centering	2,1	30/170	0.6	DX2-416-60
	3 - 71mm			2,1	45/330	1.1	DX3-416-60
	1 - 43mm	Air signal	Air signal	2,8	20/65	0.35	DX1-411-60
	2 - 56mm	Vented center	Self centering	2,2	30/140	0.6	DX2-411-60
	3 - 71mm			2,1	50/270	1.1	DX3-411-60
	1 - 43mm	Air signal	Air signal	2,4	20/60	0.35	DX1-413-60
	2 - 56mm	Press. center	Self centering	2,1	25/140	0.6	DX2-413-60



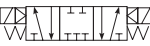

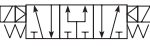
Solenoid operated ISO valve, CNOMO, 24 VDC with M12 coil

M12 connection is integrated on the coil, Led & surge suppressor

Symbol	Size	Actuation	Return	Signal pressure min. (bar) at 6 bar actua./return	Changeover time (ms) at 6 bar actua./return	Weight Kg	Order code
5/2 Valves							
	1 - 43mm	Electrical signal	Spring	3,9/2,5	40/55	0.5	DX1-621-B619
	2 - 56mm	Electrical signal	Spring	3,6/2,4	60/105	0.75	DX2-621-B619
	3 - 71mm	Electrical signal	Spring	3,6/2,3	85/160	1.25	DX3-621-B619
	1 - 43mm	Electrical signal	Differential	3,3/1,9	30/70	0.5	DX1-651-B619
	2 - 56mm	Electrical signal	Differential	3,3/2,0	55/110	0.75	DX2-651-B619
	3 - 71mm	Electrical signal	Differential	3,3/1,9	80/180	1.25	DX3-651-B619
	1 - 43mm	Electrical signal	Electrical signal	1,0/1,0	25/25	0.65	DX1-606-B619
	2 - 56mm	Electrical signal	Electrical signal	1,0/1,0	30/30	0.9	DX2-606-B619
	3 - 71mm	Electrical signal	Electrical signal	1,0/1,0	40/40	1.4	DX3-606-B619
5/3 Valves							
	1 - 43mm	Electrical signal	Electrical signal	2,6	30/95	0.65	DX1-616-B619
	2 - 56mm	Closed center	Self centering	2,1	40/190	0.9	DX2-616-B619
	3 - 71mm			2,1	55/330	1.4	DX3-616-B619
	1 - 43mm	Electrical signal	Electrical signal	2,8	25/70	0.65	DX1-611-B619
	2 - 56mm	Vented center	Self centering	2,2	40/140	0.9	DX2-611-B619
	3 - 71mm			2,1	60/270	1.4	DX3-611-B619
	1 - 43mm	Electrical signal	Electrical signal	2,4	25/65	0.65	DX1-613-B619
	2 - 56mm	Press. center	Self centering	2,1	40/150	0.9	DX2-613-B619

Solenoid operated ISO valve, CNOMO, 24 VDC with Din A coil and M12 connector

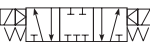
M12 connection is made with an adaptor between coils, Led & surge suppressor

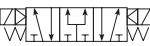
Symbol	Size	Actuation	Return	Signal pressure min. (bar) at 6 bar actua./return	Changeover time (ms) at 6 bar actua./return	Weight Kg	Order code
5/2 Valves							
	1 - 43mm	Electrical signal	Spring	3,9/2,5	40/55	0.65	DX1-621-B219
	2 - 56mm	Electrical signal	Spring	3,6/2,4	60/105	0.9	DX2-621-B219
	3 - 71mm	Electrical signal	Spring	3,6/2,3	85/160	1.4	DX3-621-B219
	1 - 43mm	Electrical signal	Differential	3,3/1,9	30/70	0.65	DX1-651-B219
	2 - 56mm	Electrical signal	Differential	3,3/2,0	55/110	0.9	DX2-651-B219
	3 - 71mm	Electrical signal	Differential	3,3/1,9	80/180	1.4	DX3-651-B219
	1 - 43mm	Electrical signal	Electrical signal	1,0/1,0	25/25	0.8	DX1-606-B219
	2 - 56mm	Electrical signal	Electrical signal	1,0/1,0	30/30	1.05	DX2-606-B219
	3 - 71mm	Electrical signal	Electrical signal	1,0/1,0	40/40	1.55	DX3-606-B219
5/3 Valves							
	1 - 43mm	Electrical signal	Electrical signal	2,6	30/95	0.8	DX1-616-B219
	2 - 56mm	Closed center	Self centering	2,1	40/190	1.05	DX2-616-B219
	3 - 71mm			2,1	55/330	1.55	DX3-616-B219
	1 - 43mm	Electrical signal	Electrical signal	2,8	25/70	0.8	DX1-611-B219
	2 - 56mm	Vented center	Self centering	2,2	40/140	1.05	DX2-611-B219
	3 - 71mm			2,1	60/270	1.55	DX3-611-B219
	1 - 43mm	Electrical signal	Electrical signal	2,4	25/65	0.8	DX1-613-B219
	2 - 56mm	Press. center	Self centering	2,1	40/150	1.05	DX2-613-B219

ISYS ISO - Heavy Duty Applications

Market Applications

- Automotive
- Machine tools
- Mobile



- **Stable long lasting performances :**

due to wear compensation

- **Excellent reliability :**

Long life in excess of 30 million operations.

- **Heavy Duty Metal Body**

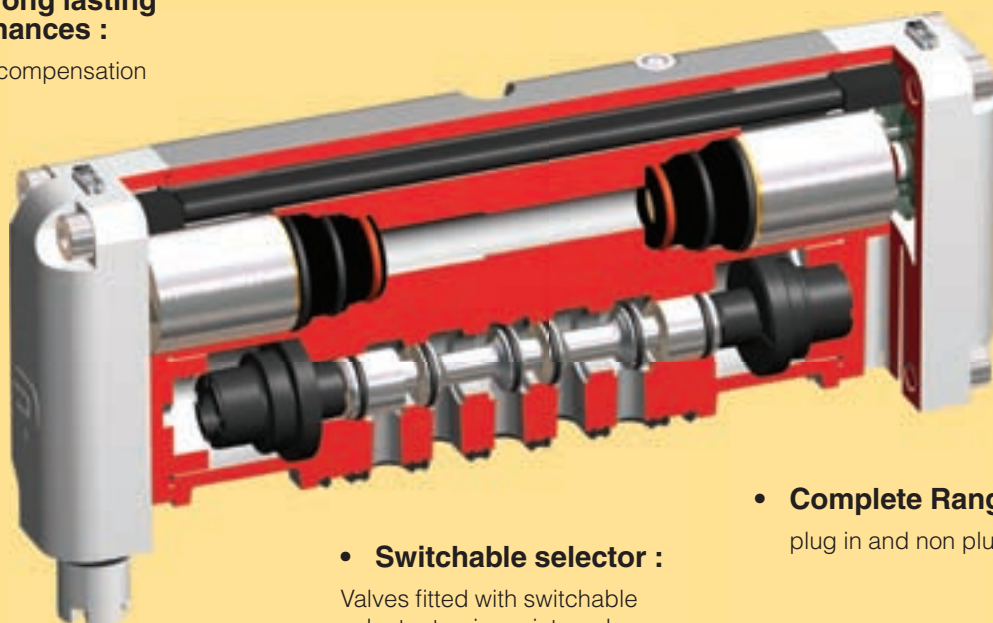

- **Complete Range :**

plug in and non plug in

- **Switchable selector :**

Valves fitted with switchable selector to give internal or external pilot supply

- **WCS Spool Technology**

WCS
Wear Compensating System

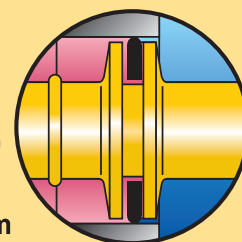

ISYS ISO Features

Complete ISO valve range

ISO 15407-1, ISO 15407-2, ISO 5599-1, ISO 5599-2, ISO 4400 DIN A, 12mm, 23 mm, multipole and centralized fieldbus are all feature of ISYS ISO valve.

Heavy duty and corrosion resistant body

with a valve body made of painted die casted aluminium and polyamide reinforced glassfiber caps, Isys Iso are suitable for heavy duty environment

External supply selection

In order to use actuator with low pressure, it is possible to connect an external pressure on port 14 to supply both solenoids. Selection is easily made by reversing the gasket under the operator.

High reliability



Valves comply with the requirements for the component reliability in accordance with EU Machinery Directive standards EN292-2 and EN983.

Mobile applications

ISYS ISO range could be fit with a metal mobile CNOMO solenoid. Available with different coil voltages, allowing +/- 30% voltage tolerance, operating from -15°C to 50°C, under demanding vibration and shock condition, ISYS ISO is suitable for mobile and railway applications.

Solenoid valves, CNOMO interface, integrated solenoid



The standard valve is fitted with a 30mm solenoid having DIN 43650 Industrial form A connector for sizes 1, 2 and 3. For sizes 01 and 02, the solenoid is integrated in the valve body.

Central M12 & M23 connection or M12 coil

Sizes 01 & 02 are available with a central M12 connection
Sizes 1, 2 & 3 are available with a central M12 or M23 connector, compatible with different automotive standard, but also with 30x30 coil having the M12 connection.

Internal or external led & rectifier

Sizes 01 & 02 have integrated Led and rectifier, for all connections. Sizes 1,2, 3 are available with integrated Led and rectifier in the coil or basic Din A coil.

High electrical encapsulation class



The solenoid valves are protected to IP65 with the standard cable plug. Available with DIN A or M12 connection.

Wide range of solenoid connectors / cable plugs for ISO 5599-1



Solenoid connectors are available with or without LED and rectifier and may be selected fitted pre-wired with flying leads.

Bottom or side ported manifolds and subbases

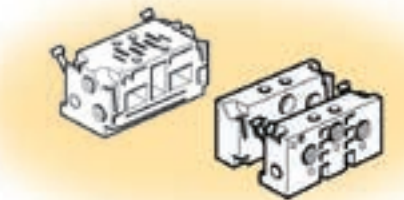

Manifolds are common for ISO 15407-1 & ISO 5599-1. A dedicated range of manifold is available for ISYS ISO with integrated electrical connection in the base (plug in)

Insensitive to dirty air

Thanks to large flow passage areas and the large flow diameter of 1.3 in the pilot valves, the ISO valve can be used in normal industrial or mobile environments without any problems of blocking. However the service life of the valve depends on the cleanliness of the air. Please refer to ISO 8573.

ISYS ISO - Features

Serial communication

ISYSNET provides an open communications protocol with a common platform that is compatible with all ISO valves. ISYSNET allows connecting with Ethernet IP, Profibus DP, ControlNet, and DeviceNet. The communication modules are IP65 protected and can be easily replaced by using latching mechanisms that eliminate the need for screws. DIP and rotary switches come standard, as well as electrical connection. A total of 63 Input / Output modules can be assembled with a single communication module node. Both digital (M8, M12, and M23 connection) and analog (current or voltage) Inputs / Outputs modules are available. Sinking (NPN) or sourcing (PNP) modules complete the connectivity solution. Built-in Diagnostic, such as open circuit, no-load, and short-circuit detection, simplify maintenance. The modules also have overvoltage protection and reverse-polarity protection.

Collective wiring

There are no wires between connectors and base circuit boards. Circuit boards make all connections throughout the manifold, decreasing opportunities for electrical failures due to loose wire. Plate cover for collective wiring has an IP65 rating. Main connector available on left end module are:

- 25 pin D-Sub connector allowing 24 solenoids
- 19 pin Brad Harrison round connector allowing 16 solenoids
- 12 pin M23 round connector allowing 8 solenoids
- 16 Point terminal strip, allowing 16 solenoids
- ISYS NET module, 32 outputs, allowing 32 solenoids

Hard wiring

In case of 110 or 230 VAC standard voltage, or for a small number of valves on the manifold, especially for sizes 2 & 3, hard wiring could be preferred. This method requires wiring each valve through a simple cable or a screw terminal.

ISO 15407-2 manifolds

Using ISO 15407 standards as foundation, the Isys line leapfrogs proprietary valves to install 18 and 26 mm valves within the same manifold.

Manifold bases are available in two-station multiple.

Two-station manifolds increase rigidity for longer manifolds and decrease the number of base-to-base electrical and pneumatic connections, reducing the potential for leaks and electrical misconnections. Cylinder ports are available with BSPP, NPT in inch sizes.

Manifold bases are available with side or side and bottom ported.

Oversize ports for ISO 5599-2 manifolds

Due to the standardized size of bases and valve, the resulting flow is limited by port size. All manifolds for size 1, 2, and 3 are available with oversize port to optimize the flow for size. As an example, size 1 valve and manifold, equipped with a 3/8 port is suitable with a 100mm diameter cylinder where a size 2 valve will have been chosen.

This is all the more true than the cylinder speed is limited with flow control and adjusted near 0,5m/s

ISYS ISO Flow Characteristics

Flow capacities in accordance with ISO6358, for 5/2 function. 5/3 function are around 10 to 20% less

Technical Data ISYS ISO Size 02

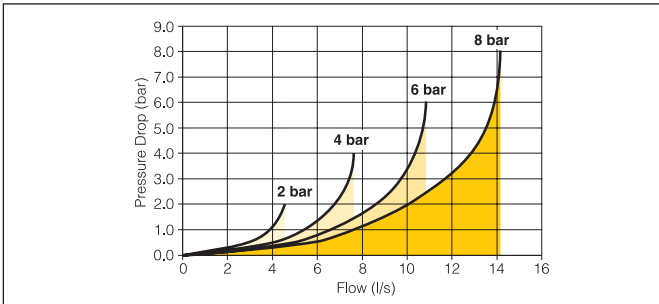

Operating pressure.	
5/2 Spring assist	2,0 - 10 bar
5/2 Double solenoid	1,7 - 10 bar
Working temperature.	
-15°C to + 50°C	
Flow (acc. to ISO 6358)	
$c = 1,5 \text{ NI/s} \times \text{bar}$	
$b = 0,25$	
$Q_n = 6,5 \text{ l/s}$	
$Q_{max} = 10,8 \text{ l/s}$	

Technical Data ISYS ISO Size 01

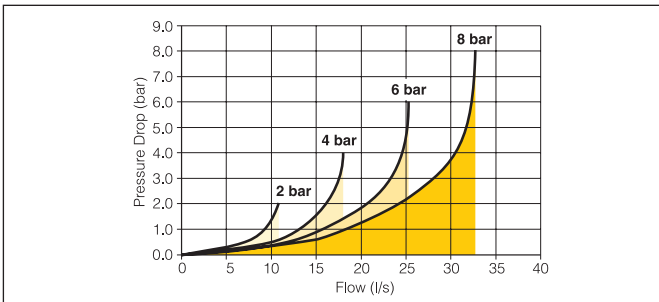

Operating pressure.	
5/2 Spring assist	2,0 - 10 bar
5/2 Double solenoid	1,7 - 10 bar
Working temperature.	
-15°C to + 50°C	
Flow (acc. to ISO 6358)	
$c = 3,6 \text{ NI/s} \times \text{bar}$	
$b = 0,30$	
$Q_n = 15,3 \text{ l/s}$	
$Q_{max} = 25,3 \text{ l/s}$	

Technical Data ISYS ISO Size 1

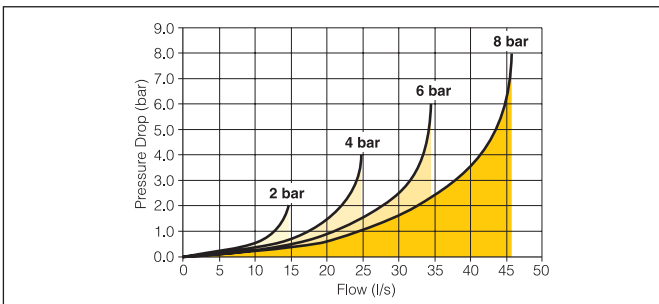

Operating pressure.	
5/2 Spring assist	2,4 - 10 bar
5/2 Double solenoid	1,7 - 10 bar
Working temperature.	
-15°C to + 50°C	
Flow (acc. to ISO 6358)	
$c = 5,0 \text{ NI/s} \times \text{bar}$	
$b = 0,30$	
$Q_n = 20,8 \text{ l/s}$	
$Q_{max} = 34,5 \text{ l/s}$	

Technical Data ISYS ISO Size 2

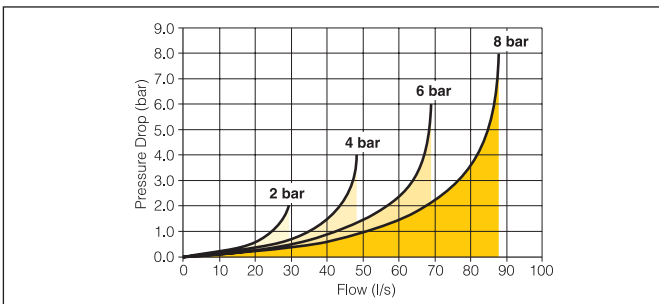

Operating pressure.	
5/2 Spring assist	3,1 - 10 bar
5/2 Double solenoid	1,7 - 10 bar
Working temperature.	
-15°C to + 50°C	
Flow (acc. to ISO 6358)	
$c = 9,7 \text{ NI/s} \times \text{bar}$	
$b = 0,35$	
$Q_n = 42,0 \text{ l/s}$	
$Q_{max} = 69,0 \text{ l/s}$	

Technical Data ISYS ISO Size 3

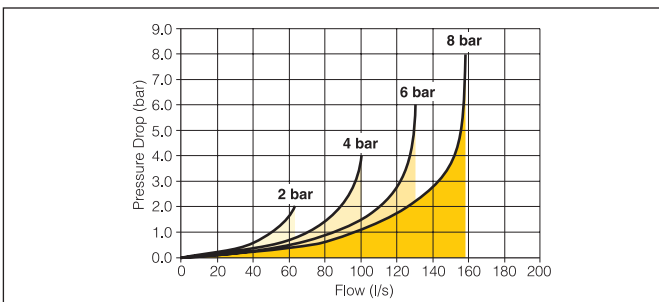

Operating pressure.	
5/2 Spring assist	3,1 - 10 bar
5/2 Double solenoid	1,7 - 10 bar
Working temperature.	
-15°C to + 50°C	
Flow (acc. to ISO 6358)	
$c = 18,7 \text{ NI/s} \times \text{bar}$	
$b = 0,35$	
$Q_n = 83,7 \text{ l/s}$	
$Q_{max} = 130,8 \text{ l/s}$	

ISYS ISO Material Specification and Characteristics

Material specification

Valve body:	Die cast aluminium
End cover:	PBT
Spool:	Aluminium + nitrile rubber
Piston:	Acetal plastic
End cover sealing:	Nitrile rubber
Fasteners:	Zinc plated steel

HA & HB Solenoids

Minimum operating voltage:	DC 20,4 V, AC 102 V
Power:	DC 1W, AC 2VA
Bi polar:	
Surge suppressor:	Standard
Light indicator:	Standard

Characteristics

Fluid:	Air, inert gas filtered 40u class 5 according to ISO 8573-1 dry class 4 according to ISO 8573-1 non-lubricated, or lubricated -20° to + 70°
Storage temperature	
Vibration, according to IEC 68-2-6	2G 2 to 150Hz
Shock, according to IEC 68-2-7	15G 11ms
Manual override	Non-locking, other type on request

Plug-in Solenoids

Minimum operating voltage:	DC 20,4 V, AC 102 V
Power:	DC 3W, AC 4,5VA
Bi polar:	
Surge suppressor:	On lighted coils
Light indicator:	Standard

Certification

CSA / C-US approved	
EMC / CE mark.	According to EN 61 000-6-2
Dust & water protection	IP65 according to EN 60529

ISYS ISO M12 and Pilot

Order chart







H	B	1	WX	B	G	2	G9	000F	A
----------	----------	----------	-----------	----------	----------	----------	-----------	-------------	----------

Size	
B	ISO 15407 - 18mm
A	ISO 15407 - 26mm

Pilot source / Pilot exhaust	
B	Internal pilot, port#1 / vented
L	External pilot#14 port / vented

Voltage	
DC	
G9	24

2	Central M12
----------	-------------

Valve type function	
1	 Single solenoid, 2 position - Differential
2	 Double solenoid, 2 position
5	 Double solenoid, 3 position - APB
6	 Double solenoid, 3 position - CE
7	 Double solenoid, 3 position - PC
E	 Single solenoid, 2 position, Differential, spring assist

Overrides	
G	Non-locking, flush, push - w/ light
H	Locking, flush, push / turn - w/ light

Shaded part numbers are standard









ISYS ISO

ISYS ISO Remote Pilot

Order chart

H	B	3	WX 000 XX A
----------	----------	----------	--------------------

Size	
B	ISO 15407 - 18mm
A	ISO 15407 - 26mm

Valve type function	
3	 Single remote pilot, 2 position - Differential
4	 Double remote pilot, 2 position
8	 Double remote pilot, 3 position - APB
9	 Double remote pilot, 3 position - CE
0	 Double remote pilot, 3 position - PC
F	 Single solenoid, 2 position, Differential, spring assist



Shaded part numbers are standard





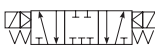
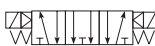
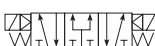

ISYS ISO

Solenoid operated ISO valve, 24VDC, central M12 connection

Oriented side 14, Led & surge suppressor

Symbol	Size	Actuation	Return	Signal pressure min. (bar) at 6 bar actua./return	Changeover time (ms) at 6 bar actua./return	Weight Kg	Order code
5/2 Valves							
	02 - 18mm	Electrical signal	Spring & Diff.	3,1	20/40	0.15	HBEXXBG2G9000FA HAEXXBG2G9000FA
	01 - 26mm	Electrical signal	Spring & Diff.	3,1	20/45	0.25	
	02 - 18mm	Electrical signal	Differential	2,7	15/40	0.15	HB1WXXBG2G9000FA HA1WXXBG2G9000FA
	01 - 26mm	Electrical signal	Differential	2,7	15/50	0.25	
	02 - 18mm	Electrical signal	Electrical signal	1,7	10	0.165	HB2WXXBG2G9000FA HA2WXXBG2G9000FA
	01 - 26mm	Electrical signal	Electrical signal	1,7	10	0.265	
5/3 Valves							
	02 - 18mm	Electrical signal	Electrical signal	2,4	15/60	0.165	HB5WXXBG2G9000FA HA5WXXBG2G9000FA
	01 - 26mm	Closed center	Self centering	2,4	15/50	0.265	
	02 - 18mm	Electrical signal	Electrical signal	2,4	15/60	0.165	HB6WXXBG2G9000FA HA6WXXBG2G9000FA
	01 - 26mm	Vented center	Self centering	2,4	15/50	0.265	
	02 - 18mm	Electrical signal	Electrical signal	2,4	15/60	0.165	HB7WXXBG2G9000FA HA7WXXBG2G9000FA
	01 - 26mm	Press. center	Self centering	2,4	15/50	0.265	

Pneumatic operated ISO valve

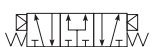
Symbol	Size	Actuation	Return	Signal pressure min. (bar) at 6 bar actua./return	Changeover time (ms) at 6 bar actua./return	Weight Kg	Order code
5/2 Valves							
	02 - 18mm	Air signal	Spring & Diff.	3,1	15/30	0.115	HBFWX000XXA HAFWX000XXA
	01 - 26mm	Air signal	Spring & Diff.	3,1	15/40	0.215	
	02 - 18mm	Air signal	Differential	2,7	10/30	0.115	HB3WX000XXA HA3WX000XXA
	01 - 26mm	Air signal	Differential	2,7	15/35	0.215	
	02 - 18mm	Air signal	Air signal	1,7	8	0.115	HB4WX000XXA HA4WX000XXA
	01 - 26mm	Air signal	Air signal	1,7	10	0.215	
5/3 Valves							
	02 - 18mm	Air signal	Air signal	2,4	15/35	0.115	HB8WX000XXA HA8WX000XXA
	01 - 26mm	Closed center	Self centering	2,4	15/40	0.215	
	02 - 18mm	Air signal	Air signal	2,4	15/35	0.115	HB9WX000XXA HA9WX000XXA
	01 - 26mm	Vented center	Self centering	2,4	15/40	0.215	
	02 - 18mm	Air signal	Air signal	2,4	15/35	0.115	HB0WX000XXA HA0WX000XXA
	01 - 26mm	Press. center	Self centering	2,4	15/40	0.215	

 Indicates stocked product.

ISYS ISO Plug in







Order chart

H
B
1
VX
B
G
0
G9
A

Size	
B	ISO 15407 - 18mm
A	ISO 15407 - 26mm

Pilot source / Pilot exhaust	
B	Internal pilot, port#1 / vented
L	External pilot#14 port / vented

Voltage	
G9	24 VDC
23	115 VAC

Valve type function		
1		Single solenoid, 2 position - Differential
2		Double solenoid, 2 position
5		Double solenoid, 3 position - APB
6		Double solenoid, 3 position - CE
7		Double solenoid, 3 position - PC
E		Single solenoid, 2 position, Air return, spring assist

Overrides	
G	Non-locking, flush, push - w/ light
H	Locking, flush, push / turn - w/ light



* Only available with pilot source / pilot exhaust 'O'.
 Available on HA only, must use DX01 manifold or HA subbase

Shaded part numbers are standard

ISYS ISO

Solenoid operated ISO plug-in valve, 24VDC

Manual override non locking, Led & surge suppressor

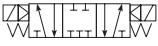
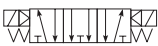
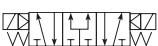
Symbol	Size	Actuation	Return	Signal pressure min. (bar) at 6 bar actua./return	Changeover time (ms) at 6 bar actua./return	Weight Kg	Order code
5/2 Valves							
	02 - 18mm	Electrical signal	Spring & Diff.	3,1	20/40	0.13	HBEVXBG0G9A
	01 - 26mm	Electrical signal	Spring & Diff.	3,1	20/45	0.23	HAEVXBG0G9A
	02 - 18mm	Electrical signal	Differential	2,7	15/40	0.13	HB1VXBG0G9A
	01 - 26mm	Electrical signal	Differential	2,7	15/50	0.23	HA1VXBG0G9A
	02 - 18mm	Electrical signal	Electrical signal	1,7	10	0.145	HB2VXBG0G9A
	01 - 26mm	Electrical signal	Electrical signal	1,7	10	0.245	HA2VXBG0G9A
5/3 Valves							
	02 - 18mm	Electrical signal	Electrical signal	2,4	15/60	0.145	HB5VXBG0G9A
	01 - 26mm	Closed center	Self centering	2,4	15/50	0.245	HA5VXBG0G9A
	02 - 18mm	Electrical signal	Electrical signal	2,4	15/60	0.145	HB6VXBG0G9A
	01 - 26mm	Vented center	Self centering	2,4	15/50	0.245	HA6VXBG0G9A
	02 - 18mm	Electrical signal	Electrical signal	2,4	15/60	0.145	HB7VXBG0G9A
	01 - 26mm	Press. center	Self centering	2,4	15/50	0.245	HA7VXBG0G9A

ISYS ISO - ISO 5599-1 - CNOMO - Size 1 / 2 / 3

Order chart







H
1
E
WX
B
B
L
49
C

Size	
1	ISO 5599-1 - Size 1
2	ISO 5599-1 - Size 2
3	ISO 5599-1 - Size 3

Pilot source / Pilot exhaust	
B	Internal pilot#1 port / vented
X*	External pilot#12 or #14 port / vented

* Must be specified when using Sandwich regulators

Voltage	
42	24 VAC
49	24 VDC
53	120 VAC
57	230 VAC
XX	Valve less coil

Valve type function		
1		Single solenoid, 2 position - Differential
2		Double solenoid, 2 position
5		Double solenoid, 3 position - APB
6		Double solenoid, 3 position - CE
7		Double solenoid, 3 position - PC
E		Single solenoid, 2 position, Differential, spring assist

Enclosure / Lead lengths	
L	3-pin 30mm DIN 43650A with CNOMO operator
N	Valve less coil



Overrides / Lights	
B	Non-locking, flush, push - w/o light
C	Locking, flush, push / turn - w/o light

Shaded part numbers are standard



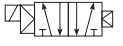

Solenoid operated ISO valve fitted with CNOMO solenoid(s) 24 VDC

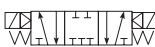
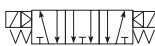
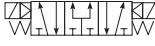
solenoid plug/connector to be ordered separately. See page 58

Symbol	Size	Actuation	Return	Signal pressure min. (bar) at 6 bar actua./return	Changeover time (ms) at 6 bar actua./return	Weight Kg	Order code
5/2 Valves							
	1 - 43mm	Electrical signal	Spring & Diff.	3,1/2,5	25/35	0.77	H1EWXBBL49C
	2 - 56mm	Electrical signal	Spring & Diff.	3,1/2,1	40/70	1.19	H2EWXBBL49C
	3 - 71mm	Electrical signal	Spring & Diff.	3,8/3,3	70/80	1.47	H3EWXBBL49C
	1 - 43mm	Electrical signal	Differential	1,7/1,9	25/45	0.77	H11WXBBL49C
	2 - 56mm	Electrical signal	Differential	2,4/1,7	35/80	1.19	H21WXBBL49C
	3 - 71mm	Electrical signal	Differential	3,5/2,4	55/85	1.47	H31WXBBL49C
	1 - 43mm	Electrical signal	Electrical signal	1,7	15	0.94	H12WXBBL49C
	2 - 56mm	Electrical signal	Electrical signal	1,7	20	1.36	H22WXBBL49C
	3 - 71mm	Electrical signal	Electrical signal	2,4	25	1.64	H32WXBBL49C
5/3 Valves							
	1 - 43mm	Electrical signal	Electrical signal	2,4	15/60	0.94	H15WXBBL49C
	2 - 56mm	Closed center	Self centering	3,5	30/75	1.36	H25WXBBL49C
	3 - 71mm			3,5	23/80	1.64	H35WXBBL49C
	1 - 43mm	Electrical signal	Electrical signal	2,4	15/60	0.94	H16WXBBL49C
	2 - 56mm	Vented center	Self centering	3,5	30/75	1.36	H26WXBBL49C
	3 - 71mm			3,5	23/80	1.64	H36WXBBL49C
	1 - 43mm	Electrical signal	Electrical signal	2,4	15/60	0.94	H17WXBBL49C
	2 - 56mm	Press. center	Self centering	3,5	30/75	1.36	H27WXBBL49C
	3 - 71mm			3,5	23/80	1.64	H37WXBBL49C

Solenoid operated ISO valve fitted with CNOMO operator without coil

Coils and plug/connector should be ordered separately. See page 57

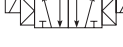
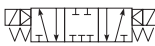
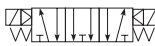
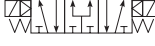
Symbol	Size	Actuation	Return	Signal pressure min. (bar) at 6 bar actua./return	Changeover time (ms) at 6 bar actua./return	Weight Kg	Order code
5/2 Valves							
	1 - 43mm	Electrical signal	Spring & Diff.	3,1/2,5	25/35	0.65	H1EWXBBNXXC
	2 - 56mm	Electrical signal	Spring & Diff.	3,1/2,1	40/70	1.07	H2EWXBBNXXC
	3 - 71mm	Electrical signal	Spring & Diff.	3,8/3,3	70/80	1.35	H3EWXBBNXXC
	1 - 43mm	Electrical signal	Differential	1,7/1,9	25/45	0.65	H11WXBBNXXC
	2 - 56mm	Electrical signal	Differential	2,4/1,7	35/80	1.07	H21WXBBNXXC
	3 - 71mm	Electrical signal	Differential	3,5/2,4	55/85	1.35	H31WXBBNXXC
	1 - 43mm	Electrical signal	Electrical signal	1,7	15	0.7	H12WXBBNXXC
	2 - 56mm	Electrical signal	Electrical signal	1,7	20	1.12	H22WXBBNXXC
	3 - 71mm	Electrical signal	Electrical signal	2,4	25	1.4	H32WXBBNXXC
5/3 Valves							
	1 - 43mm	Electrical signal	Electrical signal	2,4	15/60	0.7	H15WXBBNXXC
	2 - 56mm	Closed center	Self centering	3,5	30/75	1.12	H25WXBBNXXC
	3 - 71mm			3,5	23/80	1.4	H35WXBBNXXC
	1 - 43mm	Electrical signal	Electrical signal	2,4	15/60	0.7	H16WXBBNXXC
	2 - 56mm	Vented center	Self centering	3,5	30/75	1.12	H26WXBBNXXC
	3 - 71mm			3,5	23/80	1.4	H36WXBBNXXC
	1 - 43mm	Electrical signal	Electrical signal	2,4	15/60	0.7	H17WXBBNXXC
	2 - 56mm	Press. center	Self centering	3,5	30/75	1.12	H27WXBBNXXC
	3 - 71mm			3,5	23/80	1.4	H37WXBBNXXC

ISYS ISO 5599-1 Size 1 / 2 / 3 Central Connection

Order chart

H	1	E	WX	B	G	2 B9	000	F	C
----------	----------	----------	-----------	----------	----------	-------------	------------	----------	----------

	Size
1	ISO 5599-1 - Size 1
2	ISO 5599-1 - Size 2
3	ISO 5599-1 - Size 3







	Pilot source / Pilot exhaust
B	Internal pilot#1 port / vented
X*	External pilot#12 port / vented

* Must be specified when using Sandwich regulators

	Wiring options
F	Standard

	Enclosure / Voltage
2B9	4-pin M12 Connector 24 V DC
619	2-pin M12 on coil 24 V DC

	Overrides / Lights
G	Non-locking, flush, push - w/ light
H	Locking, flush, push / turn - w/ light

Valve type function		
1		Single solenoid, 2 position - Differential
2		Double solenoid, 2 position
5		Double solenoid, 3 position - APB
6		Double solenoid, 3 position - CE
7		Double solenoid, 3 position - PC
E		Single solenoid, 2 position, Differential, spring assist

Shaded part numbers are standard









ISYS ISO

ISYS ISO 5599-1 Size 1 / 2 / 3 Remote Pilot

Order chart

H	1	F	WX 000 XX C
----------	----------	----------	--------------------

	Size
1	ISO 5599-1 - Size 1
2	ISO 5599-1 - Size 2
3	ISO 5599-1 - Size 3

	Valve type function
3	 Single remote pilot, 2 position - Differential
4	 Double remote pilot, 2 position
8	 Double remote pilot, 3 position - APB
9	 Double remote pilot, 3 position - CE
0	 Double remote pilot, 3 position - PC
F	 Single solenoid, 2 position, Differential, spring assist



Shaded part numbers are standard





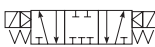
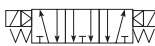
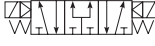

ISYS ISO

Solenoid operated ISO valve, 24VDC, central M12 connection

Oriented side 14, Led & surge suppressor

Symbol	Size	Actuation	Return	Signal pressure min. (bar) at 6 bar actua./return	Changeover time (ms) at 6 bar actua./return	Weight Kg	Order code
5/2 Valves							
	1 - 43mm	Electrical signal	Spring & Diff.	3,1/2,5	30/40	0.77	H1EWXBG2B9000FC H2EWXBG2B9000FC H3EWXBG2B9000FC
	2 - 56mm	Electrical signal	Spring & Diff.	3,1/2,1	45/70	1.29	
	3 - 71mm	Electrical signal	Spring & Diff.	3,8/3,3	75/80	1.57	
	1 - 43mm	Electrical signal	Differential	1,7/1,9	30/50	0.77	H11WXBG2B9000FC H21WXBG2B9000FC H31WXBG2B9000FC
	2 - 56mm	Electrical signal	Differential	2,4/1,7	40/80	1.29	
	3 - 71mm	Electrical signal	Differential	3,5/2,4	60/85	1.57	
	1 - 43mm	Electrical signal	Electrical signal	1,7	20	1.04	H12WXBG2B9000FC H22WXBG2B9000FC H32WXBG2B9000FC
	2 - 56mm	Electrical signal	Electrical signal	1,7	25	1.46	
	3 - 71mm	Electrical signal	Electrical signal	2,4	30	1.74	
5/3 Valves							
	1 - 43mm	Electrical signal	Electrical signal	2,4	20/65	1.04	H15WXBG2B9000FC H25WXBG2B9000FC H35WXBG2B9000FC
	2 - 56mm	Closed center	Self centering	3,5	35/80	1.46	
	3 - 71mm			3,5	40/85	1.74	
	1 - 43mm	Electrical signal	Electrical signal	2,4	20/65	1.04	H16WXBG2B9000FC H26WXBG2B9000FC H36WXBG2B9000FC
	2 - 56mm	Vented center	Self centering	3,5	35/80	1.46	
	3 - 71mm			3,5	40/85	1.74	
	1 - 43mm	Electrical signal	Electrical signal	2,4	20/65	1.04	H17WXBG2B9000FC H27WXBG2B9000FC H37WXBG2B9000FC
	2 - 56mm	Press. center	Self centering	3,5	35/80	1.46	
	3 - 71mm			3,5	40/85	1.74	

Pneumatic operated ISO valve without manual override

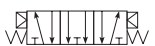
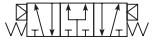
Symbol	Size	Actuation	Return	Signal pressure min. (bar) at 6 bar actua./return	Changeover time (ms) at 6 bar actua./return	Weight Kg	Order code
5/2 Valves							
	1 - 43mm	Electrical signal	Spring & Diff.	3,1/2,5	20/30	0.6	H1FWX000XXC H2FWX000XXC H3FWX000XXC
	2 - 56mm	Electrical signal	Spring & Diff.	3,1/2,1	35/70	1.02	
	3 - 71mm	Electrical signal	Spring & Diff.	3,8/3,3	65/75	1.3	
	1 - 43mm	Electrical signal	Differential	1,7/1,9	20/40	0.6	H13WX000XXC H23WX000XXC H33WX000XXC
	2 - 56mm	Electrical signal	Differential	2,4/1,7	30/80	1.02	
	3 - 71mm	Electrical signal	Differential	3,5/2,4	50/85	1.3	
	1 - 43mm	Electrical signal	Electrical signal	1,7	12	0.6	H14WX000XXC H24WX000XXC H34WX000XXC
	2 - 56mm	Electrical signal	Electrical signal	1,7	16	1.02	
	3 - 71mm	Electrical signal	Electrical signal	2,4	20	1.3	
5/3 Valves							
	1 - 43mm	Electrical signal	Electrical signal	2,4	15/55	0.6	H18WX000XXC H28WX000XXC H38WX000XXC
	2 - 56mm	Closed center	Self centering	3,5	20/70	1.12	
	3 - 71mm			3,5	30/80	1.3	
	1 - 43mm	Electrical signal	Electrical signal	2,4	15/55	0.6	H19WX000XXC H29WX000XXC H39WX000XXC
	2 - 56mm	Vented center	Self centering	3,5	20/70	1.02	
	3 - 71mm			3,5	30/80	1.3	
	1 - 43mm	Electrical signal	Electrical signal	2,4	15/55	0.6	H10WX000XXC H20WX000XXC H30WX000XXC
	2 - 56mm	Press. center	Self centering	3,5	20/70	1.02	
	3 - 71mm			3,5	30/80	1.3	

ISYS ISO - 5599-2 - Size 1 / 2 / 3 - Plug in
Order chart

H
1
E
VX
B
G
0
B9
C

Size	
1	ISO 5599-2 - Size 1
2	ISO 5599-2 - Size 2
3	ISO 5599-2 - Size 3

Pilot source / Pilot exhaust	
B	Internal pilot#1 port / vented
X*	External pilot#12 or #14 port / vented

* Must be specified when using Sandwich regulators

Voltage & Frequency				
	AC		DC	Light & surge sup
	60Hz	50Hz		
42				
45			12	
B9*			24	LED & Sup
23	120	115		LED & Sup
57	240			
XX	Valve less coil			

* Solenoid is blue

Valve type function		
1		Single solenoid, 2 position - Differential
2		Double solenoid, 2 position
5		Double solenoid, 3 position - APB
6		Double solenoid, 3 position - CE
7		Double solenoid, 3 position - PC
E		Single solenoid, 2 position, Differential, spring assist

* Only available with pilot source / pilot exhaust 'O'.

Enclosure	
0	Non, Valve with coil
N	Non, Valve less coil

Overrides / Lights	
B	Non-locking, flush, push - w/o light
C	Locking, flush, push / turn - w/o light
G	Non-locking, flush, push - with light
H	Locking, flush, push / turn - with light





Shaded part numbers are standard

ISYS ISO

Subbase & Manifolds - See page **

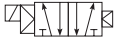



Solenoid operated ISO valve, 24VDC, Plug-in

Led & surge suppressor

Symbol	Size	Actuation	Return	Signal pressure min. (bar) at 6 bar actua./return	Changeover time (ms) at 6 bar actua./return	Weight Kg	Order code
5/2 Valves							
	1 - 43mm	Electrical signal	Spring & Diff.	3,1/2,5	30/40	0.77	H1EVXBG0B9C
	2 - 56mm	Electrical signal	Spring & Diff.	3,1/2,1	45/70	1.19	H2EVXBG0B9C
	3 - 71mm	Electrical signal	Spring & Diff.	3,8/3,3	75/80	1.47	H3EVXBG0B9C
	1 - 43mm	Electrical signal	Differential	1,7/1,9	30/50	0.77	H11VXBG0B9C
	2 - 56mm	Electrical signal	Differential	2,4/1,7	40/80	1.19	H21VXBG0B9C
	3 - 71mm	Electrical signal	Differential	3,5/2,4	60/85	1.47	H31VXBG0B9C
	1 - 43mm	Electrical signal	Electrical signal	1,7	20	0.94	H12VXBG0B9C
	2 - 56mm	Electrical signal	Electrical signal	1,7	25	1.36	H22VXBG0B9C
	3 - 71mm	Electrical signal	Electrical signal	2,4	30	1.64	H32VXBG0B9C
5/3 Valves							
	1 - 43mm	Electrical signal	Electrical signal	2,4	20/65	0.94	H15VXBG0B9C
	2 - 56mm	Closed center	Self centering	3,5	35/80	1.36	H25VXBG0B9C
	3 - 71mm			3,5	40/85	1.64	H35VXBG0B9C
	1 - 43mm	Electrical signal	Electrical signal	2,4	20/65	0.94	H16VXBG0B9C
	2 - 56mm	Vented center	Self centering	3,5	35/80	1.36	H26VXBG0B9C
	3 - 71mm			3,5	40/85	1.64	H36VXBG0B9C
	1 - 43mm	Electrical signal	Electrical signal	2,4	20/65	0.94	H17VXBG0B9C
	2 - 56mm	Press. center	Self centering	3,5	35/80	1.36	H27VXBG0B9C
	3 - 71mm			3,5	40/85	1.64	H37VXBG0B9C

Solenoid operated ISO valve, with plug in operator, without coil

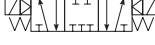
coil have to be ordered separately, see page 40

Symbol	Size	Actuation	Return	Signal pressure min. (bar) at 6 bar actua./return	Changeover time (ms) at 6 bar actua./return	Weight Kg	Order code
5/2 Valves							
	1 - 43mm	Electrical signal	Spring & Diff.	3,1/2,5	30/40	0.65	H1EVXBGNXXC
	2 - 56mm	Electrical signal	Spring & Diff.	3,1/2,1	45/70	1.07	H2EVXBGNXXC
	3 - 71mm	Electrical signal	Spring & Diff.	3,8/3,3	75/80	1.35	H3EVXBGNXXC
	1 - 43mm	Electrical signal	Differential	1,7/1,9	30/50	0.65	H11VXBGNXXC
	2 - 56mm	Electrical signal	Differential	2,4/1,7	40/80	1.07	H21VXBGNXXC
	3 - 71mm	Electrical signal	Differential	3,5/2,4	60/85	1.35	H31VXBGNXXC
	1 - 43mm	Electrical signal	Electrical signal	1,7	20	0.7	H12VXBGNXXC
	2 - 56mm	Electrical signal	Electrical signal	1,7	25	1.12	H22VXBGNXXC
	3 - 71mm	Electrical signal	Electrical signal	2,4	30	1.4	H32VXBGNXXC
5/3 Valves							
	1 - 43mm	Electrical signal	Electrical signal	2,4	20/65	0.7	H15VXBGNXXC
	2 - 56mm	Closed center	Self centering	3,5	35/80	1.12	H25VXBGNXXC
	3 - 71mm			3,5	40/85	1.4	H35VXBGNXXC
	1 - 43mm	Electrical signal	Electrical signal	2,4	20/65	0.7	H16VXBGNXXC
	2 - 56mm	Vented center	Self centering	3,5	35/80	1.12	H26VXBGNXXC
	3 - 71mm			3,5	40/85	1.4	H36VXBGNXXC
	1 - 43mm	Electrical signal	Electrical signal	2,4	20/65	0.7	H17VXBGNXXC
	2 - 56mm	Press. center	Self centering	3,5	35/80	1.12	H27VXBGNXXC
	3 - 71mm			3,5	40/85	1.4	H37VXBGNXXC

Side ported subbase

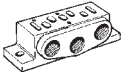
	Description	Port size	Weight	Order code BSPP "G"	Order code NPT
	Individual subbase kit				
	Subbase with side port				
	Size 02	G1/8	0.07	PL02-01-70	PL02-01-80
	Size 01	G1/4	0.12	PL01-02-70	PL01-02-80



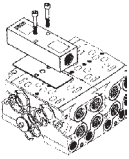

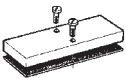

Side ported manifold

	Description	Port size	Weight	Order code BSPP "G"	Order code NPT
	Two station manifold base with side ports				
	To suit valves with internal supply solenoid				
	Size 02	G1/8	0.14	PJLP02-201-70	PJLP02-201-80
	Size 01	G1/4	0.7	PJLP01-202-70	PJLP01-202-80
	Two station manifold base				
	To suit pneumatic actuated valves				
	Size 01	G1/4	0.73	PJL01-202-70	PJL01-202-80
	End plate kit - for side ported two station manifold base				
	Size 02	G1/4	0.15	PEJ02-02-70	PEJ02-02-80*
	Size 01	G3/8	0.52	PEJ01-03-70	PEJ01-03-80**
	* Use with PJLP02				
	** Use with PJLP01 or PJL01				
	Gaskets and assembly hardware included.				

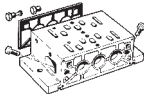
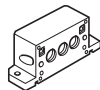
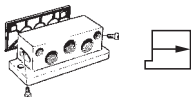
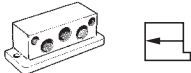
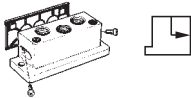
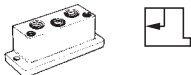
Accessories

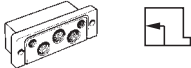
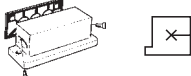
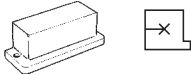
	Description	Weight	Order code
	Blanking plate		
	Size 02	0.04	DX02BLK
	Size 01	0.05	DX01BLK
	Blanking plug (for subbase PJL)		
	Size 02	0.01	D02BD0
	Size 01	0.02	D01BD0
	Bolt, washer and nut		
	Size 02		DX02M2MB
	Size 01		DX01M2MB

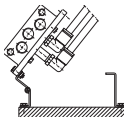
Bottom ported manifolds

Accessories	Designation	Weight (kg)	Order code (P2V-A, 18 mm)	Weight (kg)	Order code (P2V-B, 26 mm)
	Multiple manifold Including seal, fitting screws and plugs. Ports 2, 4, and 14 are bottom-connected. Fit plugs as required to provide common supply of operating air and common exhausts for solenoid valves. Plug assembly instruction, see page 35.	0,20	P2V-AM511NB	0,40	P2V-BM512NB
	Multiple manifold Multiple manifold as above, but with the plugs fitted to suit use with valves with internal supply to solenoid.	0,20	P2V-AM511PB	0,40	P2V-BM512PB
	Intermediate manifold, 18 to 26 mm Including seals and fitting screws. For connecting P2V-AM511NB/PB multiple manifolds to P2V-BM511NB/PB multiple manifolds.	0,33	P2V-AM500BE	0,33	P2V-AM500BE
	Connection block G-side, including seal and fitting screws. For side connection.	0,18	P2V-AM512GS	0,21	P2V-BM513GS
	Connection block H-side. For side connection.	0,18	P2V-AM512HS	0,21	P2V-BM513HS
	Connection block G-side, including seal and fitting screws. For top connection.	0,18	P2V-AM512GT	0,21	P2V-BM513GT
	Connection block H-side. For top connection.	0,18	P2V-AM512HT	0,21	P2V-BM513HT
	Connection block G-side, including seal and fitting screws. For bottom connection.	0,18	P2V-AM512GB	0,22	P2V-BM513GB
	Connection block H-side. For bottom connection.	0,18	P2V-AM512HB	0,22	P2V-BM513HB
	End cover G-side, including seal and fitting screws.	0,19	P2V-AM500G0	0,24	P2V-BM500G0
	End cover H-side	0,19	P2V-AM500H0	0,24	P2V-BM500H0
	Plug For sealing supply and exhaust air ducts between multiple manifolds with different primary supply pressures.	0,004	P2V-AK0P	0,01	P2V-BK0P
	Angle mounting set For raising multiple manifolds so that angle connections can be fitted to the underside. The parts are designed so that the entire manifold can be angled to simplify connection of the pipes. The set consists of four mounts, complete with all necessary screws and nuts.	0,14	P2V-AK0M	0,14	P2V-AK0M
	O-ring strip seal For sealing between bases and multiple manifolds. 3.53 mm diameter, Supplied in 5 m lengths.	0,07	9304331543	0,07	9304331543

Side ported manifold

Description	Port size	Order code
	Manifold with two valve positions with terminal Strip (Non collective wiring) Size 01 - 26mm	G1/4 PS551154CP
	Manifold with two single solenoid valve positions with single address board Size 02 - 18mm Size 01 - 26mm	G1/8 PS561152JP
		G1/4 PS551154JP
	Manifold with two valve positions with double address board Size 02 - 18mm Size 01 - 26mm	G1/8 PS561152MP
		G1/4 PS551154MP
	Extension Manifold with two valve positions with single address board * Size 02 - 18mm Size 01 - 26mm	G1/8 PS561152NP
G1/4 PS551154NP		
Extension Manifold with two valve positions with double address board * Size 02 Size 01	G1/8 PS561152PP	
	G1/4 PS551154PP	

* Use only one per manifold assembly to address more 24 solenoid

Side & bottom ported manifold







Description	Port size	Order code
	Manifold with two valve positions with terminal Strip Size 01 - 26mm	G1/4 PS551164CP
	Manifold with two valve positions with single address board Size 02 - 18mm Size 01 - 26mm	G1/8 PS561162JP
		G1/4 PS551164JP
	Manifold with two valve positions with double address board Size 02 - 18mm Size 01 - 26mm	G1/8 PS561162MP
		G1/4 PS551164MP
	Extension Manifold with two valve positions with single address board Size 02 - 18mm Size 01 - 26mm	G1/8 PS561162NP
G1/4 PS551164NP		
Extension Manifold with two valve positions with double address board Size 02 Size 01	G1/8 PS561162PP	
	G1/4 PS551164PP	

Accessories



Description	Order code
	Blanking plate Size 02 - 18mm Size 01 - 26mm
	PS5634P PS5534P
Manifold to Manifold gasket kit	HA & HB Gasket Standard
	HA & HB Gasket 1 Blocked
	HA & HB Gasket 1 2 3 Blocked
	PS561AP PS561BP PS561CP

 Indicates stocked product.

Collective wiring end plate kits

Description	Port size	Order code
	Left & right ends modules with pressure & exhaust port, auxiliary port , and non collective wiring (only for PS551154CP) Size 02 / 01	G3/8 PS5631011P
	Left & right ends modules with pressure & exhaust port, auxiliary port , and SubD25 connection Size 02 / 01	G3/8 PS5620L21P
	Left & right ends modules with pressure & exhaust port, auxiliary port , and 19pin Brad Harrison connection Size 02 / 01	G3/8 PS5620L31P
	Left & right ends modules with pressure & exhaust port, auxiliary port , and 12pin M23 connection Size 02 / 01	G3/8 PS5620L41P
	Left & right ends modules with pressure & exhaust port, auxiliary port , and 16 point terminal strip Size 02 / 01	G3/8 PS5620L51P
	Left & right ends modules with pressure & exhaust port, auxiliary port , and ISYSNET (32 output driver is included) Size 02 / 01	G3/8 PS5620L61P

Accessories

Description	Port size	Order code
	32 output driver module for spare part	PSSV32A
	HA & HB 24 Out Cable Size 02 / 01	G3/8 PS5624P
	HA & HB 32 Out cable Size 02 / 01	G3/8 PS5632P
25 pin female 25 pin SubD25 cable 3m		P8LMH25M3A

ISO 5599-1 Subbase & Manifolds

VDMA Side Ported Subbases

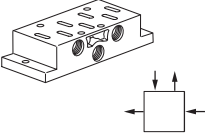
Description	Size	Port size	Weight	Order code
 <p>Subbases VDMA Side port according to VDMA Side port according to VDMA Side port according to VDMA</p>	1 - 43mm	G1/4	0.16	P2N-VS512SD
	2 - 56mm	G3/8	0.28	P2N-WS513SD
	3 - 71mm	G1/2	0.35	P2N-YS514SD

VDMA Bottom Ported Manifold

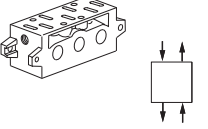
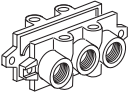
Description	Size	Port size	Weight	Order code
 <p>VDMA Form C Bottom port according to VDMA Bottom port according to VDMA Bottom port according to VDMA</p>	1 - 43mm	G1/4	0.24	P2N-VM512MB
	2 - 56mm	G3/8	0.36	P2N-WM513MB
	3 - 71mm	G1/2	0.70	P2N-YM514MB
<p>VDMA Transition plate Size 1 to Size 3 Kit includes: Transition plate only</p>	1 to 3	G1/4		P2N-VM500AK
 <p>VDMA Form D - End plate According to VDMA According to VDMA According to VDMA</p>	1 - 43mm	G3/8	0.21	P2N-VM513ES
	2 - 56mm	G1/2	0.36	P2N-WM514ES
	3 - 71mm	G1	0.68	P2N-YM518ES
<p>VDMA Isolation - Main galley According to VDMA According to VDMA According to VDMA Kit includes: (1) Isolator plug.</p>	1 - 43mm			P2N-VK0P
	2 - 56mm			P2N-WK0P
	3 - 71mm			P2N-YK0P

Accessories

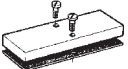
Description	Size	Port size	Weight	Order code
 <p>Blanking plate Kit includes: (1) Blanking plate, (1) Gasket and (4) Mounting bolts</p>	1 - 43mm	G1/4	0.10	P2N-AA5B
	2 - 56mm	G3/8	0.15	P2N-BA5B
	3 - 71mm	G1/2	0.20	P2N-CA5B







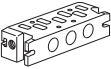

Side ported subbases

Description	Size	Port size	Weight	Order code BSP	Order code NPT
 Single subbase with side ports 1 3 5 2 4 ports & 12 14	1 - 43mm	G1/4	0.16	PL1-1/4-70	PL1-1/4-80
	1 - 43mm	G3/8	0.16	PL1-3/8-70	
	2 - 56mm	G3/8	0.28	PL2-3/8-70	PL2-3/8-80
	2 - 56mm	G1/2		P2N-HS514SS	
	3 - 71mm	G1/2		PL3-1/2-70	PL3-1/2-80
	3 - 71mm	G3/4		P2N-JS516SD	

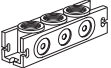

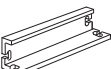

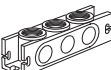
Bottom ported subbases

Description	Size	Port size	Weight	Order code BSP	Order code NPT
 Single subbase with side ports 1 3 5 2 4 ports & 12 14	1 - 43mm	G1/4	0.37	PD1-1/4-70	PD1-1/4-80
	2 - 56mm	G3/8	0.59	PD2-3/8-70	PD2-3/8-80
	3 - 71mm	G1/2	0.59	PD3-1/2-70	

Size 1 bottom ported manifold

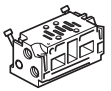
Description	Size	Port size	Weight	Order code
  Manifold with bottom ports low profile	1 - 43mm	G1/4	0.2	P2N-AM512MB
  Connecting block Top or bottom ported connecting block for above manifold "low profile"	1 - 43mm	G3/8	0.15	P2N-AM513GT
  End End piece for above manifold "low profile"	1 - 43mm	no	0.06	P2N-AM500J
  Intermediate supply Top or bottom ported intermediate supply for above manifold "low profile"	1 - 43mm	G3/8	0.14	P2N-AM513BT
 Isolation plugs isolating seal for above manifold "low profile"	1 - 43mm		0.07	P2N-AK0P

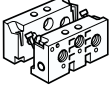
Sizes 1 & 2 side ported manifold

Description	Size	Port size	Weight	Order code
  Manifold Manifold with side port	1 - 43mm	G1/4	0.24	P2N-EM512MD
	2 - 56mm	G3/8	0.21	P2N-FM513MD
  End Side ported connecting kit for above manifold with side ports	1 - 43mm	G3/8	0.36	P2N-EM513ES
	2 - 56mm	G1/2	0.29	P2N-FM514ES

Side ported manifold

Description	Size	Port size	Order code
 Manifold with terminal Strip (non collective wiring)	1 - 43mm	G3/8	PS401156CCP
	2 - 56mm	G1/2	PS411158CCP
	3 - 71mm	G3/4	PS421150CCP
Manifold with single address board (single solenoid)	1 - 43mm	G3/8	PS401156JCP
Manifold with double address board	1 - 43mm	G3/8	PS401156MCP





Accessories

Description	Order code
 Blanking plate	1 - 43mm G3/8 PS4034CP
	2 - 56mm G1/2 PS4134CP
	3 - 71mm G3/4 PS4234CP
Insulation plug	1 - 43mm G3/8 PS4032CP
	2 - 56mm G1/2 PS4132CP
	3 - 71mm G3/4 PS4232CP
Manifold to Manifold gasket kit	1 - 43mm G3/8 PS4013P

Coils for plug in valve

Description	Order code
	12 V DC 5599-2 coil PS404145P
	24 V DC 5599-2 coil PS4041B9P
	24 V AC 5599-2 coil PS404142P
	120 V AC 5599-2 coil PS404123P
	240 V AC 5599-2 coil PS404157P

Collective wiring end plate kits

	Description	Port size	Order code
	Left & right ends modules with pressure & exhaust port, auxiliary port , and non collective wiring		
	Size 1	G1/2	PS4031011CP
	Size 2	G3/4	PS4131011CP
	Size 3	G3/4	PS4231011CP
	Left & right ends modules with pressure & exhaust port, auxiliary port , and SubD25 connection		
	Size 1	G1/2	PS4020L21CP
	Left & right ends modules with pressure & exhaust port, auxiliary port , and 19pin Brad Harrison connection		
	Size 1	G1/2	PS4020L31CP
	Left & right ends modules with pressure & exhaust port, auxiliary port , and 12pin M23 connection		
	Size 1	G1/2	PS4020L41CP
	Left & right ends modules with pressure & exhaust port, auxiliary port , and ISYSNET		
	Size 1	G3/8	PS4020L61CP

Accessories

	Description	Order code
	32 output driver module for spare part	PSSV32A
	HA & HB 24 Out Cable	PS4024P
	25 pin female 25 pin SubD25 cable 3m	P8LMH25M3A
	H1 H2 H3 Pilot Gasket	PS4007P
	Valve to base gasket	PS4005CP

Regulators - HA & HB - 15407

Accessories - Sandwich Regulator

Features

- Remote air pilot operated for hard-to-reach pressure control.
- Unregulated pilot pressure to valve for consistent valve shifting regardless of pressure adjustment.

Gauge adaptor kit

Included with all HB Regulators. Both kits are required on all HA & HB Regulators when the Regulator is on the last station on the right (14) end.



Description	Order code
Gauge kit	PS5651160P

HB & HA Common Port Regulation

Provides adjustable regulated air pressure to the valves #1 port which gives the same pressure to both the #2 and #4 port of the manifold or subbase. The regulator is always on the 14 end of the valve.

Common port regulator with 4-way, 2-position single solenoid valve

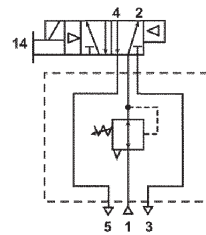

Common port regulator with 4-way, 3-position APB valve

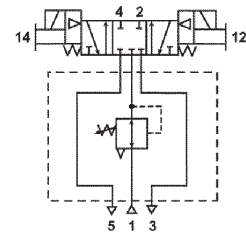

HA - 26mm (Common Port Regulator shown)



8 bar

Order code

	Plug-in	Non Plug-in
Size 18mm	PS5638133P	PS5637133P
Size 26mm	PS5538133P	PS5537133P

HB & HA Independent Port Regulation

Dual Port Regulator

Provides regulated pressure to both ports. Pressure regulation can occur out of the #2 or #4 port of the valve. In this case #2 and #4 have to be cross wired.

3 position CP have to be used as a COE
 3 position COE have to be used as a CP

Independent dual port regulator with 4-way, 2-position double solenoid valve

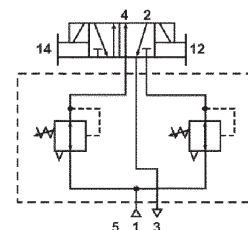

Order chart - Sandwich Regulator (please contact Parker Sales Office)

PS5637	1	6	6	P																																															
<table border="1"> <thead> <tr> <th colspan="3">Series</th> </tr> </thead> <tbody> <tr> <td colspan="3" style="text-align: center;">HB</td> </tr> <tr> <td>15407-1</td> <td>18mm</td> <td>PS5537</td> </tr> <tr> <td>15407-2</td> <td>18mm</td> <td>PS5538</td> </tr> <tr> <td colspan="3" style="text-align: center;">HA</td> </tr> <tr> <td>15407-1</td> <td>26mm</td> <td>PS5537</td> </tr> <tr> <td>15407-2</td> <td>26mm</td> <td>PS5538</td> </tr> </tbody> </table>	Series			HB			15407-1	18mm	PS5537	15407-2	18mm	PS5538	HA			15407-1	26mm	PS5537	15407-2	26mm	PS5538	<table border="1"> <thead> <tr> <th colspan="2">Regulator function</th> </tr> </thead> <tbody> <tr> <td style="text-align: center;">1</td> <td>Common pressure regulator</td> </tr> <tr> <td style="text-align: center;">2</td> <td>Independent pressure regulator</td> </tr> </tbody> </table>	Regulator function		1	Common pressure regulator	2	Independent pressure regulator	<table border="1"> <thead> <tr> <th colspan="2">#4 Port regulator / Gauge*</th> </tr> </thead> <tbody> <tr> <td style="text-align: center;">2</td> <td>2-60 PSIG w/o Gauge</td> </tr> <tr> <td style="text-align: center;">3</td> <td>5-125 PSIG w/o Gauge</td> </tr> <tr> <td style="text-align: center;">5</td> <td>2-60 PSIG w/Gauge</td> </tr> <tr> <td style="text-align: center;">6</td> <td>5-125 PSIG w/Gauge</td> </tr> </tbody> </table> <p>* For common pressure regulator option. Regulator gauge callout must be the same number for both Port #4 and port #2. (Example: 166)</p>	#4 Port regulator / Gauge*		2	2-60 PSIG w/o Gauge	3	5-125 PSIG w/o Gauge	5	2-60 PSIG w/Gauge	6	5-125 PSIG w/Gauge	<table border="1"> <thead> <tr> <th colspan="2">#2 Port regulator / Gauge*</th> </tr> </thead> <tbody> <tr> <td style="text-align: center;">2</td> <td>2-60 PSIG w/o Gauge</td> </tr> <tr> <td style="text-align: center;">3</td> <td>5-125 PSIG w/o Gauge</td> </tr> <tr> <td style="text-align: center;">5</td> <td>2-60 PSIG w/Gauge</td> </tr> <tr> <td style="text-align: center;">6</td> <td>5-125 PSIG w/Gauge</td> </tr> </tbody> </table> <p>* For common pressure regulator option. Regulator gauge callout must be the same number for both Port #4 and port #2. (Example: 166)</p>	#2 Port regulator / Gauge*		2	2-60 PSIG w/o Gauge	3	5-125 PSIG w/o Gauge	5	2-60 PSIG w/Gauge	6	5-125 PSIG w/Gauge	
Series																																																			
HB																																																			
15407-1	18mm	PS5537																																																	
15407-2	18mm	PS5538																																																	
HA																																																			
15407-1	26mm	PS5537																																																	
15407-2	26mm	PS5538																																																	
Regulator function																																																			
1	Common pressure regulator																																																		
2	Independent pressure regulator																																																		
#4 Port regulator / Gauge*																																																			
2	2-60 PSIG w/o Gauge																																																		
3	5-125 PSIG w/o Gauge																																																		
5	2-60 PSIG w/Gauge																																																		
6	5-125 PSIG w/Gauge																																																		
#2 Port regulator / Gauge*																																																			
2	2-60 PSIG w/o Gauge																																																		
3	5-125 PSIG w/o Gauge																																																		
5	2-60 PSIG w/Gauge																																																		
6	5-125 PSIG w/Gauge																																																		

How to Configure Sandwich Regulator / Valve Combinations

Ordering Components

- Manifold or Subbase Kit required.
- Sandwich Regulator Kit configured for Internal Pilot as standard.
- Order valve as External Pilot.

Internal Pilot Configuration -

Pressure in Base Port 1 feeds regulator configured for Internal Pilot which feeds valve configured for External Pilot.

Flow control - ISO 15407 - Sandwich flow controls features

- Both adjustment screws are located on the 12 end of the unit.
- Sandwich Flow Control mounts with its own studs, which means the valve uses standard bolts for mounting.
- Sandwich Flow Control is not to be used as a shut off device and is not bubble tight when needles are fully turned down.



**Plug-In
 15407-2
 18mm Shown**

Size	Order code	
	Plug-in	Non Plug-in
	15407-2	15407-1
Size 18mm	PS5635P	PS5642P
Size 26mm	PS5535P	PS5542P

Regulators - Size 1 / 2 / 3 - ISO 5599

Accessories - Sandwich Regulator

Features

- Remote air pilot operated for hard-to-reach pressure control.
- Unregulated pilot pressure to valve for consistent valve shifting regardless of pressure adjustment.

Gauge adaptor kit

Included with all HB Regulators. Both kits are required on all HA & HB Regulators when the Regulator is on the last station on the right (14) end.



Description	Order code
Gauge kit	PS5651160P

ISYS ISO 1 / 2 / 3 Common Port Regulation

Provides adjustable regulated air pressure to the valves #1 port which gives the same regulated pressure to both the #2 and #4 port of the manifold or subbase. The regulator is always on the 14 end of the valve.

Common port regulator with 4-way, 2-position single solenoid valve

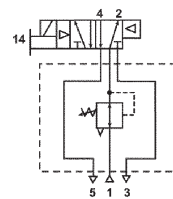

Common port regulator with 4-way, 3-position APB valve

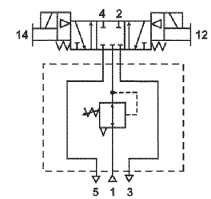

Order code

Size	8 bar	Plug-in	Non Plug-in
		PS4038133CP	PS5037133CP

ISYS ISO 1 / 2 / 3 Independent Port Regulation

Dual Port Regulator or Single Port Regulator

Provides regulated pressure to both ports. Pressure regulation can occur out of the #2 or #4 port of the valve. Full line pressure would be provided with a pass plate.



When using an independent Pressure Sandwich Regulator, the cylinder outlet ports are reversed. The 12 end energizes the #2 port. The 3-Position CE and PC functions are also reversed. (See schematics on right).

Independent dual port regulator with 4-way, 2-position double solenoid valve

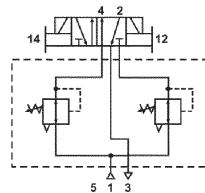

Independent port regulator with 4-way, 3-position all ports blocked valve

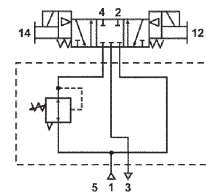

Independent port regulator with 4-way, 3-position inlet to cylinder function

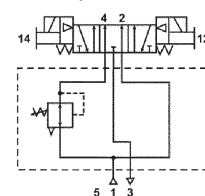

Independent port regulator with 4-way, 3-position cylinder to exhaust function

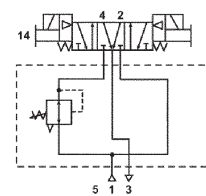

CAUTION: Requires 4-way, 3-position, cylinder to exhaust valve



CAUTION: Requires 4-way, 3-position, cylinder to exhaust valve

ISYS ISO 1 / 2 / 3 Selector Regulation

Supplies two different pressures to the valves #1 and #3 flow paths. Shifting the valve "selects" one or the other of these two pressures to flow out port #2. A Selector Regulator can: 1) Provide regulated pressure to one flow path and full line pressure to the other by use of the Line Pressure By-Pass Plate.

Selector regulator with 4-way, 2-position single solenoid valve

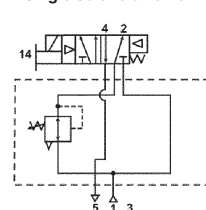

Order chart - Sandwich Regulator (please contact Parker Sales Office)

PS4037	1	6	6	C	P	
Series	Regulator function		#4 Port regulator / Gauge*		#2 Port regulator / Gauge*	
ISYS ISO Size 1	1	Common pressure regulator	0	Line By-Pass Plate**		
5599-1 PS4037	2	Independent pressure regulator	1	1-30 PSIG w/o Gauge		
5599-2 PS4038	3	Selector Regulator	2	2-60 PSIG w/o Gauge		
ISYS ISO Size 2			3	5-125 PSIG w/o Gauge		
5599-1 PS4137			4	1-30 PSIG w/Gauge		
5599-2 PS4138			5	2-60 PSIG w/Gauge		
ISYS ISO Size 3			6	5-125 PSIG w/Gauge		
5599-1 PS4237			C	Air Pilot w/60 PSIG Gauge		
5599-2 PS4238			D	Air Pilot w/60 PSIG Gauge		

* For common pressure regulator option. Regulator gauge callout must be the same number for both Port #4 and port #2. (Example: 166)

** Pressure Line By-Pass Option can only be used with independent and Selector Regulators (Option 2 & 3 in Sandwich Block Function).

How to Configure Sandwich Regulator / Valve Combinations

Ordering Components

- Manifold or Subbase Kit required.
- Sandwich Regulator Kit configured for Internal Pilot as standard.
- Order valve as External Pilot.

Internal Pilot Configuration -

Pressure in Base Port 1 feeds regulator configured for Internal Pilot which feeds valve configured for External Pilot.

External Pilot Configuration - H1, H2, H3

An External Pilot pressure in Port 12 or 14 of the base feeds thru the Sandwich Regulator 12 or 14 galley directly to the 12/14 pilot of the valve.

This configuration takes an External Pilot from the 12 port of the base and passes it thru the regulator to feed the 12 galley of the valve.

Flow Control - Size 1 / 2 / 3 - ISO 5599 - Sandwich flow controls features

- Both adjustment screws are located on the 12 end of the unit.
- Sandwich Flow Control mounts with its own studs, which means the valve uses standard bolts for mounting.

Size	Order code	
	Plug-in 5599-2	Non Plug-in 5599-1
Size 1	PS4035CP	PS4042CP
Size 2	PS4135CP	PS4142CP
Size 3	PS4235CP	PS4242CP

Plug-In
5599-2
Size 2 Shown

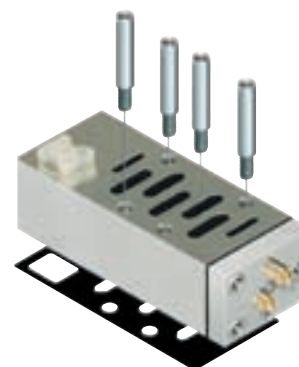

ISYSNET Field Bus System Field Bus System

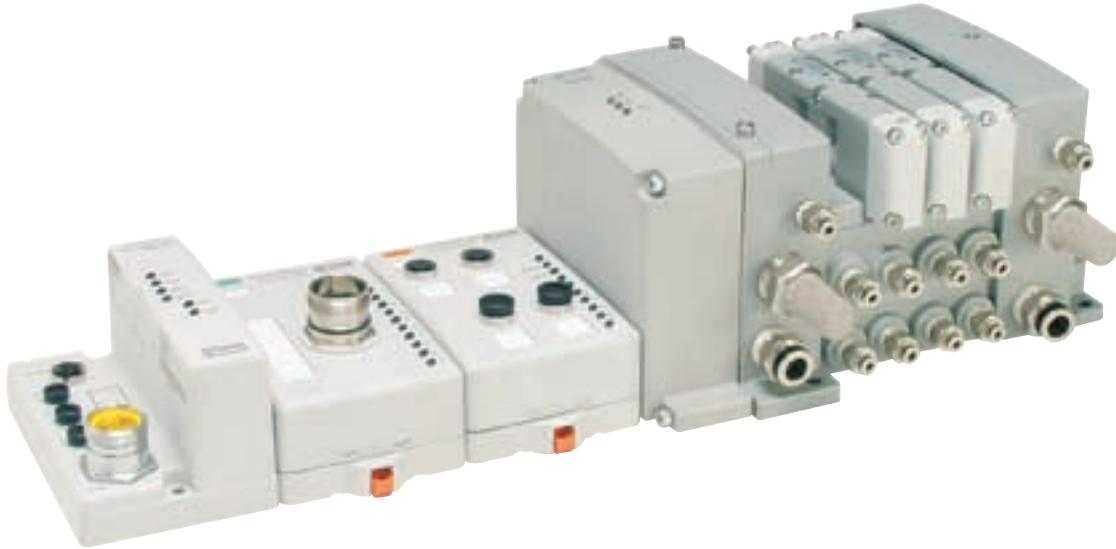

Integrated Solution

- A complete field bus communication offering for all ISO valves.
- Extremely fast I/O backplane uses change-of-state (COS) connections to maximize performance.
- UL, C-UL and CE certifications (as marked).

I/O Modules

- Accepts signals from sensors, photo eyes, limits and other field input devices.
- Provides signals to remotely operating solenoid valves and other field operating output devices.
- Choice of digital, analog, high watt I/O Modules.
- Choose from a broad range of color coded I/O types with connector choices of 8mm, 12mm or M23.
- Built-in miswiring, short circuit, open circuit detection with electronic feedback.

Modularity

- Ease of module replacement with unique latching mechanisms eliminating the need for screws.
- Auto Device Replacement allows OEMs to add I/O modules without making changes to the control software.
- Built-in panel grounding.
- Electronic and mechanical keying prevents users from placing I/O modules in the wrong sequence.

Communication Modules

- A Communication Module supports up to a maximum of 63 I/O modules and up to 264 Inputs and 264 Outputs.



Steps for Specifying an ISYSNET System

1. Select a Communication Module
2. Select I/O Modules
3. Select Appropriate Power Unit
4. Select Cables and Cordsets
5. Determine Mounting Requirements for your isysnet Configuration.

ISYSNET Product Compatibility

	DeviceNet Adapter PSSCDM	ControlNet Adapter PSSCCNA	EtherNet Adapter PSSCENA	PROFIBUS Adapter PSSCPBA
PLC-5™ with Network Port	IOD	NS	NS	NA
SLC 500™ with Network Port	IOD	NS	NS	NA
PLC-5 Processor via Network Module	IOD	NS	NS	3
1756 Logix™ Communication Interface	IOD	IOD	IOD	3
PanelView™ Terminal	NA	NA	NA	NA
RSLinx™ Software	NA	NA	NA	NA
1769-L20, -L30 Controller with 1761- NET Interface	NA	NS	NS	NA
1769-L32E, -35E	NA	NA	IOD	NA
1769-L32C, -35CR	NA	IOD	NA	NA
1769 CompactLogix™ Communication Interface	IOD	NA	NA	3*
SoftLogix5800™ Communication Interface	IOD	IOD	IOD	3*
PC with RSLinx Only	NS	NS	NS	NA
FlexLogic™ Communication Interface	IOD	IOD	IOD	3

IOD = I/O Data

NS = Not Supported

NA = Not Applicable

3 = Requires third party scanner module

* Hilscher North America

Communication Considerations

ISYSNET features are impacted by your network choice.

Network	Impact
DeviceNet PSSCDM12A and PSSCDM18PA	The PSSCDM12A and PSSCDM18PA provide two means of connecting a node of I/O to DeviceNet. A total of 63 isysnet modules can be assembled on a single DeviceNet node. Expansion power supplies may be used to provide additional PointBus backplane current.
ControlNet™ PSSCCNA	A total of 63 isysnet modules can be assembled on a single ControlNet node. Expansion power supplies may be used to provide additional PointBus backplane current. Up to 25 direct connections and 5 rack connections are allowed.
EtherNet/IP™ PSSCENA	A total of 63 isysnet modules can be assembled on a single EtherNet / IP node. Expansion power supplies may be used to provide additional PointBus backplane current. Refer to the User Manual, publication PSS-UM004 to determine the ratings for direct and rack connections allowed.
PROFIBUS DP™ PSSCPBA	A total of 63 isysnet modules can be assembled on a single PROFIBUS node. Expansion power supplies may be used to provide additional PointBus backplane current.

ISYSNET Field Bus System

Centralised Solution

- A complete field bus communication offering for all ISO valves.
- UL, C-UL and CE certifications (as marked).

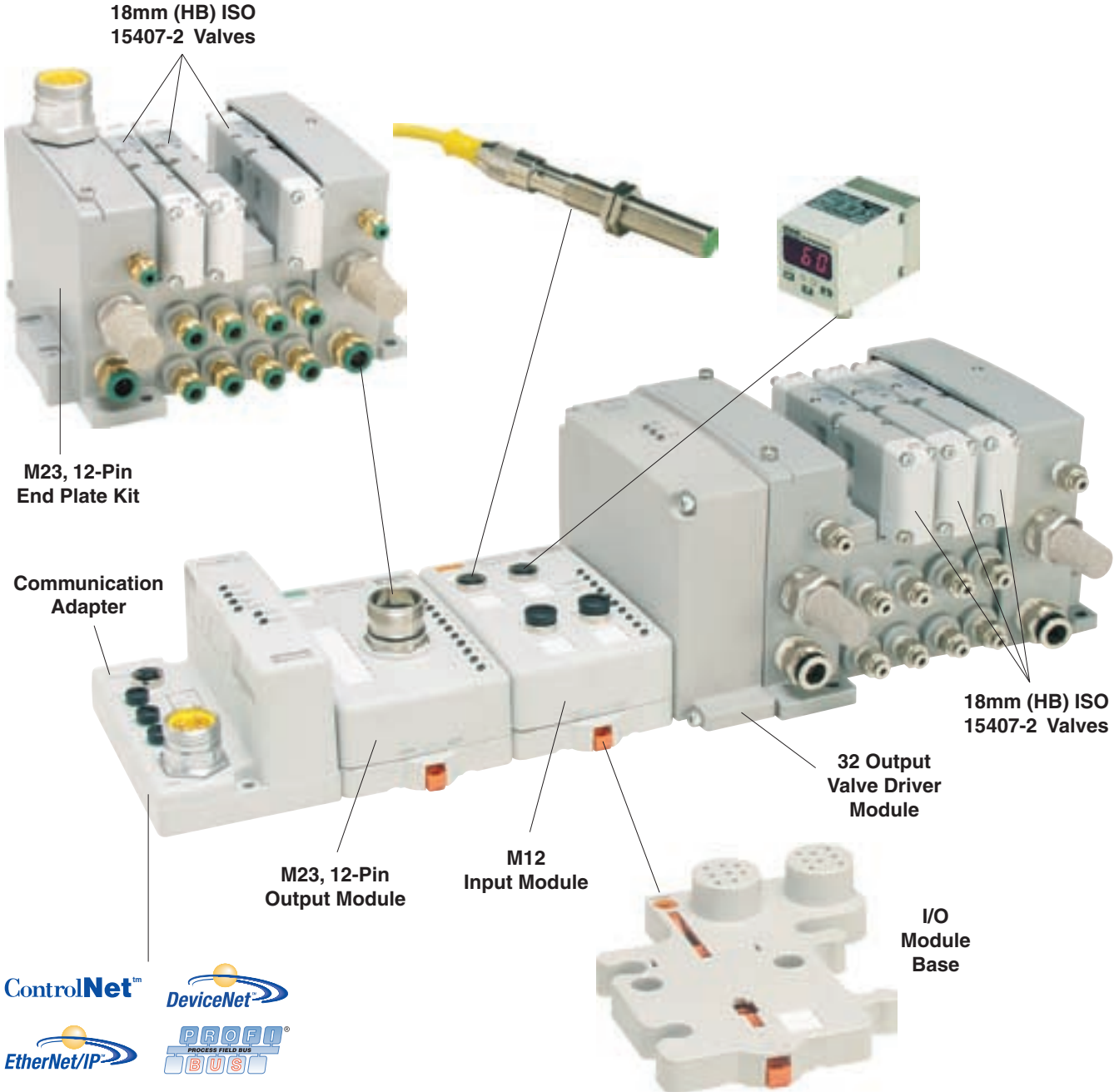

I/O Configuration

- Centralized isysnet system.
- Pneumatics and I/O are in close proximity to one another
- I/O density per module = 8.

ISYSNET Field Bus System

Distributed Solution

- A complete field bus communication offering for all ISO valves.
- UL, C-UL and CE certifications (as marked).

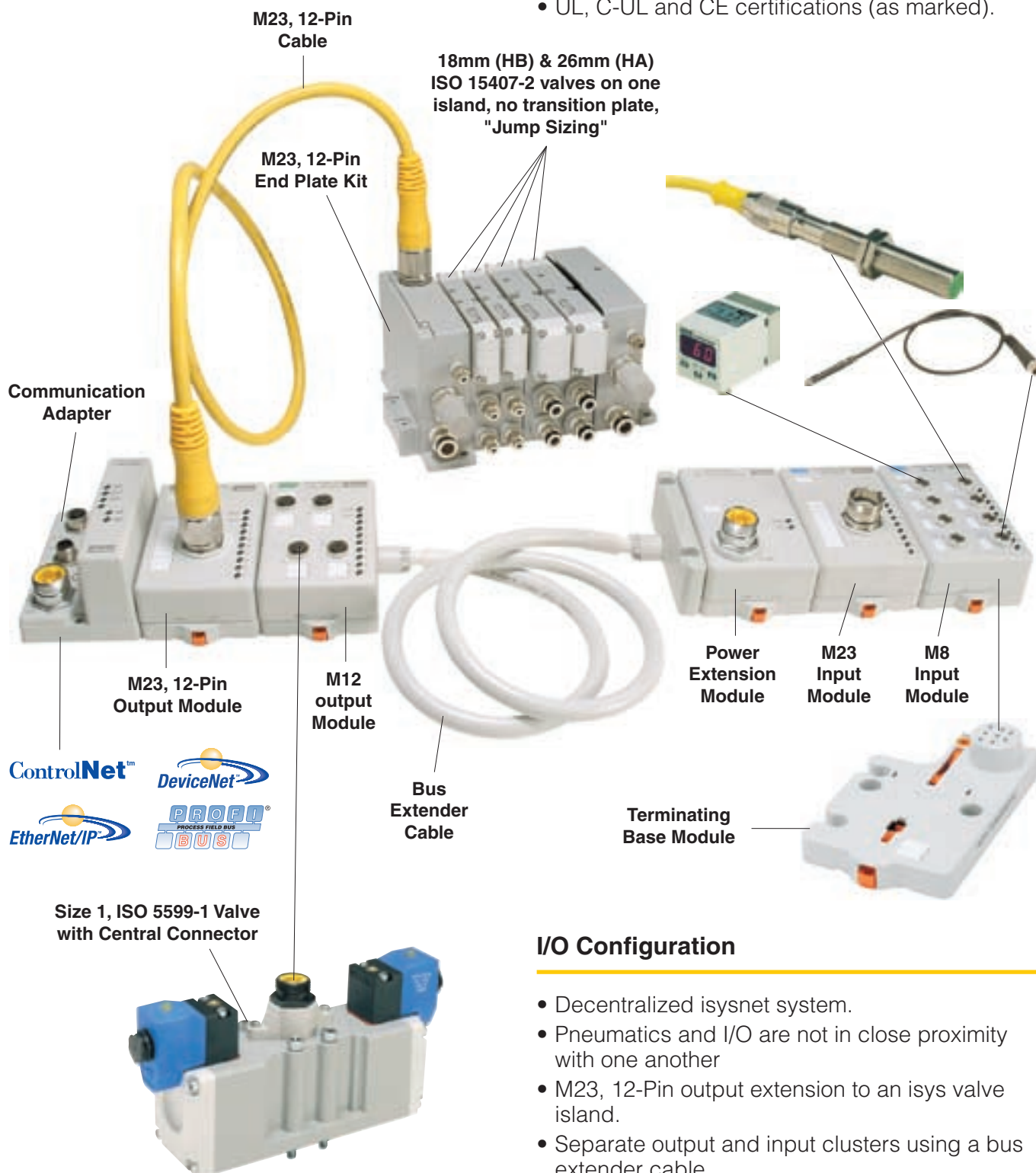

I/O Configuration

- Decentralized isysnet system.
- Pneumatics and I/O are not in close proximity with one another
- M23, 12-Pin output extension to an isys valve island.
- Separate output and input clusters using a bus extender cable.
- Separate output and input power using a power extension module.
- I/O density per module = 8.

Communication Modules



PSSCENA



PSSCCNA

†§ DeviceNet™ (M18 or M12)	PSSCDM18PA (M18) or PSSCDM12A (M12)	10 to 28.8VDC
†§ ControlNet™	PSSCCNA	10 to 28.8VDC
†§ Ethernet I/P™	PSSCENA	10 to 28.8VDC
†§ Profibus-DP®	PSSCPBA	10 to 28.8VDC

* IP67 Certified

† Reference the following Documents for Installation Instructions.
 DeviceNet - E101P, PSS-UM001A; ControlNet - E103P
 Ethernet I/P - E104P; Profibus-DP - E102P

§ Requires a PSST8M23A or PSSV32A in all manifold assemblies.
 PSSV32A is included in factory assembled manifolds and isysnet
 End Plate Kits.

EDS and GSD files located at www.parker.com/pneu/isysnet

I/O Modules



PSST8M12A



PSST8M23A



PSSNACM12A



PSSTACM12A



PSSN8M8A

† 8 Digital Inputs M12 on 4 M12 connectors for PNP Sensors	PSSN8M12A	10 to 28.8VDC
† 8 Digital Inputs M12 on 4 M12 connectors for NPN Sensors	PSSP8M12A	10 to 28.8VDC
† 8 Digital Inputs M8 for PNP Sensors	PSSN8M8A	10 to 28.8VDC
† 8 Digital Inputs M8 for NPN Sensors	PSSP8M8A	10 to 28.8VDC
+ 8 Digital Outputs M12 (PNP Sourcing)	PSST8M12A	10 to 28.8VDC
+ 8 Digital Outputs M8 (PNP Sourcing)	PSST8M8A	10 to 28.8VDC
§ 4 Digital Output, High Watt Relay M12 (PNP Sourcing) (2 Amp)	PSSTR4M12A	24VDC
+ #8 Digital Outputs M23 (PNP Sourcing)	PSST8M23A	10 to 28.8VDC
‡ 2 Analog Inputs Voltage (M12)	PSSNAVM12A	0 to 10V ± 10V
‡ 2 Analog Inputs Current (M12)	PSSNACM12A	4 to 20mA or 0 to 20mA
** 2 Analog Outputs Voltage (M12)	PSSTAVM12A	0 to 10V ± 10V
** 2 Analog Outputs Current (M12)	PSSTACM12A	4 to 20mA or 0 to 20mA

* IP67 Certified

Reference the following Documents for Installation Instructions.

† E106P § E109P **E111P

+ E107P **E111P

#Can be used with PSSTERM.

See www.parker.com/pneu/isysnet

Valve Driver Modules

32 Point Module – HB, HA, H1, H2, H3	PSSV32A^{††}
24 Output Cable – HB, HA	PS5624P[†]
25 - 32 Output Cable – HB, HA	PS5632P[†]
24 Output Cable – H1, H2, H3	PS4024P[†]

* Reference Document E100P for Installation Instructions.
 See www.parker.com/pneu/isysnet

† Isysnet Add-A-Folds assemblies and end plate kits include a valve driver module (PSSV32A) and cable.

HB / HA 24 output manifolds require a PS5624P.

HB / HA 32 output manifolds require a PS5624P + PS5632P.

H1, H2, H3 manifolds require a PS4024P, allowing 21 outputs.

Included in Kits:- **PS5620L61P**
PS4020L61CP



PSSV32A

Valve Driver Modules

Terminating Module	PSSTERM
--------------------	----------------

Used as the last Terminating Module for a Stand Alone isysnet Assembly.

A PSST8M23A must be located in the isysnet assembly.



PSSTERM

Power Extender Module

24VDC Field Power Module	PSSSE24A	24VDC
--------------------------	-----------------	-------

A Power Extender Module must be used on every 12th Module in an isysnet assembly. See www.parker.com/pneu/isysnet

Reference Document E105P and PSS-SG001 for configuration instructions. See www.parker.com/pneu/isysnet



PSSSE24A

Bus Extender Cable

1 Meter Cable*	PSSEXT1	24VDC
3 Meter Cable*	PSSEXT3	24VDC

* Requires a PSSSE24 Power Extender Module.

IP67 Certified

Reference the following Documents for Installation Instructions.
 E117P

See www.parker.com/pneu/isysnet



PSSEXT1

Solenoid operators - 15mm

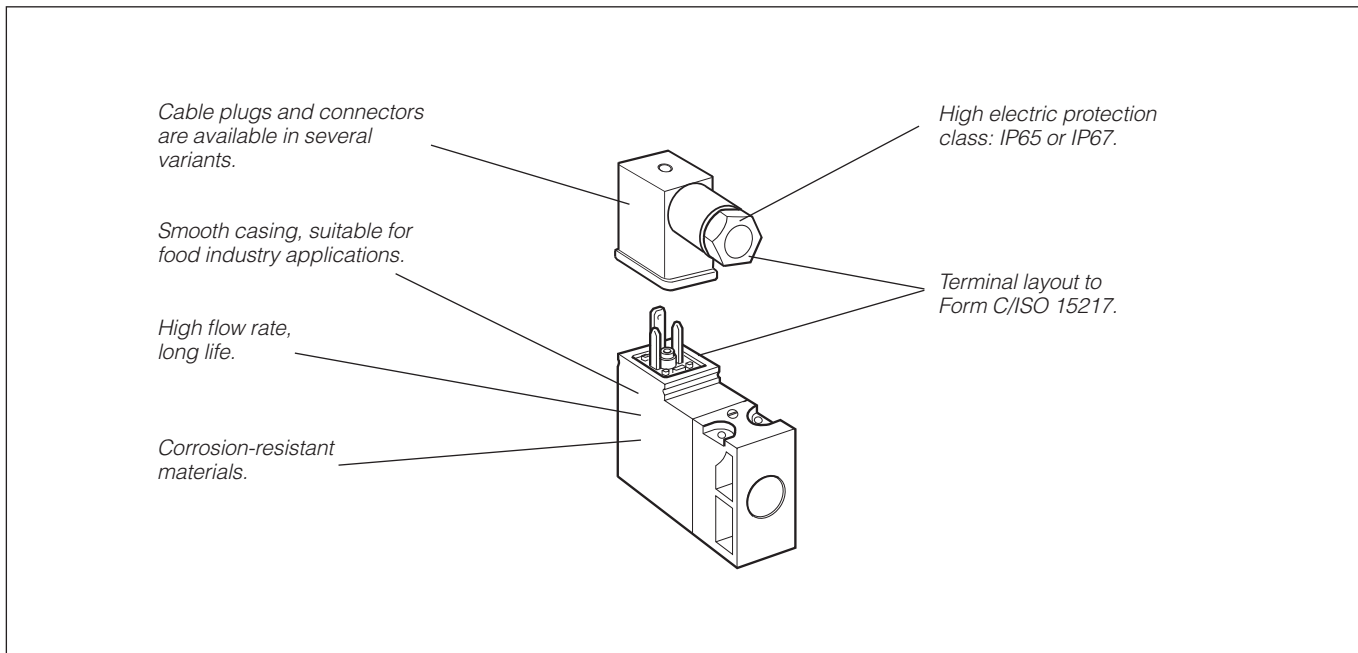

The P2E-•V solenoid operator range

The P2E-•V range of operators are normally closed (NC) 3/2 solenoid valves, with exceedingly compact dimensions in relation to their capacity.

International standard

The port connection pattern complies with a new French CNOMO standard (in process of drafting), with cable plug connections in accordance with Form C/ISO15217.

Compact design

Overall dimensions of the P2E-•V operators are substantially less than those of earlier generations of solenoid operators.

High flow capacity

High flow capacity relative to the electrical operating power as a result of optimised internal flow paths.

Corrosion-resistant design

The valve is made of thermoplastic material and stainless steel, with Viton™ and nitrile rubber seals for excellent corrosion resistance.

Clean lines suitable for food industry applications, P2E-QV

The valve has been designed in conjunction with several machine manufacturers and organisations in the food processing industry, with corrosion-resistant materials and smooth lines being important starting points. The valve and its accessories have been designed so that there are no gaps or crevices in which dirt could collect.

High reliability

Few moving parts result in high reliability, rapid changeover and very long life.

Low power demand

The solenoids have a power demand of 1.2 W at 24 V DC and 1.6 VA at 24 V AC, 115 V AC and 230 V AC.

Insensitive to dirty air

The use of generously sized flow paths (1.0 mm diameter) means that the valve can be used in normal industrial environments without problems of blocking.

Manual override as option

The operators can be supplied with or without manual override. The manual override device is available as a screwdriver groove or with a control arm, and is either spring return (blue) or lockable (yellow).

Order key, solenoid operators (15mm)

P 2 E -	Q	V	3	2	C	3
----------------	----------	----------	----------	----------	----------	----------

Valve family	
P2E	Solenoid operator

Subfamily	
Solenoid operator, 15 mm wide Electric connection acc. to ISO 15217 Form C EI/supply connection on opposite side	
K	Standard version
M	Mobile version
Q	Food industry version

Type of current	
1	AC 50 Hz
2	DC
4	AC 50/60 Hz
5	Mobile and wide band only

Voltage	
B	12 V
C	24 V
D	48 V
F	115 V*
J	230 V*
W	37,5 V**
T	72 V**
Y	78 V**
V	96 V**
E	110 V**

Overrides	
0	Without
1	Non locking (blue)
2	Locking (yellow)
3	Extended non locking (blue)
4	Extended locking (yellow)

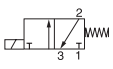
Valvetype/Function	
3	 3/2 valve, normally closed (NC)

* For standard and food type only
 ** For mobile "M" version only

Technical data

	NC, Standard	NC, Food¹⁾	NC, Mobile²⁾
Working pressure	0 to 10 bar	0 to 10 bar	0 to 10 bar
Working temperature	-15 °C to +60 °C	-15 °C to +60 °C	-40 °C to +70 °C
Orifice	1,0 mm	1,0 mm	1,0 mm
Flow Qmax	33 NI/min	33 NI/min	22 NI/min
Power, hold	DC 1,2 W / AC 1,6 VA	DC 1,2 W / AC 1,6 VA	DC 1 W
Power, surge	DC 1,2 W / AC 3,5 VA	DC 1,2 W / AC 3,5 VA	DC 1 W
Connection time	100%	100%	100%
Voltage tolerance	+10%/-15%	+10%/-15%	+25%/-30%
Electric connection:	Form C/ISO15217		
Port pattern:	To future CNOMO standard		
Protection:	IP 65 - IP 67, depending on type of cable plug		
Approval:	Standard solenoids are UL-approved and marked with the following symbol 		
Working media:	All neutral media, such as compressed air, water, hydraulic oil and many gases.		
1) Design:	Completely smooth exterior, suitable for food industry.		
2) Mobile standard	According to European standard EN 50 155.		

Transients

Interrupting the current through the solenoid coil produces momentary voltage peaks which, under unfavourable conditions, can amount to several hundred times the rated operating voltage. Normally, these transients do not cause problems, but to achieve the maximum life of relays in the circuit (and particularly of transistors, thyristors and integrated circuits) it is desirable to provide protection by means of voltage-dependent resistors (varistors). All cable plugs with a yellow LED also incorporate such protection.

Service life

With compressed air at 6 bar, 20 °C and complying with the requirements for compressed air quality as set out in ISO8573-1 norm (class 4 for dry and class 5 for filtered air), the valves should have a life of at least 50 million cycles.

Materials

Operator

Body, coil casing	Thermoplastic
Internal metal parts	Steel
Screws	Stainless steel
Bottom plug	Thermoplastic
Sealing materials	FPM (Viton™) and nitrile rubber

Cable head

Sheath	Thermoplastic
Retaining screw	Stainless steel, zinc-plated steel

Solenoid Operators - 15mm

Electrical connection EN175301-803 C/ISO15217 (Ex DIN 43650C)

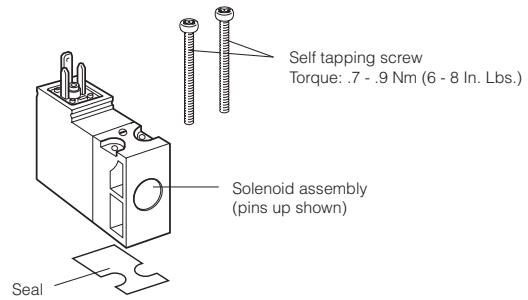

Solenoids 15 mm NC, standard

(Note! Mounting screws included in basic valve)

	Voltage	Weight Kg	Order code		Weight Kg	Order code		
			Without manual override	Override, blue, non locking flush		Without manual override	Override, yellow, locking flush	
	12 VDC	0,038	P2E-KV32B0	0,038	P2E-KV32B1	0,038	P2E-KV32B2	
	24 VDC	0,038	P2E-KV32C0	0,038	P2E-KV32C1	0,038	P2E-KV32C2	
	48 VDC	0,038	P2E-KV32D0	0,038	P2E-KV32D1	0,038	P2E-KV32D2	
	24 VAC 50Hz	0,038	P2E-KV31C0	0,038	P2E-KV31C1	0,038	P2E-KV31C2	
	48 VAC 50/60Hz	0,038	P2E-KV34D0	0,038	P2E-KV34D1	0,038	P2E-KV34D2	
	115 VAC 50Hz/ 120 VAC 60Hz	0,038	P2E-KV31F0	0,038	P2E-KV31F1	0,038	P2E-KV31F2	
	230 VAC 50Hz/ 240 VAC 60Hz	0,038	P2E-KV31J0	0,038	P2E-KV31J1	0,038	P2E-KV31J2	
	Voltage		Order code		Weight		Order code	
			Without manual override	Override extended, blue, non locking flush	Kg	Kg	Without manual override	Override extended, yellow, locking flush
	24 VDC	0,038	P2E-KV32C3	0,038	P2E-KV32C4			
24 VAC 50Hz	0,038	P2E-KV31C3	0,038	P2E-KV31C4				

Solenoids 15 mm NC, mobile

(Note! Mounting screws included in basic valve)

	Voltage	Weight Kg	Order code	
			Without manual override	Override, blue, non locking flush
	12 VDC	0,038	P2E-MV35B0	P2E-MV35B1
	24 VDC	0,038	P2E-MV35C0	P2E-MV35C1
	37,5 VDC	0,038	P2E-MV35W0	P2E-MV35W1
	48 VDC	0,038	P2E-MV35D0	P2E-MV35D1
	72 VDC	0,038	P2E-MV35T0	P2E-MV35T1
	78 VDC	0,038	P2E-MV35Y0	P2E-MV35Y1
	96 VDC	0,038	P2E-MV35V0	P2E-MV35V1
	110 VDC	0,038	P2E-MV35E0	P2E-MV35E1

Solenoids 15 mm NC, food industry version

(Note! Mounting screws included in basic valve)

	Voltage	Weight Kg	Order code		Weight Kg	Order code		
			Without manual override	Override, blue, non locking flush		Without manual override	Override, yellow, locking flush	
	24 VDC	0,038	P2E-QV32C0	0,038	P2E-QV32C1	0,038	P2E-QV32C2	
	48 VDC	0,038	P2E-QV32D0	0,038	P2E-QV32D1	0,038	P2E-QV32D2	
	24 VAC 50Hz	0,038	P2E-QV31C0	0,038	P2E-QV31C1	0,038	P2E-QV31C2	
	48 VAC 50/60Hz	0,038	P2E-QV34D0	0,038	P2E-QV34D1	0,038	P2E-QV34D2	
	115 V 50Hz/ 120 V 60Hz	0,038	P2E-QV31F0	0,038	P2E-QV31F1	0,038	P2E-QV31F2	
	230 VAC 50Hz/ 240 VAC 60Hz	0,038	P2E-QV31J0	0,038	P2E-QV31J1	0,038	P2E-QV31J2	
		Voltage		Order code		Weight		Order code
		Without manual override	Override extended, blue, non locking flush	Kg	Kg	Without manual override	Override extended, yellow, locking flush	
24 VDC		0,038	P2E-QV32C3	0,038	P2E-QV32C4			
24 VAC 50Hz		0,038	P2E-QV31C3	0,038	P2E-QV31C4			
115 VAC 50 Hz		0,038	P2E-QV31F3	0,038	P2E-QV31F4			
230 VAC 50 Hz	0,038	P2E-QV31J3	0,038	P2E-QV31J4				

In accordance with the EU Machine Directive, EN 983, solenoid valves with manual override should have spring-return operating arms for safety.

Solenoid operators - CNOMO

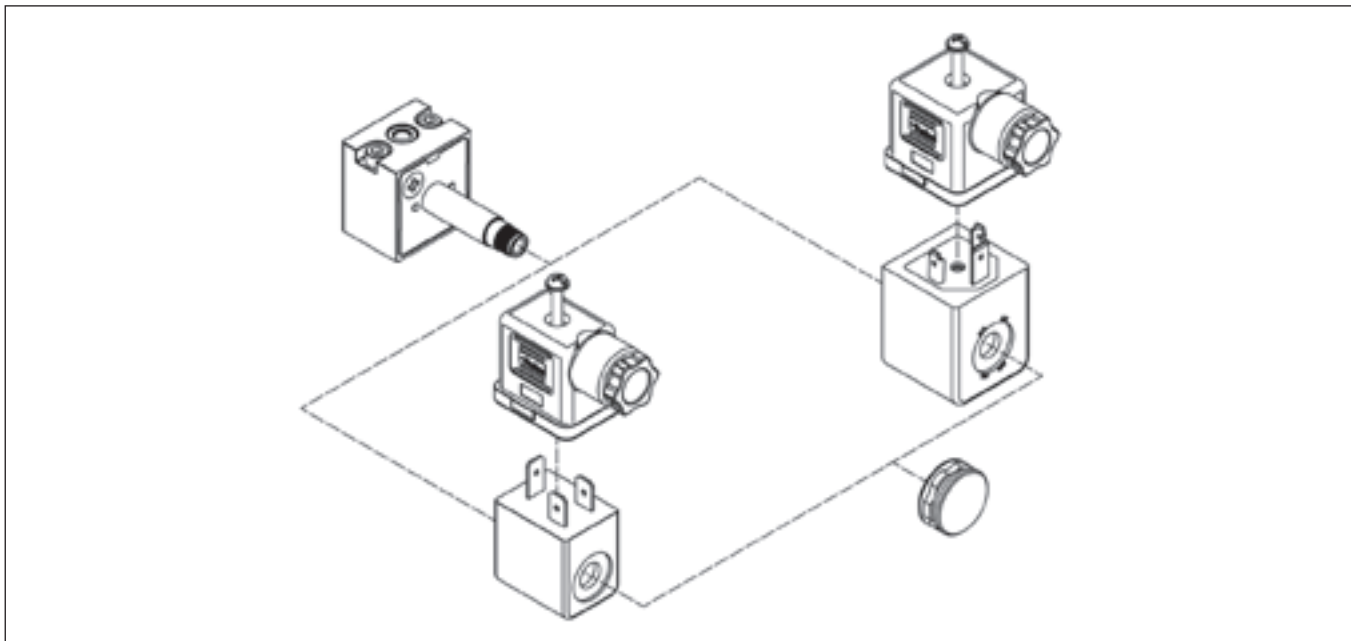

CNOMO Solenoid pilot options

The P2F P23*** (NC) 3/2 solenoid pilot operators are designed for piloting pneumatic control valves with compressed air or inert gases.

The P2F P operator is available for operating pressures up to 10 bar having an outlet orifice 1,3 mm and exhaust orifice 1,5 mm. Alternative operators are also available for an operating pressure up to 16 bar, or for a wide band voltage tolerance requires for mobile application.

Metal CNOMO Solenoid pilot for railway

An alternative operator, metal casting is also available for heavy duty or railway applications.

This P2F P operator is available for operating pressures up to 10 bar having an outlet orifice 1,3 mm and exhaust orifice 1,5 mm, and compatible with a wide range of coil, having a wide band voltage tolerance.

Corrosion resistant design

The pilot operator body is manufactured in thermoplastic PA 6.6 material and the core tube brass/stainless steel. The plunger/core is made from stainless steel and the valve seats from FKM.

Coils

Coils are wound with enameled copper wire, class H temperature class F insulation (155°C) and are encapsulated in Thermoplastic. When fitted with suitable connector and correct gasket they give protection to IP65.

Solenoid Pilot Exhaust

These operators all exhaust out of the top of the core tube which is tapped M5. The standard solenoid nut fitted to the core tube is the Diffuser nut which allows the exhaust to escape to atmosphere. This nut also minimises ingress of dirt into the valve through this port. The alternative plastic knurled nut can be specified (refer to part number system) if the exhaust air needs to be captured and piped away using the M5 tapped port.

Mobile Applications

ISO valves are tested to +5g shock and vibration. Solenoid operated valves are designed to operate with extended voltage tolerance bands within the ambient temperature ranges stated in the technical section.

Manual Override options

The pilot operators can be supplied with or without manual override. The standard manual override is the monostable (spring return) flush brass override. Alternatively the bistable (locking) override can be specified as an alternative for the Normal duty 10bar option.

Spares

Solenoid operators are available as spares complete with mounting screws. Coils and connectors should be ordered separately.

Solenoid operators - CNOMO

Order key

P 2 F

P

2

Operator Type	
2	CNOMO 22 x 30 Plastic
4	CNOMO 22 x 30 Metal

3

N

4

Pressure / Temp	
M	10 bar / -25°C to +50°C
N	10 bar / -10°C to +50°C
H	16 bar / -40°C to +60°C

C

Manual / Override	
A	Without manual override
B	Non locking - monostable - Flush - Brass
C	Locking - bistable - Flush - Plastic



Note: 'C' only suitable for 'N' Pressure / Temp

Technical data - Solenoid operators, coil combinations

	NC Normal Operator with 30 x 30 standard coil	NC Normal Operator with 22 x 30 standard coil	NC Mobile Metal Operator with 30 x 30 mobile coil
Working pressure	0 to 10 bar	0 to 10 bar	0 to 10 bar
Ambient temperature	-10 °C to 60 °C (1)	-10 °C to 60 °C (1)	-25 °C to 60 °C (1)
Orifice	1.3/1.5mm	1.3/1.5mm	1.2/1.3mm
Flow Qn	0.84 dm ³ /s	0.84 dm ³ /s	0.7 dm ³ /s
Power (DC)	2.7W	4.8W	6.8W
Power (AC)	4.9VA	8.5VA	10.5VA
Voltage tolerance	+/- 10%	+/- 10%	+/- 30%
Duty cycle	100%	100%	100%
Insulation class	F	F	F
Electric connection	Din A	Industrial	Din A
Protection	IP65	IP65	IP65
Shock & Vibration	1g	1g	5g
Approval	UL/CSA (Optional)		
Working media	All neutral media such as compressed air and inert gases.		

(1) limited to 50°C if use with 100% duty cycle

Mobile applications

Solenoid operated ISO valves for Mobile applications are fitted with the P2FP43M4A solenoid pilot operator. It has a 22x30 footprint with 1.2/1.3 orifice and will accept 22mm or 30mm coil options. The choice of coil option will depend on the voltage tolerance. Use the technical data in the table above before selecting the coil type required, or contact our technical department.

Transients

Interrupting the current through the solenoid coil produces momentary voltage peaks which, under unfavourable conditions, can amount to several hundred times the rated operating voltage. Normally, these transients do not cause problems, but to achieve the maximum life of relays in the circuit (and particularly of transistors, thyristors and integrated circuits) it is desirable to provide protection by means of voltage-dependent resistors (varistors). All connectors/cable plugs EN175301-803 with LED's include this type of circuit protection.

Materials

Pilot Valve	Standard	Mobile
Body:	Polyamide	Aluminium
Armature tube:	Brass	Stainless steel
Plunger & core:	Corrosion resistant Cr-Ni steel	
Seals:	FKM (Viton™)	Low temp FKM
Screws:	Zinc plated	Stainless steel

Coil

Encapsulation material:	Thermoplastic as standard thermoset resin for M12 connection
-------------------------	---

Solenoid coils with Din A or Industrial connection

Voltage	Order code Din A Standard 30 x 30	Weight (Kg)	Order code Din A Mobile 30 x 30	Weight (Kg)	Order code Industrial standard 22 x 30	Weight (Kg)
Direct current						
12V DC	P2FCA445	0.105	P2FCA447	0.105	P2FCB445	0.093
24V DC	P2FCA449	0.105	P2FCA448	0.105	P2FCB449	0.093
48V DC	P2FCA453*	0.105	P2FCA474	0.105	P2FCB451	0.093
72V DC			P2FCA470	0.105		
96V DC			P2FCA471	0.105		
110V DC			P2FCA472	0.105		
Alternative current						
12V 50/60Hz	P2FCA440	0.105			P2FCB440	0.093
24V 50/60Hz	P2FCA442	0.105			P2FCB442	0.093
48V 50/60Hz	P2FCA469#	0.105				
110V 50Hz, 120V 60Hz	P2FCA453	0.105			P2FCB453	0.093
230V 50Hz, 230V 60Hz	P2FCA457	0.105			P2FCB457	0.093

* P2FCA453 is compatible with 110 V AC and 48 V DC

P2FCA469 is 24 V DC 6.8W or 48 V 50Hz 9.9 VA

Solenoid coils with M12 connection

Voltage	Order code 30 x 30	Weight (Kg)	Order code 22 x 30	Weight (Kg)
Direct current				
24V DC	P2FC6419	0.065	P2FC7419	0.065

Spare Solenoid Nuts

Valves requiring captured exhaust should be fitted with plastic knurled nut

Order code

P2FNP

Valves with vented exhaust are fitted with diffuser plastic nut

Order Code

P2FND

Spare Solenoid Operators

Solenoid pilot operator CNOMO NC



Description	Order code No manual override	Weight (Kg)	Order code Non-lock manual override	Weight (Kg)	Order code Locking manual override	Weight (Kg)
Standard duty	P2FP23N4A	0.065	P2FP23N4B	0.065	P2FP23N4C	0.065
Mobile metal	P2FP43M4A	0.1				

Note.

Solenoid pilot operators are fitted to the Viking valve range. Order the above part numbers for spares. The operators are supplied with mounting screws and interface 'O' rings.

Coils and connectors must be ordered separately.

Solenoid Connectors / Cable Plugs EN175301-803

	Description	Order code 15mm Form C/ISO15217	Order code 22mm Industrial Form B	Order code 30mm Form A/ISO4400
With large headed screw suitable for mounting in inaccessible or recess position 	Standard IP65	P8C-C		
	24V DC LED and protection IP65	P8C-C26C		
	110V AC LED and protection IP65	P8C-C21E		
With standard screw 	Standard IP65 without flying lead	P8C-D	3EV10V10	3EV290V10
	With LED and protection 24V AC/DC	P8C-D26C	3EV10V20-24	3EV290V20-24
	With LED and protection 110V AC	P8C-D21E	3EV10V20-110	3EV290V20-110
	With LED and protection 230V AC		3EV10V20-230	3EV290V20-230
With cable 	Standard with 2m cable IP65	P8L-C2		
	Standard with 5m cable IP65	P8L-C5		
	24V AC/DC, 2m cable LED and protection IP65	P8L-C226C		
	24V AC/DC, 5m cable LED and protection IP65	P8L-C526C	3EV10V20-24L5	3EV290V20-24L5
	24V AC/DC, 10m cable LED and protection IP65	P8L-CA26C		
	110V AC/DC, 2m cable LED and protection IP65	P8L-C221E		
	110V AC/DC, 5m cable LED and protection IP65	P8L-C521E	3EV10V20-110L5	3EV290V20-110L5
	230V AC, 5m cable LED and protection IP65		3EV10V20-230L5	3EV290V20-230L5

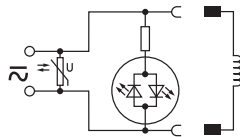
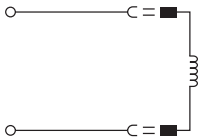

P8C-C
P8C-D
P8L-C2
P8L-C5
3EV10V10

P8C-D26C	P8L-C226C
P8C-D21E	P8L-C526C
P8C-C26C	P8L-CA26C
P8C-C21E	P8L-C221E
	P8L-C521E
3EV10V20-24	3EV10V20-24L5
3EV10V20-110	3EV10V20-110L5
3EV10V20-230	3EV10V20-230L5

Global ISO Series Valves

Cable Plug Dimensions (mm)

Solenoid operators P2E - 15mm

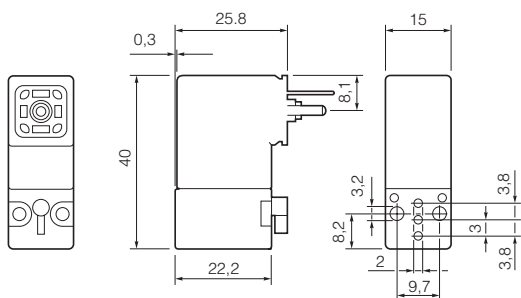

Solenoid operators P2F - CNOMO - 22 x 30mm



Cable plugs

- P8L-C2
- P8LC5
- P8L-C226C
- P8L-C526C
- P8L-CA26C
- P8L-C221E
- P8L-C521E

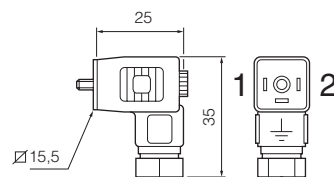

Cable plugs

- P8C-C
- P8C-C26C
- P8C-C21E
- P8C-D
- P8C-D26C
- P8C-D21E

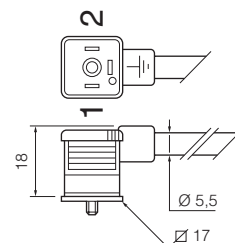

Cable plugs

- 3EV10V10

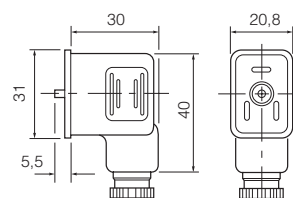

Cable plugs

- 3EV290V10

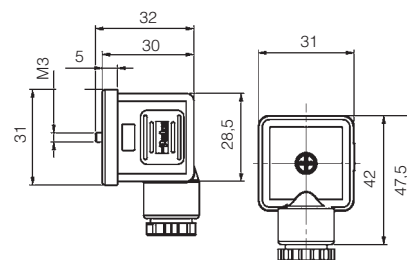

Accessories

Silencers

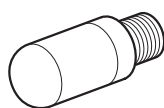

Port	Ordercode	Pack Qty
G1/8	P6M-PAB1	10
G1/4	P6M-PAB2	10
G3/8	P6M-PAB3	10
G1/2	P6M-PAB4	10

Fittings

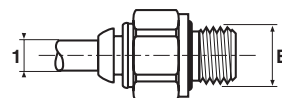

Male connector - BSPP

Tube dia 1	Thread	Ordercode	Box Qty
	B		
4	1/8	F4PMB4-1/8	20
4	1/8	F4PMB4-1/8	20
6	1/8	F4PMB6-1/8	30
8	1/8	F4PB8-1/8	40
6	1/4	F4PMB6-1/4	30
8	1/4	F4PB8-1/4	30
10	1/4	F4PB10-1/4	20
12	1/4	F4PB12-1/4	10
8	3/8	F4PB8-3/8	20
10	3/8	F4PB10-3/8	20
12	3/8	F4PB12-3/8	10
14	3/8	F4PB14-3/8	10
10	1/2	F4PB10-1/2	10
12	1/2	F4PB12-1/2	10
14	1/2	F4PB14-1/2	10

Global ISO Series Valves

Isomax - Dimensions (mm)

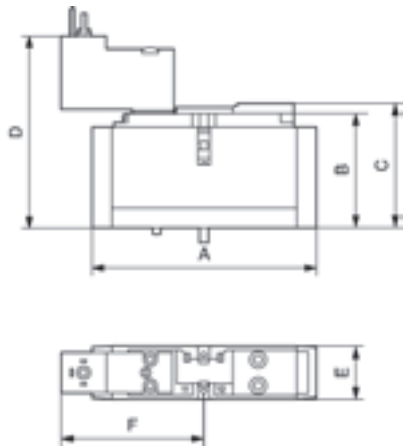

Pneumatically actuated

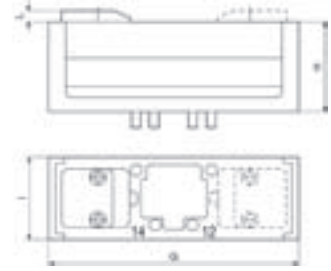

With P2F solenoids

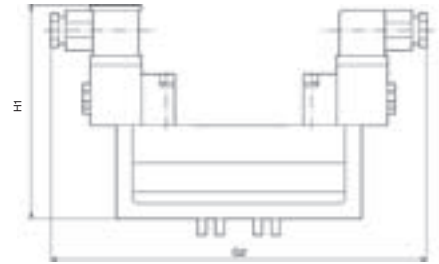

	A	B	C	D	E	F
Isomax 02	80	41	44,5	67,8	18	51,2
Isomax 01	100	42	45,5	68,8	26	51,2

	G	G1	G2	G3	H	H1	I	L
Size 1	120	164	202,5	160	47	119	42	5
Size 2	140	179,5	218	175,5	58,5	130	54	5
Size 3	170	198	235,5	194	71	142,5	68	5

Single subbases side ported

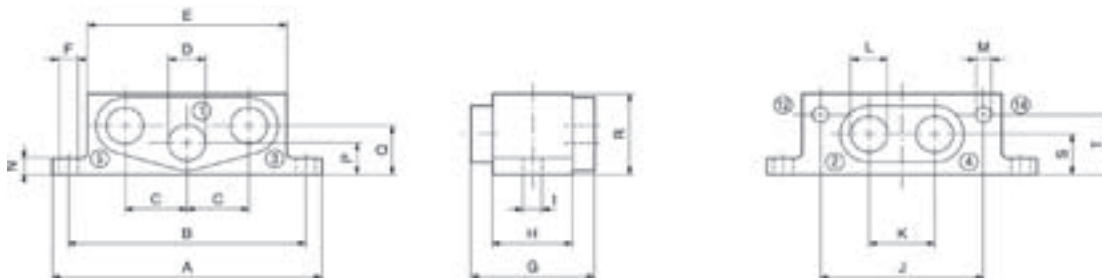

	Size	A	B	C	D	E	F	G	H	I	J	K	L	M	N	P	Q	R	S	T
PL02-01-70	02	80	70	16	G1/8	52	8	27	19	5,5	40	17	G1/8	M5	8	8	8	22	13	6
P2V-BS512SS	01	92	80	21,2	G1/8	68	6,5	42	27	5,5	55	22	G1/8	M5	6	11	17	28	14	21

Side ported manifolds for 2 valve positions

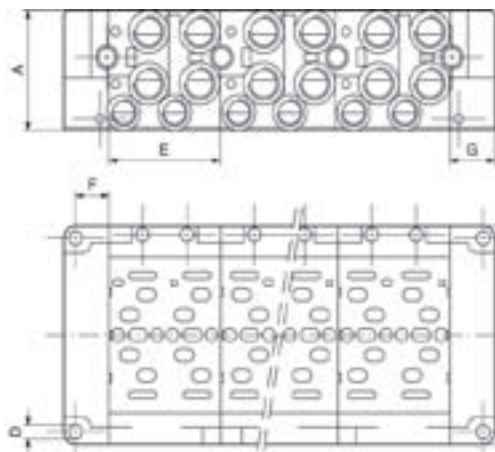

	Size	A	B	C	D	E	F	G	H
PJLP02-201-70	02	38,5	80	12	Ø 4,2	38	14	18	72
PJLP01-201-70 PJLP01-202-70	01	55	100	24	Ø 5,5	54	17	22	90

Bottom ported manifolds for 2 valve positions

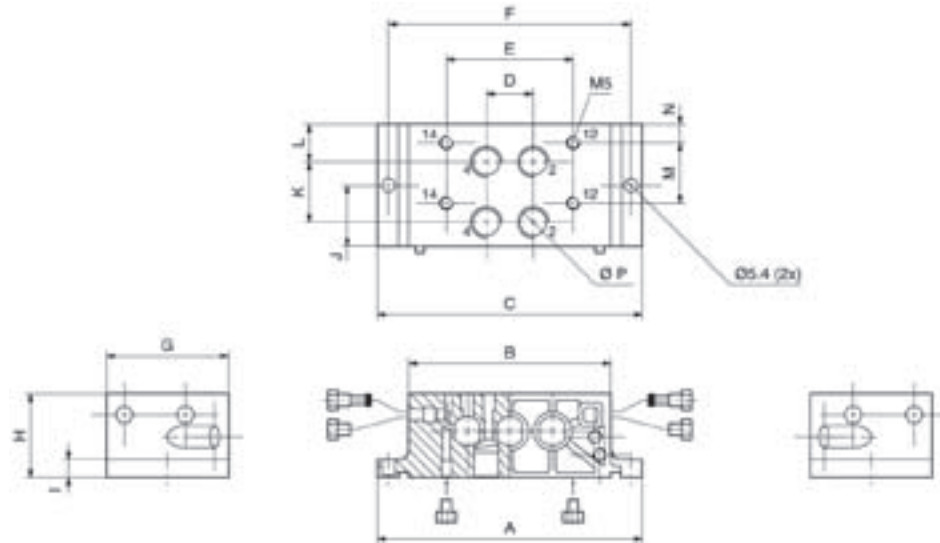

	Size	A	B	C	D	E	F	G	H	I	J	K	L	M	N	P
P2V-AM511PB	02	102	74	74,6	16	43	92	38	26	7	19	19	11	19	5	G1/8
P2V-BM512PB	01	118	90	90,6	21	56,5	108	54	37	8	27	27	16,5	27	8	G1/4

G and H side end plate bottom ported for above bottom ported manifold

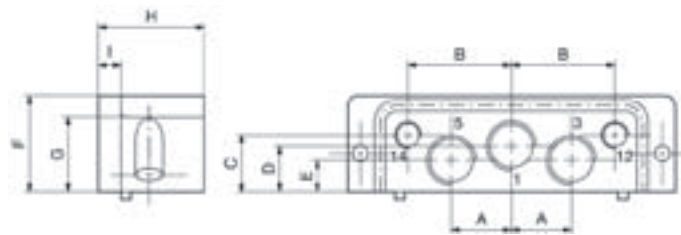

	Size	Port size 1,2,3	Port size 12, 14	A	B	C	D	E	F	G	H	I
P2V-AM512GB and P2V-AM512HB	02	G1/4	G1/8	17	29	21	18,5	9,5	35,5	28	33	7
P2V-BM513GB and P2V-BM513HB	01	G3/8	G1/8	21,5	37	20	16	11	34,5	28	38	8

Transfer plate size 01 to size 02 for above bottom ported manifold

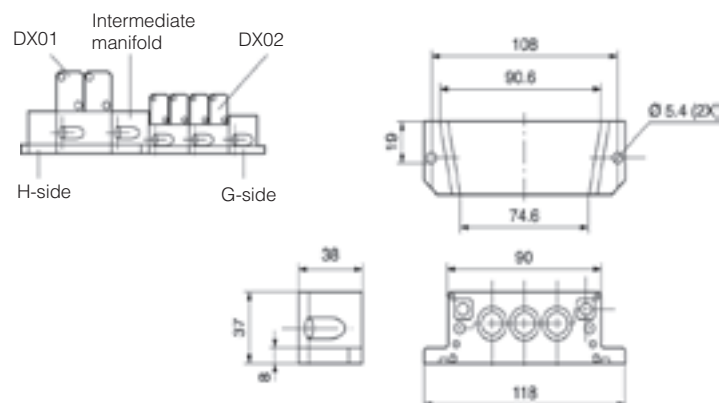

Single subbase with side ports according to VDMA - Dimensions

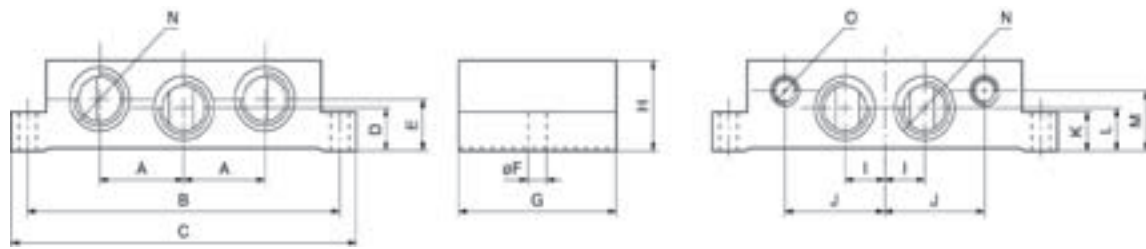

Order code	Size ISO	Port Size	A	B	C	D	E	F	G	H	I	J	K	L	M	N	O
P2N-VS512SD	1	G1/4	21,5	98	110	11	20	5,5	48	32	12	29	10	11	23	G1/4	G1/8
P2N-WS513S	2	G3/8	28	112	124	14	26	6,6	56	40	15	37	13	14	30	G3/8	G1/8
P2N-YS514SD	3	G1/2	34	136	149	17	17	6,6	71	32	16	45	18	17	22	G1/2	G1/8

Single subbase with side ports

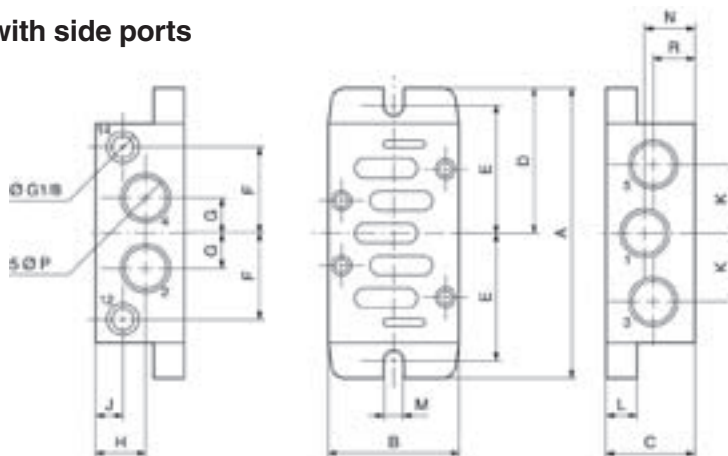

Order code	ISO Size	ØP	A	B	C	D	E	F	G	H	J	K	L	M	N	R
PL1-1/4-70	1	G1/4	110	46	29	55	49	30	11	17,75	17,75	22	6	5,5	17,75	17,75
PL2-3/8-70	2	G3/8	124	56	37	62	55	37	14,5	22,5	14	28	6	5,5	22,5	14,5
P2N-JS516SD	3	G3/4	149	71	60	74,5	68	45	21	33	10	40	18	6,6	37,5	22,5

Single subbase with bottom ports

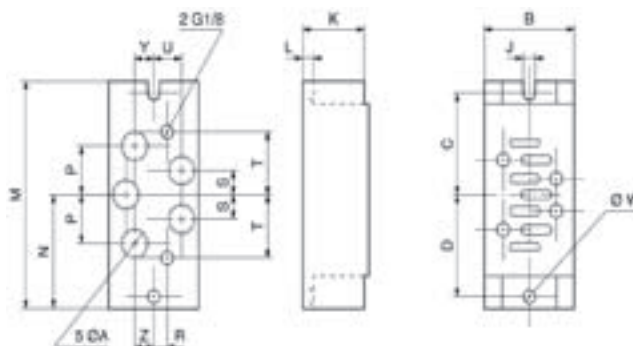

Order code	A	B	C	D	J	K	L	M	N	P	R	S	T	U	W	Y	Z
PD1-1/4-70	G1/4	46	49	49	5,5	29	6	110	55	22	10	11	30	10	5,5	10	10
PD2-3/8-70	G3/8	56	55	55	5,5	37	6	124	62	29	10	14,5	37	12,5	5,5	12,5	12,5
PD3-1/2-70	G1/2	77	68	68	6,6	32	18	149	74,5	34	10	17	45	17	6,5	17	17

Manifold and end plates according to VDMA (P2N-VM / WM / YM) - Dimensions

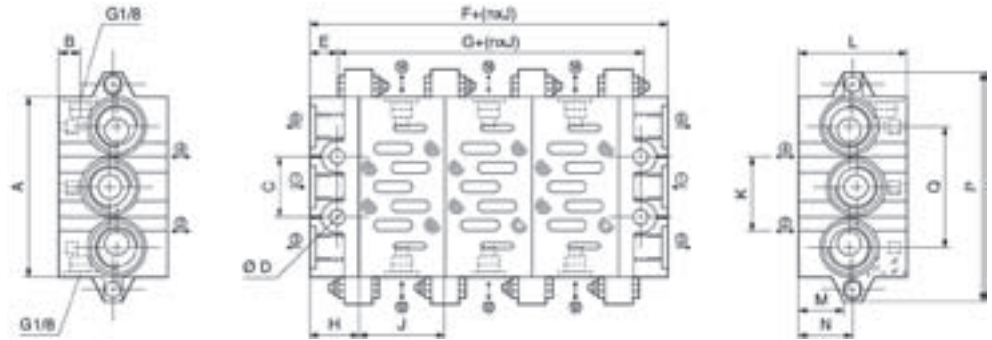

ISO Size	Port 1, 3, 5	Port 2, 4	A	B	C	D	E	F	G	H	J	K	L	M	N	O	P
1	G3/8	G1/4	85	8,5	28	7	11	44	22	22	43	26	46	21	24	56	110
2	G1/2	G3/8	100	9	35	9	13	52	26	26	56	30	47	22	24	68	135
3	G1	G1/2	140	10	52	12	15	60	30	30	71	38	56	31	34	104	190

Manifold and end plates with bottom ports "low profile" (P2N-AM..)

Manifold P2N-AM512MB

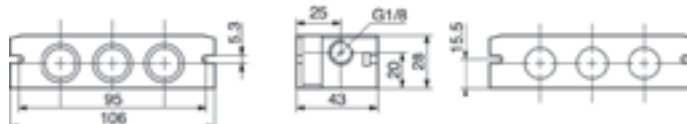

Connecting block P2N-AM513GT

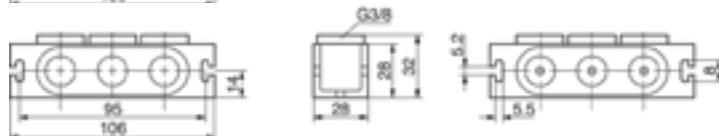

End piece P2N-AM500J

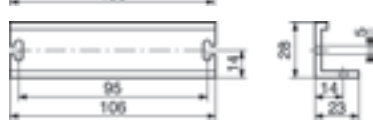

Intermediate supply P2N-AM513BT

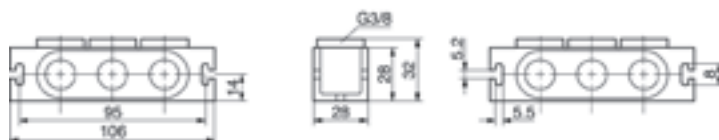

Manifold and end plates with side ports (P2N-EM / FM..)

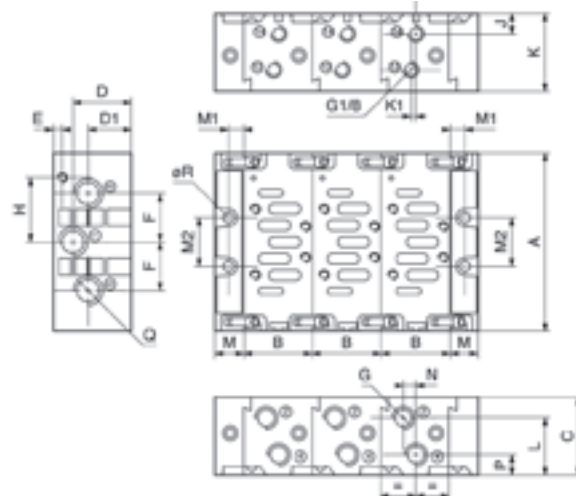

Order code	A	B	C	D	D1	E	F	G	H	J	K	K1	L	M	M1	M2	N	P	Q	R
P2N-EM ...	110	43	48	35,5	26,5	5,5	28	G1/4	36	15,5	35	3	32	20	11	28	12	12,5	G3/8	6
P2N-FM ...	129	56	60	44,5	35,5	6	34,5	G3/8	45	16	41,5	3	41	24	13	35	12,5	16	G1/2	8

Isysnet Field Bus System - Dimensions

15407-2 Series Valves

H1 / H2 / H3 Series Valves 5599-2

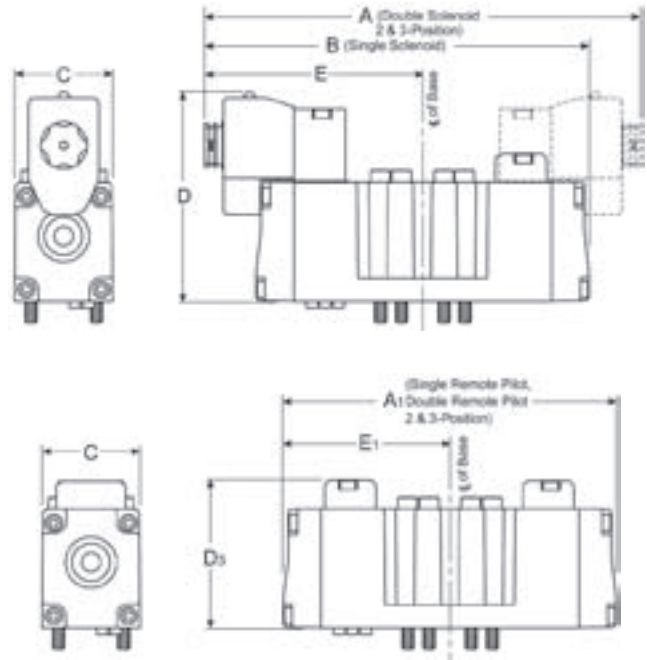
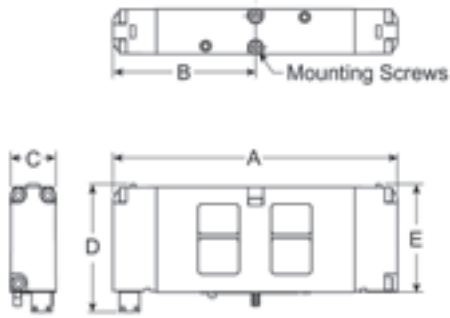

	A	B	C	D	E
HB	113	56	18	50	43
HA	130	65	26	50	42

	A	A ₁	B	C	D	D ₁	D ₂	D ₃	D ₄	E	E ₁
H1	186	142	164	42	90	109	109	63.5	63	93	71
H2	212	168	190	55	103	122	116	76		106	84
H3	241	177	209	55	103	122	116	76		121	89

Isysnet Field Bus System - Dimensions

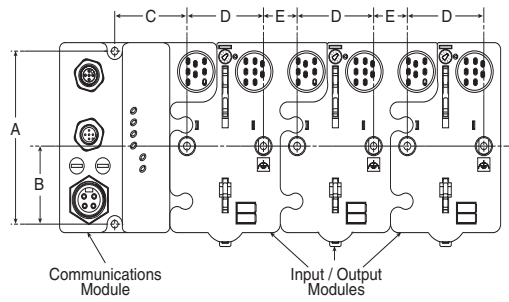

HB-HA
Dimensions

A	B	C	D
102	46	48	51
E	F		
22	11		

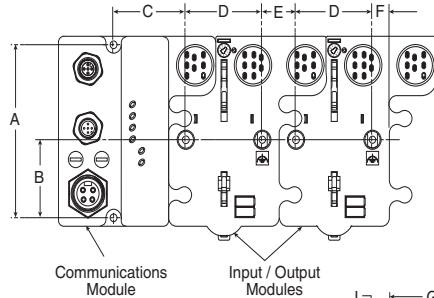

n = Number of 18mm HB Bases
 n1 = Number of 26mm HA Bases
 W = Width of 18mm HB Bases
 W1 = Width of 26mm HA Bases

HB-HA
Dimensions

A	B	E	L	G
152	137	7.5	106	68
H	H₁	J	K	L
8.4	45.8	4	110	16
M	P	W	W₁	
137	152	40.8	56.8	

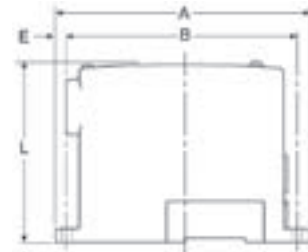
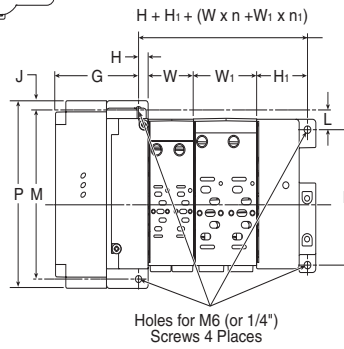

H1
Dimensions

G	H	H₁	J	K
56	15.9	15.9	8.5	165
P	W			
182	49			

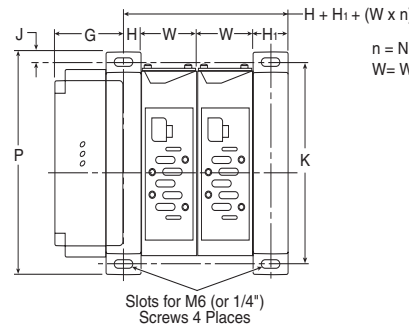

n = Number of H1 Bases
 W = Width of H1 Bases

H2
Dimensions

G	H	H₁	J	K
58	8.418	15	12	215
P	W			
239	56			

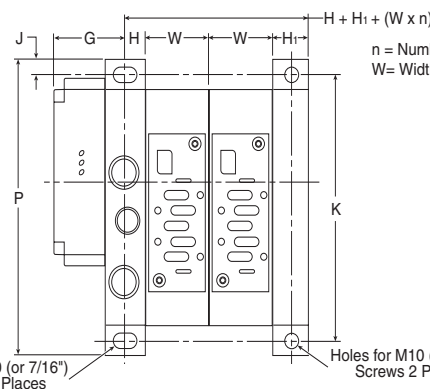

n = Number of H2 / H3 Bases
 W = Width of H2 / H3 Bases

H3
Dimensions

G	H	H₁	J	K
64	24	16.5	15	265
P	W			
295	71			

H1 5599-2 / 5599-1 Manifold

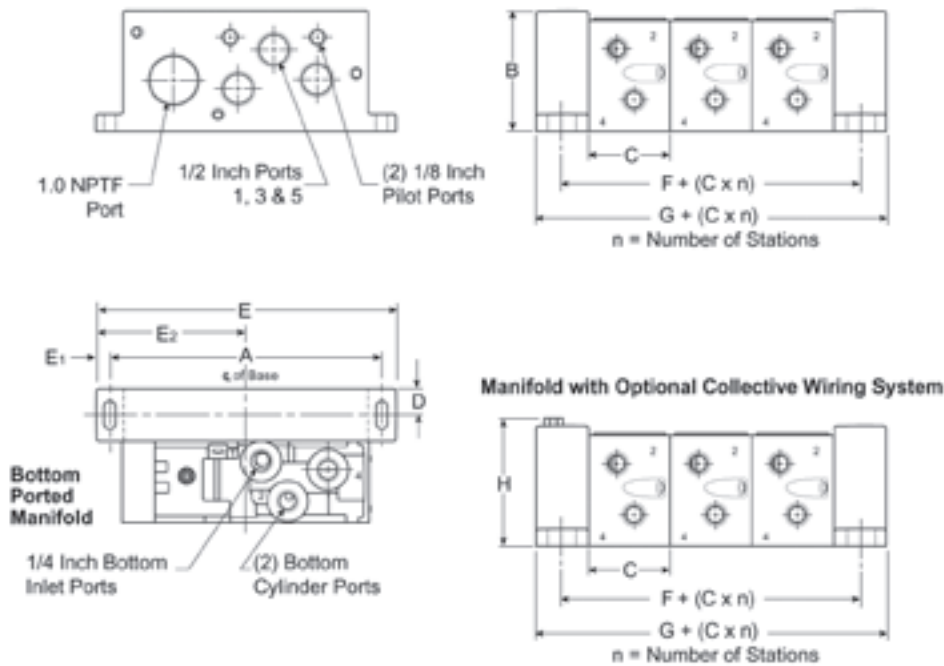

	A	B	C	D	E	E ₁	E ₂	F	G	H
H1	165	73	49	15.9	182	.84	91	31.8	63.5	76

H2 / H3 5599-2 / 5599-1 Manifold

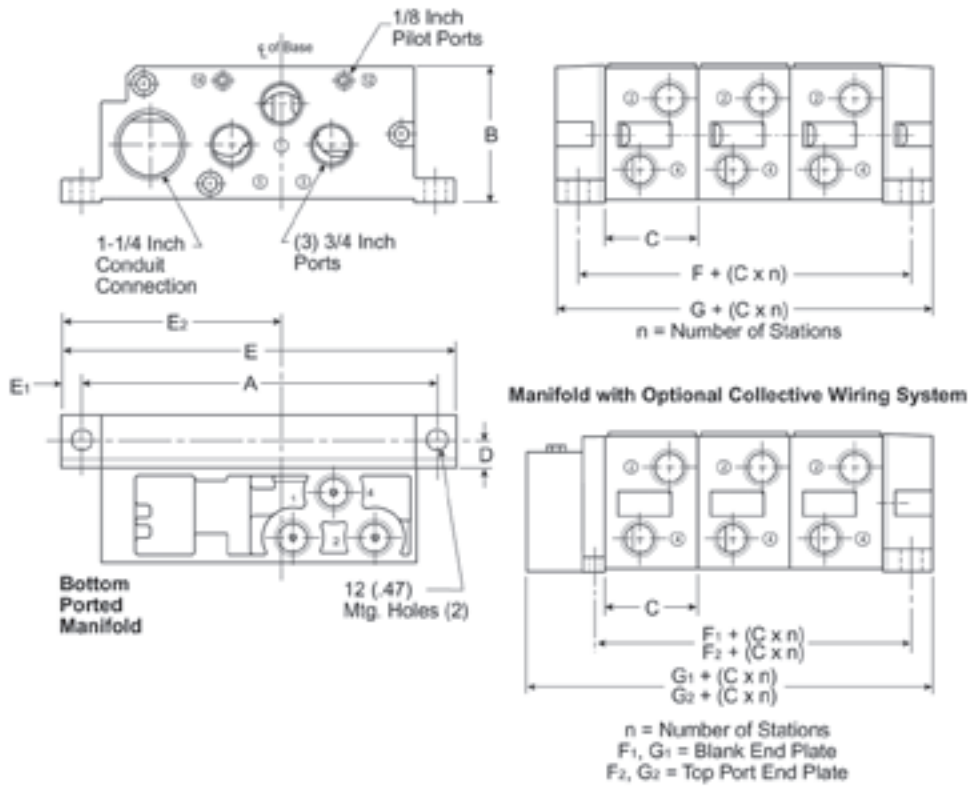

	A	B	C	D	E	E ₁	E ₂	F	F ₁	F ₂	G	G ₁ *	G ₂ *
H2	215	85	56	15	239	12	134	30	27	33	60	87	99

	A	B	C	D	E	E ₁	E ₂	F	F ₁	F ₂	G	G ₁ *	G ₂ *
H3	265	105	71	17	295	15	159	33	29	41	63	90	114

Interconnect Circuit Boards

Maximum Solenoids Energized Simultaneously

HA HB	Voltage code	25-pin D-Sub	19-pin round	Single 12-pin M23	Isysnet	
24 V DC	B9 / G9	24	16	8	32	
120 V AC*	23	24	16	8	32	
H1 H2 H3	Voltage code	25-pin D-Sub	19-pin round	Single 12-pin M23	Isysnet	SAM 3.0
12 V DC	45	13	13	8	N/A	N/A
24 V AC*	42	24	16	8	N/A	N/A
24 V DC	B9	20	16	8	21	4
120 V AC*	23	24	16	8	N/A	N/A

* Not CSA certified for 25-pin, D-Sub option.

19-Pin Round Brad Harrison

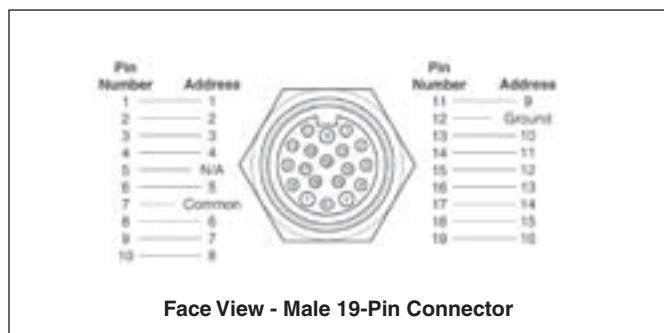

19-Pin Round Cable Specifications

Common Pin "7" is rated for 8 amps. Cable common wire must be greater than total amperage of solenoids on Add-A-Fold assembly.

Example:- 8 station manifold, 16 solenoids,
 120VAC - 16 x .039 amps = .63 total amp rating.
 NEMA 4 rated with properly assembled NEMA 4 rated cable.

Brad Harrison #333030P80M050 16.40 ft. (Female to Male Cable)

Brad Harrison #333030P80M0100 32.80 ft. (Female to Male Cable)

M23, 12-Pin Round Connector (Male)

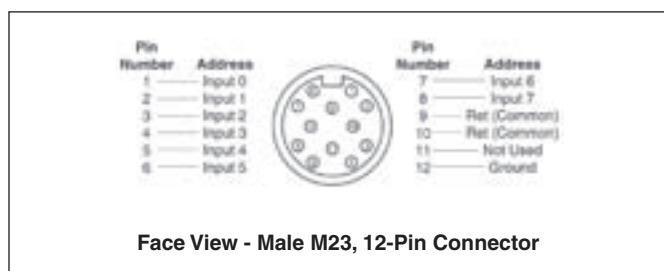

25-Pin, D-Sub Connector (Male)

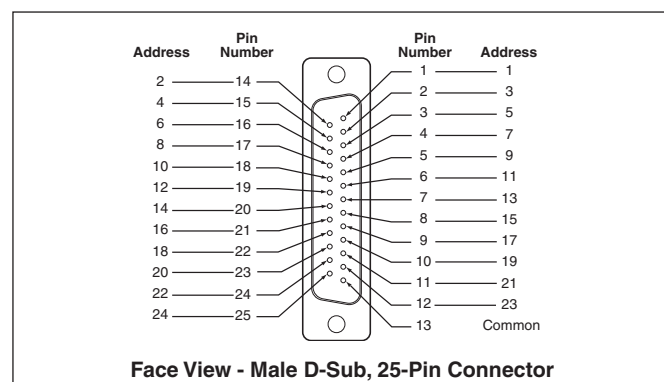

25-Pin, D-Sub Cable (Female)

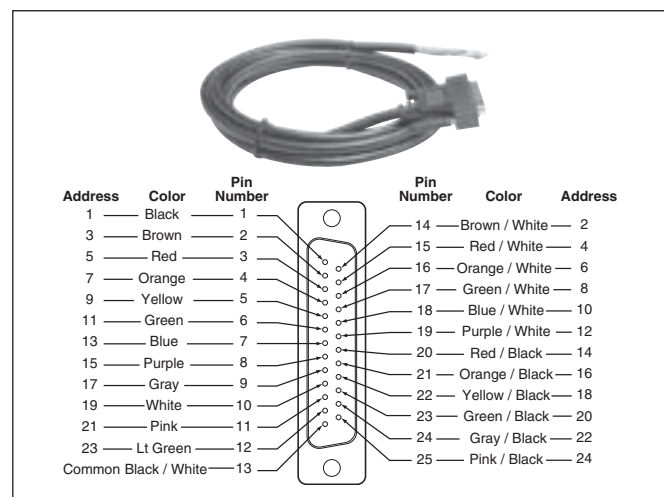

25-Pin, D-Sub Cable Specifications

Common Pin "13" is rated for 3 amps. Common wire rating must be greater than total amperage of all solenoids on a Add-A-Fold assembly.

IP65 rated with properly assembled IP65 rated cable.

M23, 12-Pin Round Connector (Female)

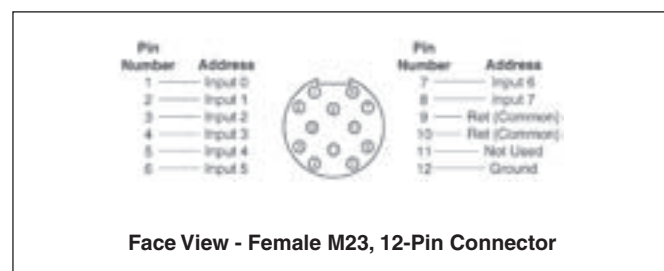

www.parker.com

Pneumatic Division Sales Offices

Austria - Wr.Neustadt

Tel: +43 2622 23501
Fax: +43 2622 66212

Belgium - Nivelles

Tel: +32 67 280 900
Fax: +32 67 280 999

**Czech & Slovak
Republics - Klecany**

Tel: +420 284 083 111
Fax: +420 2 4 083 112

Denmark - Ballerup

Tel: +45 43 560400
Fax: +45 43 733107

Finland - Vantaa

Tel: +358 9 4767 31
Fax: +358 9 4767 3200

France - Contamine

Tel : +33 4 50 25 80 25
Fax : +33 4 50 25 24 25

Germany - Kaarst

Tel: +49 2131 4016-0
Fax: +49 2131 4016-9199

Greece - Athens

Tel: +30 210 933 6450
Fax: +30 210 933 6451

Hungary - Budapest

Tel: +36 1 220 4155
Fax: +36 1 422 1525

Ireland - Dublin

Tel: +353 1 4666370
Fax: +353 1 4666376

Italy - Corsico, Milan

Tel: +39 02 4519 21
Fax: +39 02 4479 340

Netherlands - Oldenzaal

Tel: +31 541 585000
Fax: +31 541 585459

Norway - Langhus

Tel: +47 6491 1000
Fax: +47 6491 1090

Poland - Warsaw

Tel: +48 22 573 24 00
Fax: +48 22 573 24 03

**Portugal - Leça da
Palmeira**

Tel: +351 22 999 7360
Fax: +351 22 996 1527

Romania - Bucharest

Tel: +40 21 252 1382
Fax: +40 21 252 3381

Russia - Moscow

Tel: +7 095 580 91 45
Fax: +7 095 580 91 46

Slovenia - Novo mesto

Tel: +386 7337 6650
Fax: +386 7337 6651

Spain - Madrid

Tel: +34 91 675 7300
Fax: +34 91 675 7711

Sweden - Spånga

Tel: +46 8 5979 50 00
Fax: +46 8 5979 51 20

Switzerland - Bolligen

Tel.: +41 31 917 18 50
Fax: +41 31 917 18 59

Turkey - Istanbul

Tel: +90 212 482 91 06
Fax: +90 212 482 91 10

UK - Cannock

Tel: +44 1543 456000
Fax: +44 1543 456001

Ukraine - Kiev

Tel: + 380 44 494 2731
Fax: + 380 44 494 2730



Parker Hannifin Ltd.
Pneumatic Division,
Walkmill Lane, Bridgtown,
Cannock, Staffs. WS11 0LR
United Kingdom

We reserve the right to make
alterations without prior notification.

© Copyright 2007
Parker Hannifin Corporation
All rights reserved