



MICRO SWITCH™ Premium
Large Basic Switches
BZ | BA | BM | BE | 6AS Series



Datasheet

MICRO SWITCH™ Large Premium Basic Switches

Accurate, reliable, and repeatable, MICRO SWITCH™ BZ/BA/BM/BE Series features precise operating characteristics and enhanced life. These premium, large snap-action switches offer precision operation and sensitive differential travel.

Utilizing state-of-the-art manufacturing processes and quality controls, Honeywell has engineered premium, large snap-action switches that meet various international agency requirements. Some models have military qualifications. MICRO SWITCH™ BZ/BA/BM/BE Series are often used for precision on/off applications, as well as end of limit, presence/absence, and manual operator interface functions.

Their engineered design is suitable for various application needs. Configured options with BZ, BA, BM, and BE switches provide a wide variety of operating and interface characteristics.

The MICRO SWITCH™ 6AS Series consists of two large premium BZ/BA/BM/BE snap-action switches ganged together and actuated by a single actuator. Field adjustable operating point is an option for one or both switches.

What makes our switches better?

- Industry-leading temperature range for options up to 204 °C [400 °F] and temperatures as low as -55 °C [-67 °F]
- Exclusive current carrying capability of up to 25 A
- International approvals: UL, CSA, ENEC, CE listings
- Options for circuitry, styles, connection types and a wide selection of actuator styles
- Dependable performance - tested up to 20 million mechanical cycles
- MICRO SWITCH™ legacy and expertise - over 75 years of engineering excellence and experience



Operating in extreme temperatures is all in a day's work for MICRO SWITCH™ large basics!



QUALITY • RELIABLE • RUGGED • GLOBAL

Features and Benefits

GLOBAL USE AND APPROVALS

Switches certified to **UL, CSA, ENEC, and CE** for global use

FLEXIBILITY OF PRODUCT CHARACTERISTICS

Honeywell's large basic switches offer various operating force and differential travel options to meet the actuator type. Designed with **momentary or maintained contact action**, these switches may perform a variety of functions as well as offering a choice of actuation, termination and operating characteristics for **design flexibility**

Listings certified for global use and multiple applications

VARIANTS FOR EXTREME CONDITIONS

With an IP64 sealing option to maintain switch enclosure sealing, many listings can be used in dirty, harsh environments with their **dustproof and splash resistant seals**. Many versions operate in extreme temperatures, up to 121 °C [250 °F], and several with high temperature options for up to 204 °C [400 °F], as well as temperatures as low as -55 °C [-67 °F]

EASY INSTALLATION REDUCES OVERALL COSTS

The switch's elongated mounting hole allows for easier, more accurate mounting

TIGHT HYSTERESIS/DIFFERENTIAL TRAVEL

Designed with a hysteresis **as small as 0,008 mm [0.0003 in]**, the BZ/BA/BM/BE switches may be used in applications where very tight and sensitive control is required between the operate and release points

Standardize switching packages

CURRENT CAPACITY FROM LESS THAN 1 A TO 25 A

With a broad current capacity, **one switch package can control a wide range of electrical loads**. As requirements vary for applications, a standardized switch package may help reduce costs and increase application flexibility. **Gold contacts** available for controlling low energy/low power circuits

ENHANCED PERFORMANCE

Internal flat spring design delivers optimum **performance and switch reliability**

MILITARY APPROVALS

MIL-PRF-8805 switches available for military-specified applications

Potential Applications



BUILDING CONTROLS AND EQUIPMENT

Often used in a building's boiler/heater controls, in HVAC systems to sense exhaust pressure on high efficiency furnances, and in fire suppression systems to sound alarm when sprinkler activation/waterflow is detected. May also be used in machine tools to limit the maximum movement for pieces of equipment

DOORS AND LIFTS

May be used in elevators and lifts to sense if the car is in position before the door opens and on door-latching mechanisms to indicate door closed and/or door locked



SEMI-TRUCKS AND TRAILERS

Can be used to disengage the cruise control when the clutch pedal is depressed and for diesel engine brake assist. For surface transportation equipment, can be used as a seat switch

VALVES

Detects whether a valve is "open" or "closed"



TIMING DEVICES

Often used in commercial/industrial-grade timers to turn outputs "on" and/or "off" at preset times

COMMUNICATION SYSTEMS

May be used as a door interlock on communication consoles or enclosures

FOOT SWITCHES

In commercial and industrial foot switch enclosures, may be used as the switching element

COMMERCIAL AND INDUSTRIAL KITCHEN EQUIPMENT

May be used to indicate door closed and/or door locked for the self-cleaning feature

IRRIGATION EQUIPMENT

Often used for limiting maximum offset of irrigation towers

MEDICAL INSTRUMENTATION

In medical and dental equipment, often used in foot switches to control the dental drill and the positioning of the chair

MICRO SWITCH™ Premium Large Basic Switches

Table 1. Specifications

Characteristic	BZ Series	WZ Series	YZ Series	BA Series	WA Series	YA Series	BM Series	BE Series
								
Ampere rating	15 A			20 A			22 A	25 A
Circuitry	SPDT	SPNC	SPNO	SPDT	SPNC	SPNO	SPDT	SPDT
Operating force	1.0 oz to 28 oz							
Termination	quick connect, solder, screw							
Actuator	pin plunger, overtravel plunger, straight, roller, flexible leaf roller, flexible leaf							
Voltage	125 Vac, 250 Vac, 125 Vdc, 250 Vdc							
Agency approvals	UL, CSA, ENEC, CE (varies by specific model)							
Operating temperature	-55 °C to 85 °C [-67 °F to 185 °F]							
Contacts	silver, silver cadmium oxide, gold alloy							
Housing	general purpose phenolic							
Sealing	Environment sealing option available (options for IP64 Sealing)							
Dielectric strength	2000 V between each terminal and ground							
Contact resistance	15 m Ohm max.(initial)							
Insulation resistance	100 M Ohm min.							
Vibration	1,5 mm peak-to-peak amplitude, frequency 10 Hz to 55 Hz, for two continuous hours							
Expected mechanical life	up to 20,000,000 cycles at 95% survival							
Expected electrical service life	100K operations at rated load							
Rated frequency	50 Hz/60 Hz							

ELECTRICAL DATA AND UL CODES

Table 2. UL Electrical Ratings

Code	Circuitry	Electrical data and UL codes
A	SPDT	15 A, 125, 250 or 480 Vac; 1/8 HP, 125 Vac; 1/4 HP, 250 Vac; 1/2 A, 125 Vdc; 1/4 amp, 250 Vdc. UL Code L96
B	SPDT	5 A, 125, 250 or 480 Vac; 1/2 A, 125 Vdc; 1/4 amp, 250 Vdc. UL Code L35
C	SPDT	10 A, 125, 250 or 480 Vac; UL Code L8
D	SPDT	15 A, 125, 250 or 480 Vac; 1/8 HP, 125 Vac; 1/4 HP, 250 Vac. UL Code L103
E	SPDT	15 A, 125, 250 or 480 Vac; 1/4 HP, 125 Vac, 1/2 HP, 250 Vac; 1/2 A, 125 Vdc; 1/4 amp, 250 Vdc. UL Code L67
F	SPDT	22 A, 125, 250 or 480 Vac; 1/2 HP, 125 Vac, 1 HP, 250 Vac. UL Code L161
G	SPDT	20 A, 125, 250 or 480 Vac; 10 A, 125 Vac "L" (tungsten lamp load); 1 HP, 125 Vac; 2 HP, 250 Vac; 1/2 A, 125 Vdc; 1/4 A, 250 Vdc. UL Code L23
H	SPDT	Motor control - 25 A, 125, 250 or 480 Vac; 1 HP, 125 Vac; 2 HP, 250 Vac; Pilot duty—750 VA, 125, 250, or 277 Vac
I	SPDT	10 A, 125, 250 or 480 Vac; 1/8 HP, 125 Vac; 1/4 HP, 250 Vac; UL Code L95
P	SPDT	1 A, 125 Vac UL Code L22
T	Two-circuit, double break	Motor Control 15 A, 120, 240, 480 or 600 Vac; 1/2 HP, 120 Vac; 1 HP, 240 Vac; 0.8 amp, 115 Vdc; 0.4 amp, 230 Vdc.
W	SPST	20 A, 125, 250 or 277 Vac; 3/4 HP, 125 Vac; 1/2 HP, 250 Vac UL Code L178B
X	SPDT	15 A, 125, 250 or 480 Vac; 2 A, 600 Vac; 1/8 HP, 125 Vac; 1/4 HP, 250 Vac; 1/2 amp, 125 Vdc; 1/4 amp, 250 Vdc. UL Code L74

GENERAL SWITCH IDENTIFICATION

The first letter in the catalog listing designates:

- B** = Single pole, double throw
- W** = Single pole, normally closed
- Y** = Single pole, normally open

The second letter in the catalog listing designates:

- Z** = Standard, 15 A version
- M** = 22 A version
- A** = Standard, 20 A version
- E** = 25 A version

MOUNTING DIMENSIONS

Mounting dimensions are included in this datasheet. They are shown in English and metric equivalents. These dimensions are for reference only. Engineering drawings may be accessed via the Honeywell S&C web site: sensing.honeywell.com.

Mounting holes for Types BZ, BM, BA, BE, and 6AS switches accept pins or screws of 3,53 mm [0.139 in] diameter.

RECOMMENDED TORQUE

- Mounting screws 0,39 Nm [3 in-lb]*
- Terminal screws 0,45 Nm [4 in-lb]
- Panel mount bushing 0,45 Nm to 0,68 Nm [4 in-lb to 6 in-lb]

*Note: Tightening mounting screws above 0,3 Nm [3 in-lb] changes operating characteristics and increases the possibility of cracking the case.

UL/CSA

Honeywell basic switches are Component Recognized by Underwriters' Laboratories, Inc. and certified by Canadian Standards Association. The BA, BZ, and BM line is covered as Special Use Switches to UL Standard 1054; the BE line is covered as an Industrial Product to UL Standard 508. Agency File References are:

- BA UL File E12252, issued 12-09-88
- BM UL File E12252, issued 12-08-88
- BZ UL File E12252, issued 6-29-89
- BE-1,2,5 UL File E22779, Vol. 4, Sec. 1
- BE-R UL File E22779, Vol. 4, Sec. 2

MICRO SWITCH™ Premium Large Basic Switches

O.F. • Operating force
 R.F. • Release force
 P.T. • Pretravel
 O.T. • Overtravel
 D.T. • Differential travel
 O.P. • Operating position

ORDER GUIDE BY ASCENDING ELECTRICAL CAPABILITY

	Catalog Listing	Recommended For	Electrical Data and UL Codes	O.F. N [oz]	R.F. min. N [oz]	P.T. max. mm [in]	O.T. min. mm [in]	D.T. mm [in]	O.P.*** mm [in]
 BZ/BA type	BZ-2R72-A2**	Applications requiring gold alloy contacts	1 A P	2,5 to 3,61 [9 to 13]	1,11 [4]	0,38 [0.015]	0,13 [0.005]	0,01 to 0,05 [0.0004 to 0.0020]	15,88 [0.625]
	BZ-2R725551-A2	Gold alloy contacts Dustproof and splash resistant seal	1 A P	2,22 to 4,17 [8 to 15]	1,11 [4]	–	0,13 [0.005]	0,01 to 0,06 [0.0004 to 0.0025]	15,88 [0.625]
	BZ-2R244-A2	Operating in temp. to 204 °C [400 °F] for 100 hours	5 A B	2,5 to 3,61 [9 to 13]	1,11 [4]	0,38 [0.015]	0,13 [0.005]	0,01 to 0,05 [0.0004 to 0.0020]	15,88 [0.625]
	BZ-R21-A2	Lower force	10 A C	1,11 [4]	0,7 [2.5]	0,30 [0.012]	0,13 [0.005]	0,005 to 0,013 [0.0002 to 0.0005]	15,88 [0.625]
	BZ-2R-A2	Most applications SPDT	15 A A	2,5 to 3,61 [9 to 13]	1,11 [4]	0,38 [0.015]	0,13 [0.005]	0,01 to 0,05 [0.0004 to 0.0020]	15,88 [0.625]
	WZ-2R-A2	SPST (normally closed)	15 A A	2,5 to 3,61 [9 to 13]	1,11 [4]	0,38 [0.015]	0,13 [0.005]	0,01 to 0,05 [0.0004 to 0.0020]	15,88 [0.625]
	YZ-2R-A2	SPST (normally open)	15 A A	2,5 to 3,61 [9 to 13]	1,11 [4]	0,38 [0.015]	0,13 [0.005]	0,01 to 0,05 [0.0004 to 0.0020]	15,88 [0.625]
 Sealed type	BZ-R-A2	Less differential travel	15 A D	1,95 to 2,5 [7 to 9]	1,11 [4]	0,30 [0.012]	0,13 [0.005]	0,005 to 0,008 [0.0002 to 0.0003]	15,88 [0.625]
	BZ-R19-A2	Best repeatability	15 A D	1,95 to 3,34 [7 to 12]	1,11 [4]	0,30 [0.012]	0,13 to 0,2 [0.005 to 0.008]	0,005 to 0,02 [0.0002 to 0.0008]	16,26 [0.640]
	BZ-2R24-A2	Operating in temp. to 121 °C [250 °F]	15 A A	2,5 to 3,61 [9 to 13]	1,11 [4]	0,38 [0.015]	0,13 [0.005]	0,01 to 0,05 [0.0004 to 0.0020]	15,88 [0.625]
	BZ-2RT04 (M8805/1-004)	MIL-PRF-8805 application requirements	15 A A	2,5 to 3,61 [9 to 13]	1,67 [6]	0,38 [0.015]	0,13 [0.005]	0,01 to 0,05 [0.0004 to 0.0020]	15,88 [0.625]
	BZ-2R05-A2	Stability under varying humidity	15 A A	2,5 to 3,61 [9 to 13]	1,11 [4]	0,38 [0.015]	0,13 [0.005]	0,01 to 0,05 [0.0004 to 0.0020]	15,88 [0.625]
	BZ-2R5551-A2	Dustproof and splash resistant seal	15 A A	2,5 to 4,17 [9 to 15]	1,11 [4]	–	0,13 [0.005]	0,01 to 0,06 [0.0004 to 0.0025]	15,88 [0.625]
	BZ-2R55-A2-S	Sealed construction. Stainless steel internal snapspring	15 A A	2,5 to 4,17 [9 to 15]	1,11 [4]	–	0,13 [0.005]	0,01 to 0,06 [0.0004 to 0.0025]	15,88 [0.625]
 BA/BE type	BA-2R-A2	Up to 20 ampere load	20 A G	3,89 to 6,12 [14 to 22]	2,78 [10]	1,27 [0.050]	0,25 [0.10]	0,05 to 0,19 [0.0020 to 0.0075]	16,26 [0.640]
	BA-2R24-A2	Operating in temp. to 121 °C [250 °F]	20 A G	3,89 to 6,12 [14 to 22]	2,78 [10]	1,27 [0.050]	0,25 [0.10]	0,05 to 0,19 [0.0020 to 0.0075]	16,26 [0.640]
	BM-1R-A2	Up to 22 ampere load	22 A F	1,95 to 2,78 [7 to 10]	1,11 [4]	0,38 [0.015]	0,13 [0.005]	0,013 to 0,025 [0.0005 to 0.0010]	15,88 [0.625]
	BE-2R-A4	Up to 25 ampere load, #8 screw terminals	25 A H	3,89 to 6,12 [14 to 22]	2,78 [10]	1,27 [0.050]	0,25 [0.10]	0,05 to 0,19 [0.0020 to 0.0075]	16,26 [0.640]
 Manual Reset	BZ-RX	Manual reset, solder terminals	15 A E	1,95 to 2,5 [7 to 9] 0,56 to 2,78* [2 to 10]	–	0,30 [0.012] –	0,13 [0.005] 0,38* 0.015]	–	15,88 [0.625]
	WA-1RX-A4	Manual reset SPST-NC, #8 screw terminals	20 A W	5,56 [20] 6,95 [25]*	–	–	0,25 [0.010] –	0,20 [0.008] –	16,26 [0.64] 27,9*[1.10]

* Reset characteristics

** -A2 is supplied with #6 terminal screws

*** Except where stated, ±0,38 mm [±0.015 in]

O.F. • Operating force
 R.F. • Release force
 P.T. • Pretravel
 O.T. • Overtravel
 D.T. • Differential travel
 O.P. • Operating position

OVERTRAVEL PLUNGER ORDER GUIDE

	Catalog Listing	Recommended For	Electrical Data and UL Codes	O.F. N [oz]	R.F. min. N [oz]	P.T. max. mm [in]	O.T. min. mm [in]	D.T. mm [in]	O.P.* mm [in]
	BZ-2RD72-A2	Applications requiring gold alloy contacts	1 A P	2,5 to 3,61 [9 to 13]	1,11 [4]	0,38 [0.015]	1,52 [0.060]	0,01 to 0,05 [0.0004 to 0.0020]	21,21 [0.835]
	BZ-2RD-A2	Added overtravel. For manual operation and slow 20° (max) cam rise	15 A A	2,5 to 3,61 [9 to 13]	1,11 [4]	0,38 [0.015]	1,52 [0.060]	0,01 to 0,05 [0.0004 to 0.0020]	21,21 [0.835]
	BZ-2RD24-A2	Operating in temperature to 121 °C [250 °F]	15 A A	2,5 to 3,61 [9 to 13]	1,11 [4]	0,38 [0.015]	1,52 [0.060]	0,01 to 0,05 [0.0004 to 0.0020]	21,21 [0.835]
	BM-1RD-A2	Up to 22 ampere load	22 A F	1,95 to 2,78 [7 to 10]	1,11 [4]	0,38 [0.015]	1,52 [0.060]	0,013 to 0,025 [0.0005 to 0.0010]	21,21 [0.835]
	BZ-2RDS725551-A2	Applications requiring gold alloy contacts plus dustproof and splash resistant seal	1 A P	3,61 to 5,28 [13 to 19]	1,11 [4]	-	1,52 [0.060]	0,01 to 0,063 [0.0004 to 0.0025]	28,20 [1.110]
	BZ-2RDS5551-A2	Dustproof and splash resistant seal	15 A A	3,61 to 5,28 [13 to 19]	1,11 [4]	-	1,52 [0.060]	0,01 to 0,063 [0.0004 to 0.0025]	28,20 [1.110]
	BA-2RB-A2	Up to 20 ampere load	20 A G	3,89 to 6,12 [14 to 22]	2,78 [10]	1,27 [0.050]	2,39 [0.094]	0,05 to 0,019 [0.0020 to 0.0075]	26,20 [1.03]
	BE-2RB-A4	Up to 25 ampere load, #8 screw terminals	25 A H	3,89 to 6,12 [14 to 22]	2,78 [10]	1,27 [0.050]	2,39 [0.094]	0,05 to 0,019 [0.0020 to 0.0075]	26,20 [1.03]
	BZ-2RS72-A2	Applications requiring gold alloy contacts	1 A P	2,5 to 3,61 [9 to 13]	1,11 [4]	0,38 [0.015]	1,52 [0.060]	0,01 to 0,05 [0.0004 to 0.0020]	28,20 [1.110]
	BZ-2RS-A2	Added overtravel. For in-line operation and with JR aux. actuators	15 A A	2,5 to 3,61 [9 to 13]	1,11 [4]	0,38 [0.015]	1,52 [0.060]	0,01 to 0,063 [0.0004 to 0.0025]	28,20 [1.110]
	BZ-2RS24-A2	Operating in temperature to 121 °C [250 °F]	15 A A	2,5 to 3,61 [9 to 13]	1,11 [4]	0,38 [0.015]	1,52 [0.060]	0,01 to 0,05 [0.0004 to 0.0020]	28,20 [1.110]
	BZ-2RST04 (M8805/1-012)	MIL-PRF-8805 application requirements	15 A A	2,5 to 3,61 [9 to 13]	1,67 [6]	0,38 [0.015]	1,52 [0.060]	0,01 to 0,05 [0.0004 to 0.0020]	28,20 [1.110]
	BZ-RSX	Manual reset solder terminals	15 A E	1,95 to 2,64 [7 to 9]	-	0,30 [0.012]	0,65 [0.025]	-	2,79 [1.11]
	BM-1RS-A2	Up to 22 ampere load	22 A F	1,95 to 2,78 [7 to 10]	1,11 [4]	0,38 [0.015]	1,52 [0.060]	0,013 to 0,025 [0.0005 to 0.0010]	28,20 [1.110]
	BZ-2RS7225551-A2	Applications requiring gold alloy contacts plus dustproof and splash resistant seal	1 A P	2,5 to 4,17 [9 to 15]	1,11 [4]	-	1,52 [0.060]	0,01 to 0,063 [0.0004 to 0.0025]	28,20 [1.110]
	BZ-2RS5551-A2	Dustproof and splash resistant seal	15 A A	2,5 to 4,17 [9 to 15]	1,11 [4]	-	1,52 [0.060]	0,01 to 0,063 [0.0004 to 0.0025]	28,20 [1.110]

* ±51 mm [±0.020 in]

MICRO SWITCH™ Premium Large Basic Switches

O.F. • Operating force
 R.F. • Release force
 P.T. • Pretravel
 O.T. • Overtravel
 D.T. • Differential travel
 O.P. • Operating position

OVERTRAVEL PLUNGER ORDER GUIDE



	Catalog Listing	Recommended For	Electrical Data and UL Codes	O.F. N [oz]	R.F. min. N [oz]	P.T. max. mm [in]	O.T. min. mm [in]	D.T. mm [in]	O.P.** mm [in]
	BZ-2RQ-A2	Added overtravel. For manual in-line operation and for slow 30° (max) rise cams	15 A A	2,5 to 3,61 [9 to 13]	1,11 [4]	0,38 [0.015]	5,56 [0.219]	0,01 to 0,05 [0.0004 to 0.0020]	38,10 ±0,51 [1.50 ±0.02]
	BZ-2RQ24-A2	Operating in temperature to 121 °C [250 °F]	15 A A	2,5 to 3,61 [9 to 13]	1,11 [4]	0,38 [0.015]	5,56 [0.219]	0,01 to 0,05 [0.0004 to 0.0020]	38,10 ±0,51 [1.50 ±0.02]
	BZ-2RQ172-A2	Applications requiring gold alloy contacts	1 A P	2,5 to 3,61 [9 to 13]	1,11 [4]	0,38 [0.015]	5,56 [0.219]	0,01 to 0,05 [0.0004 to 0.0020]	21,82 [0.859]
	BZ-2RQ1-A2	BZ-2RQ-A2 type applications with panel mount	15 A A	2,5 to 3,61 [9 to 13]	1,11 [4]	0,38 [0.015]	5,56 [0.219]	0,01 to 0,05 [0.0004 to 0.0020]	21,82 [0.859]
	BZ-2RQ1T04 (M8805/1-020)	MIL-PRF-8805 application requirements	15 A A	2,5 to 3,61 [9 to 13]	1,67 [6]	0,38 [0.015]	5,56 [0.219]	0,01 to 0,05 [0.0004 to 0.0020]	21,82 [0.859]
	BZ-2RQ124-A2	Operating in temperature to 121 °C [250 °F]	15 A A	2,5 to 3,61 [9 to 13]	1,11 [4]	0,38 [0.015]	5,56 [0.219]	0,01 to 0,05 [0.0004 to 0.0020]	21,82 [0.859]
	BZ-2RN702	Furnished with unassembled seal boot.	15 A X	2,5 to 3,61 [9 to 13]	1,11 [4]	0,38 [0.015]	3,18 [0.125]	0,01 to 0,05 [0.0004 to 0.0020]	48,4 ±0,50 1.906 [±0.02]
	BZ-RQ1X	Manual reset. Solder terminals	15 A E	1,67 to 2,64 [6 to 9.5]	–	0,30 [0.012]	5,56 [0.219]	–	23,42 ±1,14 [0.922 ±0.045] 7,14* [0.281*]
	BA-2RQ1-A2	Up to 20 ampere load	20 A G	3,89 to 6,12 [14 to 22]	2,78 [10]	1,27 [0.050]	5,56 [0.219]	0,05 to 0,19 [0.0020 to 0.0075]	21,82 [0.859]
	BM-1RQ1-A2	Up to 22 ampere load	22 A F	1,95 to 2,78 [7 to 10]	1,11 [4]	0,38 [0.015]	5,56 [0.219]	0,013 to 0,025 [0.0005 to 0.0010]	21,82 [0.859]
	BZ-2RQ1872-A2	Applications requiring gold alloy contacts	1 A P	2,5 to 3,61 [9 to 13]	1,11 [4]	0,38 [0.015]	3,56 [0.140]	0,01 to 0,05 [0.0004 to 0.0020]	33,32 ±1,14 [1.31 ±0.045]
	BZ-2RQ18-A2	Added overtravel. Roller plunger for rapid cam (30° max) rise and slide operation. Panel mount	15 A A	2,5 to 3,61 [9 to 13]	1,11 [4]	0,38 [0.015]	3,56 [0.140]	0,01 to 0,05 [0.0004 to 0.0020]	33,32 ±1,14 [1.31 ±0.045]
	BZ-2RQ1824-A2	Operating in temperature to 121 °C [250 °F]	15 A A	2,5 to 3,61 [9 to 13]	1,11 [4]	0,38 [0.015]	3,56 [0.140]	0,01 to 0,05 [0.0004 to 0.0020]	33,32 ±1,14 [1.31 ±0.045]
	BZ-2AQ18T1	Double-break circuitry	15 A T	3,89 to 6,68 [14 to 24]	1,11 [4]	0,69 [0.025]	3,58 [0.141]	0,03 to 0,10 [0.001 to 0.004]	33,35 ±1,19 [1.31 ±0.047]
	BM-1RQ18-A2	Up to 22 ampere load	22 A F	1,95 to 2,78 [7 to 10]	1,11 [4]	0,38 [0.015]	3,56 [0.140]	0,013 to 0,025 [0.0005 to 0.0010]	33,32 ±1,14 [1.31 ±0.045]
	BZ-2RQ181-A2	Applications requiring roller plunger 90° to major axis of switch	15 A A	2,5 to 3,61 [9 to 13]	1,11 [4]	0,38 [0.015]	3,56 [0.140]	0,01 to 0,05 [0.0004 to 0.0020]	33,32 ±1,14 [1.31 ±0.045]

* Reset characteristics

** Except where stated, ±0,76 mm [±0.030 in]

O.F. • Operating force
 R.F. • Release force
 P.T. • Pretravel
 O.T. • Overtravel
 D.T. • Differential travel
 O.P. • Operating position

STRAIGHT LEVER ORDER GUIDE

	Catalog Listing	Recommended For	Electrical Data and UL Codes	O.F. N [oz]	R.F. min. N [oz]	P.T. max. mm [in]	O.T. min. mm [in]	D.T. mm [in]	O.P.** mm [in]
	BZ-2RW8072-A2	Applications requiring gold alloy contacts	1 A P	0,7 [2.5]	0,14 [0.5]	–	5,56 [0.219]	0,18 to 1,27 [0.007 to 0.050]	19,1 [0.750]
	BZ-2RW80722555105-A2	Stability under varying humidity. Gold alloy contacts with seal	1 A P	0,7 [2.5]	0,14 [0.5]	–	5,56 [0.219]	0,18 to 1,27 [0.007 to 0.050]	19,1 [0.750]
	BZ-2RW8244-A2	Operating in temp. to 204 °C [400 °F] for 100 hours	5 A B	0,7 [2.5]	0,14 [0.5]	–	5,56 [0.219]	0,18 to 1,27 [0.007 to 0.050]	19,1 [0.750]
	BZ-RW8435-A2	Lowest operating force (without external return spring)	10 A I	0,07 [0.25]	–	6,76 [0.266]	5,56 [0.219]	0,08 to 0,38 [0.003 to 0.015]	19,1 [0.750]
	BZ-2RW876T	1.25-inch lever	15 A A	1,67 [6]	0,42 [1.5]	–	0,42 [0.141]	0,10 to 0,63 [0.004 to 0.025]	19,1 [0.750]
	BZ-2RW80-A2	2.5-inch lever	15 A A	0,7 [2.5]	0,14 [0.5]	–	5,56 [0.219]	0,18 to 1,27 [0.007 to 0.050]	19,1 [0.750]
	BZ-2RW84-A2	Lower force (without external return spring)	15 A A	0,28 [1]	0,03 [0.125]	8,33 [0.328]	5,56 [0.219]	0,18 to 1,27 [0.007 to 0.050]	19,1 [0.750]
	BZ-2RW805551-A2	Dustproof and splash resistant seal	15 A A	0,7 [2.5]	0,14 [0.5]	–	5,56 [0.219]	0,18 to 1,27 [0.007 to 0.050]	19,1 [0.750]
	BZ-2RWT04 (M8805/1-044)	MIL-PRF-8805 application requirements	15 A A	0,28 to 0,90 [1 to 3.25]	0,21 [0.75]	7,52 [0.296]	4,37 [0.172]	2,36 [0.093]	19,1 [0.750]
	BZ-2RW824-A2	Operating in temperature to 121 °C [250 °F]	15 A A	0,7 [2.5]	0,14 [0.5]	–	5,56 [0.219]	0,18 to 1,27 [0.007 to 0.050]	19,1 [0.750]
	BZ-RW80X	Manual reset, solder terminals	15 A E	0,63 [2.25]	–	–	5,56 [0.219] 0,38* [0.015]	–	19,05 [0.750] 7,14* [0.281]
	BZ-2RW863-A2	6-inch lever	15 A A	0,28 [1]	–	–	12,7 [0.50]	0,46 to 3,68 [0.018 to 0.145]	19,1 ±1,52 [0.75 ±0.06]
	BA-2RV-A2	Up to 20 ampere load	20 A G	0,7 [2.5]	0,14 [0.5]	15,88 [0.625]	1,98 [0.078]	2,77 max. [0.109] max.	19,1 [0.750]
	BM-1RW84-A2	Up to 22 ampere load	22 A F	0,28 [1]	0,03 [0.125]	7,54 [0.297]	5,56 [0.219]	0,13 to 0,84 [0.005 to 0.033]	19,1 [0.750]
	BE-2RV-A4	Up to 25 ampere load #8 screw terminals	25 A H	0,7 [2.5]	0,14 [0.5]	15,88 [0.625]	1,98 [0.078]	2,77 max. [0.109] max.	19,1 [0.750]
	BZ-2RW899-A2	Adjustable operating point 17 mm to 22 mm [0.67 in to 0.88 in]	15 A A	0,7 [2.5]	0,14 [0.5]	–	3,54*** [0.125]	0,18 to 1,27 [0.007 to 0.050]	17,02 to 22,35 [0.670 to 0.880]
	BZ-2RM-A2	Reverse acting actuator (switch plunger depressed in free position)	15 A A	1,67 [6]	0,28 [1]	5,56 [0.219]	5,56 [0.219]	0,10 to 0,89 [0.004 to 0.035]	19,1 [0.750]

* Reset characteristics



** except where stated ±0,76 mm [±0.030 in]

*** from 17 mm [0.670 in] O.P.

MICRO SWITCH™ Premium Large Basic Switches

O.F. • Operating force
 R.F. • Release force
 P.T. • Pretravel
 O.T. • Overtravel
 D.T. • Differential travel
 O.P. • Operating position



SIMULATED ROLLER AND ROLLER LEVER ORDER GUIDE

	Catalog Listing	Recommended For	Electrical Data and UL Codes	O.F. N [oz]	R.F. min. N [oz]	P.T. max. mm [in]	O.T. min. mm [in]	D.T. mm [in]	O.P.** mm [in]
	BZ-2RW80147-A2	1.05 inch (26,7 mm) (simulated roller) lever applications	15 A A	1,67 [6]	0,42 [1.5]	–	2,39 [0.094]	0,08 to 0,51 [0.003 to 0.020]	30,17 [1.188]
	BZ-2RW80196-A2	1.90 inch (48,3 mm) (simulated roller) lever applications	15 A A	0,97 [3.5]	0,21 [0.75]	–	3,96 [0.156]	0,10 to 1,0 [0.004 to 0.040]	30,17 ±0,76 [1.188 ±0.03]
	BZ-2RW82272-A2	Applications requiring gold alloy contacts	1 A P	1,67 [6]	0,42 [1.5]	–	2,39 [0.094]	0,08 to 0,51 [0.003 to 0.020]	30,17 [1.188]
	BZ-2RW822725551-A2	Apps requiring gold alloy contacts plus dustproof and splash resistant seal	1 A P	1,67 [6]	0,42 [1.5]	–	2,39 [0.094]	0,08 to 0,51 [0.003 to 0.020]	30,17 [1.188]
	BZ-2RW822-A2	26,7 mm [1.05 in] mm) roller lever	15 A A	1,67 [6]	0,42 [1.5]	–	2,39 [0.094]	0,08 to 0,51 [0.003 to 0.020]	30,17 [1.188]
	BZ-2RW8222-A2	Roller turned 90°	15 A A	0,7 to 1,81 [2.5 to 6.5]	0,35 [1.25]	–	3,58 [0.141] max.	0,08 to 0,51 [0.003 to 0.020]	30,75 [1.25]
	BZ-2RW82224-A2	Operating in temperature to 121 °C [250 °F]	15 A A	1,67 [6]	0,42 [1.5]	–	2,39 [0.094]	0,08 to 0,51 [0.003 to 0.020]	30,17 [1.188]
	BZ-2RW822551-A2	Dustproof and splash resistant seal	15 A A	1,67 [6]	0,42 [1.5]	–	2,39 [0.094]	0,08 to 0,51 [0.003 to 0.020]	30,17 [1.188]
	BZ-2RW82255-A2-S	Best service for sealed construction. Stainless steel internal snap spring.	15 A A	1,67 [6]	0,42 [1.5]	–	2,39 [0.094]	0,08 to 0,51 [0.003 to 0.020]	30,17 [1.188]
	BA-2RV22-A2	Up to 20 ampere load	20 G	1,67 [6]	0,42 [1.5]	6,35 [0.250]	0,76 [0.030]	1,14 [0.045] max.	29,77 [1.172]
	BM-1RW822-A2	Up to 22 ampere load	22 F	1,67 [6]	0,42 [1.5]	–	2,39 [0.094]	0,025 to 0,33 [0.001 to 0.013]	30,17 [1.188]
	BE-2RV22-A4	Up to 25 ampere load, #8 screw terminals	25 H	1,67 [6]	0,42 [1.5]	6,35 [0.250]	0,76 [0.030]	1,14 [0.045] max.	29,77 [1.172]
	BZ-2RW82299-A2	Adjustable operating point. Roller lever 1.05 inch (26,7 mm)	15 A A	1,67 [6]	0,42 [1.5]	–	1,02 [0.040]	0,08 to 0,51 [0.003 to 0.020]	29,77 to 30,56 [1.172 to 1.203]
	BZ-2RW8299-A2	Adjustable operating point. Roller lever 1.90 inch (48,3 mm)	15 A A	0,97 [3.5]	0,21 [0.75]	–	2,16 [0.085]	0,10 to 1,0 [0.004 to 0.040]	29,2 to 31,5 [1.150 to 1.24]

** except where stated ±0,38 mm [±0.015 in]

O.F. • Operating force
 R.F. • Release force
 P.T. • Pretravel
 O.T. • Overtravel
 D.T. • Differential travel
 O.P. • Operating position

ROLLER LEVER ORDER GUIDE

	Catalog Listing	Recommended For	Electrical Data and UL Codes	O.F. N [oz]	R.F. min. N [oz]	P.T. max. mm [in]	O.T. min. mm [in]	D.T. mm [in]	O.P.** mm [in]
	BZ-2RW82725551-A2	Applications requiring gold alloy contacts, plus dustproof, and splash resistant seal	1 A P	0,97 [3.5]	0,21 [0.75]	–	3,96 [0.156]	0,10 to 1,0 [0.004 to 0.040]	30,17 ±0,76 [1.188 ±0.030]
	BZ-2RW82-A2	1.90 inch (48,3 mm) (steel roller) lever applications	15 A A	0,97 [3.5]	0,21 [0.75]	–	3,96 [0.156]	0,10 to 1,0 [0.004 to 0.040]	30,17 ±0,76 [1.188 ±0.030]
	BZ-2RW825551-A2	Dustproof and splash resistant seal	15 A A	0,97 [3.5]	0,21 [0.75]	–	3,96 [0.156]	0,10 to 1,0 [0.004 to 0.040]	30,17 ±0,76 [1.188 ±0.030]
	BZ-2RW8224-A2	Operating in temperature to 121 °C [250 °F]	15 A A	0,97 [3.5]	0,21 [0.75]	–	3,96 [0.156]	0,10 to 1,0 [0.004 to 0.040]	30,17 ±0,76 [1.188 ±0.030]
	BA-2RV2-A2	Up to 20 ampere load	20 A G	0,97 [3.5]	0,14 [0.5]	11,89 [0.468]	1,52 [0.060]	2,16 [0.085]	30,17 ±0,76 [1.188 ±0.030]
	BM-1RW82-A2	Up to 22 ampere load	22 A F	0,97 [3.5]	0,21 [0.75]	–	3,96 [0.156]	0,08 to 0,56 [0.003 to 0.022]	30,17 ±0,76 [1.188 ±0.030]
	BE-2RV2-A4	Up to 25 ampere load, #8 screw terminals	25 A H	0,97 [3.5]	0,14 [0.5]	11,89 [0.468]	1,52 [0.060]	2,16 [0.085]	30,17 ±0,76 [1.188 ±0.030]
	BZ-RW922-A2	Best repeatability and O.P. stability	10 A I	3,34 [12]	1,11 [4]	0,35 [0.015]	2,54 [0.100]	0,013 to 0,025 [0.0005 to 0.0010]	31,37 [1.235]
	BZ-2RW826-A2	One-way roller 9,4 mm x 3,8 mm [0.37 in dia. x 0.15 in] wide roller	15 A A	1,67 [6]	0,42 [1.5]	–	2,39 [0.094]	0,08 to 0,51 [0.003 to 0.020]	41,34 [1.625]
	BZ-2RW825-A2	One-way roller 4,83 mm x 4,83 mm [0.19 in dia. x 0.19 in] wide roller	15 A A	2,22 [8]	0,42 [1.5]	–	1,52 [0.060]	0,38 [0.015]	28,96 [1.14]



NOTE: For adjustable operate point and simulated roller lever switches, refer to previous page.

** except where stated ±0,38 mm [±0.015 in]

MICRO SWITCH™ Premium Large Basic Switches

O.F. • Operating force
 R.F. • Release force
 P.T. • Pretravel
 O.T. • Overtravel
 D.T. • Differential travel
 O.P. • Operating position

FLEXIBLE LEAF AND FLEXIBLE ROLLER LEAF ORDER GUIDE

	Catalog Listing	Recommended For	Electrical Data and UL Codes	O.F. N [oz]	R.F. min. N [oz]	P.T. max. mm [in]	O.T. min. mm [in]	D.T. mm [in] max.	O.P.** mm [in]
	BZ-2RL-A2	Force and stability of the flexible leaf actuator	15 A A	1,39 [5]	0,14 [0.5]	–	1,52 [0.060]	1,27 [0.050]	17,48 [0.688]
	BZ-2RL5551-A2	Dustproof and splash resistant seal	15 A A	1,95 [7]	0,14 [0.5]	–	1,52 [0.060]	1,27 [0.050]	17,48 [0.688]
	BZ-2RLT04 (M8805/1-001)	MIL-PRF-8805 application requirements	15 A A	1,39 [5]	0,14 [0.5]	–	1,52 [0.060]	1,27 [0.050]	17,48 [0.688]
	BZ-2RL24-A2	Operating in temperature to 121 °C [250 °F]	15 A A	1,39 [5]	0,14 [0.5]	–	1,52 [0.060]	1,27 [0.050]	17,48 [0.688]
	BZ-RLX	Manual reset. Solder terminals	15 A E	0,83 [3]	–	–	1,57 [0.062] 0,38* [0.015]	–	17,48 [0.688] 7,14* [0.281]
	BA-2RL-A2	Up to 20 ampere load	20 A G	2,5 [9]	0,28 [1]	–	1,57 [0.062]	1,57 [0.062]	17,48 [0.688]
	BE-2RL-A4	Up to 25 ampere load, #8 screw terminals	25 A H	2,5 [9]	0,28 [1]	–	1,57 [0.062]	1,57 [0.062]	17,48 [0.688]
	BZ-RL24-A2	Operating in temp. to 121 °C [250 °F] for 100 hours	5 A B	1,39 [5]	0,14 [0.5]	–	1,52 [0.060]	1,27 [0.050]	28,6 [1.125]
	BZ-2RL2-A2	Force and stability of the flexible leaf with roller	15 A A	1,39 [5]	0,14 [0.5]	–	1,52 [0.060]	1,27 [0.050]	28,6 [1.125]
	BZ-2RL25551-A2	Dustproof and splash resistant seal	15 A A	1,95 [7]	0,14 [0.5]	–	1,52 [0.060]	1,27 [0.050]	28,6 [1.125]
	BZ-2RL2T04 (M8805/1-036)	MIL-PRF-8805 application requirements	15 A A	1,04 to 1,39 [3.75 to 5]	0,14 [0.5]	–	1,52 [0.060]	1,27 [0.050]	28,6 [1.125]
	BA-2RL2-A2	Up to 20 ampere load	20 A G	2,5 [9]	0,28 [1]	–	1,52 [0.060]	1,65 [0.065]	28,6 [1.125]
	BE-2RL2-A4	Up to 25 ampere load, #8 screw terminals	25 A H	2,5 [9]	0,28 [1]	–	1,52 [0.060]	1,65 [0.065]	28,6 [1.125]

NOTE: For adjustable operate point and simulated roller lever switches, refer to previous page.

** except where stated $\pm 0,76$ mm [± 0.030 in]

BZ | BA | BM | BE | 6AS Series

STANDARD ACTUATOR OPTIONS, TERMINALS, & DIMENSIONS

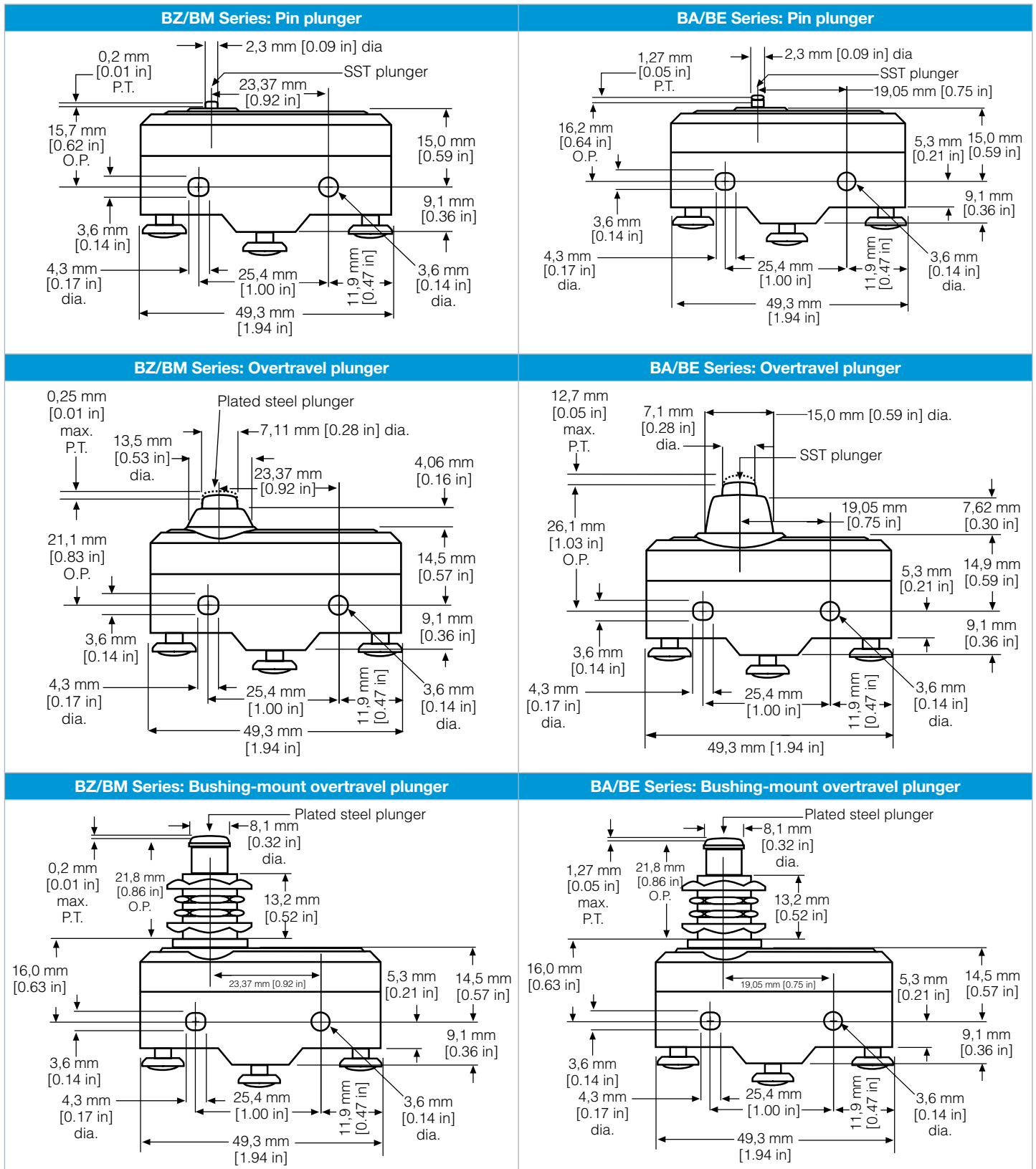

MICRO SWITCH™ Premium Large Basic Switches

STANDARD ACTUATOR OPTIONS, TERMINALS, & DIMENSIONS

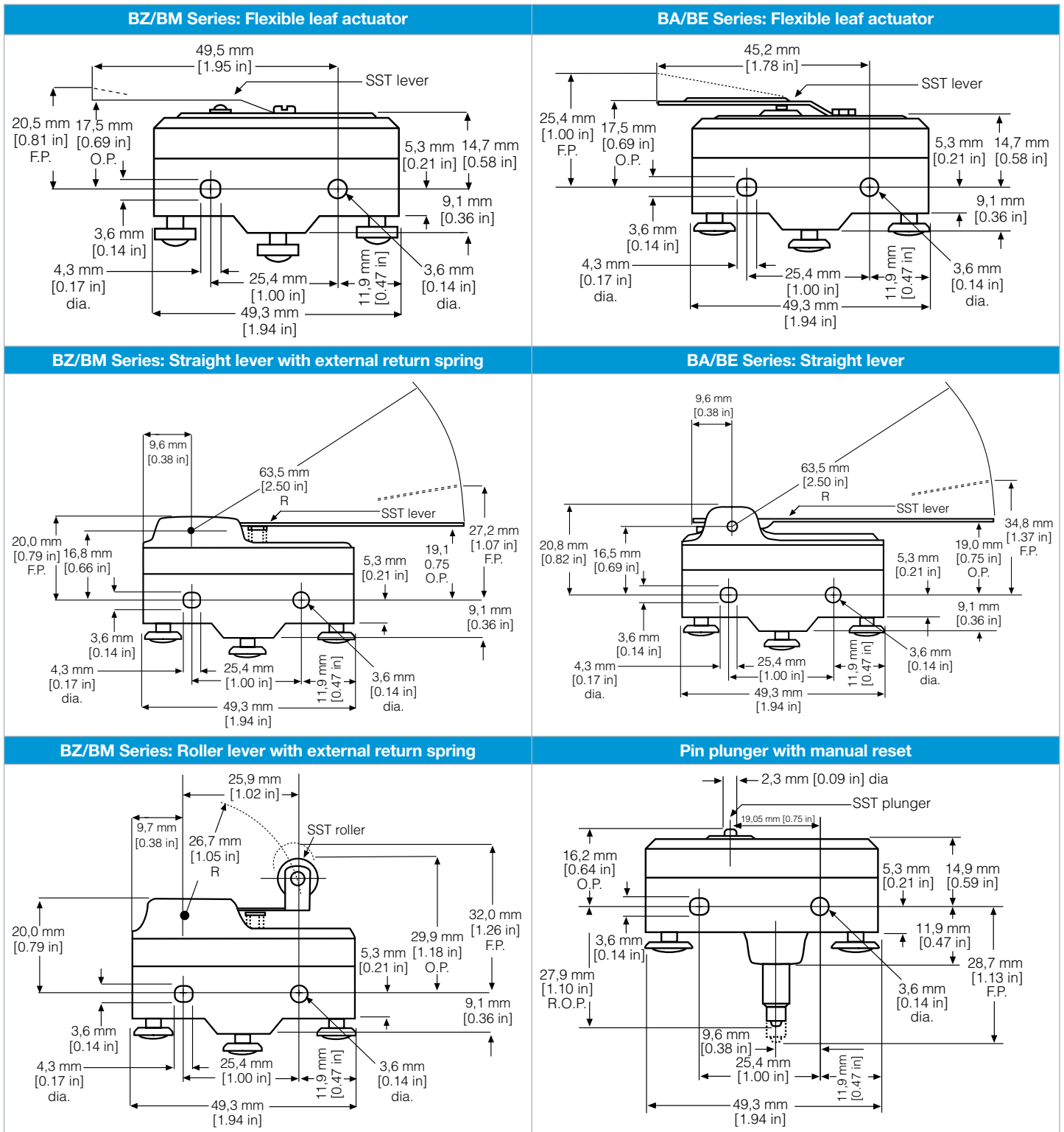

BZ | BA | BM | BE | 6AS Series

6AS SERIES - PREMIUM LARGE SNAP-ACTION TANDEM SWITCH ASSEMBLY



The MICRO SWITCH™ 6AS Series consists of two large premium BZ/BA/BM/BE snap-action switches ganged together and actuated by a single actuator. Operating characteristics are dependent upon the type of individual switches and actuators chosen. Field adjustable operating point on one or both basic switches. Solder, A2, and T-type terminations available, along with straight, roller, and leaf levers. Mounting holes accept pins or screws of 3,53 mm [0.139 in] diameter. Often used for boiler controls or anywhere two circuits need to be controlled by one actuator.

O.F. • Operating force
 R.F. • Release force
 O.T. • Overtravel
 D.T. • Differential travel
 O.P. • Operating position

6AS SERIES ORDER GUIDE

	Catalog Listing	Recommended For	Electrical Data and UL Codes	Lever length	Terminal type	O.F. N [oz]	R.F. min. N [oz]	O.T. min. mm [in]	D.T. mm [in]	O.P.* mm [in]
	6AS34	Centered lever. Adjustment over switch D	15 A A	30,56 mm [1.203 in]	A2	2,22 [8]	0,14 [0.5]	0,51 [0.020]	2,77 [0.109]	29,77 [1.172]
	6AS36	Lever over switch C. Adjustment over switch D	15 A A	30,56 mm [1.203 in]	A2	2,22 [8]	0,14 [0.5]	0,51 [0.020]	2,77 [0.109]	29,77 [1.172]
	6AS16	Centered lever. Adjustment over switch D	20 A G	30,56 mm [1.203 in]	A2	3,89 [14]	1,11 [4]	1,02 [0.040]	3,96 [0.156]	30,96 ±1,14 [1.219 ±0.045]
	6AS201	Lever over switch C. No adjustment. Sealed construction	15 A A	26,67 mm [1.05 in]	A2 and D6 6,35 mm x 0,81 mm [0.25 in x 0.32 in]	4,2 [15]	0,42 [1.5]	2,4 [0.094]	1,3 [0.050]	30,2 [1.188]
	6AS5	Centered leaf. No adjustment. Switches operate within 0.030 in of each other	15 A A	38,38 [1.51]	A2	-	-	0,76 to 1,52 [0.030 to 0.060]	-	-
	6AS28	Centered lever. Adjustment over switch C	20 A G	32,26 [1.27]	A2	3,89 [14]	1,11 [4]	1,02 [0.040]	-	18,67 [0.735]

* except where stated ±0,76 mm [±0.030 in]

MICRO SWITCH™ Premium Large Basic Switches

STANDARD ACTUATOR OPTIONS, TERMINALS, & DIMENSIONS

6AS Series: Straight Lever

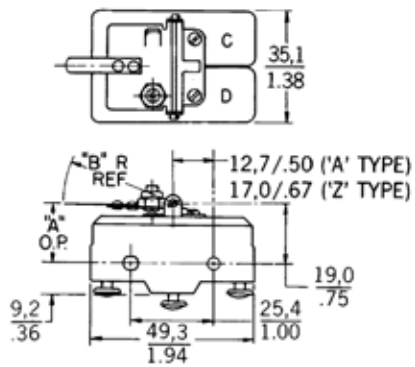

6AS Series: Leaf actuator

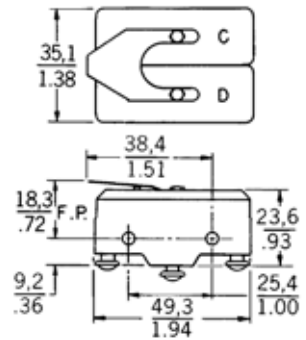

6AS Series: Roller Lever

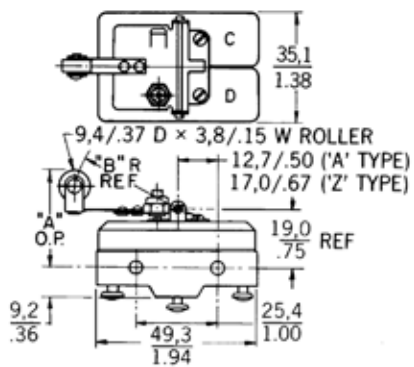

OPERATING CHARACTERISTICS

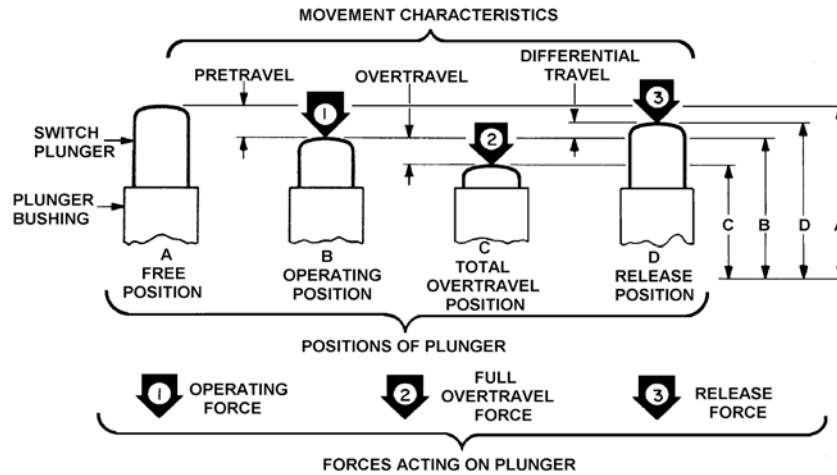
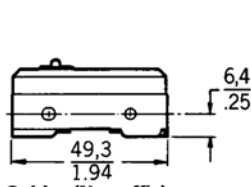

Table 3. Operating Characteristics Definitions

Characteristic	Description
Differential Travel-DT	Plunger or actuator travel from point where contacts “snap-over” to point where they “snap-back.”
Free Position-FP	Position of switch plunger or actuator when no external force is applied.
Full Overtravel Force	Force required to attain full overtravel of actuator.
Operating Position-OP	Position of switch plunger or actuator at which point contacts snap from normal to operated position. With flexible or adjustable actuators, the operating position is measured from the end of the lever or its maximum length. Location of operating position measurement shown on mounting dimension drawings.
Operating Force-OF	Amount of force applied to switch plunger or actuator to cause the contact “snap-over.” Note in the case of adjustable actuators, the force is measured from the maximum length position of the lever.
Overtravel-OT	Plunger or actuator travel safely available beyond operating position.
Pretravel-PT	Distance or angle traveled in moving plunger or actuator from free position to operating position.
Release Force-RF	Amount of force still applied to switch plunger or actuator at the moment contacts snap from operated position to non-operated position.
Total Travel	Distance from actuator free position to overtravel limit position.

MICRO SWITCH™ Premium Large Basic Switches

AVAILABLE TERMINALS



Solder (No suffix)
Use up to #14 wire

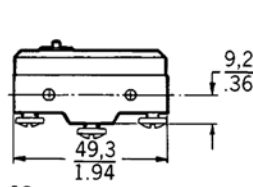

A2
Bottom facing 6-32 NC x .218" screw with cup washers

A4
(Same as A2 except #8 screws)

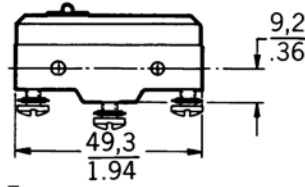

T
Bottom facing 6-32 NC x .218" screw with Sems lockwashers

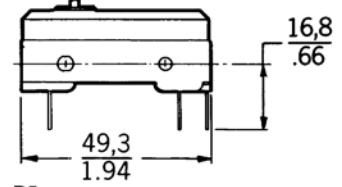

D5
.250" (6.35 mm) wide x .030" (7.62) thick quick-connect

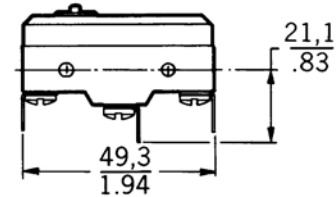

D6
.250" (6.35 mm) wide x .032" (0.81 mm) thick quick-connect

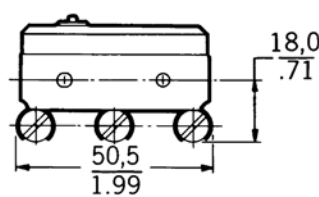

P4
Side facing 8-32 x .218" screw with cup washers

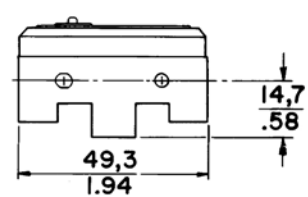

PC2
Self lifting pressure plate terminals and plastic barriers for added dielectric protection

ACTUATORS

BA, BE, BM, and BZ standard snap-action switches use the actuators described:

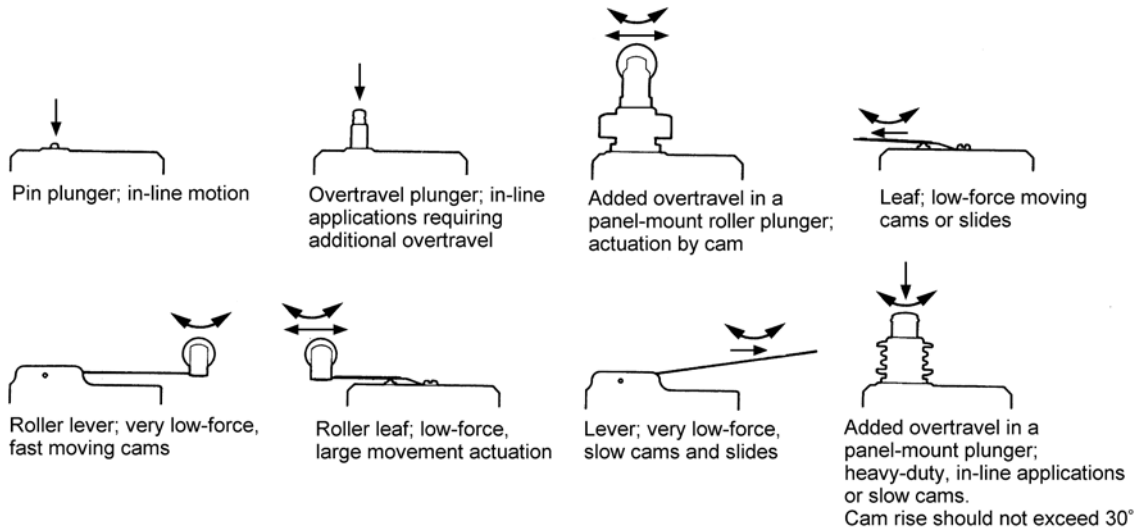

LARGE PREMIUM SWITCH SERIES NOMENCLATURE TREE (NOT ALL CONFIGURATIONS AVAILABLE)



B	Z	2	R	W	82255	A2	S
Type & Contact	Switch type	Break distance (nominal)	Construction	Integral actuator	Misc. Variations (Numbers or Letters)	Terminal type	Snap spring mat'l (variation)
B Series Premium Basics substitute W Series for SPNC circuitry	Z 15 A capacity**; pin plunger 23, 3 [0.917] from mounting hole	1 0.25 mm [0.01 in]	R Moving contact rivet construction	B Low overtravel plunger, Type A & E	0 Before or other number= military construction	A2 Bottom facing #6 screws & cupwashers	S Stainless steel snap spring
SPDT substitute Y Series for SPNO circuitry	A 20 A capacity**; pin plunger 19.0 [0.750] from mounting hole	2 0.50 mm [0.02 in]	A Shorting bar circuitry Type Z switches only	D Low overtravel plunger, Type Z	1 Threaded bushing, panel mount Q-plunger	A4 Bottom facing #8 screws & cupwashers	
	M 22 A capacity; pin plunger 23, 3 [0.917] from mounting hole	3 0.91 mm [0.036 in]	S Shorting bar circuitry Type A switches only	DS Sealed low overtravel plunger, Type Z only	2 Variation of design	A22 A2 type without screws & cupwashers	
	E 25 A capacity; pin plunger 19.0 [0.750] from mounting hole	4 1.14 mm [0.045 in] (MT-4R only)	G Make-before-break switches	L Leaf actuator Type A & Z only	4 On W-lever, light force var. (no spring)	A41 A4 type without screws & cupwashers	
		5 1.27 mm [0.050 in] Type A switches only	Y Split contact switches Type Z switches only	N High overtravel plunger/sealed boot	5 Used with other 5s, denotes sealed cons.	A46 A4 type #8 screws and lock washers	
		7 1.78 mm [0.07 in] Type Z switches only		Q High overtravel plunger, Type A & Z	6/7 On Q plunger, replac. for die-cast switches	D1 89° QC used with flat base w/o slots	
		- 0.15 mm [0.006 in]		S Medium overtravel plunger, Type Z only	7 Variation of design, other than Q plungers	D5 45° QC used with flat base	
				V Rigid lever Type A & E only	8 With W-levers, rigid type lever (ex. W80)	D6 90° QC used with flat base	
				W Rigid or resilient lever, Type Z only	8 With Q-plunger, roller plunger (inline to axis)	P1 (left) side facing #8 screw w/ cupwasher solder lug base	
				M Reverse actuating lever	9 With L-leaf actuators, flat leaf	P2 Same as P1, except facing right	
				QW Omnidirectional "wobble" lever	72 Gold contacts	P4 (left) side facing #8 screw w/ cupwasher integral construction	
				- Standard pin plunger	9 On Q-plunger, detach. roller, turned 90°	P5 Same as P4, except facing right	
					22 Short roller lever, V- or W-lever	T Bottom facing #6 screws/lockwashers	
					24 Heat resistant construction 121 °C	- Solder lug or no terminal hardware	
					55 Heavy-duty seal cons. Stain steel snap spring, Special inserts		
					81 On Q-plunger, roller 90° to major axis		
					82 Long W-lever, with roller		
					99 On W-lever, adj. O.P. (usually w/ 8)		
					244 High temp. constr. Diff snap spring Lower elect. rating		
					5551 General use sealed construction		
					882 Short W-lever with roller		
					X Maintained manual reset		

Notes
 * Min. distance between separated mating contacts in fully open position (nominal values).
 ** Some versions have lower electrical ratings.
 *** Except BZ-R31 and BZ-RZ switches.



MICRO SWITCH™ Premium Large Basic Switches

LARGE SNAP-ACTION SWITCH ACCESSORIES



Brackets

Description	8MA1	8MA2	17MA1-B
			
Description	Adjustable mounting bracket with adjustment slot on left	Adjustable mounting bracket with adjustment slot on right	Conversion mounting bracket
Housing material	Steel	Steel	Corrosion-resistant metal
Measurements	60,2 mm W x 21,3 mm H x 7,4 mm D [2.37 in W x 0.84 in H x 0.29 in D]		66,8 mm W x 19,0 mm D [2.63 in W x 0.75 in D]
Features	sturdy plated steel construction; fast, easy screwdriver adjustment; can be used with most standard basic switches		converts standard basic switches from side to top mount; corrosion resistant; snaps into switch mounting holes without tools

Die-cast Zinc Enclosures

Description	3PA1	3PA28	3PA2
			
Description	mounted from either side through 3,55 mm [0.140 in] dia. holes on 25,4 mm [1.0 in] centers; conduit/hub 0.5 – 14 NPT internal thread	mounted from either side through 3,55 mm [0.140 in] dia. holes on 25,4 mm [1.0 in] centers. 1/2-14 NPSM internal thread conduit hub	switch secured in enclosure; two 4,37 mm [0.172 in] dia. holes in flange accept #8 screws for mounting on 41,3 mm [1.625 in] centers; conduit/hub 0.5 – 14 NPT internal thread
Housing material	die-cast zinc enclosure (side mount)	die-cast zinc enclosure (side mount)	die-cast zinc enclosure (flange mount)
Measurements	74,8 mm W x 42,9 mm H x 25,4 mm D [2.95 in W x 1.69 in H x 1.00 in D]	74,8 mm W x 42,9 mm H x 25,4 mm D [2.95 in W x 1.69 in H x 1.00 in D]	74,8 mm W x 42,9 mm H x 25,4 mm D [2.95 in W x 1.69 in H x 1.00 in D]
Sealing/Features	NEMA 1; IP 40; protects the switch from physical abuse and personnel from contact with exposed terminals		

Plastic Thermal Enclosures

Description	5PA1	5PA2	5PA3
			
Description	Plastic terminal enclosure used with solder terminal switches	Plastic terminal enclosure use with screw terminal switches	Plastic terminal enclosure used with either solder or screw terminal switches with auxiliary actuators assembled
Housing material	plastic	plastic	plastic
Measurements	52,8 mm W x 16,1 mm H [2.08 in W x 0.64 in H]	52,8 mm W x 20,2 mm H x 21,0 mm D [2.08 in W x 0.80 in H x 0.83 in D]	52,8 mm W x 20,2 mm H x 21,0 mm D [2.08 in W x 0.80 in H x 0.83 in D]
Sealing/Features	NEMA 1, IP 40; easy to use; screw and solder terminal versions; protect personnel from contact with exposed terminals		

AUXILIARY ACTUATOR ORDER GUIDE

	Catalog Listing	Description	Use only with	Overtravel min. mm [in]	Operating Position* mm [in]	Free Position mm [in]
	JR	Roller lever for "S" plunger type BZ switches only. Permits cam operation	BZ	11,1 mm [0.437 in]	44,45 mm ±3,18 mm [1.75 in ±0.125 in]	-
	AD5721R (M8805/59) AN3169-1	Adjustable roller lever. Tang on top of actuator can be bent to adjust O.P. and F.P.	BZ, BM	11,1 mm [0.437 in] approx.	31,75 mm to 41,15 mm [1.25 in to 1.62 in]	39,6 mm to 43,7 mm [1.56 in to 1.72 in]
	ADA3721R		BA, BE	9,53 mm [0.375 in] approx.	40,48 mm [1.594 in] approx.	46,03 mm [1.812 in]
	MC2711 (M8805/59) AN3168-2	Straight plunger. Panel mount	BZ, BM	4,78 mm [0.188 in]	27,79 mm [1.094 in]	29,4 mm [1.156 in]
	MCA2711		BA, BE	3,96 mm [0.156 in]	28,17 mm [1.109 in]	30,18 mm [1.188 in]
	MC2711H	Sealed straight plunger. Panel mount. Elastomer boot seal resists liquid splash and dirt. Furnished unassembled.	BZ, BM	4,78 mm [0.188 in]	28,98 mm [1.141 in]	29,4 mm [1.156 in]
	MCA2711H		BA, BE	4,37 mm [0.172 in]	27,38 mm ±0,76 mm [1.078 in ±0.030 in]	29,56 mm [1.156 in]
	MD3211Q	Roller plunger. Panel mount. Roller parallel to long axis of the switch	BZ, BM	3,18 mm [0.125 in] approx.	35,7 mm [1.406 in]	37,69 mm [1.484 in]
	MDA3711Q		BA, BE	3,18 mm [0.125 in]	36,12 mm [1.422 in]	37,69 mm [1.484 in]
	MD3211Q1	Cross roller plunger. Panel mount. Roller perpendicular to long axis of the switch	BZ, BM	3,18 mm [0.125 in] approx.	35,7 mm [1.406 in]	37,69 mm [1.484 in]
	MDA3711Q1		BA, BE	3,18 mm [0.125 in]	36,12 mm [1.422 in]	37,69 mm [1.484 in]
	MC7711 (M8805/58) AN3167-1	High overtravel plunger. Panel mount	BZ, BM	20,62 mm [0.812 in]	69,1 mm [2.719 in]	70,64 mm [2.781 in]
	MCA7711		BA, BE	19,84 mm [0.781 in]	69,44 mm [2.734 in]	71,42 mm [2.812 in]

* except where stated ±1,14 mm [±0.045 in]

NOTE: All actuators are for use with pin plunger types only, except catalog listing JR.

MICRO SWITCH™ Premium Large Basic Switches

This Honeywell datasheet supports the following MICRO SWITCH™ Premium Large Basic Switch Listings

6AS16	BA-2RV312T	BM-1RD33-A2	BZ-2R296	BZ-2RL	BZ-2RQ181M-A2RS
6AS201	BA-2RV314-A22	BM-1RD373	BZ-2R3000-T4-J	BZ-2RL131T	BZ-2RQ181T
6AS25	BA-2RV32-P405	BM-1R-P5	BZ-2R331	BZ-2RL2	BZ-2RQ1824-A2
6AS34	BA-2RV336-A2	BM-1RQ18124-A2	BZ-2R352420-A2	BZ-2RL204	BZ-2RQ1872-A2
6AS36	BA-2RV338	BM-1RQ18-A2	BZ-2R383-A2	BZ-2RL224	BZ-2RQ18-A2
6AS5	BA-2RV339-A2	BM-1RQ1-A2	BZ-2R389-A2	BZ-2RL2-A2	BZ-2RQ18-D5
6ASN13	BA-2RV45-A2	BM-1RS-A2	BZ-2R391-A2	BZ-2RL2T04	BZ-2RQ18M
6ASN39	BA-2RV6-A2	BM-1RW822-A2	BZ-2R53-A2	BZ-2RL5551-A2	BZ-2RQ18MA2
8AS244-MT	BA-2RV-A2	BM-1RW82-A2	BZ-2R55	BZ-2RL5551T	BZ-2RQ18M-A2
8AS252-BZ	BA-2RV-A4	BM-1RW84225551051-A2	BZ-2R55156T-S	BZ-2RL55T-S	BZ-2RQ18M-A2RS
8AS254-BZ	BA-2RV-D5	BM-1RW842255511-A2	BZ-2R5528-S	BZ-2RL711	BZ-2RQ18MD611
8AS264-MT	BA-2RV-P4	BM-1RW842255511-A2	BZ-2R55513-A2	BZ-2RL712	BZ-2RQ18-P4
BA-1R2416-A42	BA-2RVT	BM-1RW84464-A4	BZ-2R5551-A2	BZ-2RL99	BZ-2RQ18T
BA-1R3511	BA-2SBT	BM-2R559729	BZ-2R5551-P4	BZ-2RL-A2	BZ-2RQ18-T4-J
BA-1R357	BA-2SV22T	BM-2R559729-A4	BZ-2R5551T	BZ-2RL-P4	BZ-2RQ18UL
BA-1R7223524-A2	BA-3RBX	BM-2RM50-A2	BZ-2R559729	BZ-2RLT	BZ-2RQ1-A2
BA-1RV111-A2	BA-3RX717	BM-2RQ1-A2	BZ-2R559729-A4	BZ-2RLT04	BZ-2RQ1-D6
BA-1RV133-A4	BA-3SQ1T	BM-2RW82255512429-A4	BZ-2R55-A2-S	BZ-2RM	BZ-2RQ1-D682
BA-1RV543510-A2	BA-3ST	BM-2RW8424-A2	BZ-2R55-P4-S	BZ-2RM2	BZ-2RQ1MA2
BA-1RV543512-A2	BA-5RV310-A2	BM-2RW8424-A2	BZ-2R708-P7	BZ-2RM22	BZ-2RQ1M-A2RS
BA-1RV54352411-A21	BA-R138-A2	BM-2RW855-D6	BZ-2R710-PC2	BZ-2RM22-A2	BZ-2RQ1-P4
BA-1RV5435241-A2	BA-R358-A2	BZ-1R2448-A2	BZ-2R722331	BZ-2RM2-A2	BZ-2RQ1T
BA-1RV5435246-A2	BA-R82-D685	BZ-1R2452-A2	BZ-2R725551	BZ-2RM31	BZ-2RQ1T04
BA-1RV5435247-A2	BE-1R242-A46	BZ-1R374-P4	BZ-2R725551-A2	BZ-2RM-A2	BZ-2RQ233-A2
BA-2CB708-A2	BE-1RV320-A4	BZ-1R5421-A2	BZ-2R72-A2	BZ-2R-N108	BZ-2RQ239-A2
BA-2R	BE-1RV52-A4	BZ-1R95-A21	BZ-2R73-A21	BZ-2R-N114	BZ-2RQ241-D5
BA-2R164-A4	BE-2R	BZ-1RDN930	BZ-2R-A2	BZ-2R-N124	BZ-2RQ24-A2
BA-2R24-A2	BE-2R057-A41	BZ-1RD-N930	BZ-2R-A22	BZ-2RN317-P4	BZ-2RQ24-D5
BA-2R280-A2	BE-2R059-A41	BZ-1RW80-A2N163	BZ-2R-A22F1	BZ-2RN702	BZ-2RQ25272T
BA-2R281-A2	BE-2R2425	BZ-1RW8255051T-S	BZ-2R-A2F1	BZ-2RN702-N2	BZ-2RQ3001-T4-JK
BA-2R708-P7	BE-2R25-A4	BZ-1RW82991T	BZ-2R-A2N100	BZ-2RN730	BZ-2RQ3002-T4-JK
BA-2R-A2	BE-2R-A4	BZ-1RW82991-T	BZ-2R-A2N101	BZ-2RN770	BZ-2RQ66
BA-2R-A4	BE-2RB	BZ-1RW8472A2N166	BZ-2R-A2N113	BZ-2RN784	BZ-2RQ66-N26
BA-2RB	BE-2RB19-A2	BZ-2ADT1	BZ-2R-A2N74	BZ-2RN787	BZ-2RQ68
BA-2RB35-A2	BE-2RB232-A4	BZ-2AQ1842-PC2	BZ-2R-A2N80	BZ-2RN87	BZ-2RQ69
BA-2RB7-P4	BE-2RB-A2	BZ-2AQ18T1	BZ-2RD	BZ-2R-N87	BZ-2RQ722233-A2
BA-2RB-A2	BE-2RB-A4	BZ-2AQ1T	BZ-2RD23-A2	BZ-2R-N88	BZ-2RQ72266
BA-2RB-A4	BE-2RL-A4	BZ-2AQ784T	BZ-2RD244T1	BZ-2RN918	BZ-2RQ722-A2
BA-2RB-P4	BE-2R-P4	BZ-2AT	BZ-2RD24-A2	BZ-2RN-A2	BZ-2RQ77
BA-2RL	BE-2RQ1-A2	BZ-2AW822551-D6	BZ-2RD331	BZ-2R-P1	BZ-2RQ772
BA-2RL2-A2	BE-2RQ1-A4	BZ-2AW822556T	BZ-2RD39-A2	BZ-2R-P4	BZ-2RQ77N23
BA-2RL-A2	BE-2RV193-A4	BZ-2AW822T	BZ-2RD42-P4	BZ-2R-P5	BZ-2RQ77-N24
BA-2R-P1	BE-2RV22-A2	BZ-2AW825551T	BZ-2RD44-PC2	BZ-2R-P7	BZ-2RQ784
BA-2R-P4	BE-2RV22-A4	BZ-2AW82T	BZ-2RD45	BZ-2RQ	BZ-2RQ785
BA-2R-P7	BE-2RV24-A2	BZ-2AW84223T	BZ-2R-D5	BZ-2RQ1	BZ-2RQ81A2
BA-2RQ1	BE-2RV2-A4	BZ-2AW842444T	BZ-2RD72-A2	BZ-2RQ1004-A2	BZ-2RQ81-A2
BA-2RQ1250-A2	BE-2RV5-A2	BZ-2AW8557-D6	BZ-2RD-A2	BZ-2RQ1008-A2	BZ-2RQ8-A2
BA-2RQ1-A2	BE-2RV-A2	BZ-2AW8558-D6	BZ-2RD-A2N11	BZ-2RQ1015-W109	BZ-2RQ9-A2
BA-2RQ1-D5	BE-2RV-A4	BZ-2AW855-D6	BZ-2RD-D5	BZ-2RQ1016-W119	BZ-2RQ-A2
BA-2RQ1T	BE-R0512-A2	BZ-2AW855T1	BZ-2RD-D6	BZ-2RQ1017-A2	BZ-2RQ-A2N11
BA-2RT	BE-R0512-D69	BZ-2G-A2	BZ-2RD-D82	BZ-2RQ104	BZ-2RQ-A2N19
BA-2RV	BE-R0512-D691	BZ-2GW822	BZ-2RD-N930	BZ-2RQ115-A2	BZ-2RQ-A2N9
BA-2RV136-A2	BE-R205	BZ-2R	BZ-2RD-P1	BZ-2RQ124-A2	BZ-2RQW10-A2
BA-2RV191-A2	BE-R2420-A2	BZ-2R15-A6	BZ-2RD-P4	BZ-2RQ124-D6	BZ-2RQW15-A2
BA-2RV219-D68	BE-R24-A4	BZ-2R168-A2	BZ-2RD-PC2	BZ-2RQ128T	BZ-2RQW1-A2
BA-2RV22	BF-10032	BZ-2R21-A2	BZ-2RDS	BZ-2RQ1331	BZ-2RQW558-W103
BA-2RV2223-A2	BM-1R	BZ-2R244-A2	BZ-2RDS24-S	BZ-2RQ13-A2	BZ-2RQW55-W103
BA-2RV2233T	BM-1R231-A4	BZ-2R244-P1	BZ-2RDS5551-A2	BZ-2RQ172-A2	BZ-2RS
BA-2RV22-A2	BM-1R2420	BZ-2R244T	BZ-2RDS725551-A2	BZ-2RQ172-D6	BZ-2RS331
BA-2RV22-D6	BM-1R2450	BZ-2R24-A2	BZ-2RDS-A2-S	BZ-2RQ172-D625	BZ-2RS551-A2
BA-2RV22-D81	BM-1R369-A41	BZ-2R24-A2N84	BZ-2RDST-S	BZ-2RQ174-A2	BZ-2RS55A2
BA-2RV22T	BM-1R373	BZ-2R258	BZ-2RDT	BZ-2RQ18	BZ-2RS55-A2-S
BA-2RV241-A2	BM-1R378-P4	BZ-2R268-A2	BZ-2RD-T4-J	BZ-2RQ181	BZ-2RS7224-A2
BA-2RV2-A2	BM-1R392-A2	BZ-2R276-P5	BZ-2RD-WCBA-240	BZ-2RQ181-A2	BZ-2RS72-A2
BA-2RV301-PC2	BM-1R-A2	BZ-2R291-A4	BZ-2RD-WCBA-720	BZ-2RQ181-D5	BZ-2RS-A2
BA-2RV303	BM-1R-A4	BZ-2R291-P4	BZ-2RD-WFDE-240	BZ-2RQ181M	BZ-2RS-P1

BZ | BA | BM | BE | 6AS Series

BZ-2RS-P4	BZ-2RW822555114-W117	BZ-2RW82-A2	BZ-3RS	BZ-7RW8055151-A2-S	BZ-R-A2
BZ-2RST04	BZ-2RW8225551-A2	BZ-2RW82-A2N131	BZ-3RW80155551-A2-S	BZ-7RW80A2F1	BZ-R-A2N104
BZ-2RS-T4-J	BZ-2RW8225551-A46	BZ-2RW82-D5	BZ-3RW80551-A2-S	BZ-7RW80-A2N164	BZ-R-A2N110
BZ-2RT	BZ-2RW8225551-D6	BZ-2RW82T	BZ-3RW80552-A2-S	BZ-7RW82127T-S	BZ-R-A2N112
BZ-2RT04	BZ-2RW8225551-T	BZ-2RW822-R4-J	BZ-3RW8055-A2-S	BZ-7RW82132T-S	BZ-R-A2N117
BZ-2R-T4-J	BZ-2RW8225551T	BZ-2RW84	BZ-3RW82134-A2	BZ-7RW82135-A2	BZ-RD
BZ-2RW0172-J	BZ-2RW8225551-W103	BZ-2RW8405-A2	BZ-3RW822155112D6S	BZ-7RW822155516T-S	BZ-RD178
BZ-2RW53-A2	BZ-2RW82255721W122	BZ-2RW84118-A41	BZ-3RW82215555111T-S	BZ-7RW82255518T	BZ-RD242
BZ-2RW53-A2RS	BZ-2RW82255A2	BZ-2RW842216-D6	BZ-	BZ-7RW8225551-D6	BZ-RD24-A4
BZ-2RW80	BZ-2RW82255-A2-S	BZ-2RW8422-A2	3RW82215555112D6S	BZ-7RW822-A2	BZ-RD722-A2
BZ-2RW80136-A2	BZ-2RW82255-S	BZ-2RW8424501-A2	BZ-3RW8221555513T	BZ-7RW82550511PC2S	BZ-RD-A2
BZ-2RW80147-A2	BZ-2RW82255T-S	BZ-2RW8424511-A2	BZ-3RW8221555513T-S	BZ-7RW82550519-A2-S	BZ-RD-A2N10
BZ-2RW80147-P4	BZ-2RW8225-A2-S	BZ-2RW8435145T	BZ-3RW822158-A46	BZ-7RW825520-A2-S	BZ-RF3
BZ-2RW80161-A2	BZ-2RW82262T	BZ-2RW843589-P4	BZ-3RW822-A2	BZ-7RW84449-A2	BZ-R-F3
BZ-2RW80172-A2	BZ-2RW82271	BZ-2RW8435-A2	BZ-3RW822T	BZ-7RW84-A2	BZ-R-J
BZ-2RW80196-A2	BZ-2RW82272100-A2	BZ-2RW84375T	BZ-3RW825515-A2-S	BZ-7RW855T-S	BZ-RL
BZ-2RW80198T	BZ-2RW822725551	BZ-2RW84429-P52	BZ-3RW8995516-PC2-S	BZ-7RW80	BZ-RL95
BZ-2RW80225-A2	BZ-2RW82272555124-A2	BZ-2RW84441-A2	BZ-3RW899555110PC2-S	BZ-7RWT80	BZ-RLX
BZ-2RW80231-A2	BZ-2RW822725551-A2	BZ-2RW84449-A2	S	BZ-7RWT822	BZ-RMX
BZ-2RW80233-A2	BZ-2RW822725551-A46	BZ-2RW8446072-PC2	BZ-3YDT	BZ-7RWT822101	BZ-RMX23-A29
BZ-2RW8024	BZ-2RW82272-A2	BZ-2RW84462-A2	BZ-3YN702	BZ-7RX-N2	BZ-RMX4
BZ-2RW80259-A2	BZ-2RW82272D5	BZ-2RW84467-A2	BZ-3YN703	BZ-7RX-N3	BZ-RMX4-A29
BZ-2RW80282-A2	BZ-2RW82272-D5	BZ-2RW84512T	BZ-3YQ18T	BZ-7YQ1T1	BZ-RMX6-B7
BZ-2RW80283-PC2	BZ-2RW82276T	BZ-2RW84514-A2	BZ-3YQ1T	BZ-R	BZ-R-N111
BZ-2RW80288-A2	BZ-2RW82279-A21	BZ-2RW84514-A22	BZ-3YQ66T	BZ-R1691	BZ-R-N115
BZ-2RW80331	BZ-2RW82291-A2	BZ-2RW8478-D5	BZ-3YQ67T	BZ-R1692	BZ-R-N86
BZ-2RW8055285T-S	BZ-2RW822995-A2	BZ-2RW8497-A2	BZ-3YQ68T	BZ-R169-N78	BZ-RN917
BZ-2RW80555110T	BZ-2RW82299-A2	BZ-2RW84-A2	BZ-3YQ69T	BZ-R169-WCBA-060-T	BZ-R-N917
BZ-2RW80555113-A2	BZ-2RW822-A2	BZ-2RW84T	BZ-3YQ8T	BZ-R173-A4	BZ-RN953
BZ-2RW8055513-A2	BZ-2RW822-A2N138	BZ-2RW855	BZ-3YST	BZ-R173-P4	BZ-R-N953
BZ-2RW8055513T	BZ-2RW822-D5	BZ-2RW855051-A2-S	BZ-3YT	BZ-R178	BZ-R-P4
BZ-2RW8055513-W118	BZ-2RW822-D612	BZ-2RW855511T	BZ-3YT552	BZ-R178-WCBA-030-T	BZ-RQ1-A2
BZ-2RW8055516T	BZ-2RW822-P4	BZ-2RW855A2	BZ-3YWT82	BZ-R178-WCBA-060-T	BZ-RQ1T04
BZ-2RW8055517-A2	BZ-2RW822T	BZ-2RW855-A2-S	BZ-3YWT822	BZ-R178-WCBA-240	BZ-RQ1X
BZ-2RW80555196T	BZ-2RW822-T4-J	BZ-2RW855-P4-S	BZ-5RW822A2F2	BZ-R178-WFDE-050-T	BZ-RQ66
BZ-2RW805551-A2	BZ-2RW8238-A2	BZ-2RW855-S	BZ-5RW822-A2F2	BZ-R178-WFDE-240	BZ-RQ69
BZ-2RW8055520T	BZ-2RW82443-A2	BZ-2RW855T-S	BZ-5RW84A2N161	BZ-R179	BZ-RQ-A2
BZ-2RW8072224286-A2	BZ-2RW82444-A2	BZ-2RW863	BZ-5RW84-A2N161	BZ-R179-WCBA-060-T	BZ-RQX
BZ-2RW80722555105-A2	BZ-2RW8244-A2	BZ-2RW86324-A2	BZ-7R24-A2	BZ-R179-WCBA-240	BZ-RQX167
BZ-2RW8072-A2	BZ-2RW8244-P4	BZ-2RW8635551-A2	BZ-7R277	BZ-R179-WFDE-060-T	BZ-RQX66
BZ-2RW80-A2	BZ-2RW824-A2	BZ-2RW863-A2	BZ-7R331	BZ-R179-WFDE-240	BZ-RS
BZ-2RW80-A2N130	BZ-2RW825	BZ-2RW863T	BZ-7R336T	BZ-R19-A2	BZ-RS66
BZ-2RW80A2UL	BZ-2RW8253312	BZ-2RW8761-A2	BZ-7R35-A4	BZ-R20	BZ-RS72-N9
BZ-2RW80-A2UL	BZ-2RW8255	BZ-2RW876-PC2	BZ-7R55T-S	BZ-R21	BZ-RS801-A2
BZ-2RW80-D5	BZ-2RW825518-A2-S	BZ-2RW876T	BZ-7R-A2	BZ-R2136-P1	BZ-RS-A2
BZ-2RW8155551-A2	BZ-2RW82555110-A2	BZ-2RW881T	BZ-7R-A2N128	BZ-R2137-A2	BZ-RS-A2N8
BZ-2RW82	BZ-2RW82555110T	BZ-2RW896-A2	BZ-7R-A2N130	BZ-R214	BZ-RSN10
BZ-2RW82113T	BZ-2RW82555111-A2	BZ-2RW897-A2	BZ-7R-A2N131	BZ-R21-A2	BZ-RS-N10
BZ-2RW82120-A21	BZ-2RW82555111-A46	BZ-2RW89999-A2	BZ-7RD-A2	BZ-R2411	BZ-RSX
BZ-2RW82128-T	BZ-2RW8255516-A2	BZ-2RW899-A2	BZ-7RL127	BZ-R2411-A4	BZ-RT04
BZ-2RW82155551-A2	BZ-2RW8255517-T	BZ-2RWT04	BZ-7RL13072T	BZ-R2430	BZ-RW53-A2
BZ-2RW8219-A2	BZ-2RW825551-A2	BZ-2RWT80	BZ-7RL367T	BZ-R2430-P1	BZ-RW80331
BZ-2RW822	BZ-2RW825551-D6	BZ-3A55T	BZ-7RL36872T	BZ-R2439-P4	BZ-RW80722-A2
BZ-2RW822102-A2	BZ-2RW82555T-S	BZ-3AD-PC2	BZ-7RLT04	BZ-R30372-PC2	BZ-RW80-A2
BZ-2RW82212-A2	BZ-2RW8255A2	BZ-3ALT1	BZ-7RLT711	BZ-R31	BZ-RW80-A2N144
BZ-2RW82212T	BZ-2RW8255-A2	BZ-3AST	BZ-7R-N89	BZ-R330-P4	BZ-RW80-A2N155
BZ-2RW82215-P12	BZ-2RW8255-A2-S	BZ-3AT	BZ7-RN89	BZ-R370-P5	BZ-RW80-A2N156
BZ-2RW82215T	BZ-2RW8255T-S	BZ-3AW8055511T	BZ-7R-P5	BZ-R546-D6	BZ-RW80X
BZ-2RW822244-A2	BZ-2RW825-A2	BZ-3AW805551T	BZ-7RQ1	BZ-R55511-A4	BZ-RW80X37-A29
BZ-2RW82224-A2	BZ-2RW826	BZ-3AW82254T	BZ-7RQ144T	BZ-R55514-P4	BZ-RW82051-A2
BZ-2RW8222-A2	BZ-2RW826-A2	BZ-3R	BZ-7RQ181T	BZ-R55-A2-S	BZ-RW822
BZ-2RW8223312	BZ-2RW826-A2RS	BZ-3R2446	BZ-7RQ18T	BZ-R55-P4-S	BZ-RW822-A2
BZ-2RW82244-A2	BZ-2RW826T	BZ-3R-A2	BZ-7RQ1T	BZ-R55-S	BZ-RW822-P4
BZ-2RW82255	BZ-2RW82725551-A2	BZ-3RD-A2	BZ-7RST	BZ-R7216	BZ-RW84
BZ-2RW822551529T-S	BZ-2RW82725551-D6	BZ-3RDS152T-S	BZ-7RT04	BZ-R7216-P5	BZ-RW8405-A2
BZ-2RW8225534-W123	BZ-2RW828-A2	BZ-3RDS15T-S	BZ-7RW204	BZ-R812	BZ-RW842
BZ-2RW8225551	BZ-2RW8292	BZ-3RQ115T	BZ-7RW2T04	BZ-R88	BZ-RW842214-P4
BZ-2RW822555114-A46	BZ-2RW8299-A2	BZ-3RQ1-A2	BZ-7RW80189-A2	BZ-R88-A2	BZ-RW842214-P5

MICRO SWITCH™ Premium Large Basic Switches

BZ-RW8422-A2	BZ-RW-F1	WM-1RW88294T	YE-2RB-A4
BZ-RW8422-P4	BZ-RW-F3	WZ-2RD19-D1	YE-2RQ27-A4
BZ-RW8435	BZ-RX	WZ-2RQ15-A2	YE-2RV198-A41
BZ-RW8435113-A2-1	BZ-RX122	WZ-2RQ1846	YE-2RV22-D5
BZ-RW8435149-A2	BZ-RX122-A29	WZ-2RQ1T	YE-2RV248-D6
BZ-RW8435149-D6	BZ-RX20	WZ-2RQW55-W104	YM-1R2450
BZ-RW843515	BZ-RX243	WZ-2RW822-A2	YM-1R-A2
BZ-RW8435161-A2	BZ-RX43	WZ-2RW84429-P52	YZ-2R296-A2
BZ-RW8435164-A2	BZ-RX47	WZ-3RW8221555514T-S	YZ-2R5556T
BZ-RW843517372-A21	BZ-RX48	WZ-R	YZ-2R-A2
BZ-RW8435-A2	BZ-RX53-B7	WZ-R141	YZ-2R-A21
BZ-RW84411-A2	BZ-RX9	WZ-R296	YZ-2RDS4
BZ-RW84414-A2	BZ-RX-D584	YA-1R5435242-A2	YZ-2RDS5551-D6
BZ-RW84431-A2	BZ-RX-F1	YA-2CB16-A2	YZ-2RL
BZ-RW84461-A2	WA-1R249-A42	YA-2CB713-A2	YZ-2RQ1T
BZ-RW847225-A2	WA-1RVX051-A4	YA-2R-A2	YZ-2RQW-A2
BZ-RW84-A2	WA-1RVX132-A4	YA-2RB18-A21	YZ-2RS-A2
BZ-RW84-A2N145	WA-1RX123-A4	YA-2RB19-A64	YZ-2RW805551T
BZ-RW84-A2N157	WA-1RX12-A4	YA-2RB-A2	YZ-2RW812-A2
BZ-RW84-N108	WA-1RX12-A41	YA-2RB-A64	YZ-2RW822-A2
BZ-RW84-N20	WA-1RX33-A4	YA-2RB-D504	YZ-2RW82725551-D6
BZ-RW84-N94	WA-1RX38-A41	YA-2RBT	YZ-2RW8435114-D5-S
BZ-RW84X33	WA-1RX-A4	YA-2RL-A6	YZ-2RW84-A2
BZ-RW85X2	WA-1RX-A41	YA-2RL-P4	YZ-2RW863-A2
BZ-RW889	WA-2R-A2	YA-2RQ1243-D6	YZ-3RW845547-A2-S
BZ-RW9221	WA-2R-A21	YA-2RQ1-A2	YZ-7RW8221555516T-S
BZ-RW9223312	WA-2RV178-A2	YA-2RQ81245-D6	YZ-R
BZ-RW922-A2	WA-2RV313-A22	YA-2RV54321-D6	YZ-RSX351
BZ-RW922-P4	WM-1R369-AR2	YA-3R64-A2	YZ-RX58-D5
BZ-RW925	WM-1R369-AR4	YE-2RB-A2	YZ-RX-D584

ADDITIONAL INFORMATION

The following associated literature is available at sensing.honeywell.com:

- Product installation instructions
- Product application-specific information
 - Sensors and switches for potential HVAC/R applications
 - Sensors and switches for valve monitors and valve indicators
 - Sensors and switches in oil rig applications
 - Sensors and switches in sanitary valves
- Case study
 - A good range of mobility - BZ Series
- BZ/BA performance information
- Applying basic switches
- Low energy switching guide
- Product range guide

WARNING

PERSONAL INJURY

DO NOT USE these products as safety or emergency stop devices or in any other application where failure of the product could result in personal injury.

Failure to comply with these instructions could result in death or serious injury.

WARNING

MISUSE OF DOCUMENTATION

- The information presented in this product sheet is for reference only. Do not use this document as a product installation guide.
- Complete installation, operation, and maintenance information is provided in the instructions supplied with each product.

Failure to comply with these instructions could result in death or serious injury.

WARRANTY/REMEDY

Honeywell warrants goods of its manufacture as being free of defective materials and faulty workmanship. Honeywell's standard product warranty applies unless agreed to otherwise by Honeywell in writing; please refer to your order acknowledgement or consult your local sales office for specific warranty details. If warranted goods are returned to Honeywell during the period of coverage, Honeywell will repair or replace, at its option, without charge those items it finds defective. **The foregoing is buyer's sole remedy and is in lieu of all other warranties, expressed or implied, including those of merchantability and fitness for a particular purpose. In no event shall Honeywell be liable for consequential, special, or indirect damages.**

While we provide application assistance personally, through our literature and the Honeywell website, it is up to the customer to determine the suitability of the product in the application.

Specifications may change without notice. The information we supply is believed to be accurate and reliable as of this printing. However, we assume no responsibility for its use.

Find out more

Honeywell serves its customers through a worldwide network of sales offices, representatives and distributors. For application assistance, current specifications, pricing or name of the nearest Authorized Distributor, contact your local sales office.

To learn more about Honeywell's sensing and control products, call **+1-815-235-6847** or **1-800-537-6945**, visit **sensing.honeywell.com**, or e-mail inquiries to **info.sc@honeywell.com**

Sensing and Control
Honeywell
1985 Douglas Drive North
Golden Valley, MN 55422
honeywell.com

Honeywell

004955-2-EN IL50 GLO
September 2013
Copyright © 2013 Honeywell International Inc. All rights reserved.