



ENGLISH

Datasheet

Stock No: 9182684

RS Pro Grade 2 Surface mount alarm contact

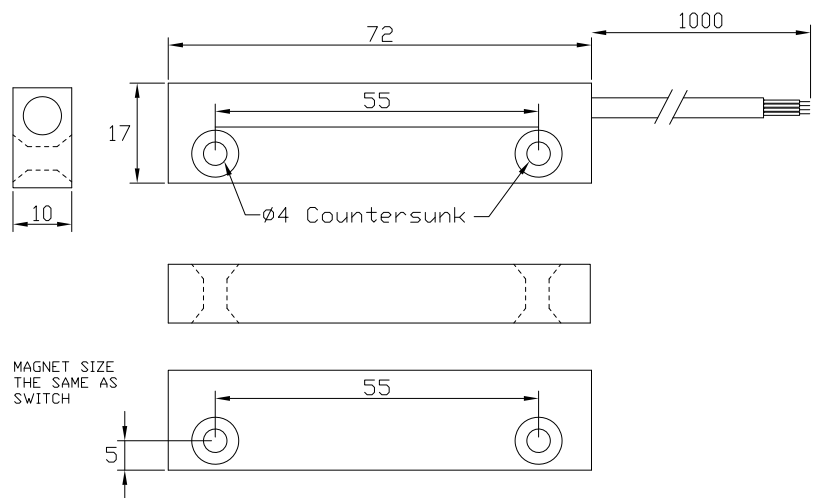

Specifications

- Normally open + supervisory loop
- Grade 2
- Maximum switching voltage 50 VAC/ DC
- Maximum switching current 0.5 Amps
- Carry current Max 0.8 Amp
- Maximum power 10 W/VA
- Insulation resistance 100 MOhms
- Contact resistance 120 mOhms
- Operating distance 30mm
- Operating temperature -40° to $+85^{\circ}$ Celsius
- Aluminium housing material