

NUF2101M

USB Filter with ESD Protection

This device is designed for applications requiring **Line Termination**, **EMI Filtering** and **ESD Protection**. It is intended for use in downstream USB 1.1 ports, Cellular phones, Wireless equipment and computer applications. This device offers an integrated solution in a small package (TSOP-6, Case 318G) reducing PCB space and cost.

Features:

- Provides USB Line Termination, Filtering and ESD Protection
- Single IC Offers Cost Savings by Replacing 4 Resistors, 2 Capacitors, and 5 TVs diodes
- EMI Filtering Prevents Noise from Entering/Leaving the System
- IEC61000-4-2 (Level 4)
 - 8 kV (Contact)
 - 15 kV (Air)
- ESD Ratings: Machine Model = C
 - Human Body Model = 3B
- Pb-Free Package is Available

Benefits:

- TSOP-6 Package Minimizes PCB Space
- Integrated Circuit Increases System Reliability versus Discrete Component Implementation
- TVs Devices Provide ESD Protection That is Better than a Discrete Implementation because the Small IC minimizes Parasitic Inductances

Typical Applications:

- USB Hubs
- Computer Motherboards

MAXIMUM RATINGS ($T_A = 25^\circ\text{C}$)

| Rating | Symbol | Value | Unit |
|---|--------------|-------------|------------------|
| Steady State Power | P_D | 225 | mW |
| Maximum Junction Temperature | $T_{J(max)}$ | 125 | $^\circ\text{C}$ |
| Operating Temperature Range | T_J | -55 to +125 | $^\circ\text{C}$ |
| Storage Temperature Range | T_{stg} | -55 to +125 | $^\circ\text{C}$ |
| Lead Solder Temperature (10 second duration) | T_L | 260 | $^\circ\text{C}$ |

Maximum ratings are those values beyond which device damage can occur. Maximum ratings applied to the device are individual stress limit values (not normal operating conditions) and are not valid simultaneously. If these limits are exceeded, device functional operation is not implied, damage may occur and reliability may be affected.



ON Semiconductor®

<http://onsemi.com>

SCHEMATIC

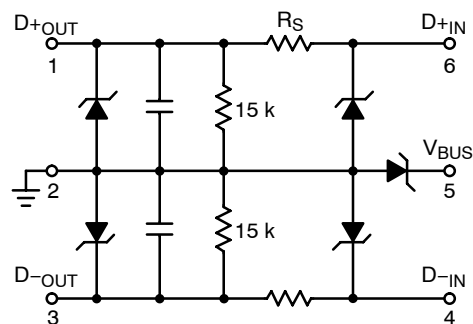

TSOP-6
CASE 318G
STYLE 10

MARKING DIAGRAM

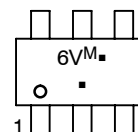

6V = Specific Device Code
M = Date Code
▪ = Pb-Free Package
(Note: Microdot may be in either location)

ORDERING INFORMATION

| Device | Package | Shipping† |
|-------------|---------------------|------------------|
| NUF2101MT1 | TSOP-6 | 3000/Tape & Reel |
| NUF2101MT1G | TSOP-6 (Pb-Free) | 3000/Tape & Reel |

†For information on tape and reel specifications, including part orientation and tape sizes, please refer to our Tape and Reel Packaging Specification Brochure, BRD8011/D.

NUF2101M

ELECTRICAL CHARACTERISTICS (T_A = 25°C)

| Device | Device Marking | V _{RWM} (Volts) | V _{BR} @ 1 mA (Volts) | | Max I _R @ V _{RWM} = 5.25 V V _{BUS} to GND (μA) | Max I _R @ V _{RWM} = 3.3 V V _{BUS} Pin (μA) | Typical Line Capacitance (pF) (Notes 2, 3) | Series Resistor R _S (Ω) (Note 1) | | | Pulldown Resistor R _{pd} (kΩ) | | |
|-------------|----------------|--------------------------|--------------------------------|-----|---|---|---|---|-----|------|--|-----|-----|
| | | | Min | Max | | | | Min | Nom | Max | Min | Nom | Max |
| NUF2101MT1 | 6V | 5.25 | 6.0 | 8.0 | 1.0 | 0.1 | 55 | 26.3 | 30 | 33.7 | 13 | 15 | 17 |
| NUF2101MT1G | 6V | 5.25 | 6.0 | 8.0 | 1.0 | 0.1 | 55 | 26.3 | 30 | 33.7 | 13 | 15 | 17 |

1. For other R_S values (i.e. R_S = 30 Ω) contact your local ON Semiconductor sales representative.
2. Measured at 25°C, V_R = 0 V, f = 1 MHz, Pins 2, 3, 4 or 5 to GND with Pin 1 also grounded.
3. For other capacitance values contact your local ON Semiconductor sales representative.

NUF2101M

TYPICAL CHARACTERISTICS

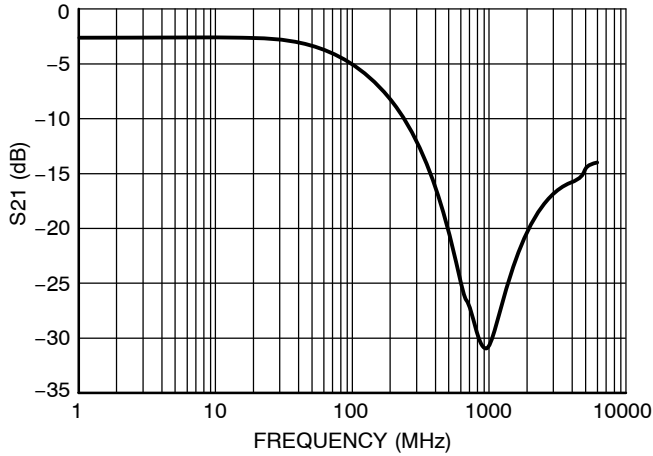

Figure 1. Insertion Loss Characteristics

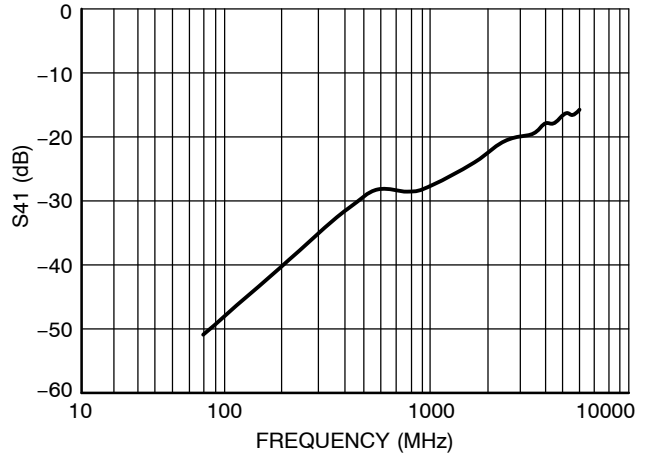

Figure 2. Analog Cross-Talk

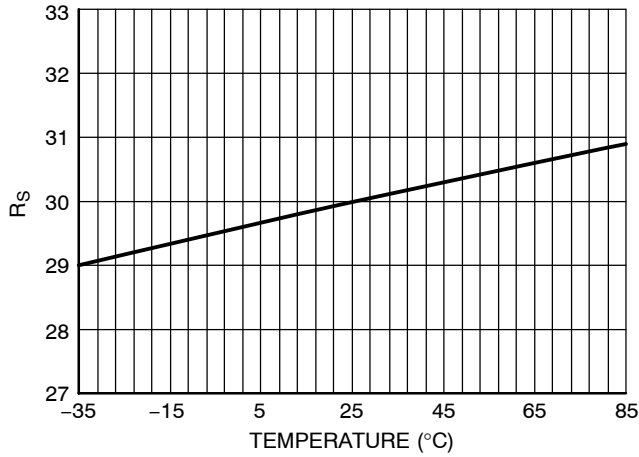

Figure 3. R_S vs. Temperature

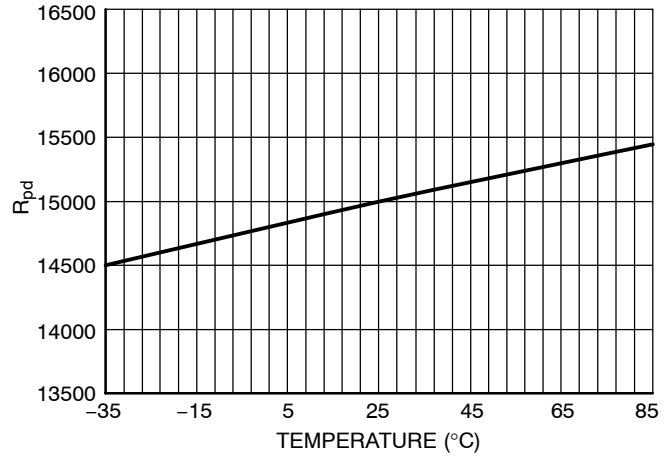

Figure 4. R_{pd} vs. Temperature

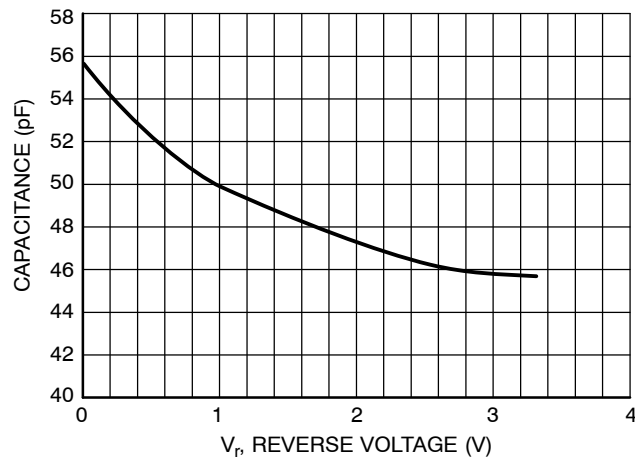

Figure 5. Typical Capacitance

MECHANICAL CASE OUTLINE

PACKAGE DIMENSIONS

ON Semiconductor®



SCALE 2:1

TSOP-6 CASE 318G-02 ISSUE V

DATE 12 JUN 2012

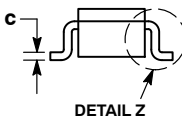
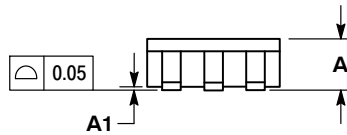
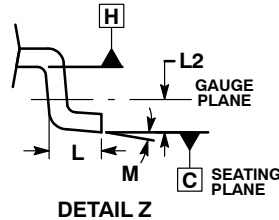
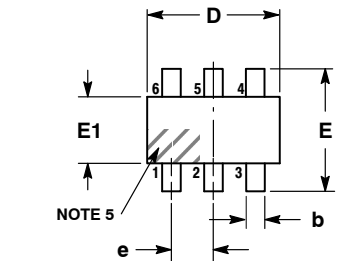

NOTES:

1. DIMENSIONING AND TOLERANCING PER ASME Y14.5M, 1994.
2. CONTROLLING DIMENSION: MILLIMETERS.
3. MAXIMUM LEAD THICKNESS INCLUDES LEAD FINISH. MINIMUM LEAD THICKNESS IS THE MINIMUM THICKNESS OF BASE MATERIAL.
4. DIMENSIONS D AND E1 DO NOT INCLUDE MOLD FLASH, PROTRUSIONS, OR GATE BURRS. MOLD FLASH, PROTRUSIONS, OR GATE BURRS SHALL NOT EXCEED 0.15 PER SIDE. DIMENSIONS D AND E1 ARE DETERMINED AT DATUM H.
5. PIN ONE INDICATOR MUST BE LOCATED IN THE INDICATED ZONE.

| DIM | MILLIMETERS | | |
|-----|-------------|------|------|
| | MIN | NOM | MAX |
| A | 0.90 | 1.00 | 1.10 |
| A1 | 0.01 | 0.06 | 0.10 |
| b | 0.25 | 0.38 | 0.50 |
| c | 0.10 | 0.18 | 0.26 |
| D | 2.90 | 3.00 | 3.10 |
| E | 2.50 | 2.75 | 3.00 |
| E1 | 1.30 | 1.50 | 1.70 |
| e | 0.85 | 0.95 | 1.05 |
| L | 0.20 | 0.40 | 0.60 |
| L2 | 0.25 BSC | | |
| M | 0° | - | 10° |

- | | | | | | |
|--|--|---|---|---|--|
| <p>STYLE 1: PIN 1. DRAIN 2. DRAIN 3. GATE 4. SOURCE 5. DRAIN 6. DRAIN</p> | <p>STYLE 2: PIN 1. EMITTER 2 2. BASE 1 3. COLLECTOR 1 4. EMITTER 1 5. BASE 2 6. COLLECTOR 2</p> | <p>STYLE 3: PIN 1. ENABLE 2. N/C 3. R BOOST 4. Vz 5. V in 6. V out</p> | <p>STYLE 4: PIN 1. N/C 2. V in 3. NOT USED 4. GROUND 5. ENABLE 6. LOAD</p> | <p>STYLE 5: PIN 1. EMITTER 2 2. BASE 2 3. COLLECTOR 1 4. EMITTER 1 5. BASE 1 6. COLLECTOR 2</p> | <p>STYLE 6: PIN 1. COLLECTOR 2. COLLECTOR 3. BASE 4. EMITTER 5. COLLECTOR 6. COLLECTOR</p> |
| <p>STYLE 7: PIN 1. COLLECTOR 2. COLLECTOR 3. BASE 4. N/C 5. COLLECTOR 6. EMITTER</p> | <p>STYLE 8: PIN 1. Vbus 2. D(in) 3. D(in)+ 4. D(out)+ 5. D(out) 6. GND</p> | <p>STYLE 9: PIN 1. LOW VOLTAGE GATE 2. DRAIN 3. SOURCE 4. DRAIN 5. DRAIN 6. HIGH VOLTAGE GATE</p> | <p>STYLE 10: PIN 1. D(OUT)+ 2. GND 3. D(OUT)- 4. D(IN)- 5. VBUS 6. D(IN)+</p> | <p>STYLE 11: PIN 1. SOURCE 1 2. DRAIN 2 3. DRAIN 2 4. SOURCE 2 5. GATE 1 6. DRAIN 1/GATE 2</p> | <p>STYLE 12: PIN 1. I/O 2. GROUND 3. I/O 4. I/O 5. VCC 6. I/O</p> |
| <p>STYLE 13: PIN 1. GATE 1 2. SOURCE 2 3. GATE 2 4. DRAIN 2 5. SOURCE 1 6. DRAIN 1</p> | <p>STYLE 14: PIN 1. ANODE 2. SOURCE 3. GATE 4. CATHODE/DRAIN 5. CATHODE/DRAIN 6. CATHODE/DRAIN</p> | <p>STYLE 15: PIN 1. ANODE 2. SOURCE 3. GATE 4. DRAIN 5. N/C 6. CATHODE</p> | <p>STYLE 16: PIN 1. ANODE/CATHODE 2. BASE 3. EMITTER 4. COLLECTOR 5. ANODE 6. CATHODE</p> | <p>STYLE 17: PIN 1. EMITTER 2. BASE 3. ANODE/CATHODE 4. ANODE 5. CATHODE 6. COLLECTOR</p> | |

RECOMMENDED SOLDERING FOOTPRINT*

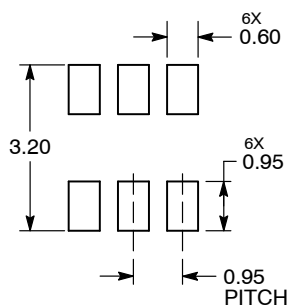

DIMENSIONS: MILLIMETERS

GENERIC MARKING DIAGRAM*



- | | |
|--|---|
| <p>XXX = Specific Device Code A = Assembly Location Y = Year W = Work Week ▪ = Pb-Free Package</p> | <p>XXX = Specific Device Code M = Date Code ▪ = Pb-Free Package</p> |
|--|---|

*For additional information on our Pb-Free strategy and soldering details, please download the ON Semiconductor Soldering and Mounting Techniques Reference Manual, SOLDERRM/D.

*This information is generic. Please refer to device data sheet for actual part marking. Pb-Free indicator, "G" or microdot "▪", may or may not be present.

| | | |
|------------------|-------------|--|
| DOCUMENT NUMBER: | 98ASB14888C | Electronic versions are uncontrolled except when accessed directly from the Document Repository. Printed versions are uncontrolled except when stamped "CONTROLLED COPY" in red. |
| DESCRIPTION: | TSOP-6 | PAGE 1 OF 1 |

ON Semiconductor and ON are trademarks of Semiconductor Components Industries, LLC dba ON Semiconductor or its subsidiaries in the United States and/or other countries. ON Semiconductor reserves the right to make changes without further notice to any products herein. ON Semiconductor makes no warranty, representation or guarantee regarding the suitability of its products for any particular purpose, nor does ON Semiconductor assume any liability arising out of the application or use of any product or circuit, and specifically disclaims any and all liability, including without limitation special, consequential or incidental damages. ON Semiconductor does not convey any license under its patent rights nor the rights of others.

ON Semiconductor and  are trademarks of Semiconductor Components Industries, LLC dba ON Semiconductor or its subsidiaries in the United States and/or other countries. ON Semiconductor owns the rights to a number of patents, trademarks, copyrights, trade secrets, and other intellectual property. A listing of ON Semiconductor's product/patent coverage may be accessed at www.onsemi.com/site/pdf/Patent-Marking.pdf. ON Semiconductor reserves the right to make changes without further notice to any products herein. ON Semiconductor makes no warranty, representation or guarantee regarding the suitability of its products for any particular purpose, nor does ON Semiconductor assume any liability arising out of the application or use of any product or circuit, and specifically disclaims any and all liability, including without limitation special, consequential or incidental damages. Buyer is responsible for its products and applications using ON Semiconductor products, including compliance with all laws, regulations and safety requirements or standards, regardless of any support or applications information provided by ON Semiconductor. "Typical" parameters which may be provided in ON Semiconductor data sheets and/or specifications can and do vary in different applications and actual performance may vary over time. All operating parameters, including "Typicals" must be validated for each customer application by customer's technical experts. ON Semiconductor does not convey any license under its patent rights nor the rights of others. ON Semiconductor products are not designed, intended, or authorized for use as a critical component in life support systems or any FDA Class 3 medical devices or medical devices with a same or similar classification in a foreign jurisdiction or any devices intended for implantation in the human body. Should Buyer purchase or use ON Semiconductor products for any such unintended or unauthorized application, Buyer shall indemnify and hold ON Semiconductor and its officers, employees, subsidiaries, affiliates, and distributors harmless against all claims, costs, damages, and expenses, and reasonable attorney fees arising out of, directly or indirectly, any claim of personal injury or death associated with such unintended or unauthorized use, even if such claim alleges that ON Semiconductor was negligent regarding the design or manufacture of the part. ON Semiconductor is an Equal Opportunity/Affirmative Action Employer. This literature is subject to all applicable copyright laws and is not for resale in any manner.

PUBLICATION ORDERING INFORMATION

LITERATURE FULFILLMENT:

Email Requests to: orderlit@onsemi.com

ON Semiconductor Website: www.onsemi.com

TECHNICAL SUPPORT

North American Technical Support:
Voice Mail: 1 800-282-9855 Toll Free USA/Canada
Phone: 011 421 33 790 2910

Europe, Middle East and Africa Technical Support:

Phone: 00421 33 790 2910

For additional information, please contact your local Sales Representative

Mouser Electronics

Authorized Distributor

Click to View Pricing, Inventory, Delivery & Lifecycle Information:

[ON Semiconductor:](#)

[NUF2101MT1](#) [NUF2101MT1G](#)