

# RK163 16mm Size Metal Shaft Type

A wide range of versatile products applicable for various types of control

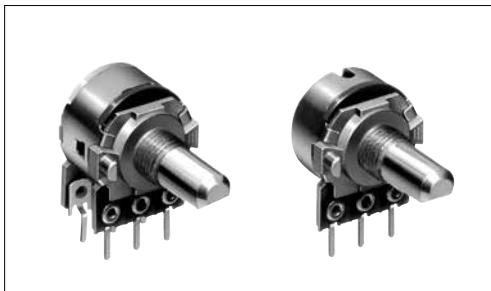

## Typical Specifications

Items	Specifications
Total resistance tolerance	±20%
Maximum operating voltage	150V AC, 5V DC
Total rotational angle	300° ±3°
Rotational torque	3 to 25mN·m
Operating life	15,000 cycles
Operating temperature range	-10°C to +70°C

## Product Line

Number of resistor elements	Mounting direction	Shaft type	Terminal style	Length of the shaft L <sub>1</sub> (mm)	Center detent	Total resistance (kΩ)	Resistance taper	Minimum order unit (pcs.)		Products No.	Drawing No.			
								Japan	Expert					
Single-unit	Horizontal type	Flat	For PC board	15	Without	10	1B	600	1,200	<b>RK1631110TBK</b>	1			
				20						<b>RK1631110TT3</b>				
			Lead	<b>RK1631110U1Q</b>										
		Serrated	For PC board	15						20	200	400	<b>RK1631110TNP</b>	2
				Lead						600	1,200	<b>RK1631110TTU</b>	3	
			Lead	200						400	<b>RK1631110U0Q</b>	4		
Dual-unit for tone	Horizontal type	Flat	For PC board	20	With	10	1B	600	1,200	<b>RK1631210AWN</b>	5			
				15	<b>RK1631210A2</b>									
Dual-unit for vol.	Horizontal type	Serrated	For PC board	15	Without	50	15A	600	1,200	<b>RK1631210AX9</b>	6			
				20						<b>RK16312A0B85</b>				
		Flat	25	3B						<b>RK16312A0BKH</b>	5			
			Serrated	15						15A	<b>RK16312A0BKR</b>	6		

### Note

Other varieties are also available. Refer to "Other Specifications" (P.327).

## Packing Specifications

Bulk







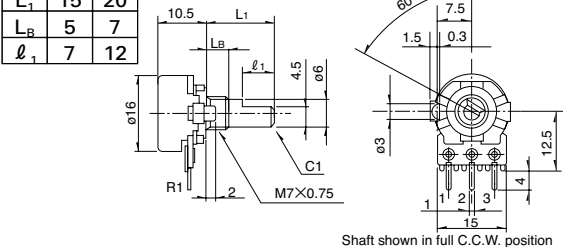
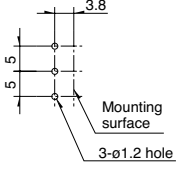

Terminal style	Number of packages (pcs.)		Export package measurements (mm)
	1 case /Japan	1 case /export packing	
<b>For PC board</b>	600	1,200	532×326×386
<b>Lead</b>	200	400	360×270×155

Refer to P.327 for other specifications.  
 Refer to P.328 for attached parts.  
 Refer to P.329 for ordering products not listed.  
 Refer to P.343 for soldering conditions

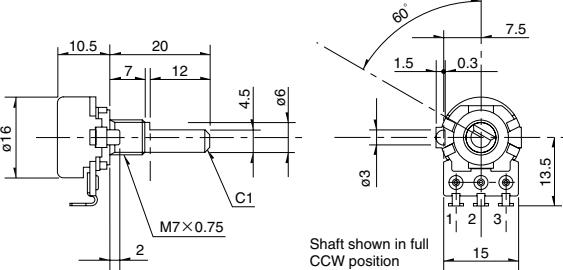
# RK163 16mm Size Metal Shaft Type

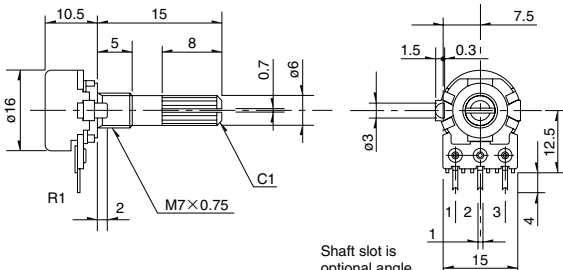
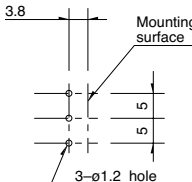
## Dimensions

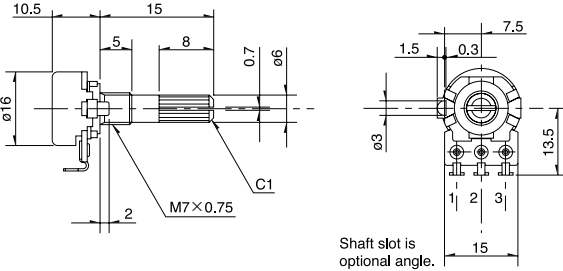
Unit:mm

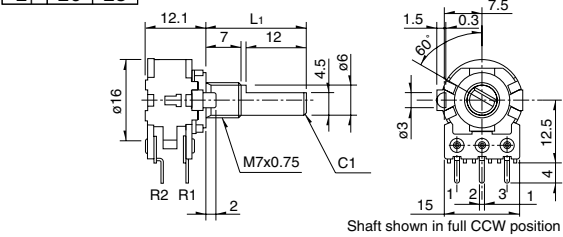
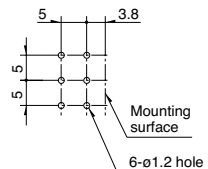
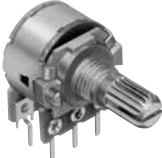
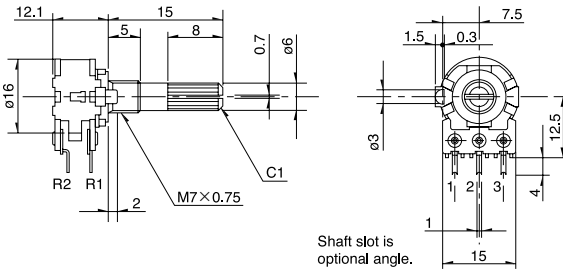
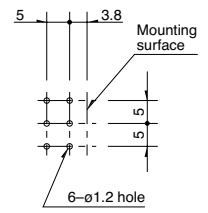
No.	Photo	Style	PC board mounting hole dimensions (Viewed from mounting side)									
1		<table border="1" data-bbox="592 353 727 443"> <tr> <td><math>L_1</math></td> <td>15</td> <td>20</td> </tr> <tr> <td><math>L_B</math></td> <td>5</td> <td>7</td> </tr> <tr> <td><math>l_1</math></td> <td>7</td> <td>12</td> </tr> </table>  <p>Shaft shown in full C.C.W. position</p>	$L_1$	15	20	$L_B$	5	7	$l_1$	7	12	
$L_1$	15	20										
$L_B$	5	7										
$l_1$	7	12										
2		 <p>Shaft shown in full CCW position</p>										
3		 <p>Shaft slot is optional angle.</p>										
4		 <p>Shaft slot is optional angle.</p>										
5		<table border="1" data-bbox="592 1507 727 1541"> <tr> <td><math>L_1</math></td> <td>20</td> <td>25</td> </tr> </table>  <p>Shaft shown in full CCW position</p>	$L_1$	20	25							
$L_1$	20	25										
6		 <p>Shaft slot is optional angle.</p>										

# 16mm Size Metal Shaft Type / Other Specifications

In addition to the products listed, we can accommodate the follow specifications.

## Product Specifications and Applications

Type	Model	Applications	Detent variety
Single-shaft, single-unit	<b>RK16311</b>	General	Center
Single-shaft, dual-unit	<b>RK16312</b>	General or Volume and tone control	

## Total Resistance Variety

Total resistance (kΩ)	5	10	20	50	100	200

## Resistance Taper

Resistance taper	15A	1B	3B	15C

## Dimensions of Shaft

### 1) 18 teeth serrated type

Unit:mm

L <sub>1</sub>	L <sub>B</sub>	l <sub>1</sub>
15	5	8
20	5	12
25	7	12
30	7	12

● The serration angle shall be as shown.

### 2) Flat type

Unit:mm

L <sub>1</sub>	L <sub>B</sub>	l <sub>1</sub>
15	5	7
20	7	12
25	7	12
30	7	12

Shaft shown in full CCW position

### 3) Slotted type

Unit:mm

L <sub>1</sub>	L <sub>B</sub>
15	7
20	7
25	7
30	7

Shaft shown in full CCW position

## Note

Marked are specifications recommended by Alps Alpine.  
Die-cast shaft is standard.

# 16mm Size Metal Shaft Type / Attached Parts

The following parts are included with the product.

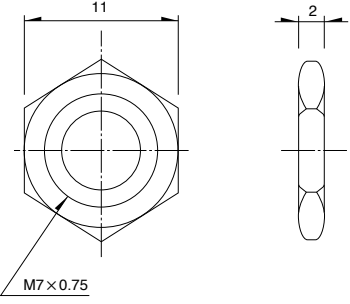
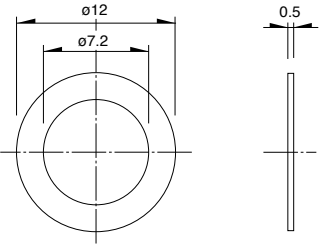
		Unit:mm	
Nut		Washer	
			

Rotary  
Potentialmeters  
Slide  
Potentialmeters

Metal  
Shaft

Insulated  
Shaft

Knob  
Operating

Through  
Shaft Type

Ring  
Type

# 16mm Size Metal Shaft Type / Ordering Products Not Listed

When ordering product varieties that are not listed, specify referring to the examples below.

## Sample Part Number

**R K 1 6 3 1 1 1 0 - F 2 0 - C 0 - B 1 0 3 - P**

### Model type

Code	Model type
111	Single-unit
121	Dual-unit for tone
12A	Dual-unit for vol.

### Shaft type

Code	Shaft type
F	Flat
S	Slotted
K	Serrated

### Length of the shaft L<sub>1</sub> (mm)

Code	Length of the shaft	Code	Length of the shaft
15	15	25	25
20	20	30	30

### Detent

Code	Detent
C0	Without
C1	Center

### Resistance taper

Code	Resistance taper	Code	Resistance taper
A	15A	V	3B
B	1B	C	15C

B: For tone & general  
(model type : 111, 121)

V: For vol. (model type : 111, 12A)

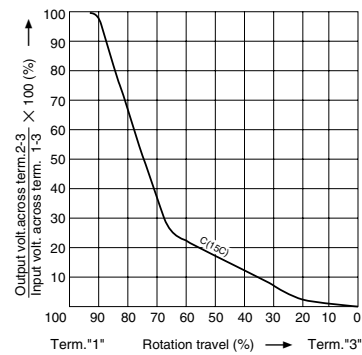
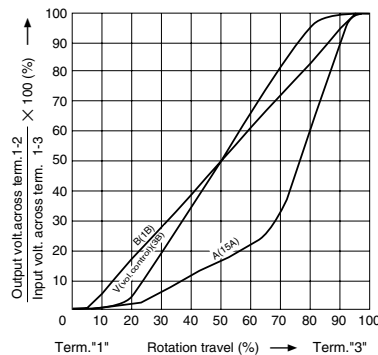

### Total resistance











Code	Total resistance (k Ω)	Code	Total resistance (k Ω)
502	5	503	50
103	10	104	100
203	20	204	200

### Terminal Style

Code	Terminal style
P	For PC board
L	Lead terminal

### Note

Marked are specifications recommended by Alps Alpine.

Type	16mm size	20mm size	27mm size	50mm size	Rotary motor-driven	
Series	<b>RK163</b>	<b>RK203</b>	<b>RK271</b>	<b>RK501</b>	<b>RK168</b>	
	Single-shaft					
Number of resistor elements	Single/dual	Single	Single/dual/quad	Dual/quad	Dual/quad/5-ganged/6-ganged	
Photo						
Terminal mounting	Horizontal	Vertical	Horizontal			
Fixing method of bushing	Bushing screw clamp					
Operating temperature range	-10°C to +70°C	-40°C to +85°C	-10°C to +70°C			
Operating life	15,000 cycles	30,000 cycles	15,000 cycles			
Available for automotive use	—	○	—	—	—	
Life cycle (availability)						
Electrical performance	Total resistance (k Ω)	5, 10, 20, 50, 100, 200	10	5, 10, 20, 50, 100, 250	10, 20, 50, 100	
	Resistance taper	15A, 1B, 3B, 15C	B	15A, 3B		
	Rated Power	0.1W 0.05W (15A)	0.05W		0.1W	0.05W
	Residual resistance	R ≤ 10kΩ 20Ω max. 10kΩ < R ≤ 50kΩ 30Ω max. 50kΩ < R < 3MΩ Nominal total resistance of 0.1% or less%	—	R ≤ 10kΩ 20Ω max. 10kΩ < R < 50kΩ 30Ω max. 50kΩ ≤ R Nominal total resistance of 0.1% or less%	—	—
	Maximum attenuation (Volume control)	5kΩ ≤ R < 10kΩ 70dB min. 10kΩ ≤ R < 50kΩ 80dB min. 50kΩ ≤ R < 100kΩ 90dB min. 100kΩ ≤ R 100dB min.	—	5kΩ ≤ R < 10kΩ 70dB min. 10kΩ ≤ R < 50kΩ 80dB min. 50kΩ ≤ R < 100kΩ 90dB min. 100kΩ ≤ R 100dB min.	120dB min.	5kΩ ≤ R < 10kΩ 70dB min. 10kΩ ≤ R < 50kΩ 80dB min. 50kΩ ≤ R < 100kΩ 90dB min. 100kΩ ≤ R 100dB min.
	Gang error applicable to Dual-unit parts for audio volume control purposes	-40dB to 0dB 3dB max.	—	-70dB to -60dB 3dB max. -60dB to 0dB 2dB max.	-100dB to 0dB 2dB max.	-60dB to -40dB 5dB max. -40dB to 0dB 3dB max.
	Insulation resistance	100MΩ min. 500V DC	10MΩ min. 250V DC	100MΩ min. 500V DC		100MΩ min. 250V DC
	Voltage proof	500V AC for 1minute	300V AC for 1minute	500V AC for 1minute		300V AC for 1minute
	Center-taps	Without				
Mechanical performance	Detent	Without, Cente	17	Without, Center, 21, 31, 41	Without	
	Stopper strength	0.9 N·m	0.5 N·m	0.9 N·m	1.5 N·m 0.9 N·m	
	Push-pull strength	100N max.		150N max.	100N max.	
	Vibration	10 to 55 to 10Hz/min., the amplitude is 1.5mm for all the frequencies, in the 3 direction of X, Y and Z for 2 hours respectively				
Shaft style	Serrated type, Flat type, Slotted type	Flat type	Slotted type, Flat type	Slotted type	Flat type	
Terminal style	Insertion, Lead	Insertion				
Attached switch	—	—	—	—	—	
Page	325	330	333	337	339	

Metal Shaft Potentiometers Soldering Conditions	343
Potentiometers Cautions	418
Potentiometers Measurement and Test Methods	420
Potentiometers Resistance Taper	422

**Note**

○ Indicates applicability to some products in the series.

## Reference for Manual Soldering

Series	Tip temperature	Soldering time	No. of solders
<b>RK09L, RK097</b>	350°C max.	3s max.	1 time
<b>RK203</b>	300°C max.	3s max.	1 time
<b>RK119</b>	350±10°C	3 <sup>+1</sup> <sub>0</sub> s	1 time
<b>RK271</b>	350°C max.	5s max.	1 time
<b>RK501</b>	350±10°C	5 <sup>+1</sup> <sub>0</sub> s	1 time
<b>RK163</b>	350°C max.	5s max.	1 time
<b>RK168</b>	<b>Potentiometer terminal</b>	300°C max.	3s max.
	<b>Motor terminal</b>	350°C max.	2s max.

## Reference for Dip Soldering

Series	Preheating		Dip soldering		No. of solders
	Soldering surface temperature	Heating time	Soldering temperature	Soldering time	
<b>RK09L, RK097, RK203</b>	100°C max.	2 min. max.	260±5°C	5±1s	2 time max.
<b>RK501</b>	120±10°C	2 min. max.	260±5°C	5±1s	2 time

## Example of Reflow Soldering Condition

Temperature profile

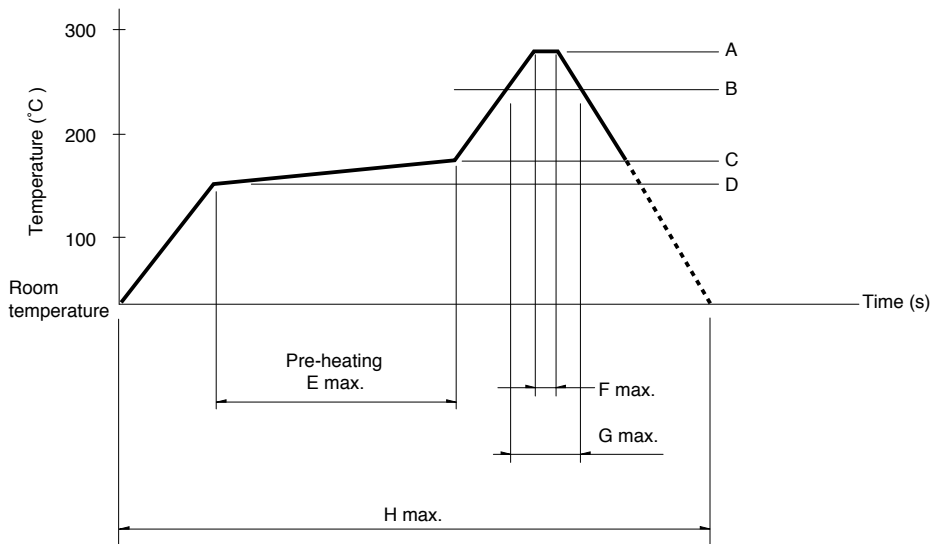

Series	A	B	C	D	E	F	G	H	No. of reflows
<b>RK119</b>	260°C	230°C	180°C	150°C	2 min.	3s	40s	4 min.	2 time max.

## Notes

1. When using an infrared reflow oven, solder may sometimes not be applied. Be sure to use a hot air reflow oven or at type that uses infrared rays in combination with hot air.
2. The temperatures given above are the maximum temperatures at the terminals of the potentiometer when employing a hot air reflow method. The temperature of the PC board and the surface temperature of the potentiometer may vary greatly depending on the PC board material, its size and thickness. Ensure that the surface temperature of the potentiometer does not rise to 250°C or greater.
3. Conditions vary to some extent depending on the type of reflow bath used. Be sure to give due consideration to this prior to use.