

PRELIMINARY

背景
BACK GROUND
SCDG1A0109
Correction
Design change:
Taping spec.

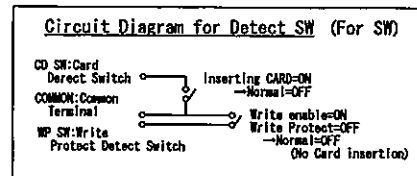
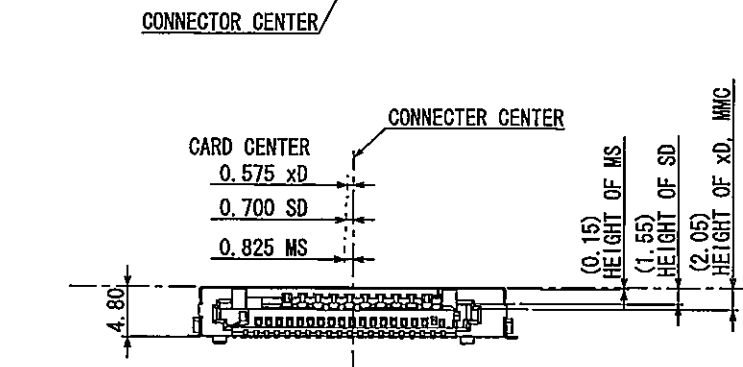
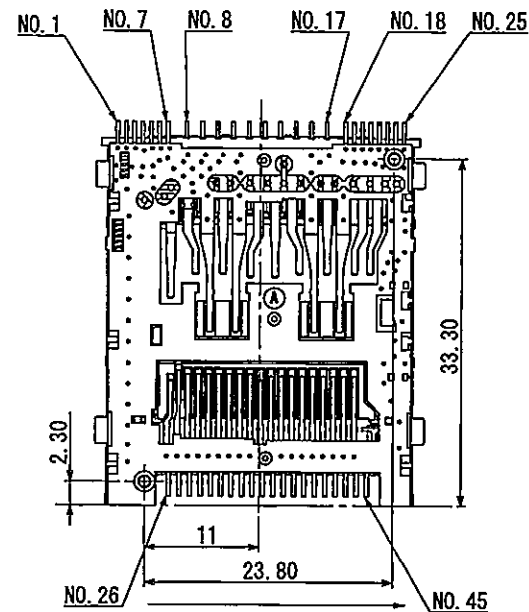
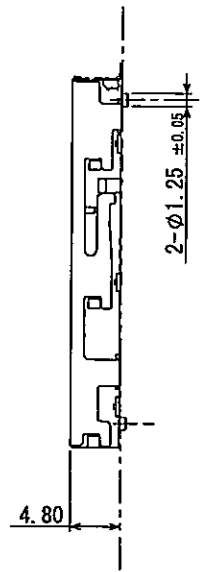
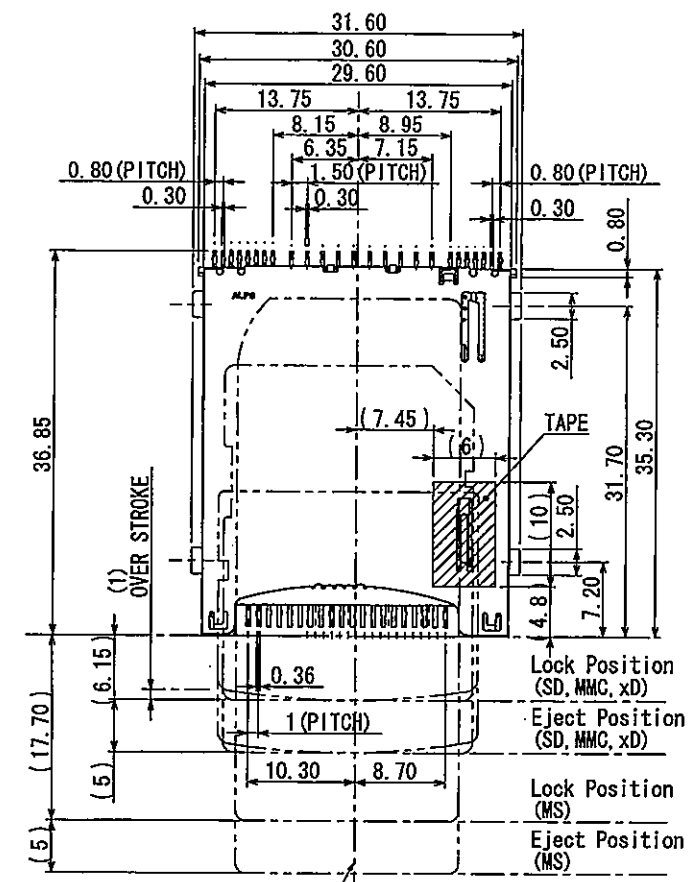

Number	FOR	Pin assign	Function
1	SD	#9	SD-DAT2
2	SD	#1	SD-CD/DAT3
3	MMC Plus	#10	MMC-DAT4
4	SD	#2	SD-CMD
5	MMC Plus	#11	MMC-DAT5
6	SD	#3	SD-VSS
7	SD	#4	SD-VDD
8	MemoryStick	#10	MS-VSS
9	MemoryStick	#9	MS-VCC
10	MemoryStick	#8	MS-SCLK
11	MemoryStick	#7	MS-DATA3
12	MemoryStick	#8	MS-INS
13	MemoryStick	#5	MS-DATA2
14	MemoryStick	#4	MS-DATA0
15	MemoryStick	#3	MS-DATA1
16	MemoryStick	#2	MS-BS
17	MemoryStick	#1	MS-VSS
18	SD	#5	SD-CLK
19	MMC Plus	#12	MMC-DAT6
20	SD	#6	SD-VSS
21	MMC Plus	#13	MMC-DAT7
22	SD	#7	SD-DAT0
23	SD	#8	SD-DAT1
24	SD	SW.COM	SD-COM(SW)
25	SD	SW.CD	SD-CD(SW)
26	XD	#1	XD-GND
27	XD	#0 (CD)	XD-CD
28	XD	#2	XD-R/-B
29	XD	#3	XD-RE
30	XD	#4	XD-CE
31	XD	#5	XD-CLE
32	XD	#6	XD-ALE
33	XD	#7	XD-WE
34	XD	#8	XD-WP
35	XD	#9	XD-GND
36	XD	#10	XD-D0
37	XD	#11	XD-D1
38	XD	#12	XD-D2
39	XD	#13	XD-D3
40	XD	#14	XD-D4
41	XD	#15	XD-D5
42	XD	#16	XD-D6
43	XD	#17	XD-D7
44	XD	#18	XD-VCC
45	SD	SW.WP	SD-WP(SW)

FOR SD, MMC, MMC Plus, MS (full size), xD
STANDARD MOUNT TYPE
PUSH PUSH EJECT TYPE
HALOGEN FREE

TOLERANCES UNLESS OTHERWISE SPEC.	
BASIC DIMENSION	TOLERANCE
UP TO 10	±0.3
ABOVE 10 TO 100	±0.5
ANGULAR DIMENSION	±3°

ALPS ELECTRIC CO., LTD.

DSGD, Dec. 07, 2010 Y. Arimori	SCALE 2:1	NO. SCDG1A0109
CHKD, Dec. 07, 2010 H. Sasaki	TITLE PRODUCT DRAWING (製品図) (1/3)	
APPLD, Dec. 07, 2010 Y. Okabe	UNIT mm	DOCUMENT NO. SCDG1A0109, AE13, 023

SYMB	DATE	APPD	CHKD	DSGD
△4	May. 17, 2011	H.S.	H.S.	Y.A.
△2	Jan. 25, 2011	Y.O.	H.S.	Y.A.

PRELIMINARY

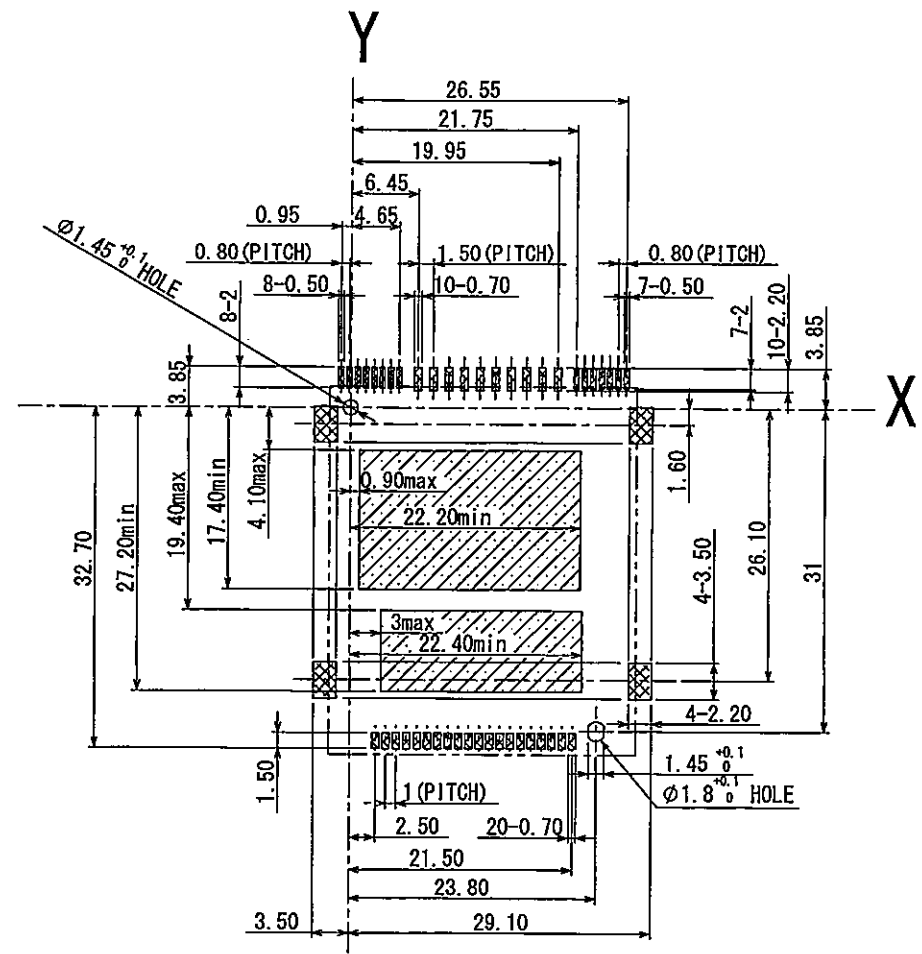

 LAND AREA
  NO PATTERN AREA

Recommended P.C. Board layout (Mounting face side)
 TOLERANCES UNLESS OTHERWISE SPEC. ±0.05

					ALPS ELECTRIC CO., LTD.		
		DSGD. Dec. 07. 2010 Y. Arimori	SCALE 2:1			NO. SCDG1A0109	
		CHKD. Dec. 07. 2010 H. Sasaki				TITLE PRODUCT DRAWING (製品図) (2/3)	
		APPD. Dec. 07. 2010 Y. Okabe	UNIT mm			DOCUMENT NO. SCDG1A0109, AE23, 023	
SYMB	DATE	APPD	CHKD	DSGD			

引き出し方向
PULL OUT DIRECTION

CARRIER TAPE (2:1)

PRELIMINARY

△ DESIGN CHANGE
REEL CORE (1:10)

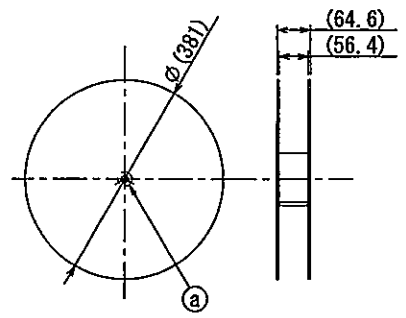

△ DESIGN CHANGE

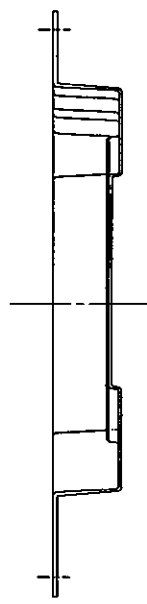
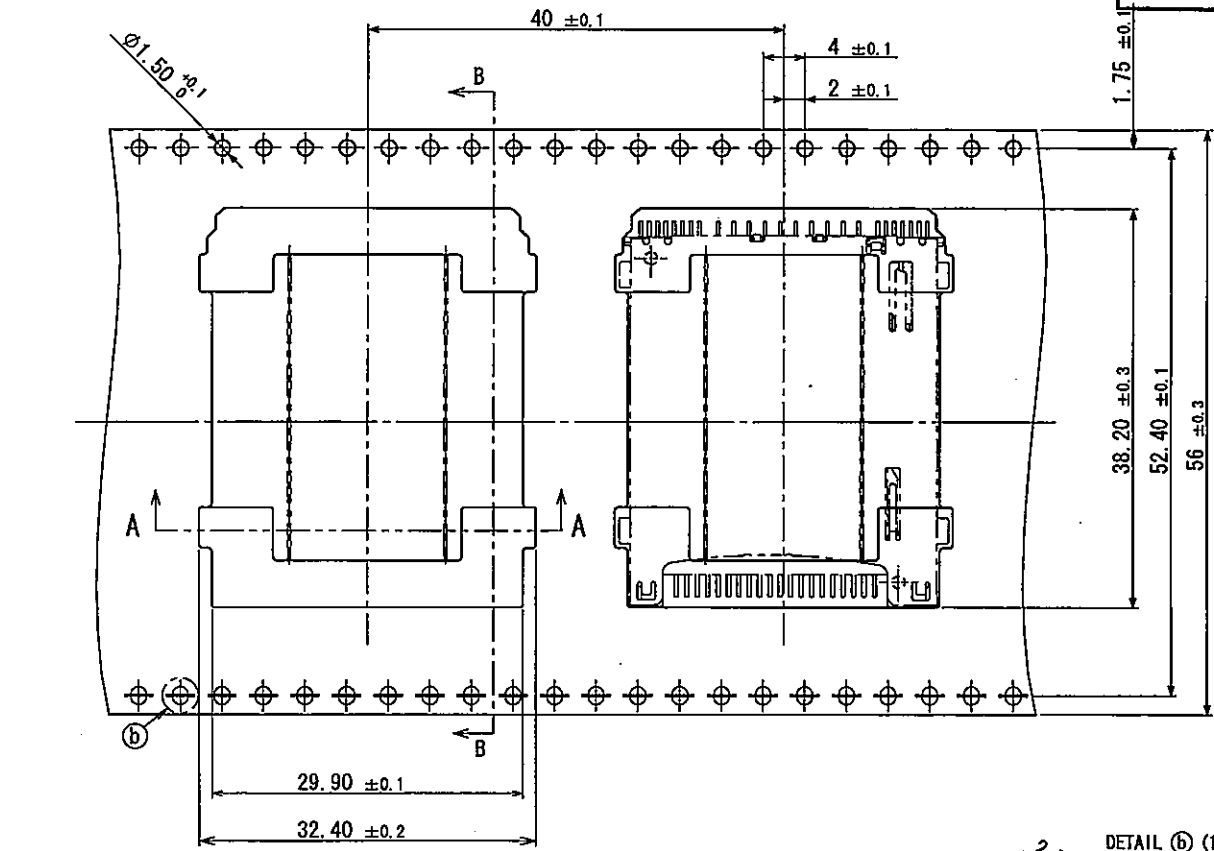
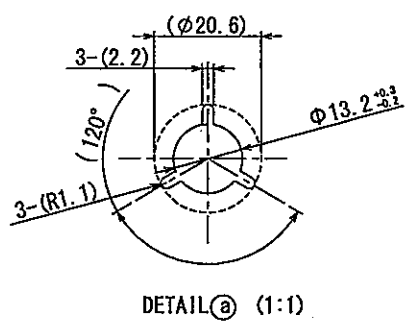

SECTION B-B

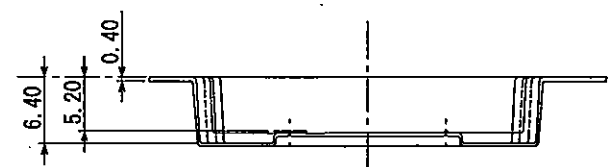

SECTION A-A

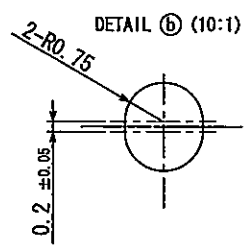

ALPS ELECTRIC CO., LTD.

DSGD. Dec. 07. 2010 Y. Arimori	SCALE 2:1	NO. SCDG1A0109
CHD. Dec. 07. 2010 H. Sasaki		TITLE PRODUCT DRAWING (製品図) (3/3)
APPD. Dec. 07. 2010 Y. Okabe	UNIT mm	DOCUMENT NO. SCDG1A0109, AE33, 023

2. 200 300PIECES / REEL
NOTE 1. SPECIFICATION OF TAPING : TAPE-S-051

SYMB	DATE	APPD	CHD	DSGD