

Enclosure series inoCASE

Type: IC 300

Material-No.: 173.300.000

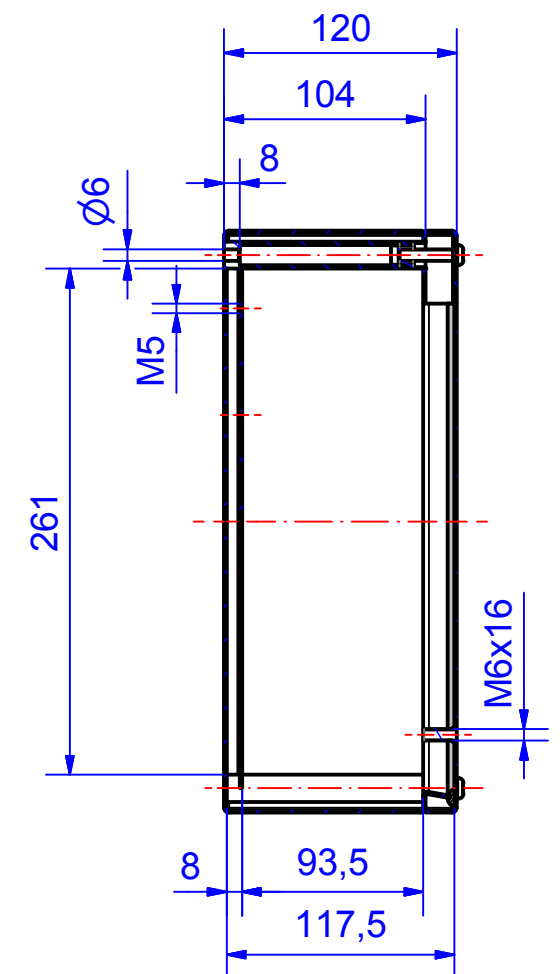
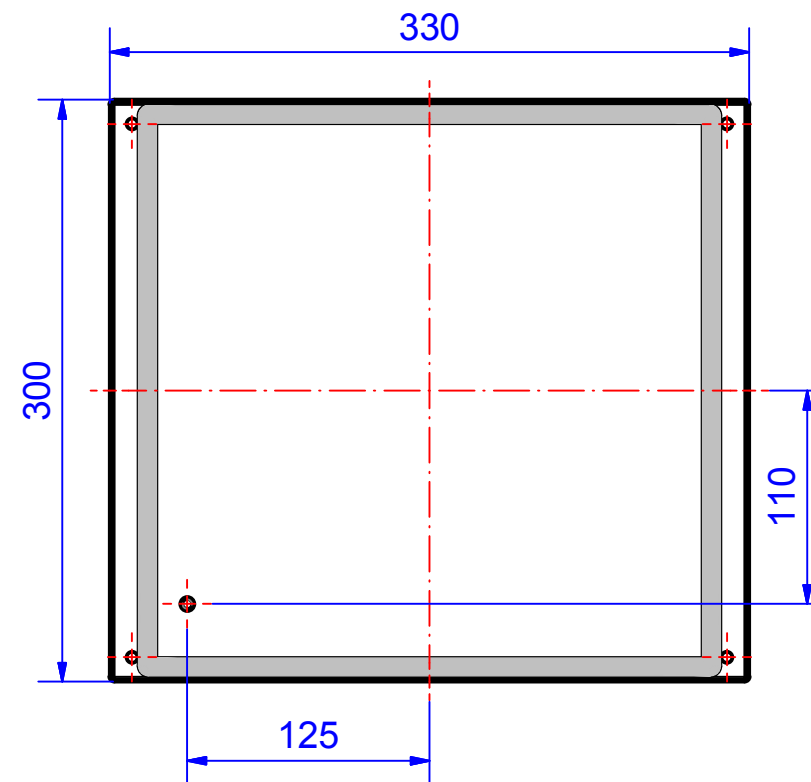
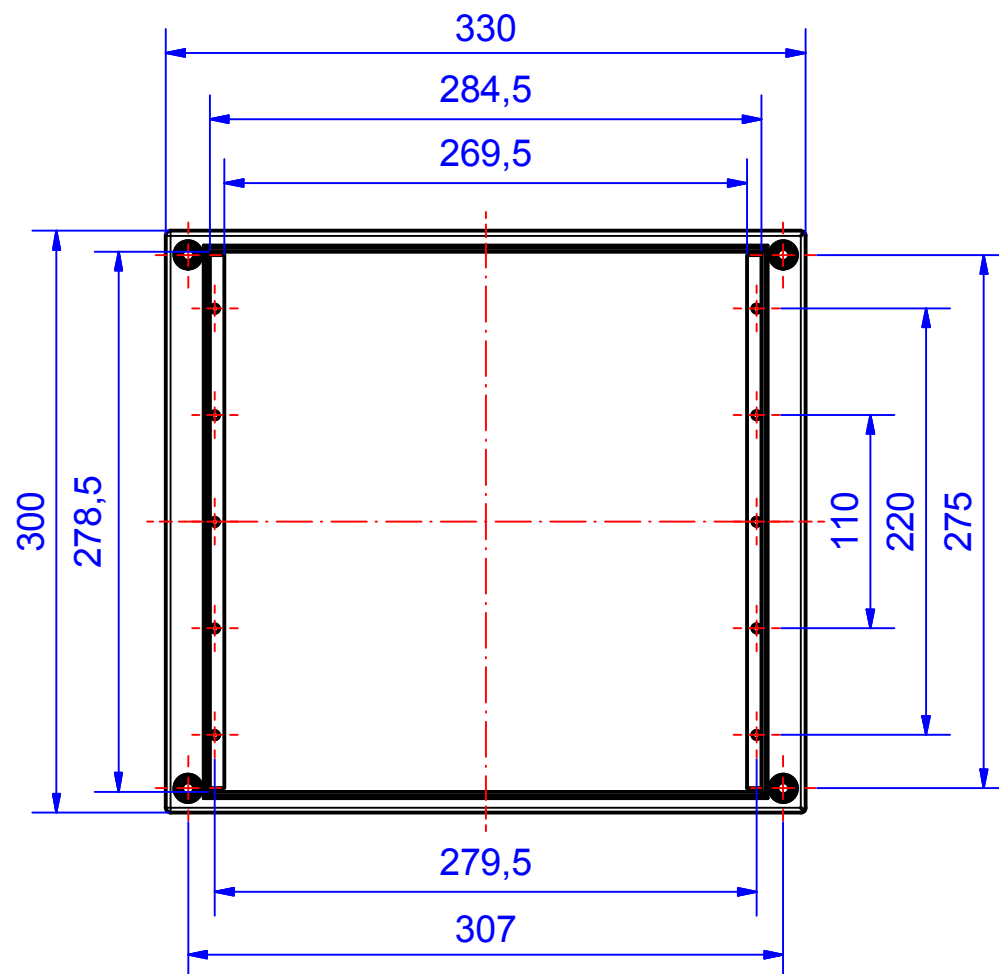

Enclosure material	V2A, 1.4301 (AISI 304)		Weight	4.829 g
Lid screws	4x V4A, captive		Sheet thickness	1,25 mm
Gasket	1x dosed gasket, silicone, grey		Surface	Grinded, grain size 320
Ingress protection	IP66 EN 60529		Tolerance	DIN ISO 2768-m DIN 6935