



# Single USB Switch with Autoreset and Fault Blanking in Tiny TDFN

MAX1946

## General Description

The MAX1946 single current-limited switch with autoreset supplies a guaranteed 500mA load in accordance with USB specifications. The MAX1946 operates from a 2.7V to 5.5V input supply and consumes only 40 $\mu$ A of quiescent current when operating and only 3 $\mu$ A in shutdown. Selectable active-high/active-low control logic and shutdown control provide additional flexibility. An autoreset feature latches the switch off in the event of a short circuit, saving system power. The switch reactivates upon removal of the shorted condition.

The MAX1946 provides several safety features to protect the USB port. Built-in thermal-overload protection turns off the switch when the die temperature exceeds +160°C. Accurate internal current-limiting circuitry protects the input supply against both overload and short-circuit conditions. An open-drain fault signal, (FAULT), notifies the microprocessor ( $\mu$ P) when a thermal overload, current-limit, undervoltage lockout (UVLO), or short-circuit fault occurs. A 20ms fault-blanking feature enables the circuit to ignore momentary faults, such as those caused when hot-swapping a capacitive load, preventing false alarms to the host system. The fault-blanking feature prevents fault signals from being issued when the device powers up the load.

The MAX1946 is available in a space-saving 8-pin (3mm x 3mm) TDFN package and operates over the extended (-40°C to +85°C) temperature range.

## Applications

USB Ports and USB Hubs  
 Notebook and Desktop Computers  
 PDAs and Palmtop Computers  
 Digital Cameras  
 Docking Stations

## Pin Configuration

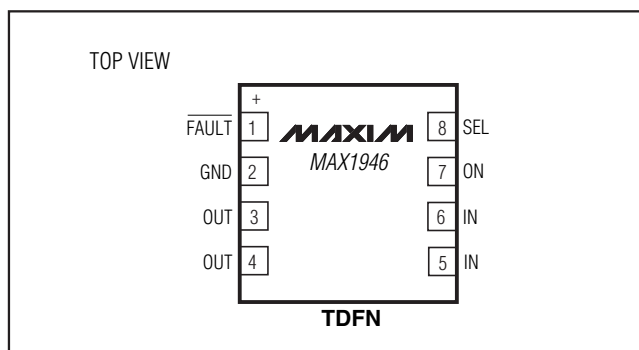

## Features

- ◆ Single USB Switch in 3mm x 3mm Package
- ◆ Autoreset Feature Saves System Power
- ◆ Guaranteed 500mA Load Current
- ◆ Built-In 20ms Fault-Blanking Circuitry
- ◆ Active-High or Active-Low Control Logic
- ◆ Fully Compliant to USB Specifications
- ◆ 2.7V to 5.5V Input Voltage Range
- ◆ Fault-Indicator Output
- ◆ Thermal-Overload Protection

## Ordering Information

PART	TEMP RANGE	PIN-PACKAGE	TOP MARK
MAX1946ETA+	-40°C to +85°C	8 TDFN-EP*	ACQ

+Denotes a lead(Pb)-free/RoHS-compliant package.  
 \*EP = Exposed paddle.

## Typical Operating Circuit

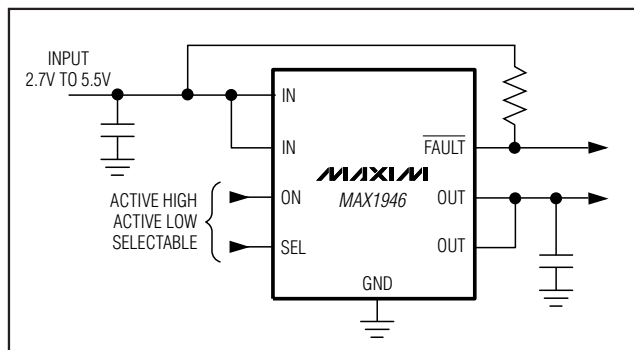

# Single USB Switch with Autoreset and Fault Blanking in Tiny TDFN

## ABSOLUTE MAXIMUM RATINGS

IN, ON, OUT, SEL to GND.....	-0.3V to +6V
FAULT to GND.....	-0.3V to (V <sub>IN</sub> + 0.3V)
IN to OUT.....	-0.3V to +6V
OUT Continuous Switch Current (internally limited).....	1.3A
FAULT DC Current.....	10mA

Continuous Power Dissipation (T <sub>A</sub> = +70°C)	
Exposed Pad Must be Soldered to PC Board	
8-Pin TDFN (derate 23.8mW/°C above +70°C) .....	1905mW
Operating Temperature Range .....	-40°C to +85°C
Junction Temperature.....	+150°C
Storage Temperature Range .....	-65°C to +150°C
Lead Temperature (soldering, 10s) .....	+300°C

Stresses beyond those listed under "Absolute Maximum Ratings" may cause permanent damage to the device. These are stress ratings only, and functional operation of the device at these or any other conditions beyond those indicated in the operational sections of the specifications is not implied. Exposure to absolute maximum rating conditions for extended periods may affect device reliability.

## ELECTRICAL CHARACTERISTICS

(V<sub>IN</sub> = 5V, C<sub>IN</sub> = 0.1µF, C<sub>OUT</sub> = 1µF, T<sub>A</sub> = 0°C to +85°C, unless otherwise noted. Typical values are at T<sub>A</sub> = +25°C.) (Note1)

PARAMETER	SYMBOL	CONDITIONS	MIN	TYP	MAX	UNITS
Supply Voltage Range	V <sub>IN</sub>		2.7		5.5	V
Switch On-Resistance	R <sub>ON</sub>	V <sub>IN</sub> = 5, T <sub>A</sub> = +25°C		75	90	mΩ
		V <sub>IN</sub> = 5V			110	
		V <sub>IN</sub> = 3.3V			125	
Standby Supply Current		Switch disabled		3	10	µA
Quiescent Supply Current	I <sub>IN</sub>	Switch enabled, I <sub>OUT</sub> = 0		40	60	µA
OUT Off-Leakage Current	I <sub>LKG</sub>	Switch disabled, V <sub>OUT</sub> = 0, T <sub>A</sub> = +25°C		0.01	1	µA
		Switch disabled, V <sub>OUT</sub> = 0, T <sub>A</sub> = +85°C		0.2		
Undervoltage Lockout Threshold	V <sub>ULVO</sub>	Rising edge, 3% hysteresis	2.3	2.5	2.7	V
Continuous Load Current			500			mA
Continuous Current Limit	I <sub>LIM</sub>	V <sub>IN</sub> - V <sub>OUT</sub> = 0.5V	0.74	1.1	1.20	A
Short-Circuit Current Limit	I <sub>SC</sub>	V <sub>OUT</sub> = 0 (I <sub>OUT</sub> pulsing)	0.8	1.2	1.6	A <sub>PK</sub>
				0.35		A <sub>RMS</sub>
Short-Circuit Detect Threshold		(Note 2)		1		V
Continuous Current-Limit Blanking Timeout Period		From continuous current-limit condition to $\overline{\text{FAULT}}$ asserted	10	20	35	ms
Short-Circuit Blanking Timeout Period		From short-circuit current-limit condition to $\overline{\text{FAULT}}$ asserted	7.5	18	35.0	ms
Turn-On Delay	t <sub>ON</sub>	R <sub>OUT</sub> = 10Ω, time from ON to 10% of V <sub>OUT</sub> , does not include rise time	0.25	0.6	1.50	ms
Output Rise Time	t <sub>RISE</sub>	R <sub>OUT</sub> = 10Ω, from 10% to 90% of V <sub>OUT</sub>		1.2		ms
Turn-Off Delay	t <sub>OFF</sub>	R <sub>OUT</sub> = 10Ω, time from ON to 90% of V <sub>OUT</sub> , does not include fall time		0.8	2	ms
Output Fall Time	t <sub>FALL</sub>	R <sub>OUT</sub> = 10Ω, from 90% to 10% of V <sub>OUT</sub>		3		ms
Thermal-Shutdown Threshold		15°C hysteresis		160		°C

# Single USB Switch with Autoreset and Fault Blanking in Tiny TDFN

MAX1946

## ELECTRICAL CHARACTERISTICS (continued)

( $V_{IN} = 5V$ ,  $C_{IN} = 0.1\mu F$ ,  $C_{OUT} = 1\mu F$ ,  $T_A = 0^\circ C$  to  $+85^\circ C$ , unless otherwise noted. Typical values are at  $T_A = +25^\circ C$ .) (Note1)

PARAMETER	SYMBOL	CONDITIONS	MIN	TYP	MAX	UNITS
ON, SEL Input High Level	$V_{IH}$	$V_{IN} = 2.7V$ to $4V$	1.6			V
		$V_{IN} = 4V$ to $5.5V$	2			
ON, SEL Input Low Level	$V_{IL}$	$V_{IN} = 2.7V$ to $4V$			0.6	V
		$V_{IN} = 4V$ to $5.5V$			0.8	
ON, SEL Input Leakage Current		$V_{ON}$ , $V_{SEL} = 0$ or $V_{IN}$ , $T_A = +25^\circ C$	-1		+1	$\mu A$
FAULT Output Low Voltage	$V_{OL}$	$I_{SINK} = 1mA$ , $V_{IN} = 2.7V$			0.5	V
FAULT Output High Leakage Current		$V_{IN} = V_{FAULT} = 5.5V$		1		$\mu A$
OUT Output Current Autoreset Mode		In latched off state, $V_{OUT} = 0$	10	25	45	mA
OUT Autoreset Threshold		In latched off state, $V_{OUT}$ rising	0.4	0.5	0.6	V
OUT Autoreset Blanking Time		In latched off state, $V_{OUT} > 0.5V$	10	20	35	ms

## ELECTRICAL CHARACTERISTICS

( $V_{IN} = 5V$ ,  $C_{IN} = 0.1\mu F$ ,  $C_{OUT} = 1\mu F$ ,  $T_A = -40^\circ C$  to  $+85^\circ C$ , unless otherwise noted.) (Note1)

PARAMETER	SYMBOL	CONDITIONS	MIN	TYP	MAX	UNITS
Supply Voltage Range	$V_{IN}$		2.7		5.5	V
Switch On-Resistance	$R_{ON}$	$V_{IN} = 5$ , $T_A = +25^\circ C$			90	$m\Omega$
		$V_{IN} = 5V$			110	
		$V_{IN} = 3.3V$			125	
Standby Supply Current		Switch disabled			10	$\mu A$
Quiescent Supply Current	$I_{IN}$	Switch enabled, $I_{OUT} = 0$			60	$\mu A$
OUT Off-Leakage Current	$I_{LKG}$	Switch disabled, $V_{OUT} = 0$ , $T_A = -40^\circ C$ to $+25^\circ C$			1	$\mu A$
Undervoltage Lockout Threshold	$V_{ULVO}$	Rising edge, 3% hysteresis	2.3		2.7	V
Continuous Load Current			500			mA
Continuous Current Limit	$I_{LIM}$	$V_{IN} - V_{OUT} = 0.5V$	0.6		1.3	A
Short-Circuit Current Limit	$I_{SC}$	$V_{OUT} = 0$ ( $I_{OUT}$ pulsing)	0.8		1.6	APK
Continuous Current-Limit Blanking Timeout Period		From continuous current-limit condition to FAULT asserted	10		35	ms
Short-Circuit Blanking Timeout Period		From short-circuit current-limit condition to FAULT asserted	7.5		35.0	ms
Turn-On Delay	$t_{ON}$	$R_{OUT} = 10\Omega$ . Time from ON to 10% of $V_{OUT}$ . Does not include rise time.	0.25		1.50	ms

# Single USB Switch with Autoreset and Fault Blanking in Tiny TDFN

## ELECTRICAL CHARACTERISTICS (continued)

( $V_{IN} = 5V$ ,  $C_{IN} = 0.1\mu F$ ,  $C_{OUT} = 1\mu F$ ,  $T_A = -40^\circ C$  to  $+85^\circ C$ , unless otherwise noted.) (Note1)

PARAMETER	SYMBOL	CONDITIONS	MIN	TYP	MAX	UNITS
Turn-Off Delay	$t_{OFF}$	$R_{OUT} = 10\Omega$ , time from ON to 90% of $V_{OUT}$ , does not include fall time			2	ms
ON, SEL Input High Level	$V_{IH}$	$V_{IN} = 2.7V$ to $4V$	1.6			V
		$V_{IN} = 4V$ to $5.5V$	2			V
ON, SEL Input Low Level	$V_{IL}$	$V_{IN} = 2.7V$ to $4V$			0.6	V
		$V_{IN} = 4V$ to $5.5V$			0.8	V
ON, SEL Input Leakage Current		$V_{ON}$ , $V_{SEL} = 0$ or $V_{IN}$	-1		+1	$\mu A$
FAULT Output Low Voltage	$V_{OL}$	$I_{SINK} = 1mA$ , $V_{IN} = 2.7V$			0.5	V
OUT Output Current Autoreset Mode		In latched off state, $V_{OUT} = 0$	10		45	mA
OUT Autoreset Threshold		In latched off state, $V_{OUT}$ rising	0.4		0.6	V
OUT Autoreset Blanking Time		In latched off state, $V_{OUT} > 0.5V$	10		35	ms

**Note 1:** All parts are 100% tested at  $T_A = +25^\circ C$ . Limits over the operating temperature range are guaranteed by design.

**Note 2:** Short-circuit detect threshold is the output voltage at which the device transitions from short-circuit current limit to continuous current limit.

## Typical Operating Characteristics

(Circuit of Figure 2,  $V_{IN} = 5V$ ,  $C_{IN} = 0.1\mu F$ ,  $C_{OUT} = 1\mu F$ , ON = SEL,  $T_A = +25^\circ C$ , unless otherwise noted.)

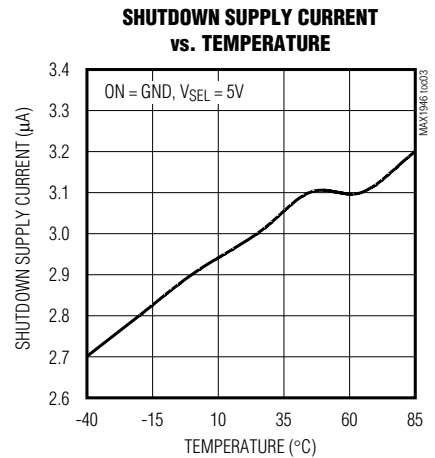
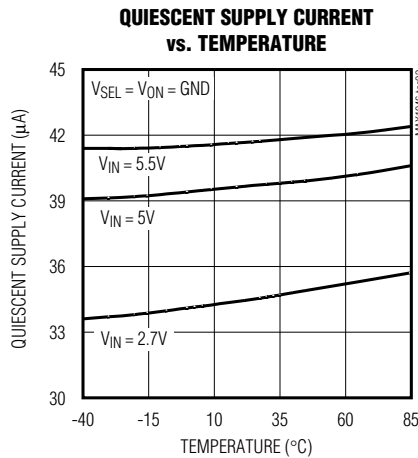
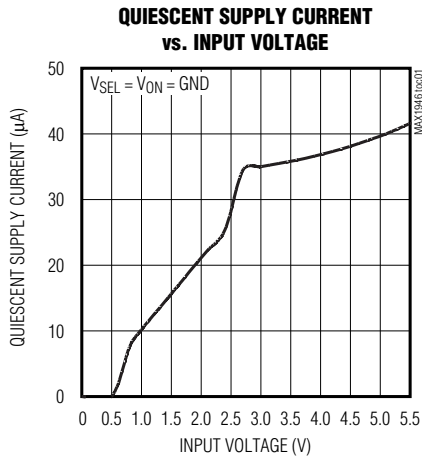

# Single USB Switch with Autoreset and Fault Blanking in Tiny TDFN

MAX1946

## Typical Operating Characteristics (continued)

(Circuit of Figure 2,  $V_{IN} = 5V$ ,  $C_{IN} = 0.1\mu F$ ,  $C_{OUT} = 1\mu F$ ,  $ON = SEL$ ,  $T_A = +25^\circ C$ , unless otherwise noted.)

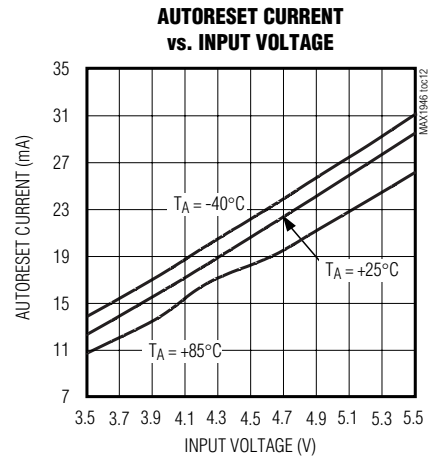
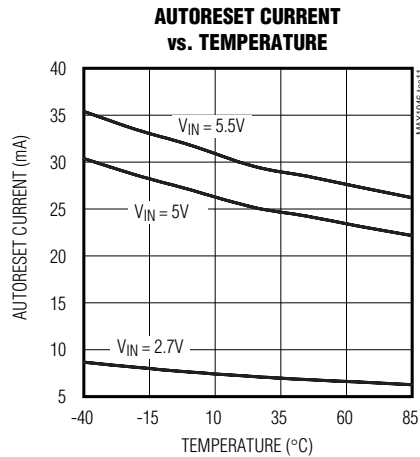
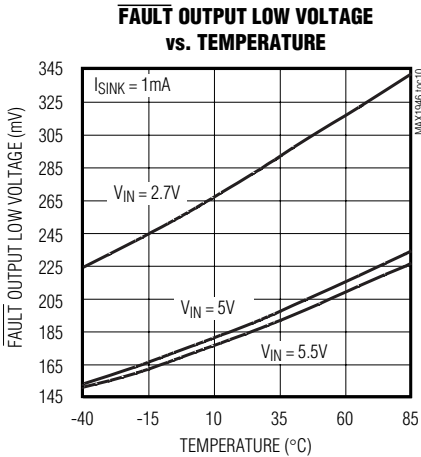
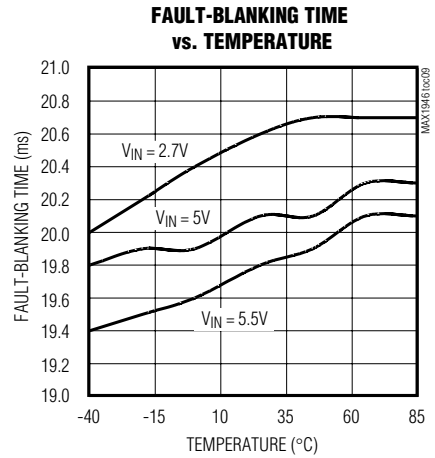
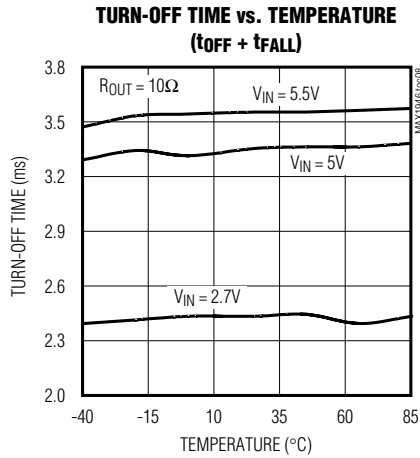
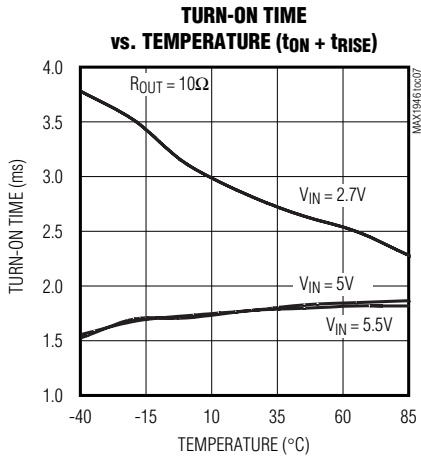
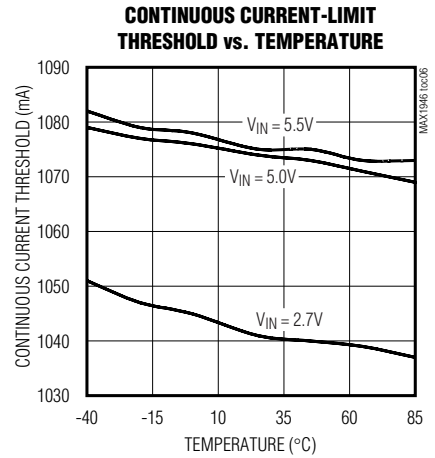
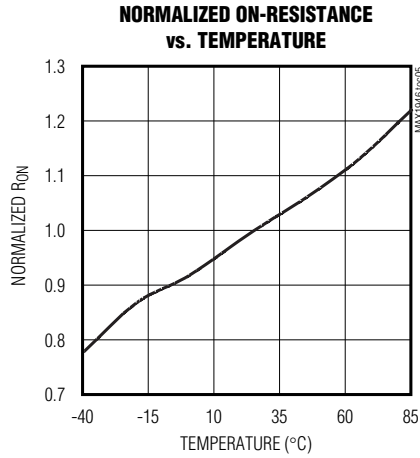
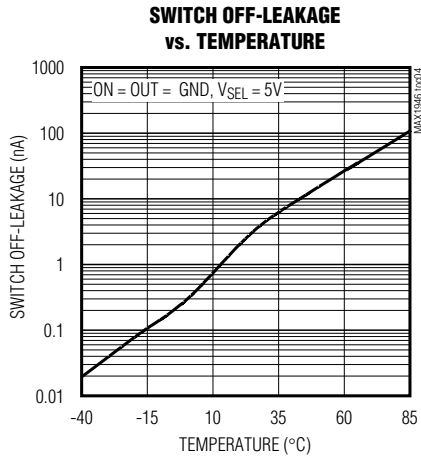

# Single USB Switch with Autoreset and Fault Blanking in Tiny TDFN

## Typical Operating Characteristics (continued)

(Circuit of Figure 2,  $V_{IN} = 5V$ ,  $C_{IN} = 0.1\mu F$ ,  $C_{OUT} = 1\mu F$ , ON = SEL,  $T_A = +25^\circ C$ , unless otherwise noted.)

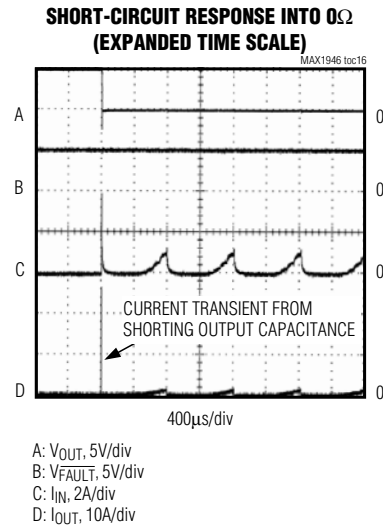
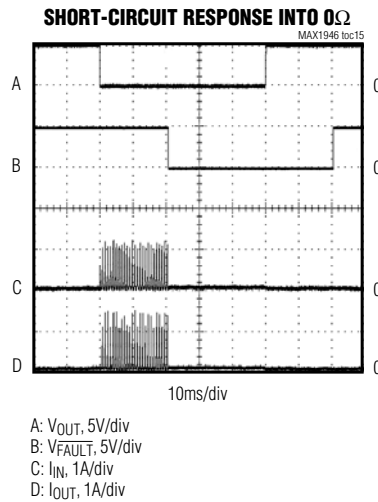
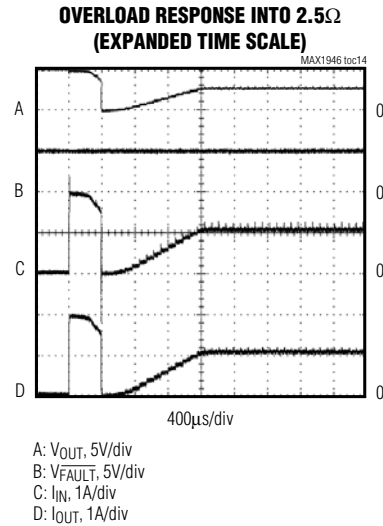
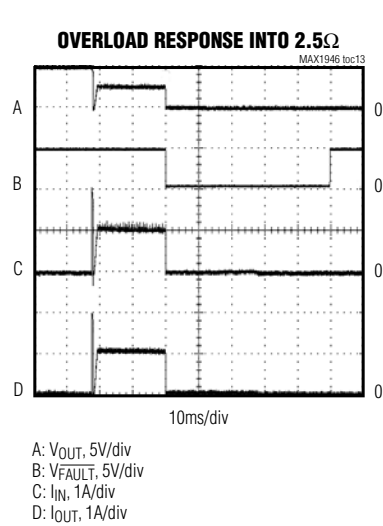

# Single USB Switch with Autoreset and Fault Blanking in Tiny TDFN

MAX1946

## Typical Operating Characteristics (continued)

(Circuit of Figure 2,  $V_{IN} = 5V$ ,  $C_{IN} = 0.1\mu F$ ,  $C_{OUT} = 1\mu F$ ,  $ON = SEL$ ,  $T_A = +25^\circ C$ , unless otherwise noted.)

**SWITCH TURN-ON TIME  
( $t_{ON} + t_{RISE}$ )**

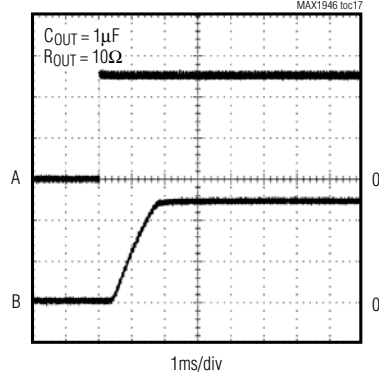

**SWITCH TURN-OFF TIME  
( $t_{OFF} + t_{FALL}$ )**

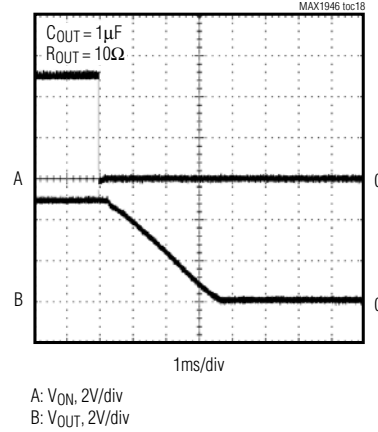

**STARTUP WAVEFORMS  
 $C_{OUT} = 1\mu F$**

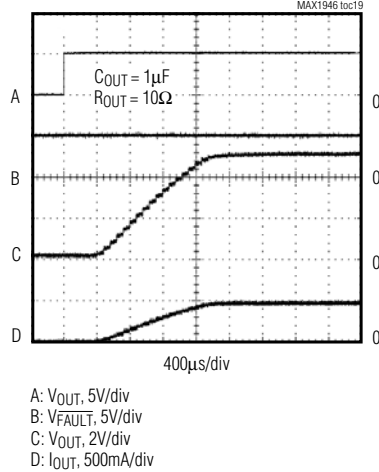

**STARTUP WAVEFORMS  
 $C_{OUT} = 330\mu F$**

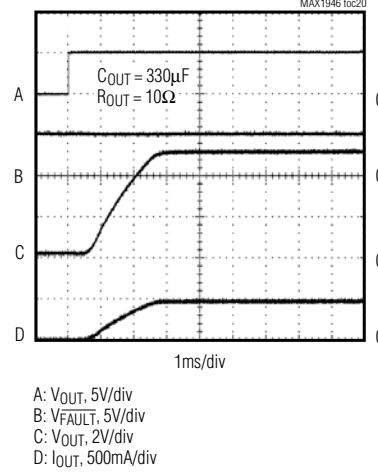

# Single USB Switch with Autoreset and Fault Blanking in Tiny TDFN

## Typical Operating Characteristics (continued)

(Circuit of Figure 2,  $V_{IN} = 5V$ ,  $C_{IN} = 0.1\mu F$ ,  $C_{OUT} = 1\mu F$ ,  $ON = SEL$ ,  $T_A = +25^\circ C$ , unless otherwise noted.)

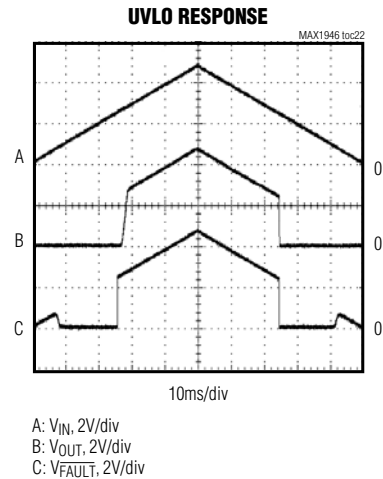
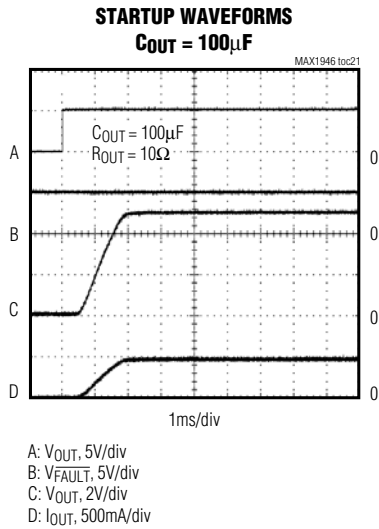

## Pin Description

PIN	NAME	FUNCTION
1	$\overline{FAULT}$	Fault-Indicator Output Switch. Open-drain output asserts low when switch enters thermal shutdown, undervoltage lockout, or a sustained (>20ms) current-limit or short-circuit condition.
2	GND	Ground
3, 4	OUT	Switch Power Output. Connect OUT pins together at the device and bypass with a $1\mu F$ ceramic capacitor. Load conditions may require additional bulk capacitance. When disabled, OUT goes into a high-impedance state.
5, 6	IN	Switch Power Input. Connect IN pins together at the device and bypass with a $0.1\mu F$ ceramic capacitor to GND. Input conditions may require additional bulk capacitance to prevent pulling the input supply down.
7	ON	ON/OFF Control Input. The active polarity of ON is set by SEL. Connect SEL high to make ON active high. Connect SEL to GND to make ON active low.
8	SEL	Logic Input Polarity Select. SEL sets the active polarity of the ON input. Connect SEL high to make ON active high. Connect SEL to GND to make ON active low.
—	EP	Exposed Metal Paddle. This paddle is internally connected to GND through a soft connect. For enhanced thermal dissipation, connect EP to a large ground plane. Do not use EP as a sole ground connection.

## Detailed Description

The MAX1946 includes output current limiting, short-circuit protection, thermal shutdown, an enable input, and fault indicator (see the *Functional Diagram*). A logic input at SEL sets the active polarity of the enable input. The fault indicator notifies the system when the current-limit, short-circuit, undervoltage lockout, or thermal-shutdown threshold is exceeded.

The MAX1946 operates from a 2.7V to 5.5V input supply and supplies a minimum output current of 740mA. A built-in current limit of 1.1A limits the output current in the event of an overload condition. A built-in short-circuit detection circuit pulses the output current if the output voltage falls below 1V. This lowers RMS output current and reduces power dissipation during continuous short conditions.



# Single USB Switch with Autoreset and Fault Blanking in Tiny TDFN

MAX1946

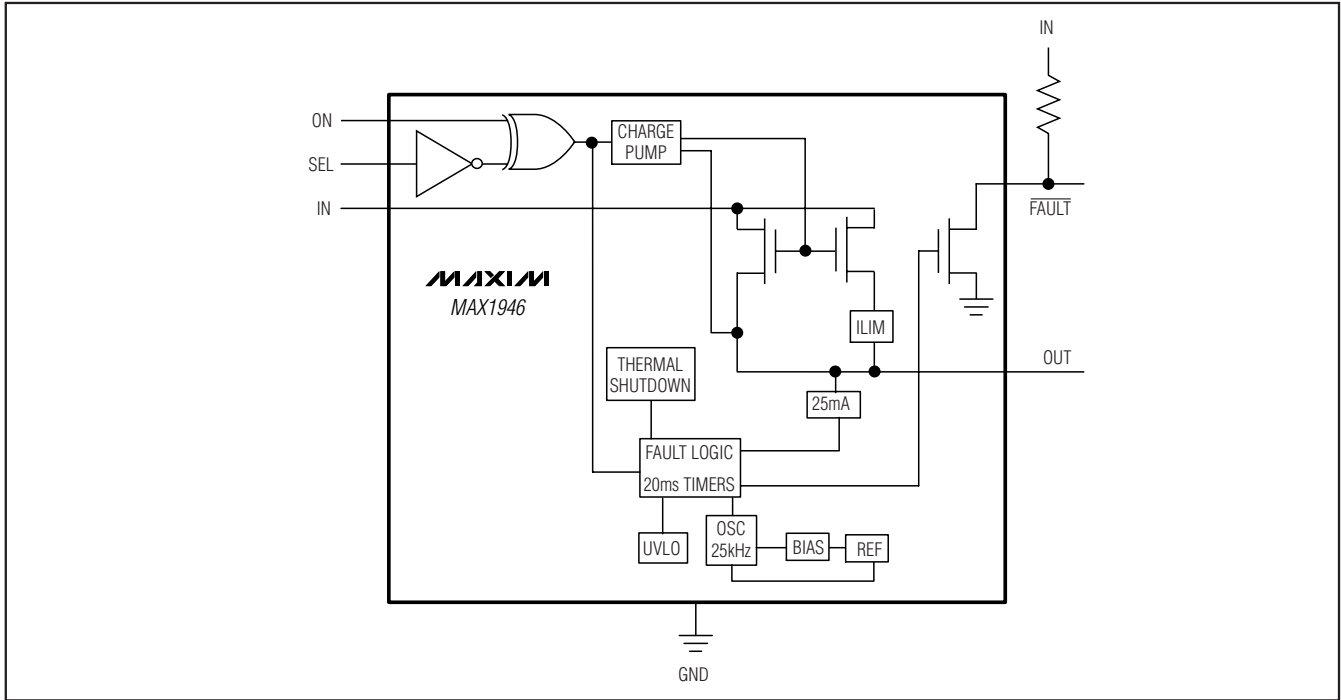

Figure 1. Functional Diagram

An internal micropower charge pump generates a high-side supply that drives the gate of an internal 75mV NMOS switch.

## On/Off Control and Undervoltage Lockout (UVLO)

SEL sets the active polarity of the logic input of the MAX1946. Connect ON to the same voltage as SEL to enable OUT. Connect ON to the opposite voltage as SEL to disable OUT (see Table 1). The output enters a high-impedance state when disabled.

The MAX1946 includes a UVLO circuit to prevent erroneous switch operation when the input voltage goes low during startup and brownout conditions. Input voltages less than 2.5V inhibit operation of the device.  $\overline{\text{FAULT}}$  asserts low during a UVLO condition.

## Output Fault Protection and Autoreset

The MAX1946 senses the switch output voltage and selects continuous current limiting for  $V_{\text{OUT}}$  greater than 1V or short-circuit current limiting for  $V_{\text{OUT}}$  less than 1V. When  $V_{\text{OUT}}$  is greater than 1V, the device operates in a continuous current-limit mode that limits output current to 1.1A. When  $V_{\text{OUT}}$  is less than 1V, the device operates in short-circuit current-limit mode, sourcing 1.2A pulses to the load. When either fault condition persists for 20ms, the output turns off and the

Table 1. On/Off Control

SEL	ON	OUT BEHAVIOR
GND	GND	ON
	$V_{\text{IN}}$	OFF
$V_{\text{IN}}$	GND	OFF
	$V_{\text{IN}}$	ON

fault flag asserts. The output automatically restarts 20ms after the short or overload is removed.

The MAX1946 detects short-circuit removal by sourcing 25mA from the output and monitoring the output voltage. When the voltage at the output exceeds 0.5V for 20ms, the fault flag resets, the output turns back on, and the 25mA current source turns off.

## Thermal Shutdown

When the MAX1946 die temperature exceeds +160°C the switch turns off and  $\overline{\text{FAULT}}$  goes low. Thermal shutdown does not utilize the 20ms fault-blanking timeout period. When the junction temperature cools by 15°C the switch turns on again and  $\overline{\text{FAULT}}$  returns high. The switch cycles on and off if the overload condition persists, resulting in a pulsed output that reduces the average system load.

# Single USB Switch with Autoreset and Fault Blanking in Tiny TDFN

## Fault Indicator

The MAX1946 provides an open-drain fault output,  $\overline{\text{FAULT}}$ . Connect  $\overline{\text{FAULT}}$  to IN through a 100k $\Omega$  pullup resistor for most applications.  $\overline{\text{FAULT}}$  asserts low when any of the following conditions occur:

- The input voltage is below the UVLO threshold.
- The switch junction temperature exceeds the +160°C thermal-shutdown temperature limit.
- The switch is in current-limit or short-circuit current-limit mode for more than 20ms.

The  $\overline{\text{FAULT}}$  output deasserts after a 20ms delay once the fault condition is removed. Ensure that the MAX1946 input bypass capacitance is sufficiently large to prevent load glitches from triggering the  $\overline{\text{FAULT}}$  output. Limit the input voltage slew rate to 0.2V/ $\mu\text{s}$  to prevent erroneous  $\overline{\text{FAULT}}$  indications.

To differentiate large capacitive loads from short circuits or sustained overloads, the MAX1946 has a fault-blanking circuit. When a load transient causes the device to enter current limit, an internal counter monitors the duration of the fault. For load faults exceeding the 20ms fault-blanking time, the switch turns off,  $\overline{\text{FAULT}}$  asserts low, and the device enters autoreset mode (see the *Output Fault Protection and Autoreset* section). Only current-limit and short-circuit faults are

blanked. Thermal-overload faults and input voltage drops below the UVLO threshold immediately turn the switch off and assert  $\overline{\text{FAULT}}$  low.

Fault blanking allows the MAX1946 to handle USB loads that may not be fully compliant with the USB specification. The MAX1946 successfully powers USB loads with additional bypass capacitance and/or large startup currents while protecting the upstream power source. No fault is reported if the switch brings up the load within the 20ms blanking period. See Table 2 for a summary of current limit and fault behavior.

## Applications Information

### Typical Application Circuit

#### Input Power Supply and Capacitance

Connect both IN inputs together. IN powers the internal control circuitry and charge pump for the switch. Bypass IN to GND with a 0.1 $\mu\text{F}$  ceramic capacitor. When driving inductive loads or operating from inductive sources, which may occur when the MAX1946 is powered by long leads or PC traces, larger input bypass capacitance is required to prevent voltage spikes from exceeding the MAX1946's absolute maximum ratings during short-circuit events.

**Table 2. Current Limiting and Fault Behavior**

CONDITION	MAX1946 BEHAVIOR
Output Short Circuit ( $V_{\text{OUT}} < 1\text{V}$ )	<ul style="list-style-type: none"> <li>• If a short is detected at the output, the switch turns off, and the blanking timer begins. <math>\overline{\text{FAULT}}</math> remains high during the blanking timeout period.</li> <li>• If the short persists during the fault-blanking period, the output pulses at 0.35A<sub>RMS</sub>. If the short is removed before the 18ms short-circuit blanking timeout period, the next ramped current pulse soft starts the output. <math>\overline{\text{FAULT}}</math> remains high.</li> <li>• If the short circuit persists after the fault-blanking period, <math>\overline{\text{FAULT}}</math> goes low, autoreset mode begins, and the output sources 25mA.</li> <li>• If the output voltage rises above 0.5V for 20ms, the switch resets, the output turns on, and <math>\overline{\text{FAULT}}</math> goes high (see Short-Circuit Response in the <i>Typical Operating Characteristics</i>.)</li> </ul>
Output Overload Current ( $V_{\text{OUT}} > 1\text{V}$ )	<ul style="list-style-type: none"> <li>• Output current regulates at I<sub>LIM</sub> and the blanking timer turns on. <math>\overline{\text{FAULT}}</math> remains high during the blanking timeout period.</li> <li>• Continuous current at I<sub>LIM</sub> persists until either the 20ms blanking period expires or a thermal fault occurs.</li> <li>• If overcurrent persists after 20ms, <math>\overline{\text{FAULT}}</math> goes low, autoreset mode is enabled, and the output sources 25mA.</li> <li>• If the output voltage rises above 0.5V for 20ms, the switch resets, the output turns on, and <math>\overline{\text{FAULT}}</math> goes high (see Short Overload Response in the <i>Typical Operating Characteristics</i>.)</li> </ul>
Thermal Fault ( $T_{\text{J}} > +160^{\circ}\text{C}$ )	<ul style="list-style-type: none"> <li>• A junction temperature of +160°C immediately asserts <math>\overline{\text{FAULT}}</math> low (the blanking timeout period does not apply for thermal faults) and turns off the switch. When the junction cools by 15°C, the thermal fault is cleared and <math>\overline{\text{FAULT}}</math> goes high. Note that if other fault conditions are present when a thermal fault clears, those fault states then take effect.</li> </ul>

# Single USB Switch with Autoreset and Fault Blanking in Tiny TDFN

MAX1946

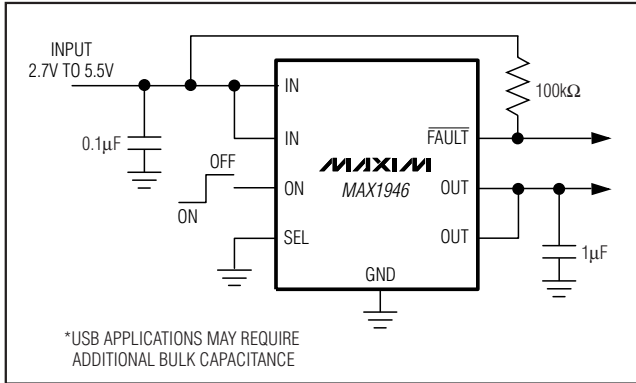

Figure 2. Typical Application Circuit

## Output Capacitor

Bypass OUT to GND with a 1µF ceramic capacitor for local decoupling. Additional bulk capacitance (up to 470µF) reduces output-voltage transients under dynamic load conditions. Using output capacitors greater than 470µF can assert FAULT if the current limit cannot charge the output capacitor within the 20ms fault-blanking period. In addition to bulk capacitance, small-value (0.1µF or greater) ceramic capacitors improve the output's resilience to electrostatic discharge (ESD).

## Driving Inductive Loads

A wide variety of devices (mice, keyboards, cameras, and printers) typically connect to the USB port with cables, which can add an inductive component to the load. This inductance causes the output voltage at the USB port to oscillate during a load step. The MAX1946 drives inductive loads, but avoid exceeding the device's absolute maximum ratings. The load inductance is usually relatively small, and the MAX1946 input typically includes substantial bulk capacitance from an upstream regulator as well as local bypass capacitors, limiting overshoot. If severe ringing occurs due to large load inductance, clamp the MAX1946 output below +6V and above -0.3V.

## Turn-On and Turn-Off Behavior

When turned on, the MAX1946 output ramps up over 1.2ms to eliminate load transients on the upstream power source. When turned off, the output ramps down for 3ms. Under fault conditions, the output of the MAX1946 turns off rapidly to provide maximum safety for the upstream power source and downstream devices. Internal blocks shut down to minimize supply current when the switch is off.

## Layout and Thermal Dissipation

Keep all traces as short as possible to reduce the effect of undesirable parasitic inductance, and to optimize the switch response time to output short-circuit conditions. Place input and output capacitors no more than 5mm from device leads. Connect IN and OUT to the power bus with short traces. The exposed pad on the TDFN package underside must be soldered to the PC board in order to realize the rated package dissipation.

An active switch dissipates little power with minimal change in package temperature. Calculate the power dissipation for this condition as follows:

$$P = (I_{OUT})^2 \times R_{ON}$$

At the normal operating current ( $I_{OUT} = 0.5A$ ) and the maximum on-resistance of the switch ( $90m\Omega$ ), the power dissipation is:

$$P = (0.5A)^2 \times 0.09\Omega = 22.5mW$$

The worst-case power dissipation occurs when the output current is just below the current-limit threshold (1.2A max) with an output voltage just greater than 1V. In this case, the power dissipated is the voltage drop across the switch multiplied by the current limit:

$$P = I_{LIM} \times (V_{IN} - V_{OUT})$$

For a 5V input and 1V output, the maximum power dissipation per switch is:

$$P = 1.2A \times (5V - 1V) = 4.8W$$

Since the package power dissipation is 1951mW for the 8-pin TDFN, the MAX1946 die temperature exceeds the +160°C thermal-shutdown threshold. The switch output shuts down until the junction temperature cools by 15°C. The duty cycle and period are strong functions of the ambient temperature and the PC board layout (see the *Thermal Shutdown* section).

If the output current exceeds the current-limit threshold, or the output voltage is pulled below the short-circuit detect threshold, the MAX1946 enters a fault state after 20ms, at which point autoreset mode is enabled and 25mA is sourced by the output. For a 5V input, OUT short-circuited to GND, and autoreset mode active, the power dissipation is as follows:

$$P = 0.025A \times 5V = 0.125W$$

# Single USB Switch with Autoreset and Fault Blanking in Tiny TDFN

## Chip Information

PROCESS: BiCMOS

## Package Information

For the latest package outline information and land patterns, go to [www.maxim-ic.com/packages](http://www.maxim-ic.com/packages). Note that a "+", "#", or "-" in the package code indicates RoHS status only. Package drawings may show a different suffix character, but the drawing pertains to the package regardless of RoHS status.

PACKAGE TYPE	PACKAGE CODE	DOCUMENT NO.
8 TDFN-EP	T833+1	<a href="#">21-0137</a>

# Single USB Switch with Autoreset and Fault Blanking in Tiny TDFN

## Revision History

REVISION NUMBER	REVISION DATE	DESCRIPTION	PAGES CHANGED
3	2/10	Removed UL Certification Pending bullet from <i>Features</i> section	1

MAX1946

Maxim cannot assume responsibility for use of any circuitry other than circuitry entirely embodied in a Maxim product. No circuit patent licenses are implied. Maxim reserves the right to change the circuitry and specifications without notice at any time.

Maxim Integrated Products, 120 San Gabriel Drive, Sunnyvale, CA 94086 408-737-7600 \_\_\_\_\_ 13

# Mouser Electronics

Authorized Distributor

Click to View Pricing, Inventory, Delivery & Lifecycle Information:

[Maxim Integrated:](#)

[MAX1946ETA+T](#)