



QPA1009D

10.7 – 12.7 GHz 17.5 Watt GaN Amplifier

Product Overview

Qorvo's QPA1009D is a wide band power amplifier MMIC fabricated on Qorvo's production 0.15 um GaN on SiC process (QGaN15). Covering 10.7–12.7 GHz, the QPA1009D provides > 17.5 Watts of saturated output power and 17 dB of large-signal gain while achieving > 40% power-added efficiency.

The QPA1009D RF input port is DC coupled to ground for optimum ESD performance. The QPA1009D RF ports have DC blocking capacitors and are matched to 50 ohms.

The QPA1009D can support a wide range of operating conditions, including CW operation, making it well-suited for both commercial and military systems.

Lead-free and RoHS compliant.



Key Features

- Frequency Range: 10.7 – 12.7 GHz
- P_{SAT} ($P_{IN}=27$ dBm): > 43.5 dBm
- PAE ($P_{IN}=27$ dBm): > 40 %
- Power Gain ($P_{IN}=27$ dBm): > 17 dB
- Small Signal Gain: > 22 dB
- Bias: $V_D = 20$ V, $I_{DQ} = 600$ mA
- Die Dimensions: 3.16 x 4.24 x 0.10 mm

Performance is typical across frequency. Please reference electrical specification table and data plots for more details.

Functional Block Diagram

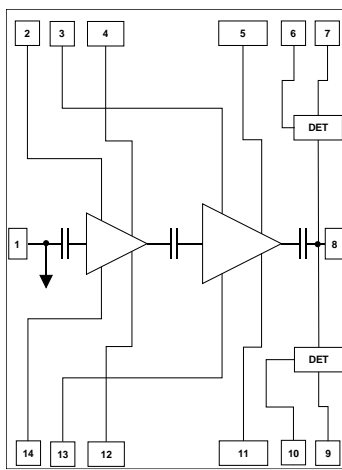

Applications

- Satellite Communications
- Radar
- Point to Point Communications

Ordering Information

Part No.	Description
QPA1009D	10.7 – 12.7 GHz 17.5 W GaN Amplifier (10 Pcs.)
QPA1009DEVBV1	Evaluation Board for QPA1009D

Absolute Maximum Ratings

Parameter	Value / Range
Drain Voltage (V_D)	29.5 V
Gate Voltage Range (V_G)	-4 V to 0 V
Drain Current (I_{D1}/I_{D2}) (T=85 °C)	0.42 / 4.0 A
Gate Current (I_G)	See plot pg. 12
Power Dissipation (P_{DISS}), 85 °C	59.5 W
Input Power (P_{IN}), 50 Ω , CW, $V_D=20$ V, $I_{DQ}=600$ mA, 85 °C	34 dBm
Input Power (P_{IN}), 3:1 VSWR, CW, $V_D=20$ V, $I_{DQ}=600$ mA, 85 °C	34 dBm
Soldering Temperature (30 seconds, maximum)	320 °C
Storage Temperature	-55 to +125 °C

Operation of this device outside the parameter ranges given above may cause permanent damage. These are stress ratings only, and functional operation of the device at these conditions is not implied.

Recommended Operating Conditions

Parameter	Value / Range
Drain Voltage (V_D)	20 V
Drain Current (I_{DQ})	600 mA
Operating Temperature	-40 to +85 °C

Electrical specifications are measured at specified test conditions. Specifications are not guaranteed over all recommended operating conditions.

Electrical Specifications

Parameter		Min	Typ	Max	Units
Operational Frequency		10.7		12.7	GHz
Output Power ($P_{IN} = 27$ dBm)	10.7 GHz		44.2		dBm
	11.7 GHz		44.2		dBm
	12.7 GHz		43.6		dBm
Power Added Efficiency ($P_{IN} = 27$ dBm)	10.7 GHz		43.6		%
	11.7 GHz		44.0		%
	12.7 GHz		40.9		%
Small Signal Gain	10.7 GHz		23.1		dB
	11.7 GHz		22.8		dB
	12.7 GHz		22.1		dB
Input Return Loss	10.7 GHz		14		dB
	11.7 GHz		23		dB
	12.7 GHz		27		dB
Output Return Loss	10.7 GHz		9		dB
	11.7 GHz		10		dB
	12.7 GHz		5		dB
Intermodulation Level (IMD3) ($P_{out}/Tone = 35$ dBm)			-33		dBc
2 ND Harmonic Level (Fundamental $P_{IN} = 24$ dBm)			-33		dBc
Output Power Temp. Coeff. (85 °C to 25 °C, $P_{IN} = 27$ dBm)			-0.018		dB/°C
Sm. Sig. Gain Temp. Coefficient (85 °C to -40 °C)			-0.061		dB/°C

Test conditions, unless otherwise noted: T = 25 °C, $V_D = 20$ V, $I_{DQ} = 600$ mA

Performance Plots – Large Signal

Test conditions, unless otherwise noted: $V_D = 20\text{ V}$, $I_{DQ} = 600\text{ mA}$, $T = +25\text{ }^\circ\text{C}$, $P_{IN} = 27\text{ dBm}$

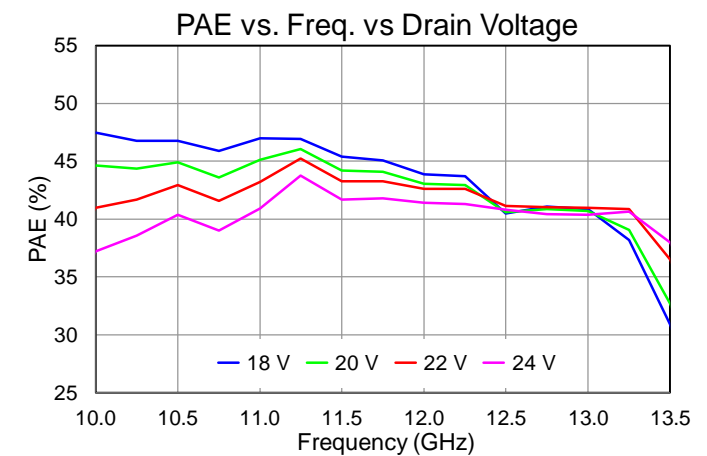
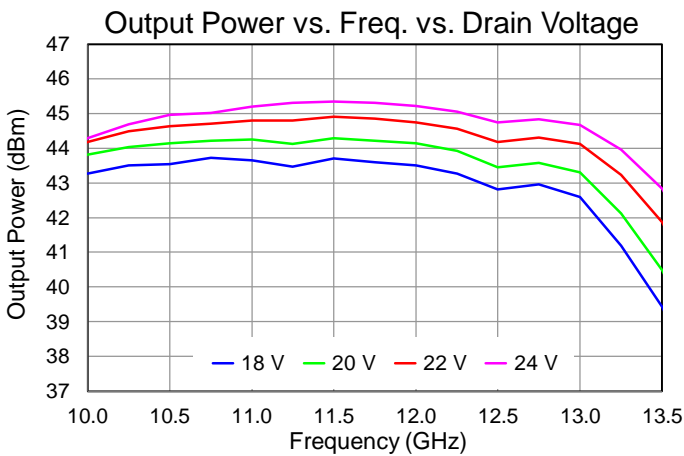
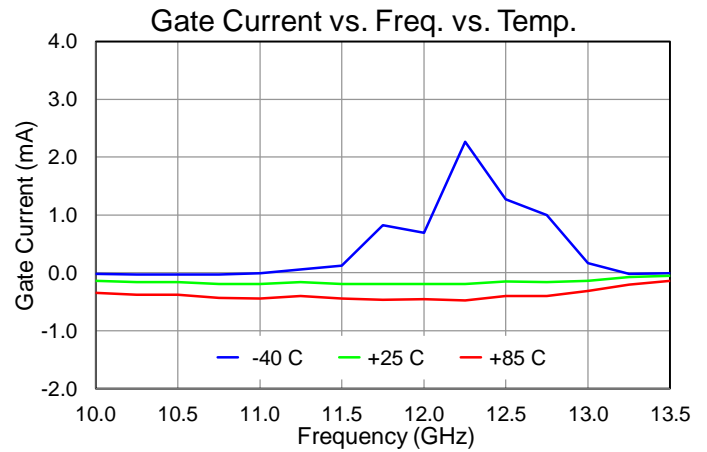
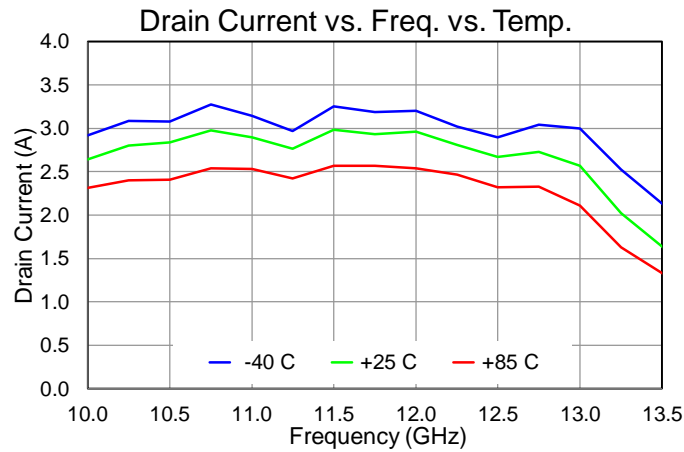
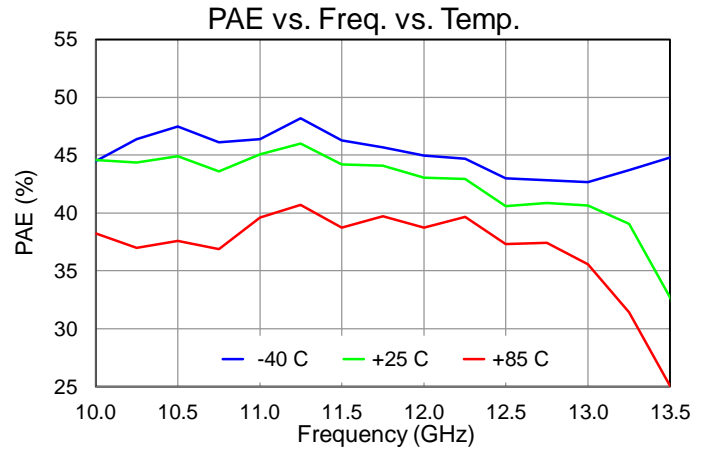
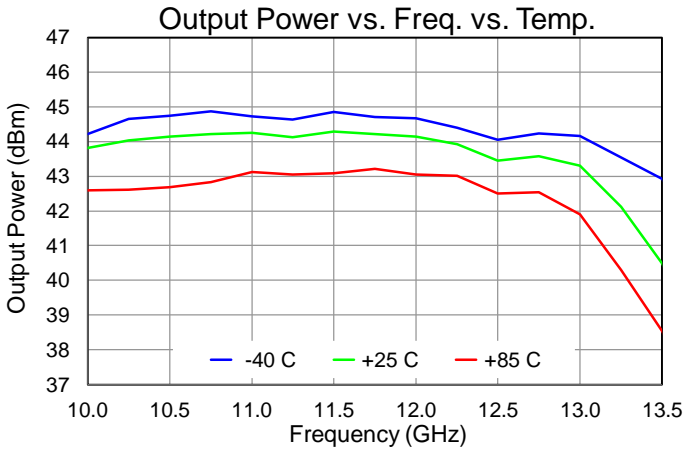

Performance Plots – Large Signal

Test conditions, unless otherwise noted: $V_D = 20\text{ V}$, $I_{DQ} = 600\text{ mA}$, $T = +25\text{ }^\circ\text{C}$, $P_{IN} = 27\text{ dBm}$

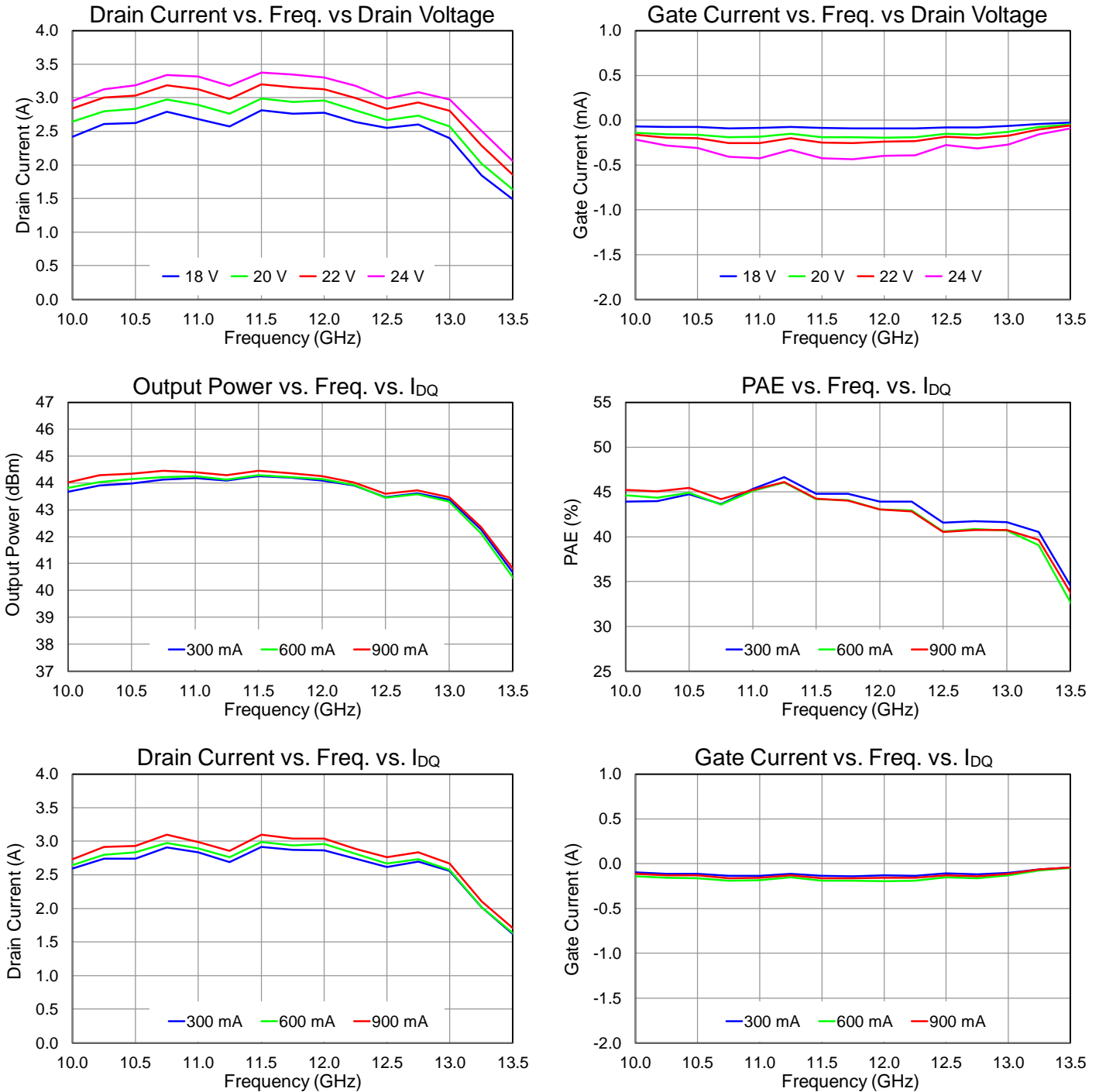

Performance Plots – Large Signal

Test conditions, unless otherwise noted: $V_D = 20\text{ V}$, $I_{DQ} = 600\text{ mA}$, $T = +25\text{ }^\circ\text{C}$

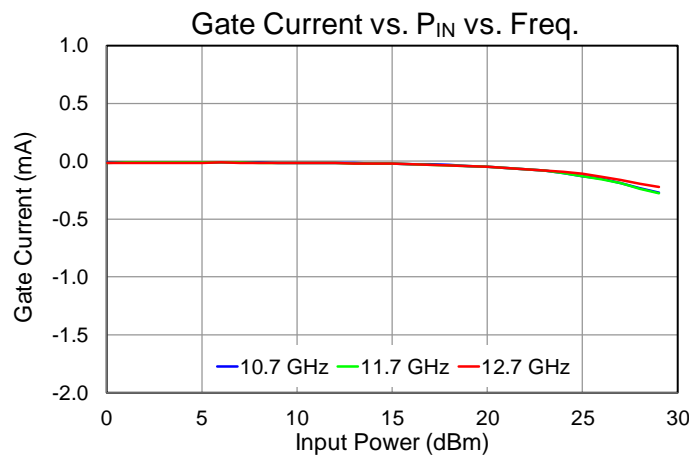
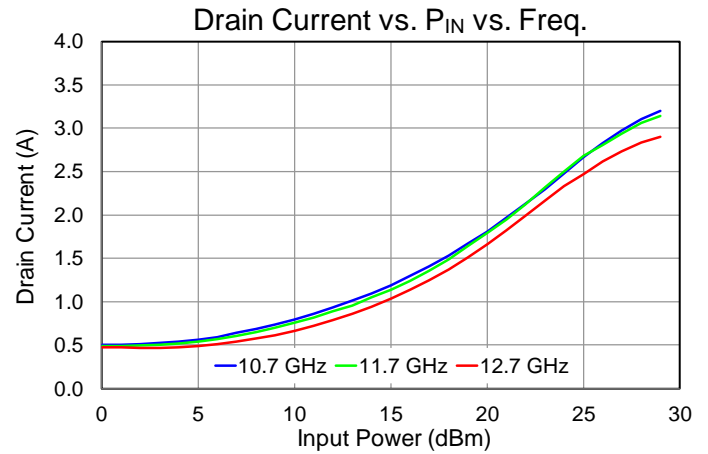
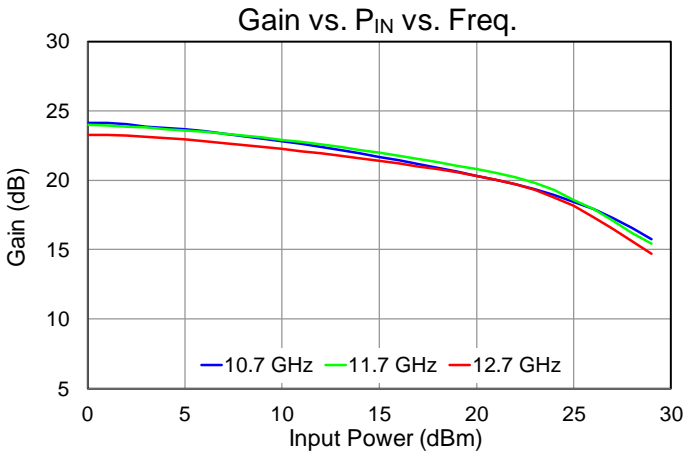
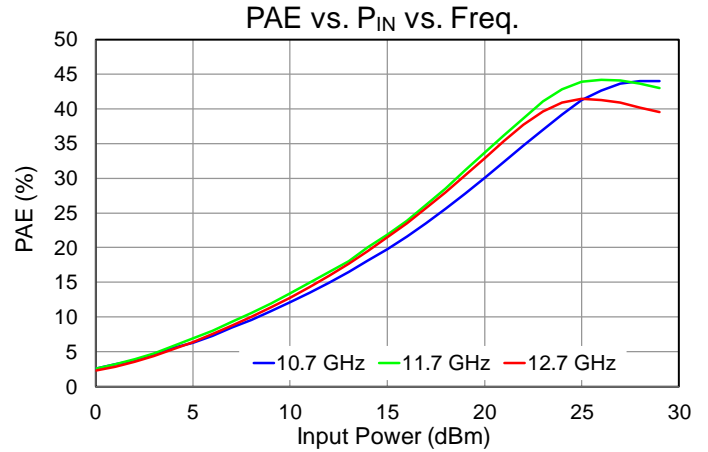
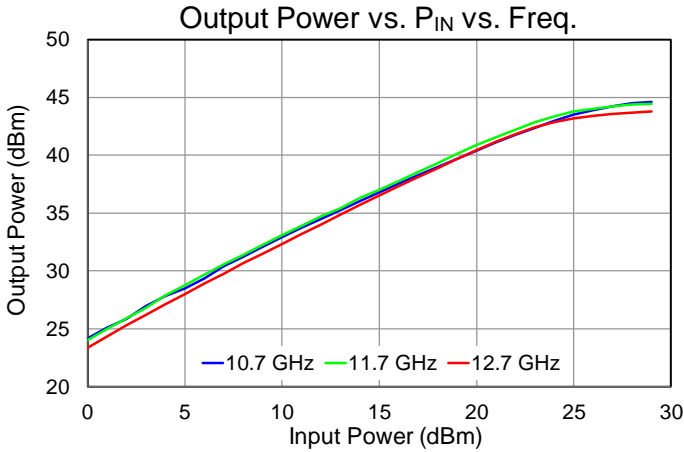

Performance Plots – Large Signal

Test conditions, unless otherwise noted: $V_D = 20\text{ V}$, $I_{DQ} = 600\text{ mA}$, $T = +25\text{ }^\circ\text{C}$, Frequency = 11.7 GHz

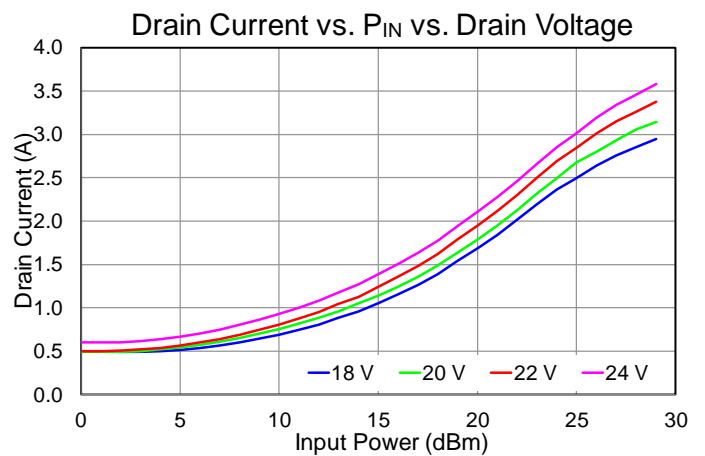
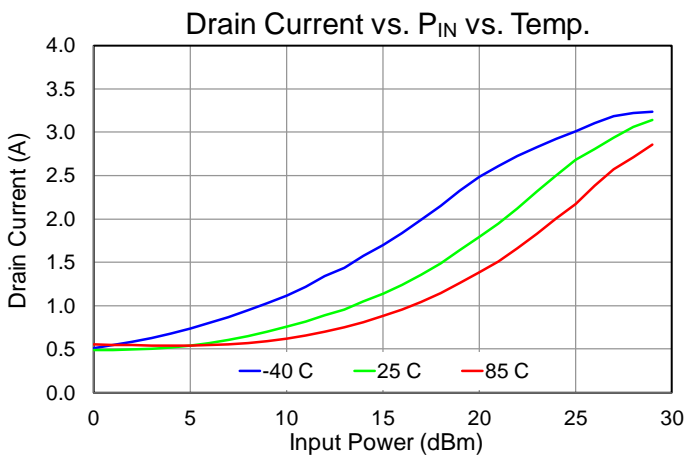
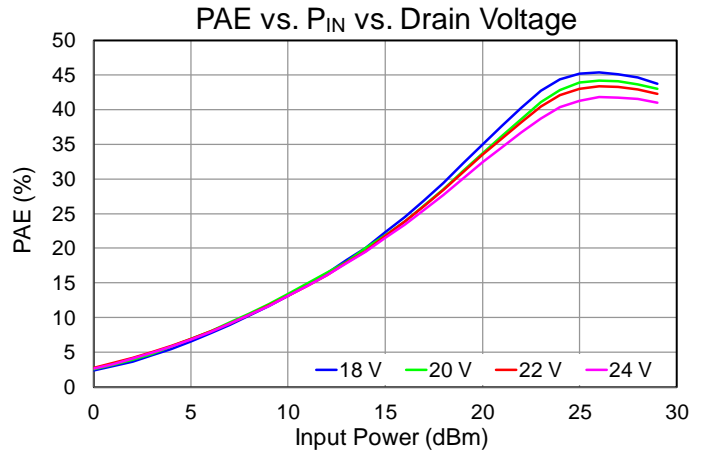
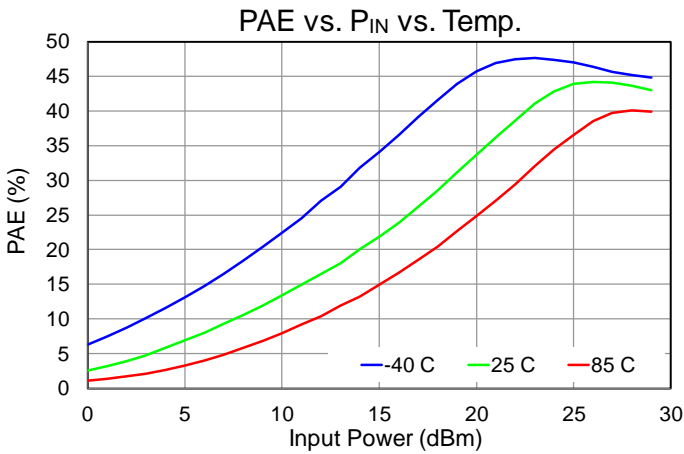
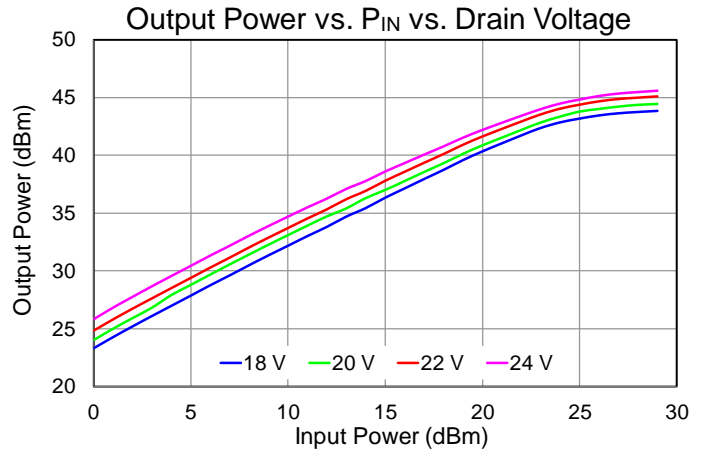
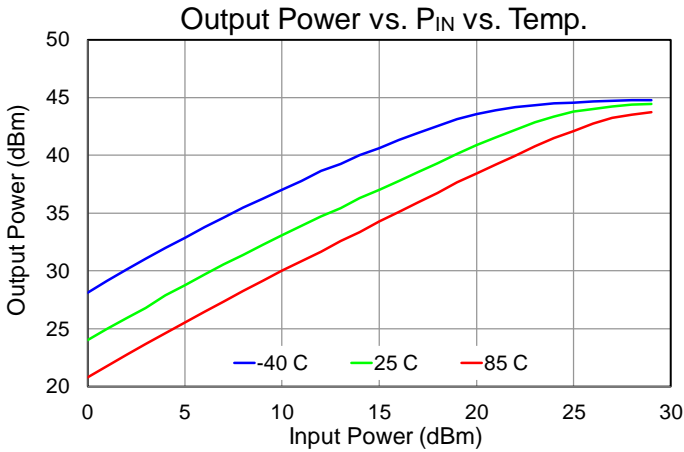

Performance Plots – Large Signal

Test conditions, unless otherwise noted: $V_D = 20\text{ V}$, $I_{DQ} = 600\text{ mA}$, $T = +25\text{ }^\circ\text{C}$, Frequency = 11.7 GHz

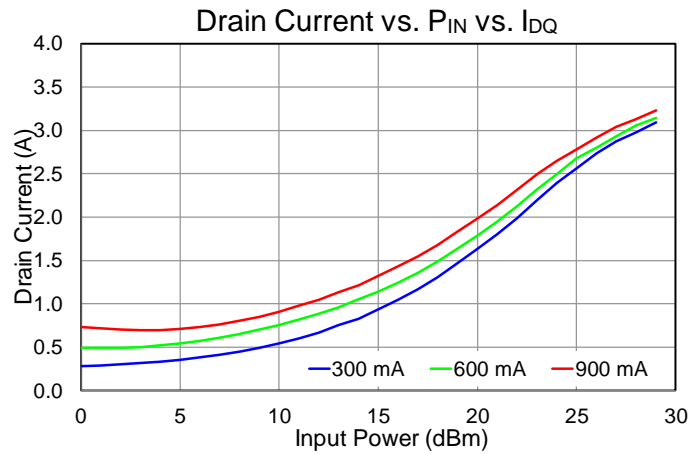
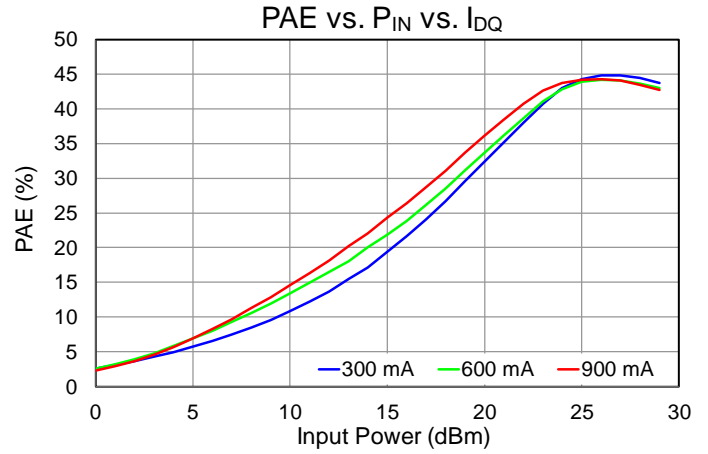
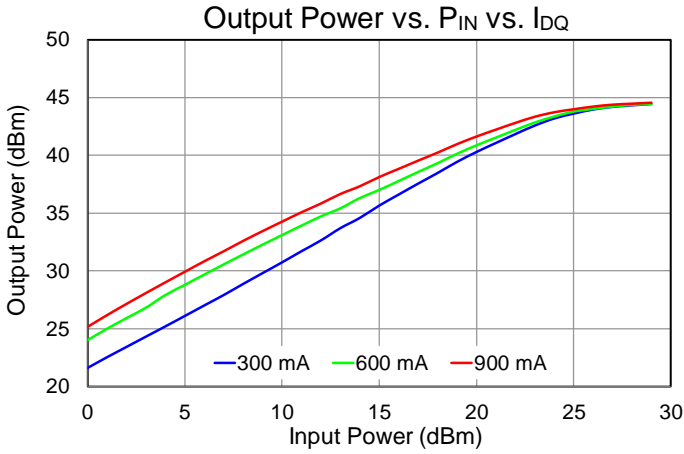

Performance Plots – Linearity

Test conditions, unless otherwise noted: $V_D = 20\text{ V}$, $I_{DQ} = 600\text{ mA}$, $T = +25^\circ\text{C}$, $F_c = 11.7\text{ GHz}$, Tone Spacing = 1 MHz

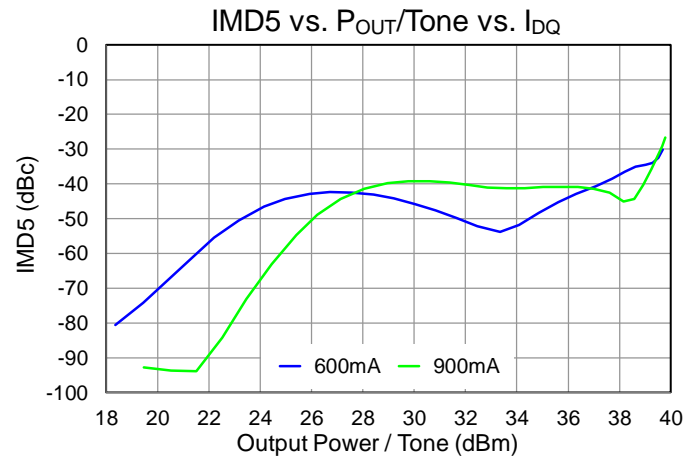
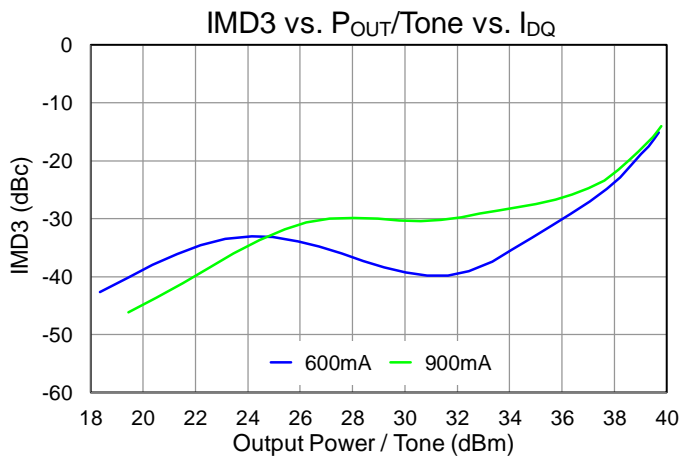
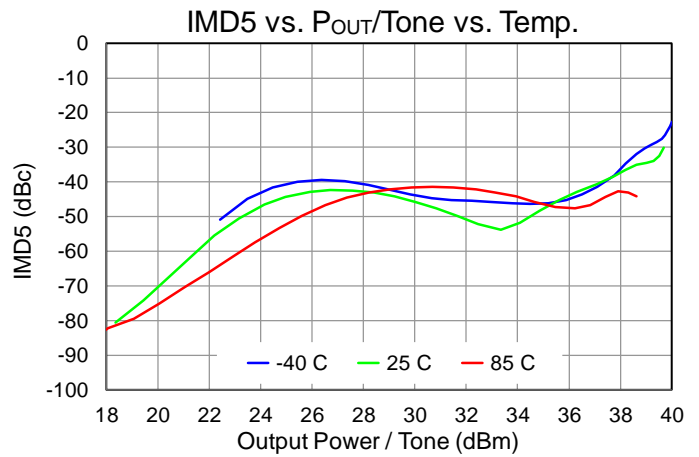
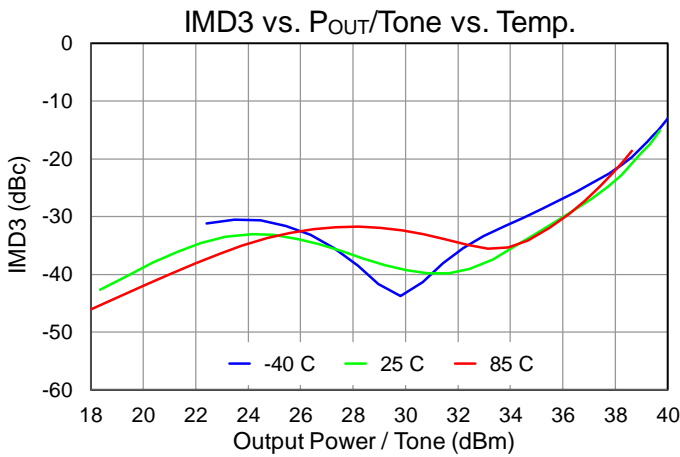
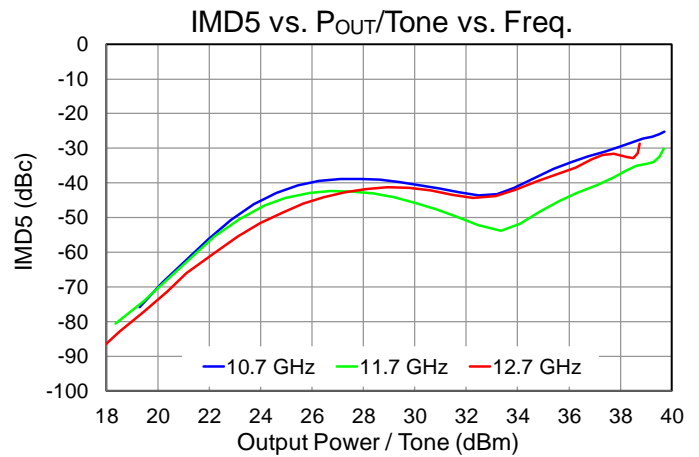
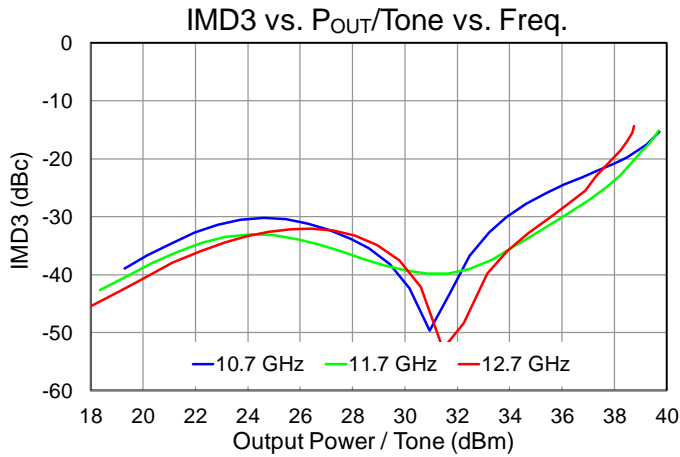

Performance Plots – Linearity, Harmonics

Test conditions, unless otherwise noted: $V_D = 20\text{ V}$, $I_{DQ} = 600\text{ mA}$, $T = +25\text{ }^\circ\text{C}$, $F_c = 11.7\text{ GHz}$

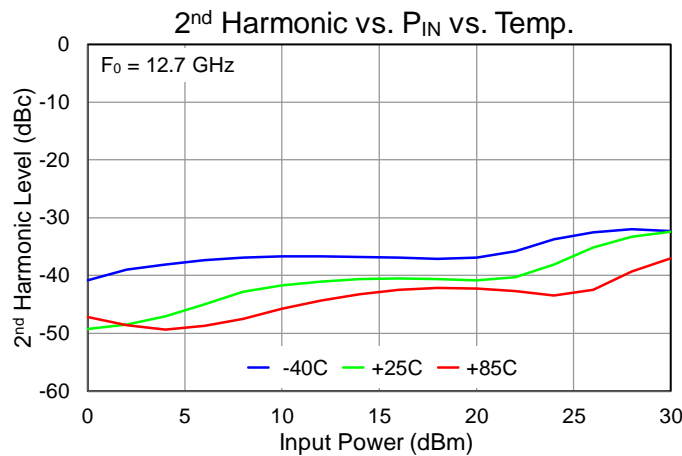
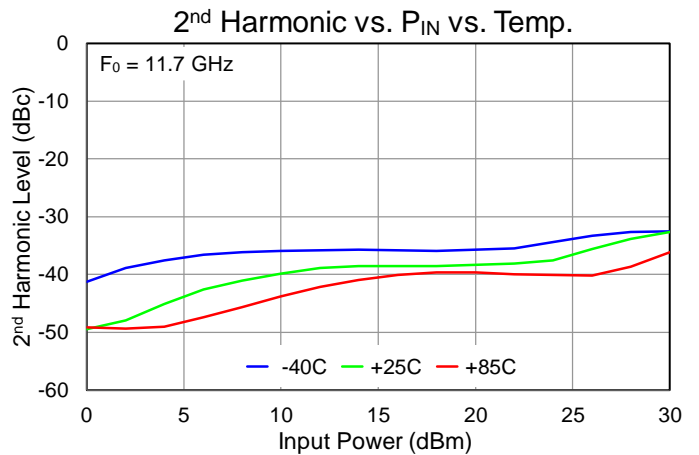
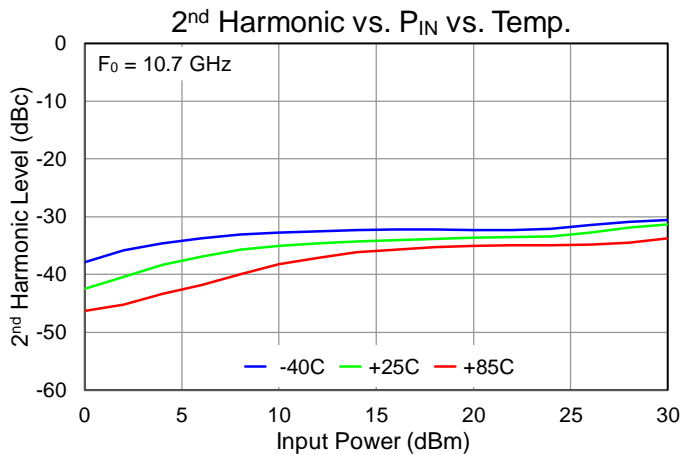
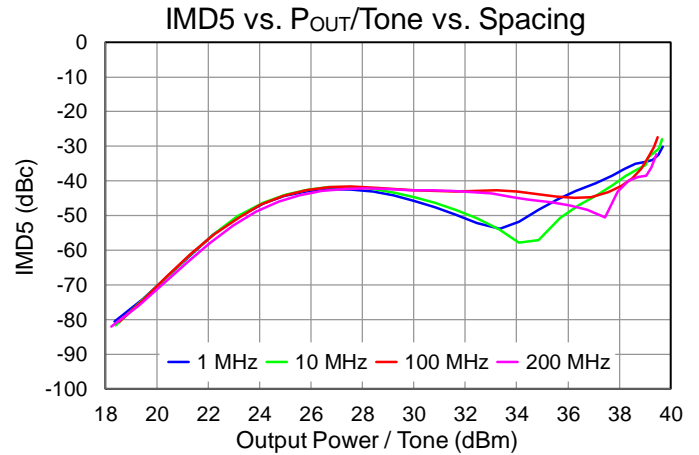
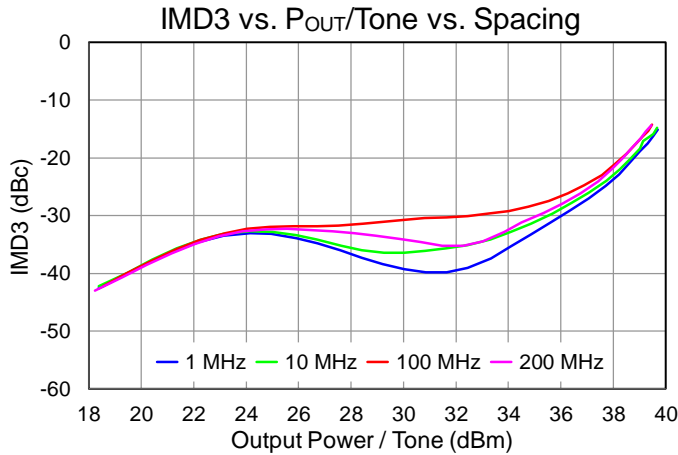

Performance Plots – Small Signal

Test conditions, unless otherwise noted: $V_D=20\text{ V}$, $I_{DQ}=600\text{ mA}$, $T=+25\text{ }^\circ\text{C}$

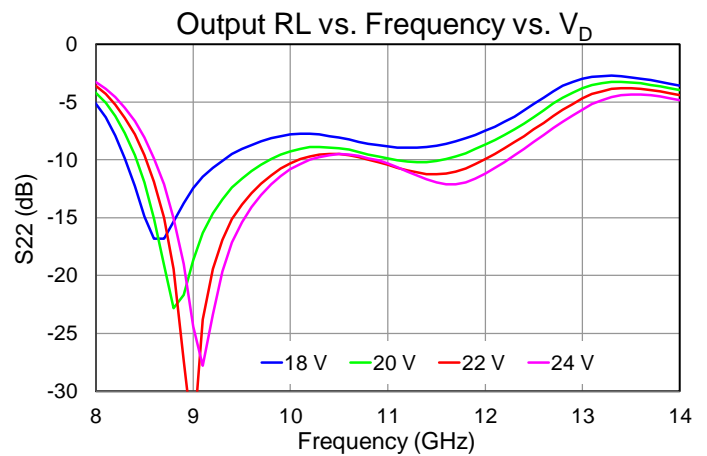
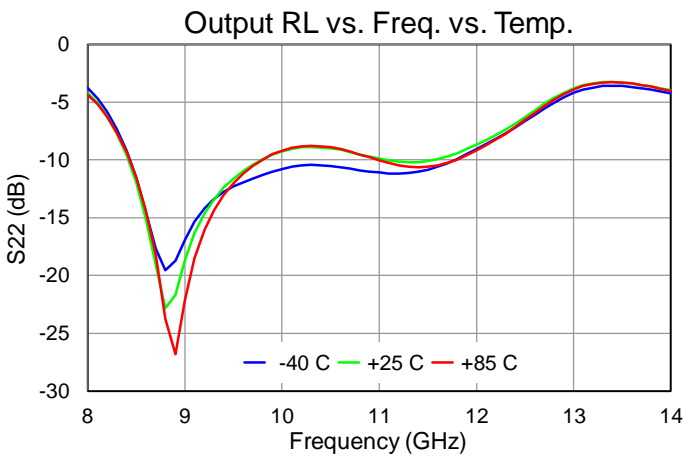
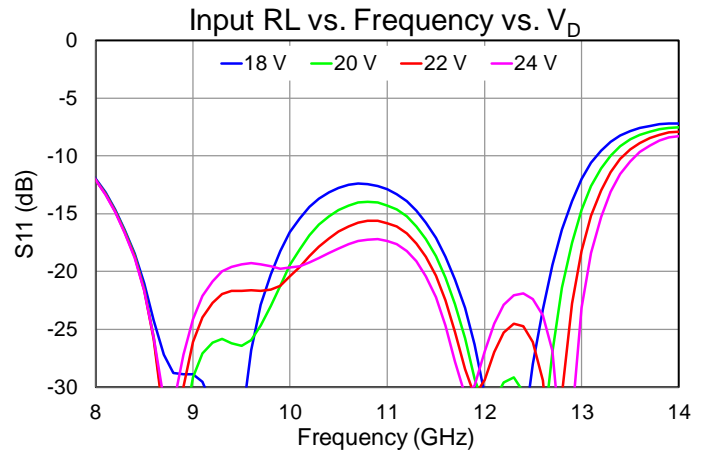
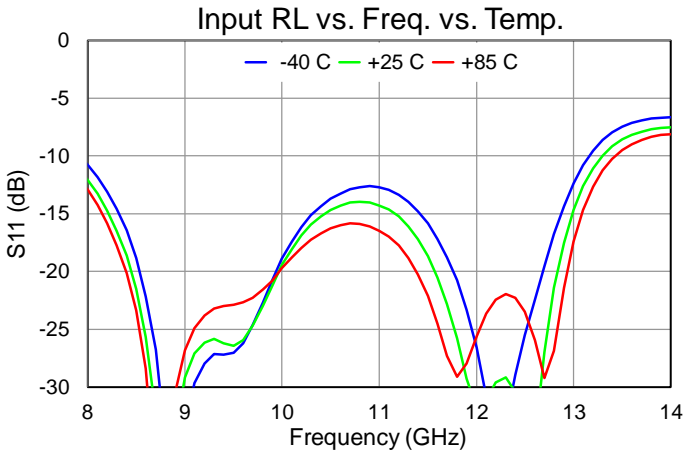
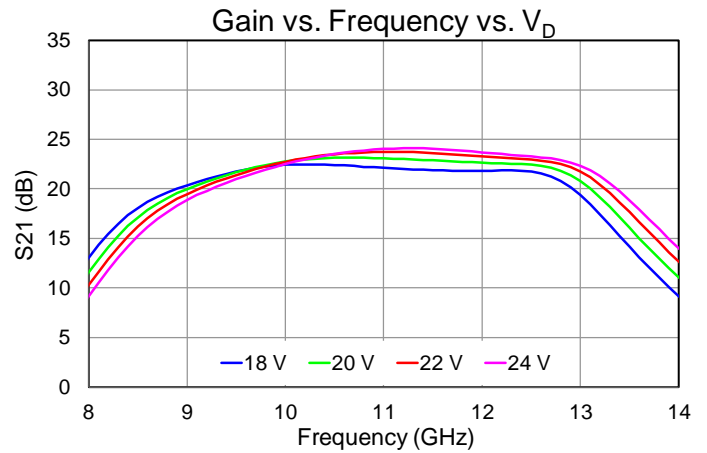
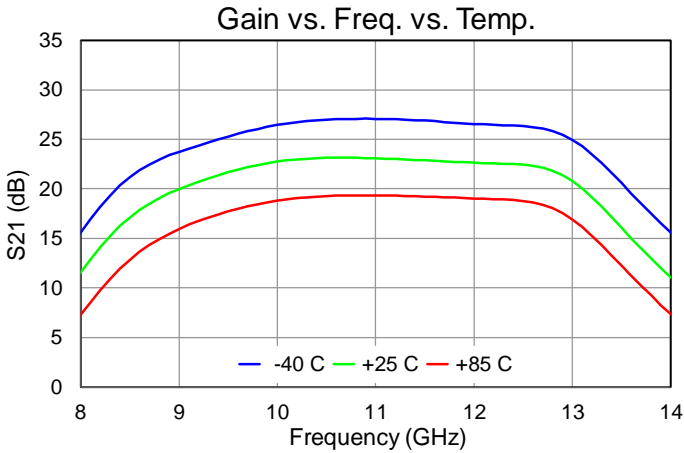

Performance Plots – Small Signal

Test conditions, unless otherwise noted: $V_D=20\text{ V}$, $I_{DQ}=600\text{ mA}$, $T=+25\text{ }^\circ\text{C}$

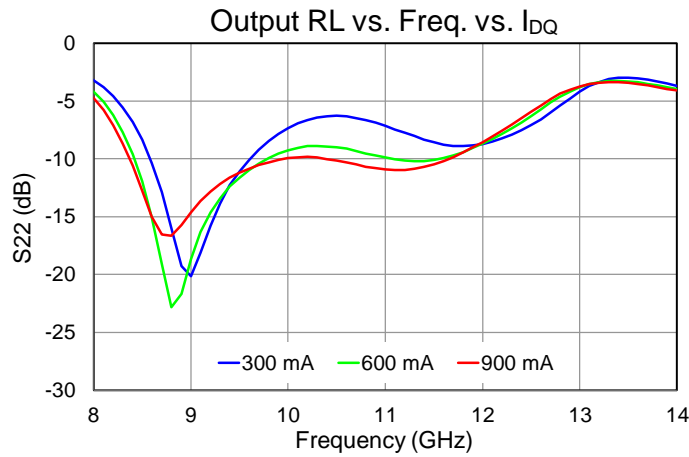
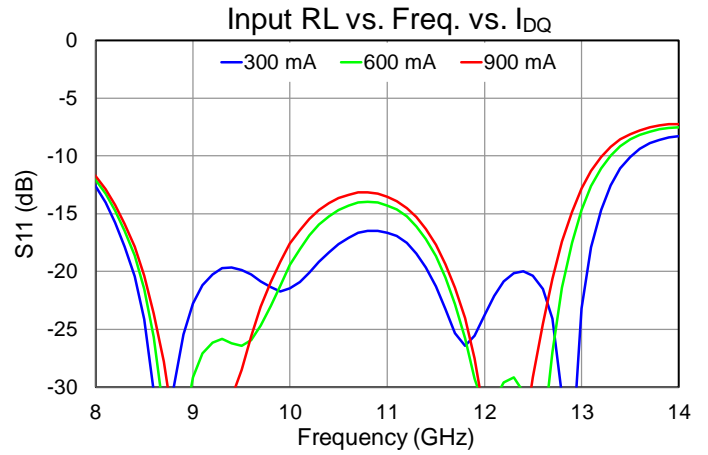
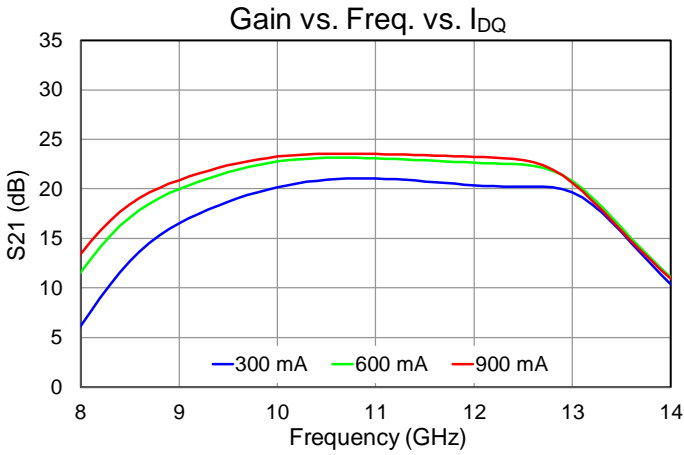

Thermal and Reliability Information

Parameter	Test Conditions	Value	Units
Thermal Resistance (θ_{JC}) ⁽¹⁾	T _{base} = 85 °C, V _D = 20 V, I _{DQ} = 600 mA, P _{DISS} = 12 W, No RF (quiescent DC operation)	1.25	°C/W
Channel Temperature, T _{CH} ⁽²⁾		100.0	°C
Thermal Resistance (θ_{JC}) ⁽¹⁾	T _{base} = 85 °C, V _D = 20 V, I _{DQ} = 600 mA, Freq = 10.7 GHz, I _{D_Drive} = 2.54 A, P _{IN} = 27 dBm, P _{OUT} = 42.8 dBm, P _{DISS} = 32.0 W	1.42	°C/W
Channel Temperature, T _{CH} (Under RF) ⁽²⁾		130.5	°C

Notes:

- Thermal resistance determined to the back of a 20 mil Cu-Mo carrier plate with eutectic die attach (85 °C)
- Refer to the following document: [GaN Device Channel Temperature, Thermal Resistance, and Reliability Estimates](#)

Dissipated Power and Maximum Gate Current

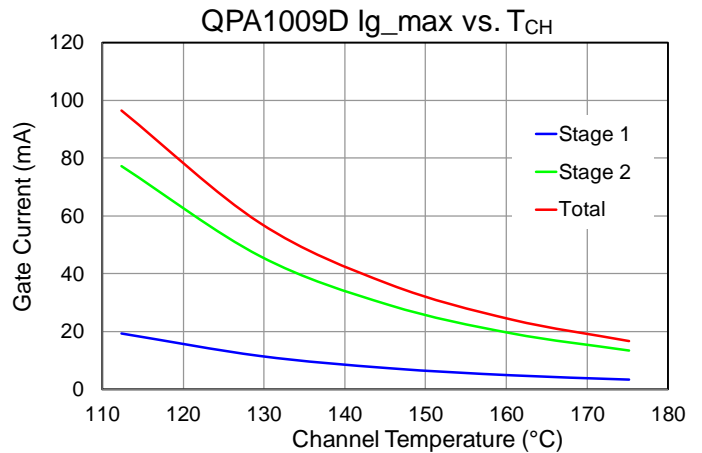
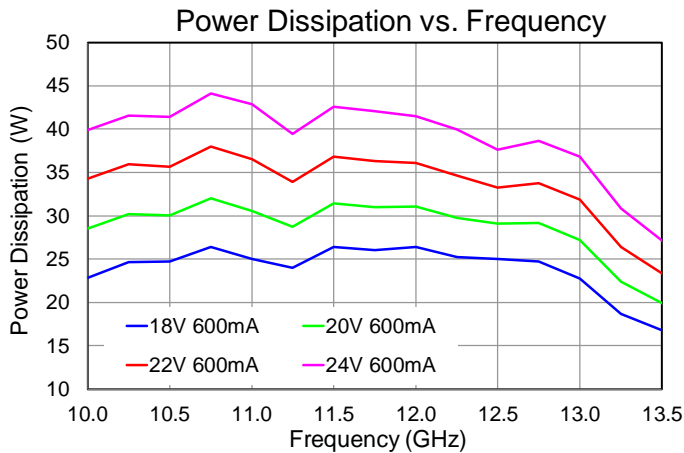

Test conditions, unless otherwise noted: I_{DQ} = 600 mA, T = +85 °C, P_{IN} = 27 dBm

Applications Information

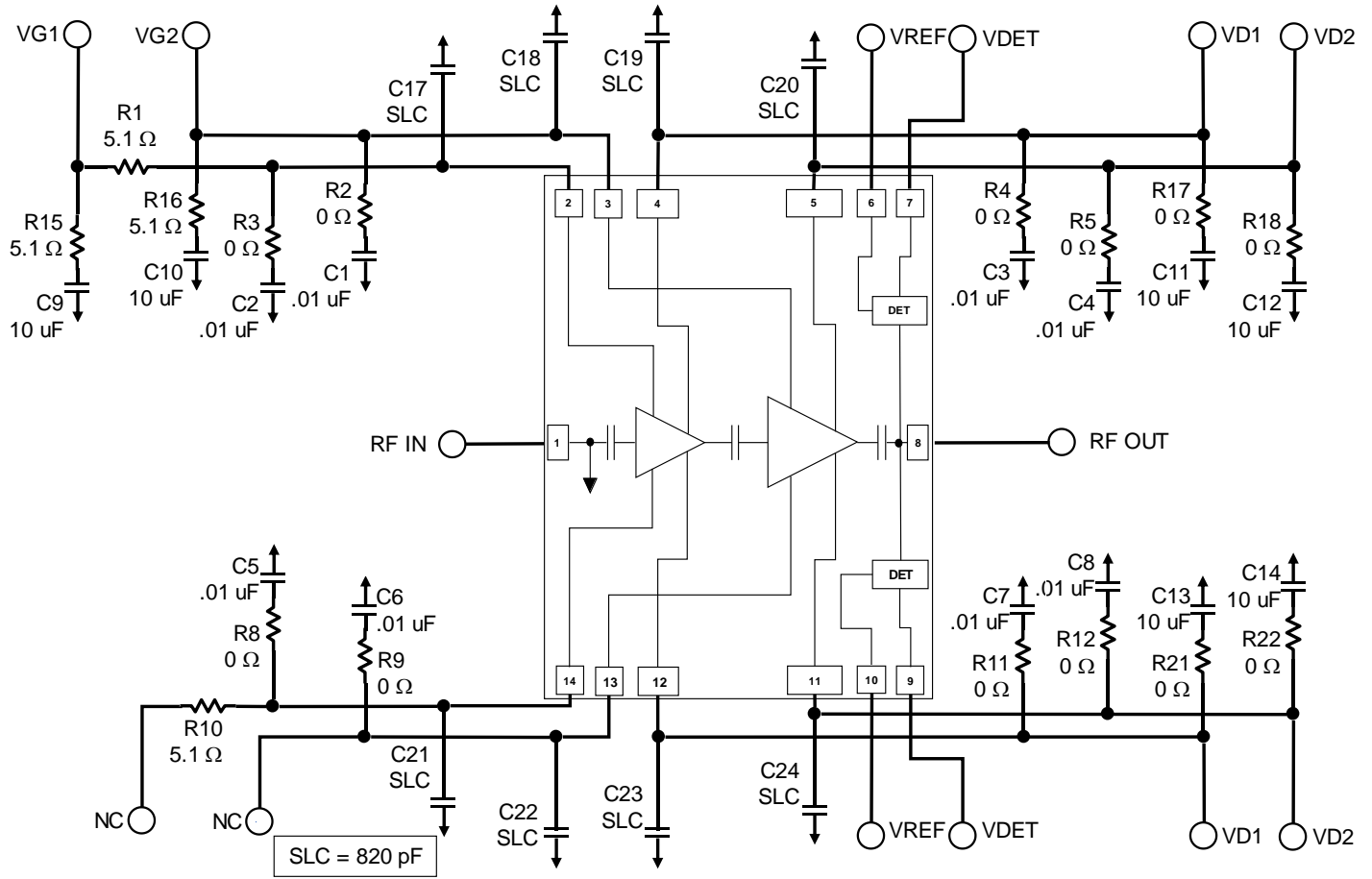

Note: V_{D1} and V_{D2} must be biased from both sides.
 V_{G1} and V_{G2} can be tied together, as can V_{D1} and V_{D2} .

Bias-Up Procedure

1. Set I_D limit to 3750 mA, I_G limit to 20 mA
2. Set V_G to -4.0 V
3. Set V_D +20 V
4. Adjust V_G more positive until $I_{DQ} \approx 600$ mA
5. Apply RF signal

Bias-Down Procedure

1. Turn off RF signal
2. Reduce V_G to -4.0 V. Ensure $I_{DQ} \sim 0$ mA
4. Set V_D to 0 V
5. Turn off V_D supply
6. Turn off V_G supply

Evaluation Board (EVB) Layout Assembly

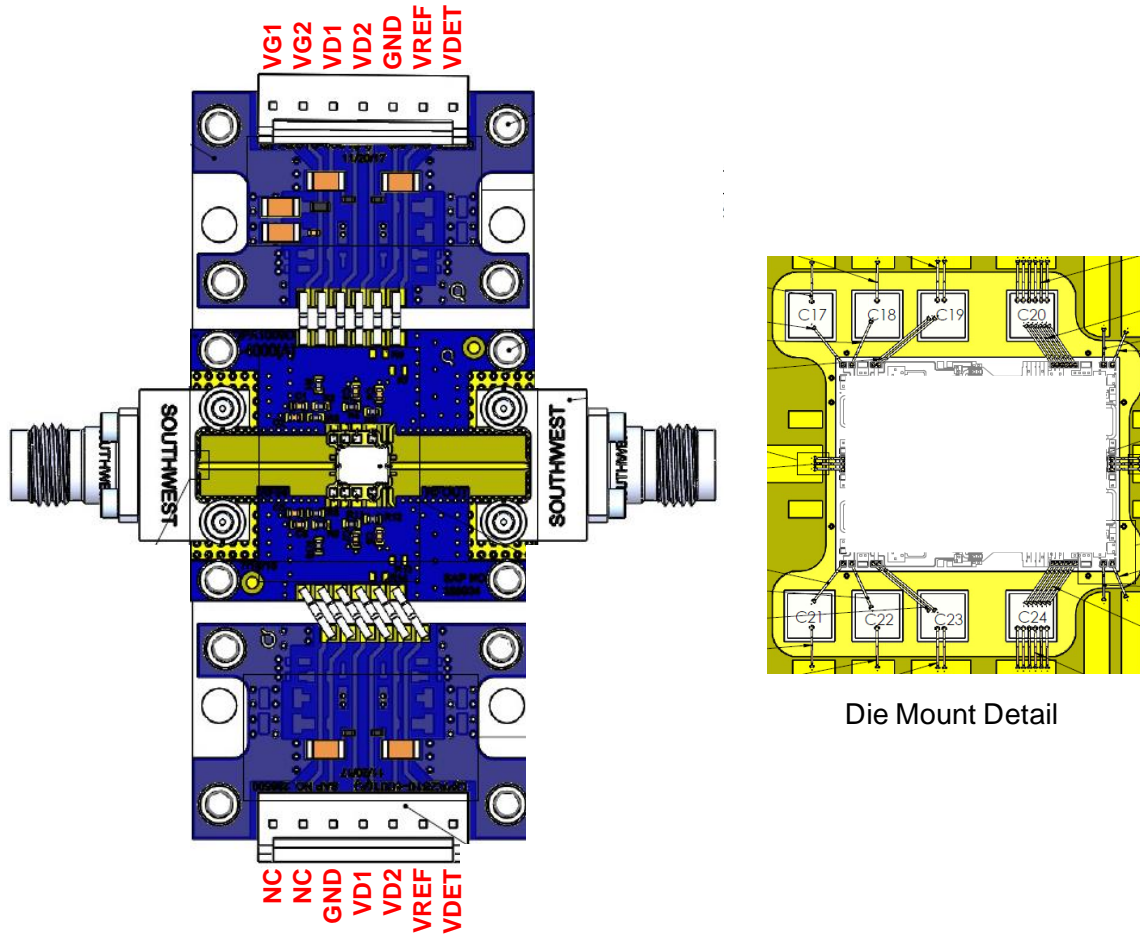

PCB is made from Rogers RO6035HTC dielectric, .010 inch thick, 0.5 oz. copper both sides.

Bill of Materials

Reference Des.	Value	Description	Manuf.	Part Number
C1, C2, C3, C4, C5, C6, C7, C8	0.01 uF	CAP, 0.01uF, 10%, 50V, X7R, 0402	Various	
C9, C10, C11, C12, C13, C14	10 uF	CAP, 10uF, 20%, 50V, 20%, X5R, 1206	Various	
C17, C18, C19, C20, C21, C22, C23, C24	820 pF	CAP, 820pF, 10%, 50V, SL, BORDER	Various	
R1, R10, R15	5.1 Ω	RES, 5.1 OHM, 5%, 50V, 0402	Various	
R2,R3,R4,R5,R8,R9,R11,R12,R17,R18,R21,R22	0 Ω	RES, 0 OHM, JMPR, 0402	Various	
R16	5.1 Ω	RES, 5.1 OHM, 1%, 1/10W, 0603	Various	
J1, J2	2.92 mm	CONNECTOR, FEMALE, ENDLAUNCH	Southwest Microwave	1092-01A-5

Mechanical Information

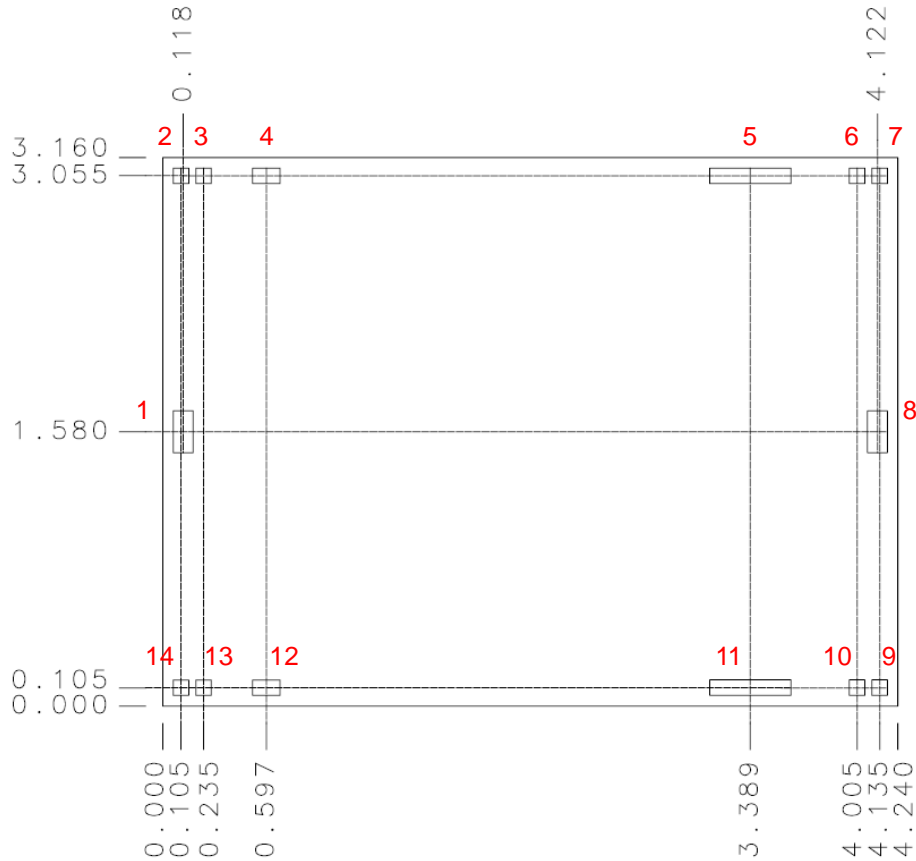

Dimensions are in mm
 Thickness: 0.100
 Die x, y size tolerance: ± 0.050
 Ground is backside of die

Bond Pad Description

Pad No.	Symbol	Description	Pad Size (um x um)
1	RF IN	RF input. 50 Ohms. DC shorted to ground.	115 x 240
2, 14	VG1	Gate voltage, stages 1 and 2. Bypass network required; see page 13.	90 x 90
3, 13	VG2	Gate voltage, stage 3. Bypass network required; see page 13.	90 x 90
4, 12	VD1	Drain voltage, stage 1. Bypass network required; see page 13.	158 x 90
5, 11	VD2	Drain voltage, stage 2. Bypass network required; see page 13.	418 x 90
6, 10	VREF	Detector reference voltage.	90 x 90
7, 9	VDET	Detector voltage.	90 x 90
8	RF OUT	RF output. 50 Ohms. AC coupled.	115 x 240

Assembly Notes

Component placement and adhesive attachment assembly notes:

- Vacuum pencils and/or vacuum collets are the preferred method of pick up.
- Air bridges must be avoided during placement.
- The force impact is critical during auto placement.

Reflow process assembly notes:

- Use AuSn (80/20) solder and limit exposure to temperatures above 300 °C for 30 seconds, maximum.
- An alloy station or conveyor furnace with reducing atmosphere should be used.
- Do not use any kind of flux.
- Coefficient of thermal expansion matching is critical for long-term reliability.
- Devices must be stored in a dry nitrogen atmosphere.

Interconnect process assembly notes:

- Thermosonic ball bonding is the preferred interconnect technique.
- Force, time, and ultrasonic are critical parameters.
- Aluminum wire should not be used.
- Devices with small pad sizes should be bonded with 0.0007-inch wire.

Handling Precautions

Parameter	Rating	Standard
ESD – Human Body Model (HBM)	1A	ANSI/ESD/JEDEC JS-001



Caution!

ESD-Sensitive Device

Solderability

Use only AuSn (80/20) solder, and limit exposure to temperatures above 300 °C to 30 seconds, maximum.

RoHS Compliance

This part is compliant with 2011/65/EU RoHS directive (Restrictions on the Use of Certain Hazardous Substances in Electrical and Electronic Equipment) as amended by Directive 2015/863/EU.

This product also has the following attributes:

- Lead Free
- Halogen Free (Chlorine, Bromine)
- Antimony Free
- TBBP-A (C₁₅H₁₂Br₄O₂) Free
- PFOS Free
- SVHC Free

Contact Information

For the latest specifications, additional product information, worldwide sales and distribution locations:

Web: www.qorvo.com

Tel: 1-844-890-8163

Email: customer.support@qorvo.com

Important Notice

The information contained herein is believed to be reliable; however, Qorvo makes no warranties regarding the information contained herein and assumes no responsibility or liability whatsoever for the use of the information contained herein. All information contained herein is subject to change without notice. Customers should obtain and verify the latest relevant information before placing orders for Qorvo products. The information contained herein or any use of such information does not grant, explicitly or implicitly, to any party any patent rights, licenses, or any other intellectual property rights, whether with regard to such information itself or anything described by such information. **THIS INFORMATION DOES NOT CONSTITUTE A WARRANTY WITH RESPECT TO THE PRODUCTS DESCRIBED HEREIN, AND QORVO HEREBY DISCLAIMS ANY AND ALL WARRANTIES WITH RESPECT TO SUCH PRODUCTS WHETHER EXPRESS OR IMPLIED BY LAW, COURSE OF DEALING, COURSE OF PERFORMANCE, USAGE OF TRADE OR OTHERWISE, INCLUDING THE IMPLIED WARRANTIES OF MERCHANTABILITY AND FITNESS FOR A PARTICULAR PURPOSE.**

Without limiting the generality of the foregoing, Qorvo products are not warranted or authorized for use as critical components in medical, life-saving, or life-sustaining applications, or other applications where a failure would reasonably be expected to cause severe personal injury or death.

Copyright 2021 © Qorvo, Inc. | Qorvo is a registered trademark of Qorvo, Inc.

Mouser Electronics

Authorized Distributor

Click to View Pricing, Inventory, Delivery & Lifecycle Information:

[Qorvo:](#)

[QPA1009D](#) [QPA1009D EVB](#)