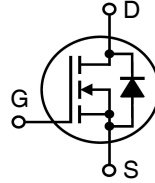


**Polar3™ HiPerFET™  
Power MOSFET**

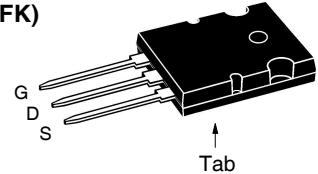
**IXFK150N30P3  
IXFX150N30P3**

**V<sub>DSS</sub> = 300V**  
**I<sub>D25</sub> = 150A**  
**R<sub>DS(on)</sub> ≤ 19mΩ**  
**t<sub>rr</sub> ≤ 250ns**

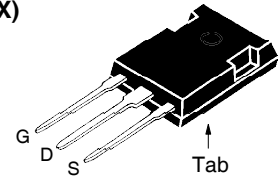
N-Channel Enhancement Mode  
 Avalanche Rated  
 Fast Intrinsic Diode



**TO-264  
(IXFK)**



**PLUS247  
(IXFX)**



G = Gate      D = Drain  
 S = Source    Tab = Drain

Symbol	Test Conditions	Maximum Ratings	
V <sub>DSS</sub>	T <sub>J</sub> = 25°C to 150°C	300	V
V <sub>DGR</sub>	T <sub>J</sub> = 25°C to 150°C, R <sub>GS</sub> = 1MΩ	300	V
V <sub>GSS</sub>	Continuous	± 20	V
V <sub>GSM</sub>	Transient	± 30	V
I <sub>D25</sub>	T <sub>C</sub> = 25°C	150	A
I <sub>DM</sub>	T <sub>C</sub> = 25°C, Pulse Width Limited by T <sub>JM</sub>	375	A
I <sub>A</sub>	T <sub>C</sub> = 25°C	75	A
E <sub>AS</sub>	T <sub>C</sub> = 25°C	4	J
P <sub>D</sub>	T <sub>C</sub> = 25°C	1300	W
dv/dt	I <sub>S</sub> ≤ I <sub>DM</sub> , V <sub>DD</sub> ≤ V <sub>DSS</sub> , T <sub>J</sub> ≤ 150°C	35	V/ns
T <sub>J</sub>		-55 ... +150	°C
T <sub>JM</sub>		150	°C
T <sub>stg</sub>		-55 ... +150	°C
T <sub>L</sub>	Maximum Lead Temperature for Soldering	300	°C
T <sub>SOLD</sub>	1.6 mm (0.062in.) from Case for 10s	260	°C
M <sub>d</sub>	Mounting Torque (TO-264)	1.13/10	Nm/lb.in
F <sub>C</sub>	Mounting Force (PLUS247)	20..120 / 4.5..27	N/lb
Weight	TO-264	10	g
	PLUS247	6	g

**Features**

- Dynamic dv/dt Rating
- Avalanche Rated
- Fast Intrinsic Diode
- Low Q<sub>G</sub>
- Low R<sub>DS(on)</sub>
- Low Drain-to-Tab Capacitance
- Low Package Inductance

**Advantages**

- Easy to Mount
- Space Savings

**Applications**

- DC-DC Converters
- Battery Chargers
- Switch-Mode and Resonant-Mode Power Supplies
- Uninterrupted Power Supplies
- AC Motor Drives
- High Speed Power Switching Applications

Symbol	Test Conditions (T <sub>J</sub> = 25°C Unless Otherwise Specified)	Characteristic Values		
		Min.	Typ.	Max.
BV <sub>DSS</sub>	V <sub>GS</sub> = 0V, I <sub>D</sub> = 3mA	300		V
V <sub>GS(th)</sub>	V <sub>DS</sub> = V <sub>GS</sub> , I <sub>D</sub> = 8mA	3.0		5.0 V
I <sub>GSS</sub>	V <sub>GS</sub> = ± 20V, V <sub>DS</sub> = 0V			± 200 nA
I <sub>DSS</sub>	V <sub>DS</sub> = V <sub>DSS</sub> , V <sub>GS</sub> = 0V T <sub>J</sub> = 125°C			25 μA 1 mA
R <sub>DS(on)</sub>	V <sub>GS</sub> = 10V, I <sub>D</sub> = 0.5 • I <sub>D25</sub> , Note 1			19 mΩ

Symbol	Test Conditions ( $T_J = 25^\circ\text{C}$ Unless Otherwise Specified)	Characteristic Values		
		Min.	Typ.	Max.
$g_{fs}$	$V_{DS} = 10\text{V}, I_D = 60\text{A}$ , Note 1	65	110	S
$C_{iss}$	$V_{GS} = 0\text{V}, V_{DS} = 25\text{V}, f = 1\text{MHz}$		12.1	nF
$C_{oss}$			1910	pF
$C_{rss}$			40	pF
$R_{Gi}$	Gate Input Resistance		1.0	$\Omega$
$t_{d(on)}$	<b>Resistive Switching Times</b> $V_{GS} = 10\text{V}, V_{DS} = 0.5 \cdot V_{DSS}, I_D = 0.5 \cdot I_{D25}$ $R_G = 1\Omega$ (External)		44	ns
$t_r$			30	ns
$t_{d(off)}$			74	ns
$t_f$			12	ns
$Q_{g(on)}$	$V_{GS} = 10\text{V}, V_{DS} = 0.5 \cdot V_{DSS}, I_D = 0.5 \cdot I_{D25}$		197	nC
$Q_{gs}$			70	nC
$Q_{gd}$			65	nC
$R_{thJC}$				0.096 $^\circ\text{C/W}$
$R_{thCS}$		0.15		$^\circ\text{C/W}$

#### Source-Drain Diode

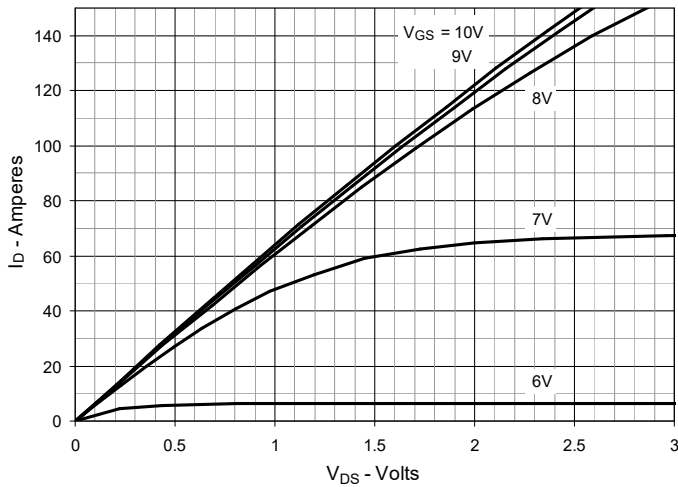
Symbol	Test Conditions ( $T_J = 25^\circ\text{C}$ , Unless Otherwise Specified)	Characteristic Values		
		Min.	Typ.	Max.
$I_S$	$V_{GS} = 0\text{V}$			150 A
$I_{SM}$	Repetitive, Pulse Width Limited by $T_{JM}$			600 A
$V_{SD}$	$I_F = 100\text{A}, V_{GS} = 0\text{V}$ , Note 1			1.5 V
$t_{rr}$	$I_F = 75\text{A}, -di/dt = 100\text{A}/\mu\text{s}$ $V_R = 100\text{V}, V_{GS} = 0\text{V}$			250 ns
$Q_{RM}$			2.9	$\mu\text{C}$
$I_{RM}$			23.0	A

Note 1. Pulse test,  $t \leq 300\mu\text{s}$ , duty cycle,  $d \leq 2\%$ .

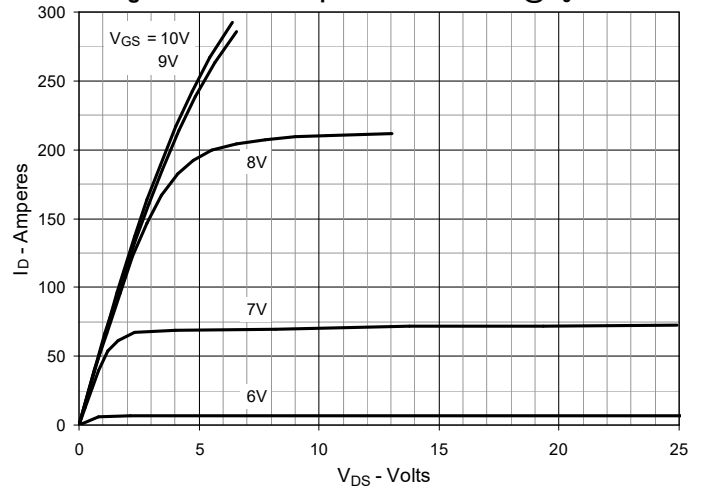
IXYS Reserves the Right to Change Limits, Test Conditions, and Dimensions.

IXYS MOSFETs and IGBTs are covered 4,835,592 4,931,844 5,049,961 5,237,481 6,162,665 6,404,065 B1 6,683,344 6,727,585 7,005,734 B2 7,157,338B2  
 by one or more of the following U.S. patents: 4,860,072 5,017,508 5,063,307 5,381,025 6,259,123 B1 6,534,343 6,710,405 B2 6,759,692 7,063,975 B2  
 4,881,106 5,034,796 5,187,117 5,486,715 6,306,728 B1 6,583,505 6,710,463 6,771,478 B2 7,071,537

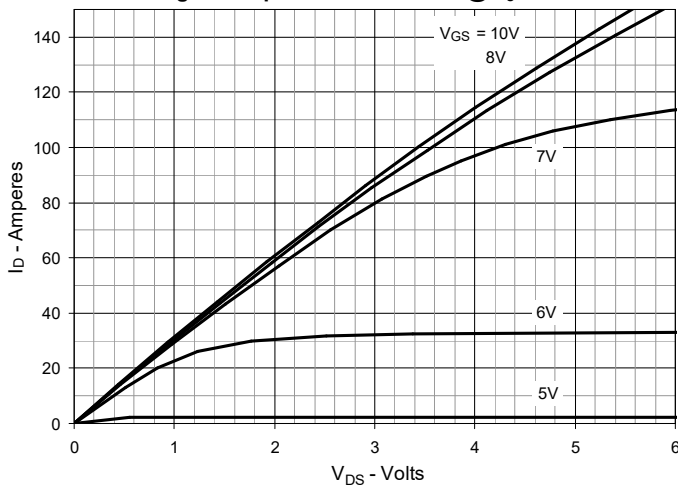
**Fig. 1. Output Characteristics @  $T_J = 25^\circ\text{C}$**



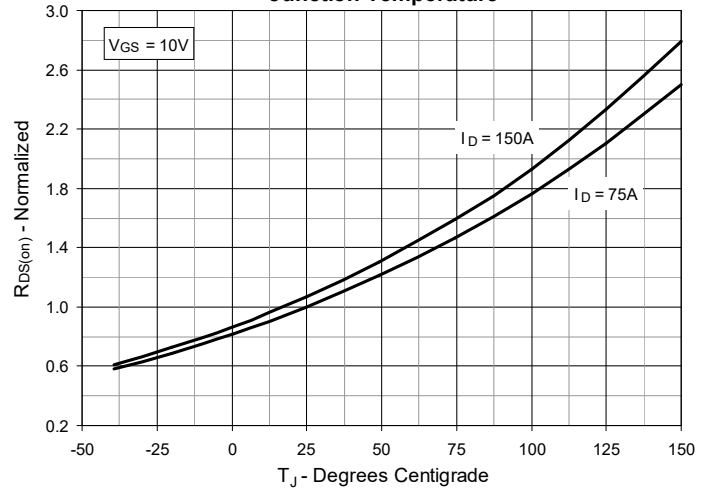
**Fig. 2. Extended Output Characteristics @  $T_J = 25^\circ\text{C}$**



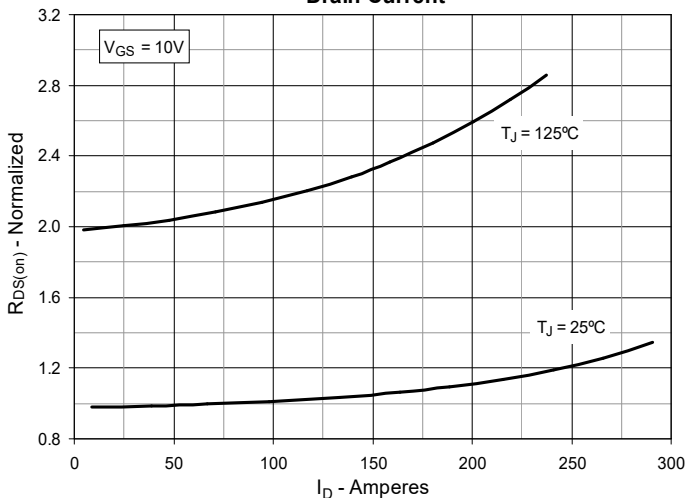
**Fig. 3. Output Characteristics @  $T_J = 125^\circ\text{C}$**



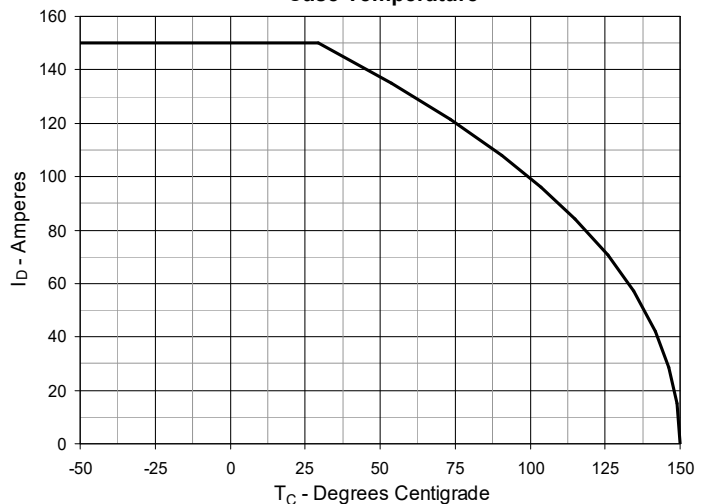
**Fig. 4.  $R_{DS(on)}$  Normalized to  $I_D = 75A$  Value vs. Junction Temperature**



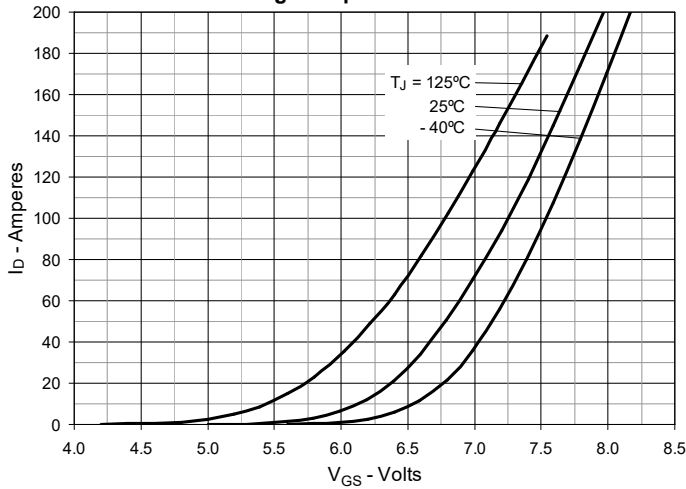
**Fig. 5.  $R_{DS(on)}$  Normalized to  $I_D = 75A$  Value vs. Drain Current**



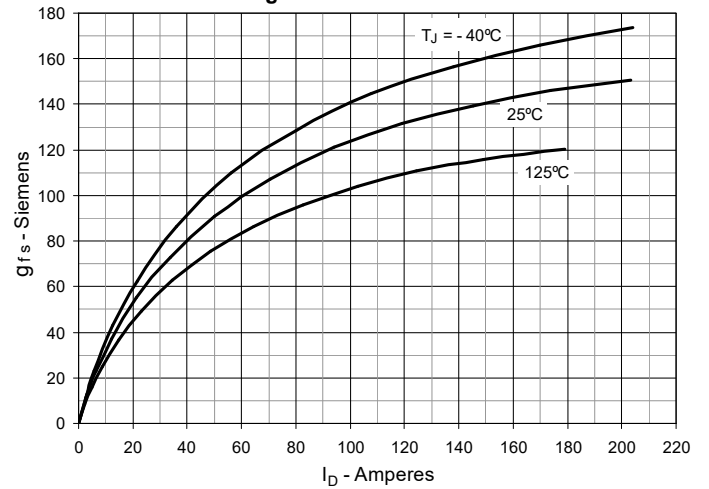
**Fig. 6. Maximum Drain Current vs. Case Temperature**



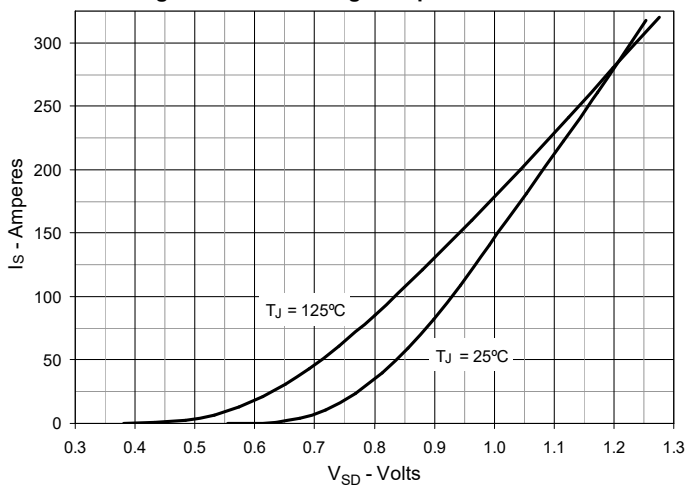
**Fig. 7. Input Admittance**



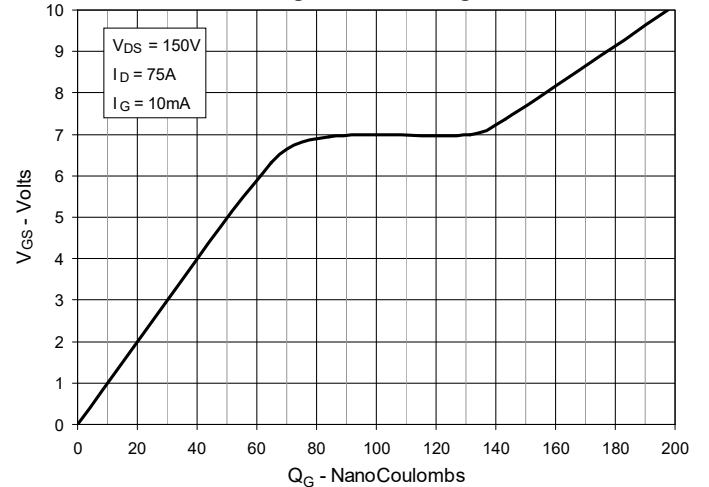
**Fig. 8. Transconductance**



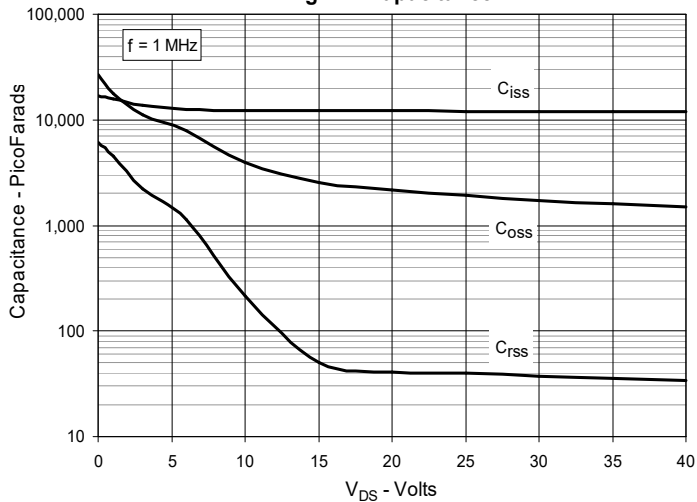
**Fig. 9. Forward Voltage Drop of Intrinsic Diode**



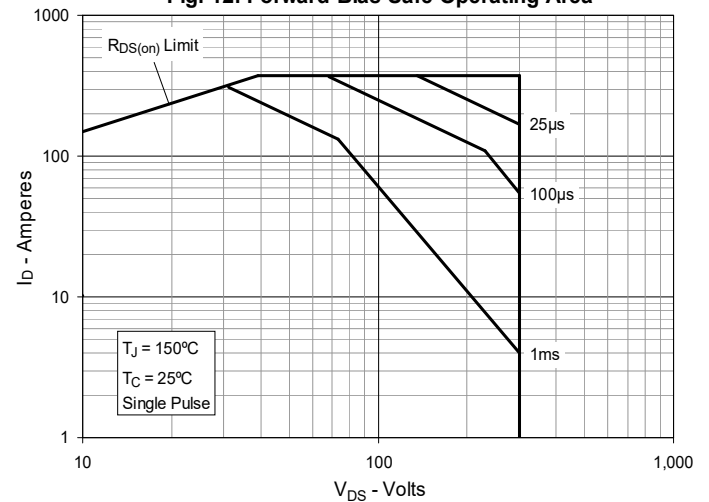
**Fig. 10. Gate Charge**



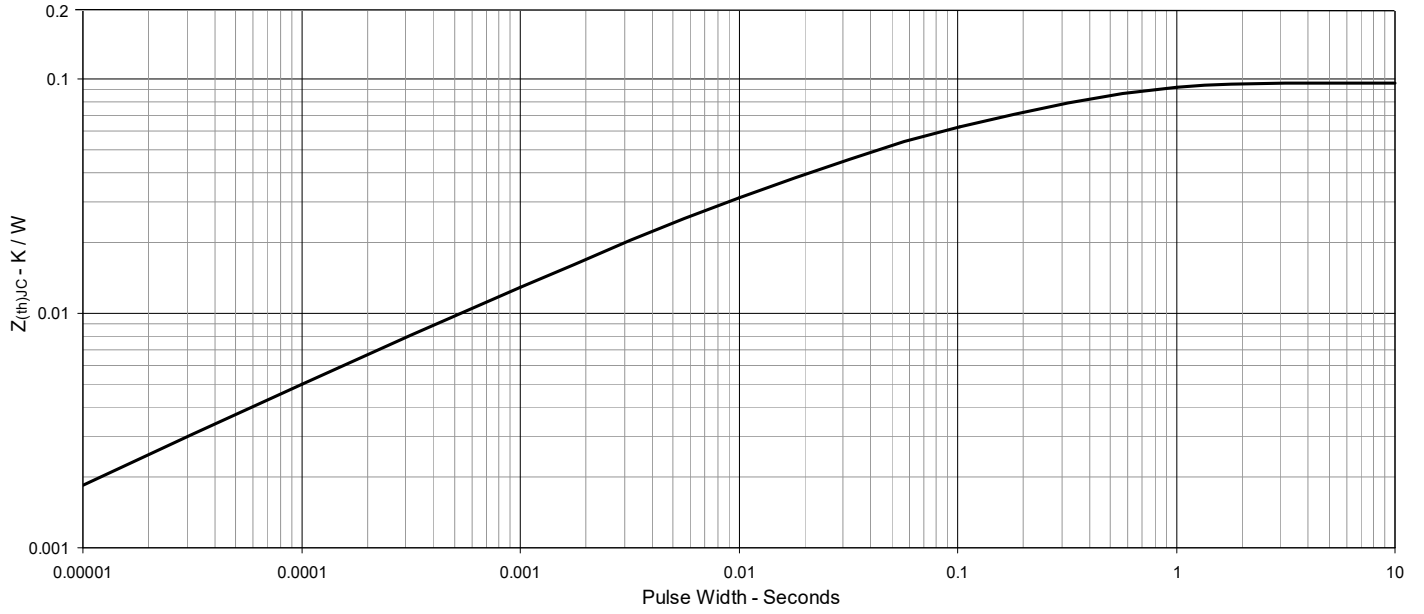
**Fig. 11. Capacitance**

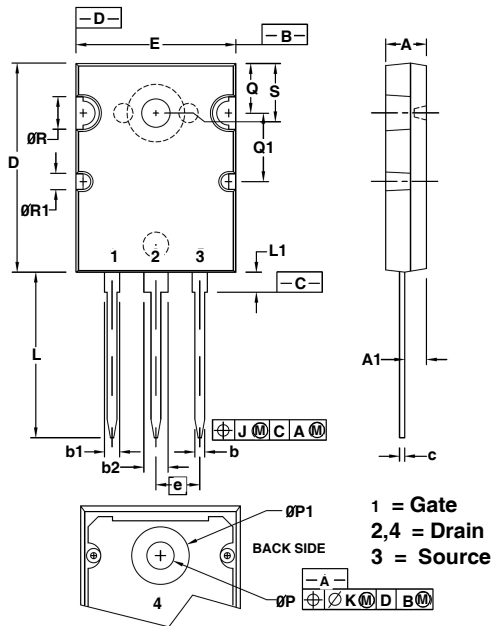


**Fig. 12. Forward-Bias Safe Operating Area**

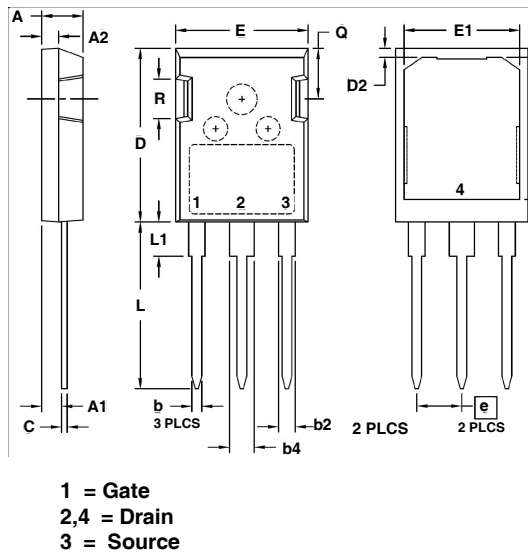


**Fig. 13. Maximum Transient Thermal Impedance**



**TO-264 Outline**


SYMBOL	INCHES		MILLIMETERS	
	MIN	MAX	MIN	MAX
A	.185	.209	4.70	5.31
A1	.102	.118	2.59	3.00
b	.037	.055	0.94	1.40
b1	.087	.102	2.21	2.59
b2	.110	.126	2.79	3.20
c	.017	.029	0.43	0.74
D	1.007	1.047	25.58	26.59
E	.760	.799	19.30	20.29
e	.215 BSC		5.46 BSC	
J	.000	.010	0.00	0.25
K	.000	.010	0.00	0.25
L	.779	.842	19.79	21.39
L1	.087	.102	2.21	2.59
∅P	.122	.138	3.10	3.51
∅P1	.270	.290	6.86	7.37
Q	.240	.256	6.10	6.50
Q1	.330	.346	8.38	8.79
∅R	.155	.187	3.94	4.75
∅R1	.085	.093	2.16	2.36
S	.243	.253	6.17	6.43

**PLUS247™ Outline**


SYM	INCHES		MILLIMETERS	
	MIN	MAX	MIN	MAX
A	.190	.205	4.83	5.21
A1	.090	.100	2.29	2.54
A2	.075	.085	1.91	2.16
b	.045	.055	1.14	1.40
b2	.075	.087	1.91	2.20
b4	.115	.126	2.92	3.20
C	.024	.031	0.61	0.80
D	.819	.840	20.80	21.34
D1	.650	.690	16.51	17.53
D2	.035	.050	0.89	1.27
E	.620	.635	15.75	16.13
E1	.520	.560	13.08	14.22
e	.215 BSC		5.45 BSC	
L	.780	.810	19.81	20.57
L1	.150	.170	3.81	4.32
Q	.220	.244	5.59	6.20
R	.170	.190	4.32	4.83



---

Disclaimer Notice - Information furnished is believed to be accurate and reliable. However, users should independently evaluate the suitability of and test each product selected for their own applications. Littelfuse products are not designed for, and may not be used in, all applications. Read complete Disclaimer Notice at [www.littelfuse.com/disclaimer-electronics](http://www.littelfuse.com/disclaimer-electronics).

---

# Mouser Electronics

Authorized Distributor

Click to View Pricing, Inventory, Delivery & Lifecycle Information:

[IXYS:](#)

[IXFK150N30P3](#) [IXFX150N30P3](#)