

# Features

# Regulated Converters

- 1.6kVDC, 2kVDC, 4kVDC or 6kVDC isolation
- Industry standard 5W DIP24 or SMD package
- Feedback regulated output
- Continuous short circuit protection
- Wide 2:1 or 4:1 input
- 3 case styles
- CTRL pin option (A pinning only)



## REC5-S(D)RW(Z)

5 Watt  
DIP24 or  
SMD Case  
Single and Dual



IEC60950-1 certified  
UL60950-1 certified  
CAN/CSA-C22.2 No. 60950-1-03 certified  
EN55032 compliant

### Description

This series offers standard isolation of 2kVDC/1s with 4kVDC/1s (= „/H4“) or 6kVDC/1s (=“/H6“) options making it ideal for both industrial, medical and other sophisticated high end applications. Packaging can be either DIP24 non-conductive plastic or 5-side-shielded DIP24 metal case (= option „/M“) as well as DIP24-SMD case (= option „/SMD“). For all the above variants, 2 industry-standard pinouts (= option „/A“ or „/C“) are available. “B” pinning is also available with “/H” isolation of 1.6kVDC. Remote on/off control is possible with the /CTRL option (“A” pinning only). The converters can deliver 140% rated power for short periods of time to cope with applications with large capacitive loads or high start up currents.

### Selection Guide

Part Number	Input Voltage Range <sup>(1)</sup> [VDC]	Output Voltage [VDC]	Output Current [mA]	Efficiency typ. <sup>(2)</sup> [%]	max. Capacitive Load <sup>(3)</sup> [µF]
REC5-xx3.3SRW	4.5-9, 9-18, 18-36, 36-72	3.3	1000	75-77	6800
REC5-xx05SRW	9-18, 18-36, 36-72 4.5-9	5	1000	79-81 75	6800
REC5-xx09SRW	9-18, 18-36, 36-72 4.5-9	9	556	82-83 73	6800
REC5-xx12SRW	9-18, 18-36, 36-72 4.5-9	12	420	84-85 74	6800
REC5-xx15SRW	9-18, 18-36, 36-72 4.5-9	15	340	85-86 75	6800
REC5-xx05DRW	9-18, 18-36, 36-72 4.5-9	±5	±500	79-81 72	±2200
REC5-xx09DRW	9-18, 18-36, 36-72 4.5-9	±9	±278	82-84 74	±2200
REC5-xx12DRW	9-18, 18-36, 36-72 4.5-9	±12	±210	84-85 75	±2200
REC5-xx15DRW	9-18, 18-36, 36-72 4.5-9	±15	±170	85-86 75	±2200
REC5-xx3.3SRWZ	9-36, 18-72	3.3	1000	75-76	6800
REC5-xx05SRWZ	9-36, 18-72	5	1000	81-82	6800
REC5-xx09SRWZ	9-36, 18-72	9	556	82-83	6800
REC5-xx12SRWZ	9-36, 18-72	12	420	83-84	6800
REC5-xx15SRWZ	9-36, 18-72	15	340	84-85	6800
REC5-xx05DRWZ	9-36, 18-72	±5	±500	81-82	±2200
REC5-xx09DRWZ	9-36, 18-72	±9	±278	82-84	±2200
REC5-xx12DRWZ	9-36, 18-72	±12	±210	82-83	±2200
REC5-xx15DRWZ	9-36, 18-72	±15	±170	84-85	±2200

#### Notes:

Note1: Refer to “Input Voltage Range”

Note2: Efficiency is tested at nominal input and full load at +25°C ambient

Note3: Max Cap Load is tested at nominal input and full resistive load

### Model Numbering



#### Notes:

- Note4: add "Z" for 4:1 Input Voltage (24= 9-36VDC or 48= 18-72VDC), without suffix= standard 2:1 input voltage range
- Note5: "H" = 1.6kVDC/1s isolation (B pinning only)  
 "H2" = 2kVDC/1s isolation (A, A/X2 or C pinning available only)  
 "H4" = 4kVDC/1s isolation (A, A/X2 or C pinning available only)  
 "H6" = 6kVDC/1s isolation (A, A/X2 or C pinning available only)
- Note6: "A"= A pinning; "B"= B pinning or "C" for C pinning. For more details please refer to "DIMENSION AND PHYSICAL CHARACTERISTICS"  
 "B" Pinning is restricted to 1.6kV isolation due to the closeness of the input and output pins.
- Note7: add suffix "M" for 5-side-shielded metal case, without suffix = 5-side-shielded non-conductive plastic case.
- Note8: add "CTRL" for control function. If CTRL is not used, pin 1 is omitted for THT version. (option for "A"-pinning only)
- Note9: add suffix "SMD" for SMD package, without suffix = standard DIP24 THT package. (If the options "M" and "SMD" are combined, the maximum allowed isolation voltage is 2kVDC/1s because of the shorter distance between pins and the metal case; DIP24 THT case and SMD plastic case are not affected and offer the full isolation barriers of 2kVDC/1s through to 6kVDC)
- Note10: add suffix "-R" for tape and reel packaging, without suffix standard tube packaging. (tape and reel option only available for SMD case style)

#### Ordering Examples:

REC5-0505SRW/H4/A/M/CTRL	4.5-9Vin	5Vout	Single output	2:1 input	4kVDC isolation	A pinning	metal case	with CTRL Pin	THT	tube packaging
REC5-2412DRWZ/H2/C/SMD-R	9-36Vin	±12Vout	Dual output	4:1 input	2kVDC isolation	C pinning	plastic case	no CTRL function	SMD	tape and reel packaging
REC5-1212SRWZ/H/B/M	9-36Vin	12Vout	Single Output	4:1 input	6kVDC isolation	B pinning	metal case	no CTRL Pin	THT	tube packaging
REC5-1215DRW/H/B/M/SMD-R	9-18Vin	±15Vout	Dual Output	2:1 input	1.6kVDC isolation	B pinning	metal case	no CTRL function	SMD	tape and reel packaging

### Specifications (measured @ Ta= 25°C, nom. Vin, full load and after warm-up unless otherwise stated)

BASIC CHARACTERISTICS						
Parameter	Condition			Min.	Typ.	Max.
Internal Input Filter						Pi Network
Input Voltage Range	2:1 Input	nom. Vin=	5VDC	4.5VDC		9VDC
			12VDC	9VDC		18VDC
			24VDC	18VDC		36VDC
			48VDC	36VDC		72VDC
	4:1 Input („Z“)	nom. Vin=	24VDC	9VDC		36VDC
			48VDC	18VDC		72VDC
Input Surge Voltage	100ms max.	nom. Vin=	5VDC			16VDC
			12VDC			25VDC
			24VDC			50VDC
			48VDC			100VDC
Minimum Load <sup>(11)</sup>				10%		
No Load Power Consumption						300mW
ON/OFF CTRL <sup>(12)</sup>	DC-DC ON			Open or 0V < V <sub>CTRL</sub> < 1.2V		
	DC-DC OFF			Short or 2.2V < V <sub>CTRL</sub> < 12VDC		
Internal Operating Frequency	2:1 Input			120kHz		
	4:1 Input			200kHz		
Output Ripple and Noise <sup>(13)</sup>	20MHz BW					50mVp-p

#### Notes:

- Note11: Operation below 10% load won't harm the converter, but specifications may not be met
- Note12: "A"-pinning only. Please refer to "ON/OFF CTRL ("A" pinning only)" for CTRL pin circuit.
- Note13: Measurements are made with a 0.1µF MLCC across output. (low ESR)

continued on next page

Specifications (measured @  $T_a = 25^\circ\text{C}$ , nom.  $V_{in}$ , full load and after warm-up unless otherwise stated)

Efficiency vs. Load

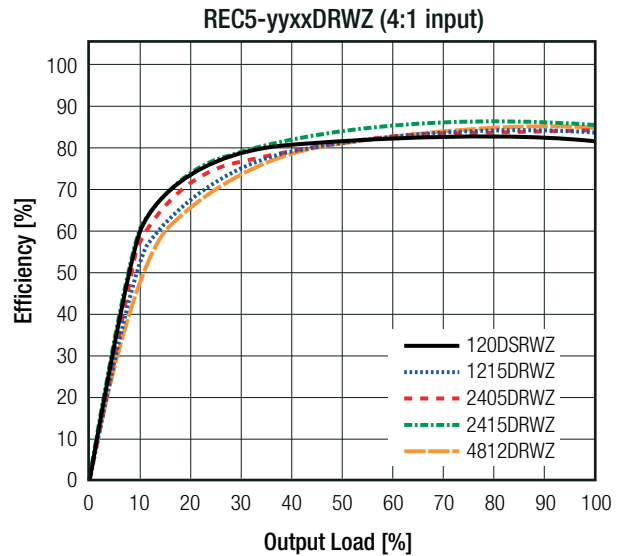
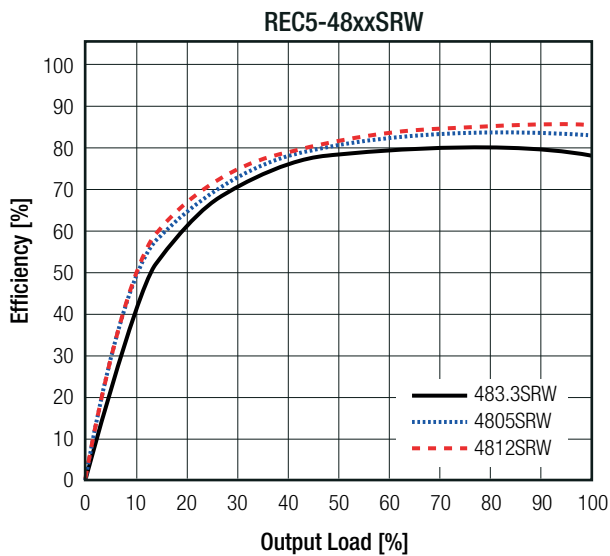
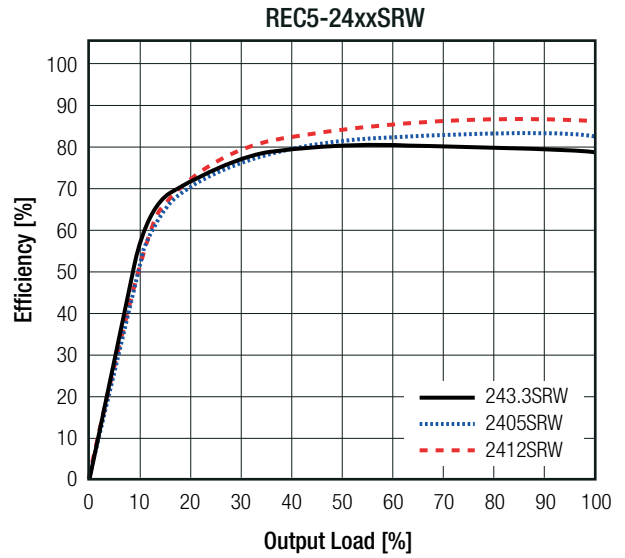
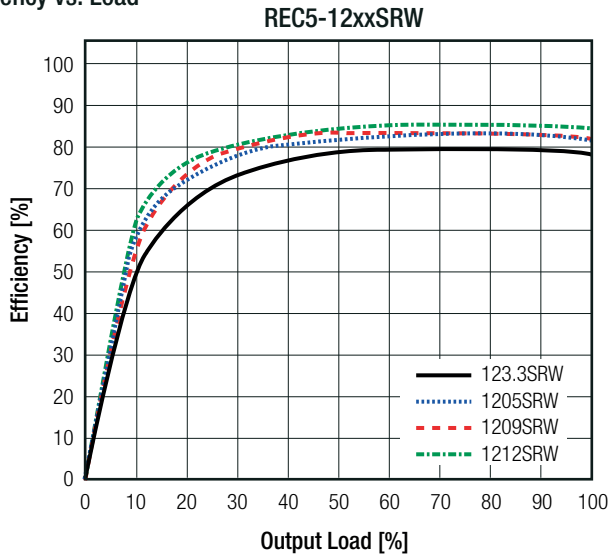

### ON/OFF CTRL ("A" pinning only)

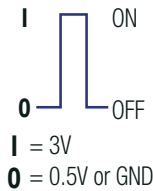
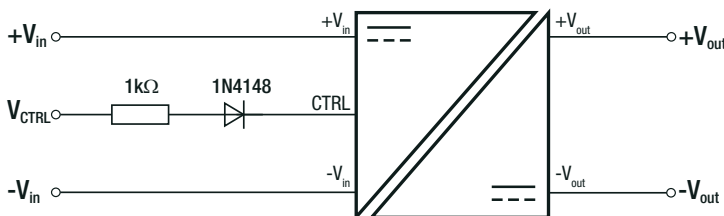

DC-DC ON: Open or  $0V < V_{CTRL} < 1.2VDC$   
 DC-DC OFF: Short or  $2.2V < V_{CTRL} < 12VDC$

### REGULATIONS

Parameter	Condition	Value
Output Accuracy		$\pm 2.0\%$ max.
Line Regulation	low line to high line	$\pm 0.3\%$ max.
Load Regulation	20% to 100% load	$\pm 0.6\%$ max.

**Specifications** (measured @ Ta= 25°C, nom. Vin, full load and after warm-up unless otherwise stated)

**PROTECTIONS**

Parameter	Type	Value	
Short Circuit Protection (SCP) <sup>(14)</sup>	below 100mΩ	continuous, auto recovery	
Isolation Voltage <sup>(15)</sup>	with suffix "/H"	tested for 1 second	1.6kVDC
		rated for 1 minute	500VAC/60Hz
	with suffix "/H2"	tested for 1 second	2kVDC
		rated for 1 minute	1kVAC/60Hz
	with suffix "/H3"	tested for 1 second	4kVDC
		rated for 1 minute	2kVAC/60Hz
with suffix "/H6"	tested for 1 second	6kVDC	
	rated for 1 minute	3kVAC/60Hz	
Isolation Resistance		1GΩ min.	
Isolation Capacitance		60pF typ.	
Insulation Grade		functional	

**Notes:**

Note14: Max. Temperature = +50°C during the short circuit conditions.

Note15: For repeat Hi-Pot testing, reduce the time and/or the test voltage

Note16: Refer to local safety regulations if input over-current protection is also required. Recommended fuse: slow blow type

**ENVIRONMENTAL**

Parameter	Condition	Value	
Operating Temperature Range	with derating @ free air convection (refer to <i>"Derating Graph"</i> )	-40°C to +105°C	
Thermal Impedance	plastic case	20K/W	
	metal case	12K/W	
Operating Altitude		2000m	
Operating Humidity	non-condensing	95% RH max.	
Pollution Degree		PD2	
MTBF	according to MIL-HDBK-217F, G.B.	+25°C	850 x 10 <sup>3</sup> hours
		+75°C	206 x 10 <sup>3</sup> hours

**Derating Graph**

(@ Chamber and free air convection 0.1m/s)

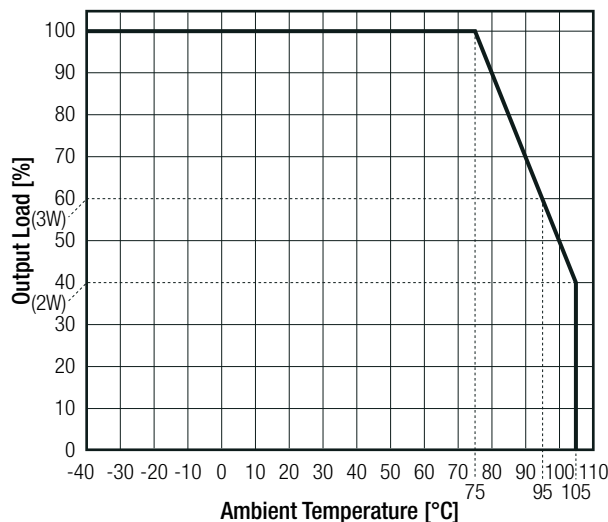

**Specifications** (measured @ Ta= 25°C, nom. Vin, full load and after warm-up unless otherwise stated)

### SAFETY AND CERTIFICATIONS

Certificate Type (Safety)	Report / File Number	Standard
Information Technology Equipment, General Requirements for Safety	E358085	UL60950-1, 1st Edition, 2007 CAN/CSA-C22.2 No. 60950-1-03, 1st Edition, 2006
Information Technology Equipment, General Requirements for Safety	LVD1605077-10	IEC60950-1:2005, 2nd Edition + A2:2013
Medical Electric Equipment, General Requirements for Safety and Essential Performance	WD-SE-R-180675-A0	IEC60601-1:2005, 3rd Edition, + A1:2012 EN60601-1:2006 + A12:2014
EAC	RU-AT.AB49.B.09571	TP TC 004/2011
RoHS2	TWNC00677039	RoHS, 2011/65/EU + AM-2015/863

### EMC Compliance

Condition	Standard / Criterion
Electromagnetic compatibility of multimedia equipment - Emission requirements <sup>(17)</sup>	with external filter (see filter suggestion below)
	EN55032, Class A/B

### EMC Filtering Suggestions according to EN55032

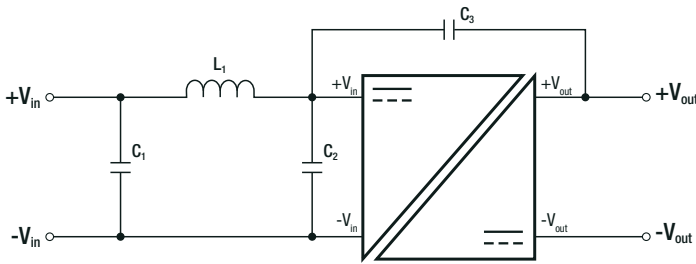

#### Component List Class A

MODEL	C1	C2	C3	L1
REC5-0505SRW/H4/A	N/A	10µF MLCC	150pF	N/A
REC5-1205SRW/H4/A				<a href="#">12µH RLS-126</a>
REC5-2405SRW/H4/A			330pF	<a href="#">22µH RLS-226</a>
REC5-4805SRW/H2/A				

#### Component List Class B

MODEL	C1	C2	C3	L1
REC5-0505SRW/H4/A	10µF MLCC	10µF MLCC	150pF	<a href="#">18µH RLS-186</a>
REC5-1205SRW/H4/A				<a href="#">12µH RLS-126</a>
REC5-2405SRW/H4/A			1nF	<a href="#">22µH RLS-226</a>
REC5-4805SRW/H2/A				<a href="#">100µH RLS-105</a>

#### Notes:

Note17: Filter suggestions are valid for indicated part numbers only. For other part numbers, please contact Recom tech support advice

### DIMENSION AND PHYSICAL CHARACTERISTICS

Parameter	Type	Value	
Material	plastic case	non-conductive black plastic, (UL94 V-0)	
	metal case ("M" option)	nickel plated copper	
	PCB	FR4, (UL94 V-0)	
	potting	epoxy, (UL94 V-0)	
Dimension (LxWxH)	DIP24	plastic case	31.8 x 20.3 x 10.2mm
		metal case ("M" option)	32.0 x 20.3 x 10.2mm
	SMD	plastic case	31.8 x 20.3 x 10.9mm
		metal case ("M" option)	32.0 x 20.3 x 10.9mm
Weight		13g typ.	

continued on next page

**Specifications** (measured @ Ta= 25°C, nom. Vin, full load and after warm-up unless otherwise stated)

**Dimension Drawing DIP24 plastic case (mm)**

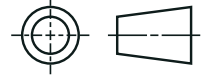

**„A“ Pinning (/H2, /H4, /H6)**

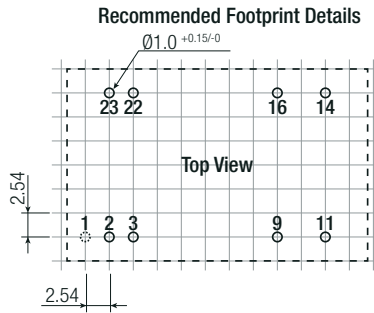
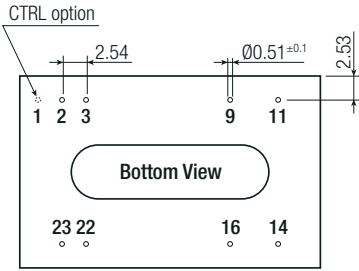
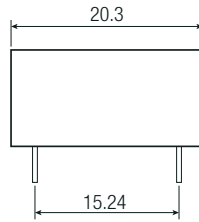
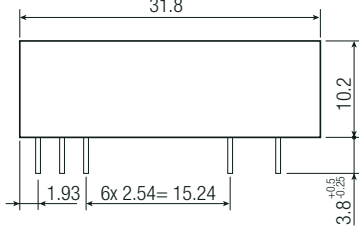

**„A“ Pinning (/H2,/H4,/H6)**

Pin #	Single	Single/X2	Dual
1 „NoteB“	CTRL	CTRL	CTRL
2,3	-Vin	-Vin	-Vin
9	NC	no pin	Com
11	NC	NC	-Vout
14	+Vout	+Vout	+Vout
16	-Vout	-Vout	Com
22,23	+Vin	+Vin	+Vin

NC= No Connection

**„B“ Pinning (/H only)**

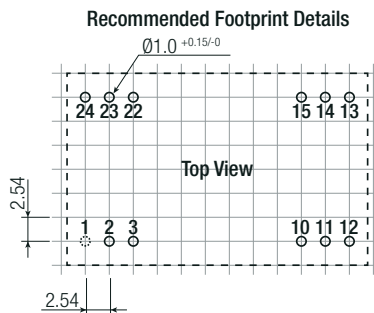
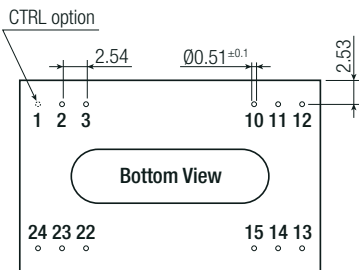
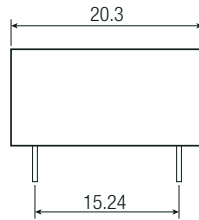
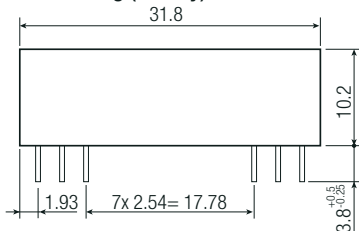

**„B“ Pinning (/H only)**

Pin #	Single	Dual
1	+Vin	+Vin
2	no pin	-Vout
3	no pin	Com
10	-Vout	Com
11,14	+Vout	+Vout
12,13	-Vin	-Vin
15	-Vout	Com
22	no pin	Com
23	no pin	-Vout
24	+Vin	+Vin

**„C“ Pinning (/H2, /H4, /H6)**

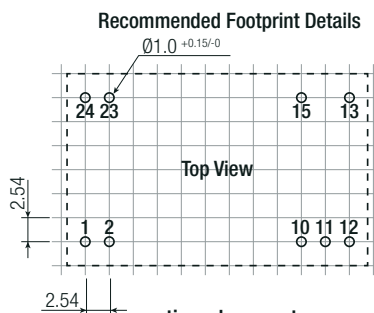
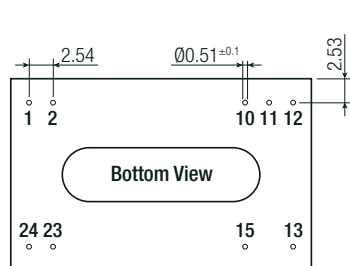
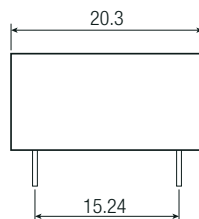
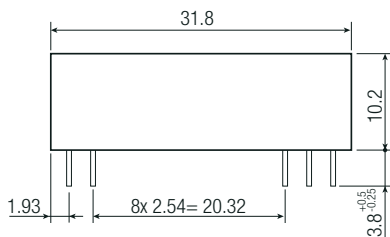

**„C“ Pinning (/H2,/H4,/H6)**

Pin #	Single	Dual
1,2	+Vin	+Vin
10,11	NC	COM
12	-Vout	NC
13	+Vout	-Vout
15	NC	+Vout
23,24	-Vin	-Vin

NC= No Connection

continued on next page

tolerance ±0.25mm

Specifications (measured @ Ta= 25°C, nom. Vin, full load and after warm-up unless otherwise stated)

Dimension Drawing SMD plastic case (mm)

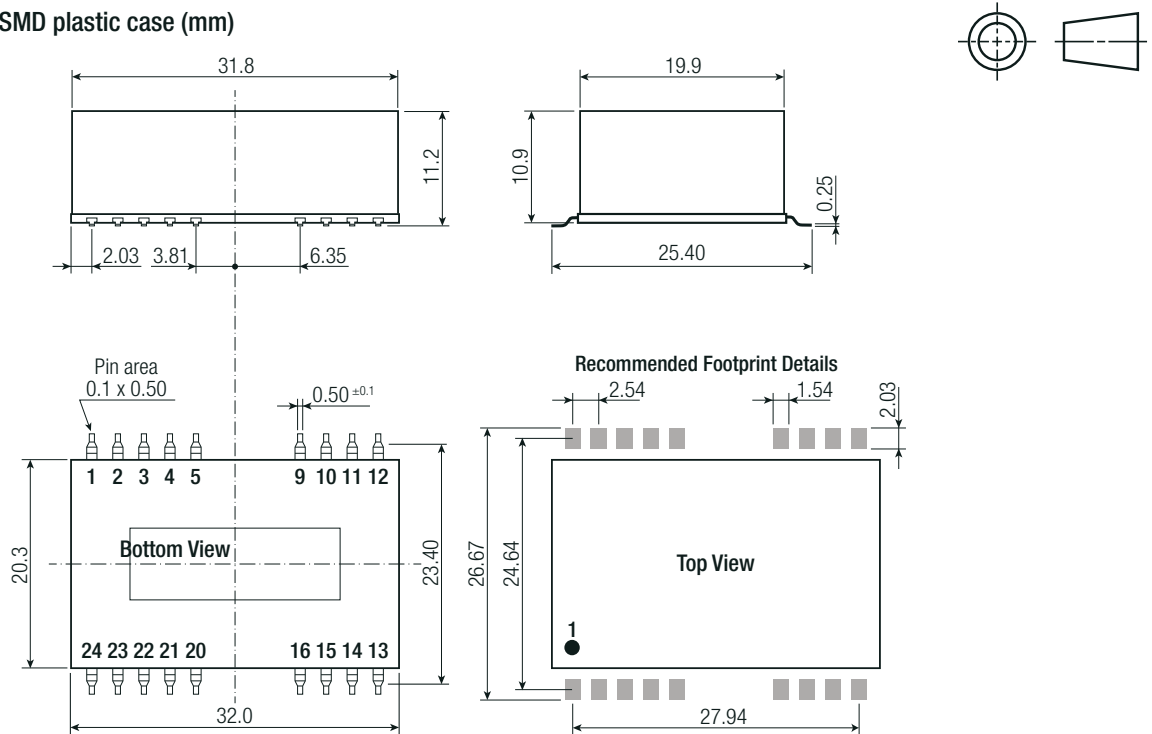

### „A“ Pinning

Pin #	Single	Dual
1 <small>„Note8“</small>	CTRL	CTRL
2,3	-Vin	-Vin
4,5	NC	NC
9	NC	Com
10,12,13,15	NC	NC
11	NC	-Vout
14	+Vout	+Vout
16	-Vout	Com
20,21,24	NC	NC
22,23	+Vin	+Vin

NC= No Connection

### „B“ Pinning

Pin #	Single	Dual
1	+Vin	+Vin
2	NC	-Vout
3	NC	Com
4,5,9	NC	NC
10	-Vout	Com
11	+Vout	+Vout
12,13	-Vin	-Vin
14	+Vout	+Vout
15	-Vout	Com
16,20,21	NC	NC
22	NC	Com
23	NC	-Vout
24	+Vin	+Vin

NC= No Connection

### „C“ Pinning

Pin #	Single	Dual
1,2	+Vin	+Vin
3,4,5,9	NC	NC
10,11	NC	Com
12	-Vout	NC
13	+Vout	-Vout
14	NC	NC
15	NC	+Vout
16,20,21,22	NC	NC
23,24	-Vin	-Vin

NC= No Connection

### Notes:

Note18: All models with plastic housings have an embossed RECOM logo. See below, top view:

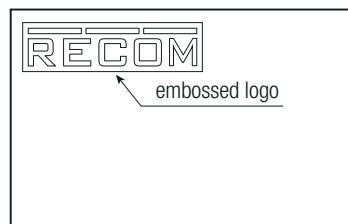

continued on next page

tolerance  $\pm 0.35$ mm

Specifications (measured @ Ta= 25°C, nom. Vin, full load and after warm-up unless otherwise stated)

Dimension Drawing DIP24 metal case (mm)

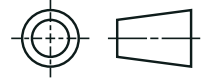

„A“ Pinning (/H2, /H4, /H6)

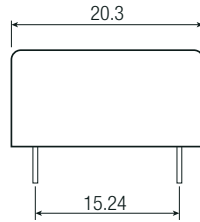
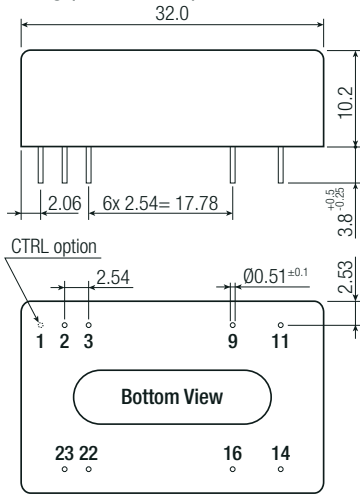

Recommended Footprint Details

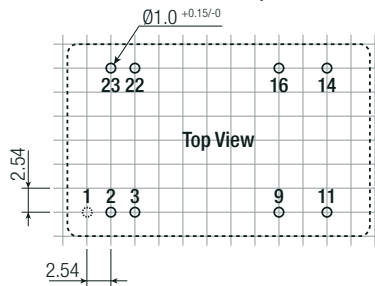

„A“ Pinning (/H2,/H4,/H6)

Pin #	Single	Single/X2	Dual
1 „Note8“	CTRL	CTRL	CTRL
2,3	-Vin	-Vin	-Vin
9	NC	no pin	Com
11	NC	NC	-Vout
14	+Vout	+Vout	+Vout
16	-Vout	-Vout	Com
22,23	+Vin	+Vin	+Vin

NC: No Connection

„B“ Pinning (/H only)

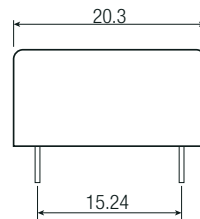
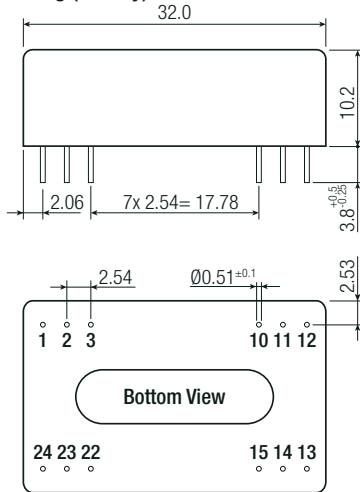

Recommended Footprint Details

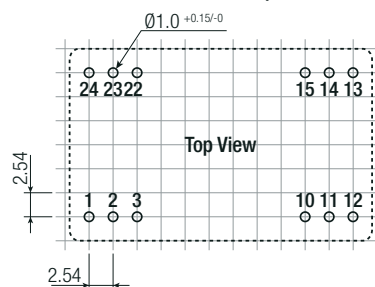

„B“ Pinning (/H only)

Pin #	Single	Dual
1	+Vin	+Vin
2	no pin	-Vout
3	no pin	Com
10	-Vout	Com
11,14	+Vout	+Vout
12,13	-Vin	-Vin
15	-Vout	Com
22	no pin	Com
23	no pin	-Vout
24	+Vin	+Vin

NC= No Connection

„C“ Pinning (/H2, /H4, /H6)

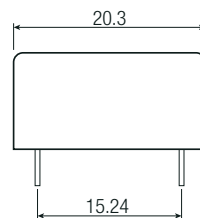
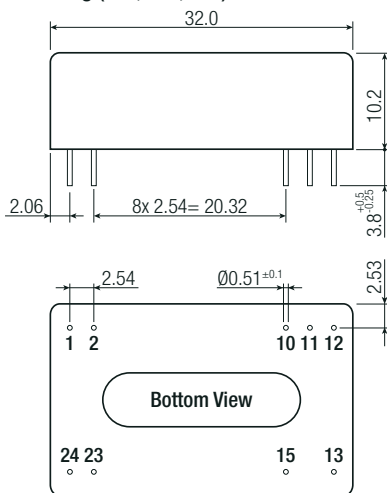

Recommended Footprint Details

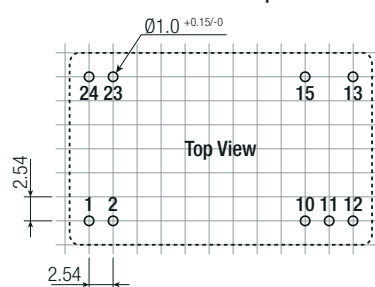

„C“ Pinning (/H2,/H4,/H6)

Pin #	Single	Dual
1,2	+Vin	+Vin
10,11	NC	COM
12	-Vout	NC
13	+Vout	-Vout
15	NC	+Vout
23,24	-Vin	-Vin

NC= No Connection

tolerance ±0.25mm

continued on next page



Specifications (measured @ Ta= 25°C, nom. Vin, full load and after warm-up unless otherwise stated)

Dimension Drawing SMD metal case (mm)

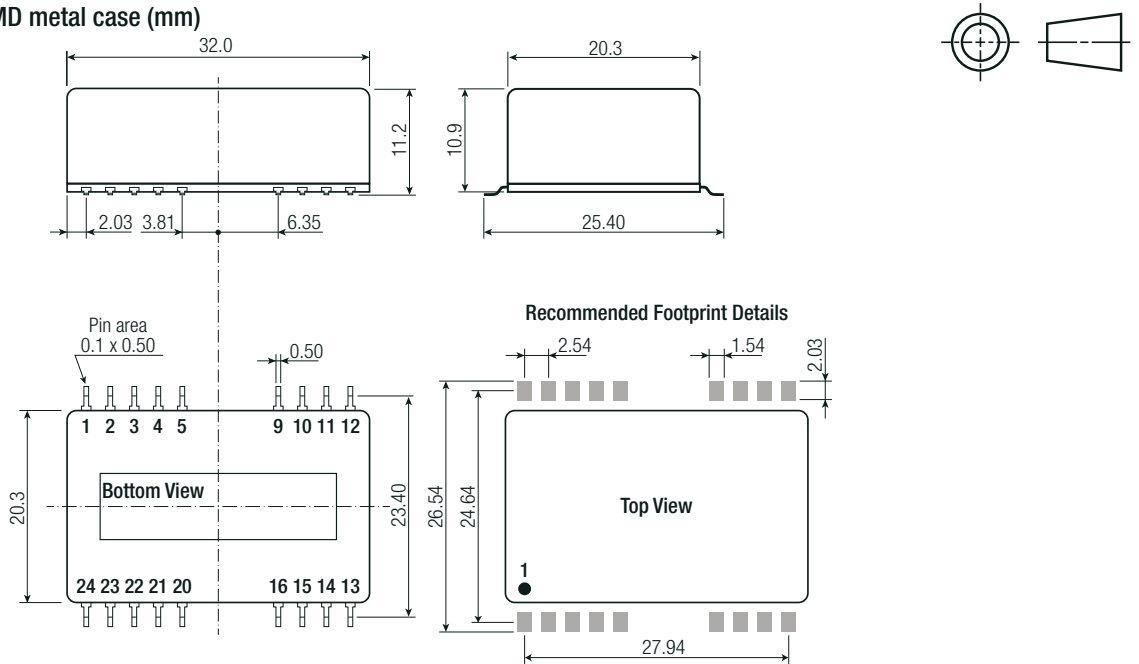

„A“ Pinning

Pin #	Single	Dual
1 „Note8“	CTRL	CTRL
2,3	-Vin	-Vin
4,5	NC	NC
9	NC	Com
10,12,13,15	NC	NC
11	NC	-Vout
14	+Vout	+Vout
16	-Vout	Com
20,21,24	NC	NC
22,23	+Vin	+Vin

NC= No Connection

„B“ Pinning

Pin #	Single	Dual
1	+Vin	+Vin
2	NC	-Vout
3	NC	Com
4,5,9	NC	NC
10	-Vout	Com
11	+Vout	+Vout
12,13	-Vin	-Vin
14	+Vout	+Vout
15	-Vout	Com
16,20,21	NC	NC
22	NC	Com
23	NC	-Vout
24	+Vin	+Vin

NC= No Connection

„C“ Pinning

Pin #	Single	Dual
1,2	+Vin	+Vin
3,4,5,9	NC	NC
10,11	NC	Com
12	-Vout	NC
13	+Vout	-Vout
14	NC	NC
15	NC	+Vout
16,20,21,22	NC	NC
23,24	-Vin	-Vin

NC= No Connection

tolerance ±0.35mm

PACKAGING INFORMATION

Parameter	Type	Value	
Packaging Dimension (LxWxH)	tube	THT	530.0 x 23.0 x 19.0mm
		SMD	530.0 x 32.0 x 19.0mm
	tape and reel (“-R” only)	355.0 x 342.0 x 70.0mm	
Tape Width		44mm	
Packaging Quantity	tube	15pcs	
	tape and reel	100pcs	
Storage Temperature Range		-55°C to +125°C	
Storage Humidity	non-condensing	95% RH max.	

The product information and specifications may be subject to changes even without prior written notice. The product has been designed for various applications; its suitability lies in the responsibility of each customer. The products are not authorized for use in safety-critical applications without RECOM's explicit written consent. A safety-critical application is an application where a failure may reasonably be expected to endanger or cause loss of life, inflict bodily harm or damage property. The applicant shall indemnify and hold harmless RECOM, its affiliated companies and its representatives against any damage claims in connection with the unauthorized use of RECOM products in such safety-critical applications.