

Ultrafast Avalanche SMD Rectifier

DO-214AC (SMA)

FEATURES

- Low profile package
- Ideal for automated placement
- Glass passivated junction
- Low reverse current
- Soft recovery characteristics
- Ultrafast reverse recovery time
- Meets MSL level 1, per J-STD-020, LF maximum peak of 260 °C
- AEC-Q101 qualified
- Material categorization: For definitions of compliance please see www.vishay.com/doc?99912

RoHS
COMPLIANT

TYPICAL APPLICATIONS

For use in high frequency rectification of power supply, inverters, converters, and freewheeling diodes for consumer, automotive and telecommunication.

MECHANICAL DATA

Case: DO-214AC (SMA)

Molding compound meets UL 94 V-0 flammability rating

Base P/N-E3 - RoHS-compliant, commercial grade

Base P/NHE3 - RoHS-compliant, AEC-Q101 qualified

Terminals: Matte tin plated leads, solderable per J-STD-002 and JESD 22-B102

E3 suffix meets JESD 201 class 2 whisker test, HE3 suffix meets JESD 201 class 2 whisker test

Polarity: Color band denotes the cathode end

PRIMARY CHARACTERISTICS	
$I_{F(AV)}$	1.5 A
V_{RRM}	200 V, 400 V, 600 V
I_{FSM}	30 A
I_R	1.0 μ A
V_F at I_F	1.4 V
t_{rr}	75 ns
E_R	20 mJ
T_J max.	150 °C
Package	DO-214AC (SMA)
Diode variations	Single die

MAXIMUM RATINGS ($T_A = 25$ °C unless otherwise noted)					
PARAMETER	SYMBOL	BYG20D	BYG20G	BYG20J	UNIT
Device marking code		BYG20D	BYG20G	BYG20J	
Maximum repetitive peak reverse voltage	V_{RRM}	200	400	600	V
Average forward current	$I_{F(AV)}$	1.5			A
Peak forward surge current 10 ms single half sine-wave superimposed on rated load	I_{FSM}	30			A
Pulse energy in avalanche mode, non repetitive (inductive load switch off) $I_{(BR)R} = 1$ A, $T_J = 25$ °C	E_R	20			mJ
Operating junction and storage temperature range	T_J, T_{STG}	-55 to +150			°C



ELECTRICAL CHARACTERISTICS ($T_A = 25\text{ }^\circ\text{C}$ unless otherwise noted)							
PARAMETER	TEST CONDITIONS		SYMBOL	BYG20D	BYG20G	BYG20J	UNIT
Maximum instantaneous forward voltage	$I_F = 1\text{ A}$	$T_J = 25\text{ }^\circ\text{C}$	$V_F^{(1)}$	1.3			V
	$I_F = 1.5\text{ A}$			1.4			
Maximum DC reverse current	$V_R = V_{RRM}$	$T_J = 25\text{ }^\circ\text{C}$	I_R	1			μA
		$T_J = 100\text{ }^\circ\text{C}$		10			
Maximum reverse recovery time	$I_F = 0.5\text{ A}, I_R = 1.0\text{ A}, I_{rr} = 0.25\text{ A}$		t_{rr}	75			ns

Note

(1) Pulse test: 300 μs pulse width, 1 % duty cycle

THERMAL CHARACTERISTICS ($T_A = 25\text{ }^\circ\text{C}$ unless otherwise noted)						
PARAMETER	SYMBOL	BYG20D	BYG20G	BYG20J	UNIT	
Typical thermal resistance, junction to lead, $T_L = \text{const.}$	$R_{\theta JL}$	25			$^\circ\text{C/W}$	
Typical thermal resistance, junction to ambient	$R_{\theta JA}^{(1)}$	150			$^\circ\text{C/W}$	
	$R_{\theta JA}^{(2)}$	125				
	$R_{\theta JA}^{(3)}$	100				

Notes

- (1) Mounted on epoxy-glass hard tissue
- (2) Mounted on epoxy-glass hard tissue, 50 mm² 35 μm Cu
- (3) Mounted on Al-oxide-ceramic (Al₂O₃), 50 mm² 35 μm Cu

ORDERING INFORMATION (Example)				
PREFERRED P/N	UNIT WEIGHT (g)	PREFERRED PACKAGE CODE	BASE QUANTITY	DELIVERY MODE
BYG20D-E3/TR	0.064	TR	1800	7" diameter plastic tape and reel
BYG20D-E3/TR3	0.064	TR3	7500	13" diameter plastic tape and reel
BYG20DHE3/TR (1)	0.064	TR	1800	7" diameter plastic tape and reel
BYG20DHE3/TR3 (1)	0.064	TR3	7500	13" diameter plastic tape and reel

Note

(1) AEC-Q101 qualified

RATINGS AND CHARACTERISTICS CURVES ($T_A = 25\text{ }^\circ\text{C}$ unless otherwise noted)

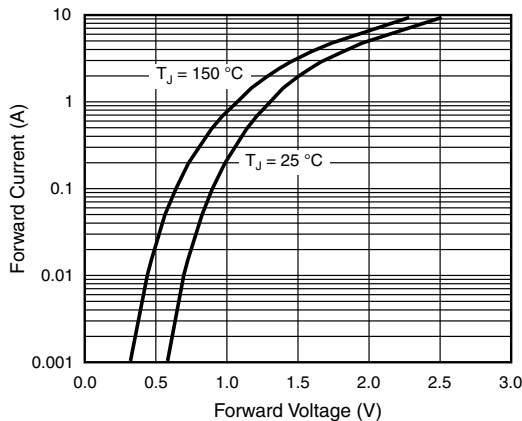

Fig. 1 - Forward Current vs. Forward Voltage

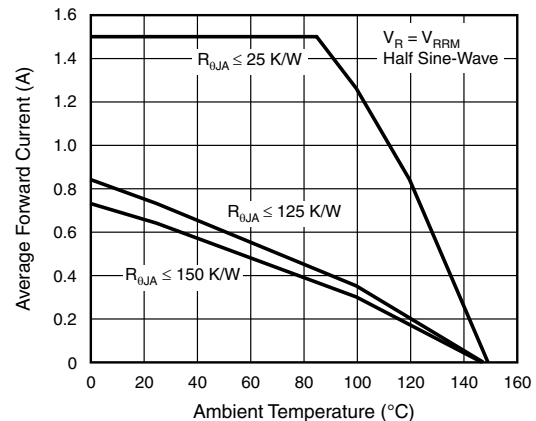

Fig. 2 - Max. Average Forward Current vs. Ambient Temperature

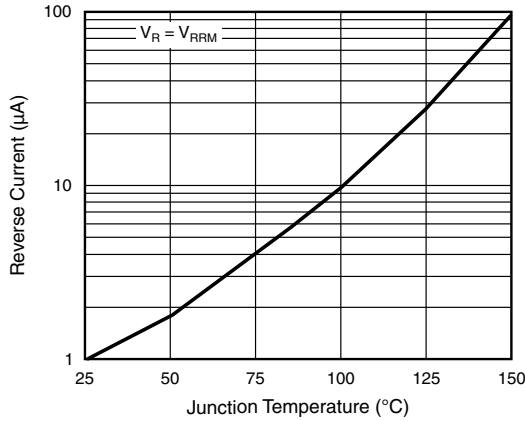

Fig. 3 - Reverse Current vs. Junction Temperature

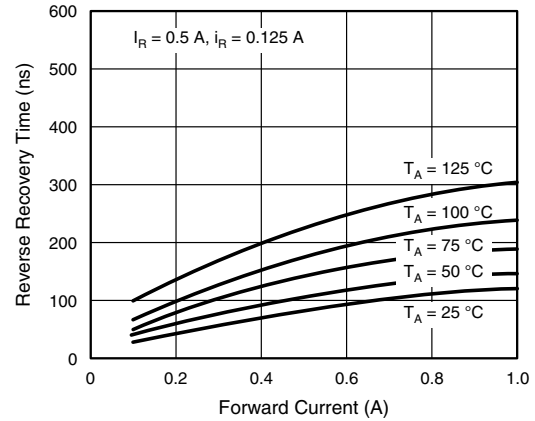

Fig. 6 - Reverse Recovery Time vs. Forward Current

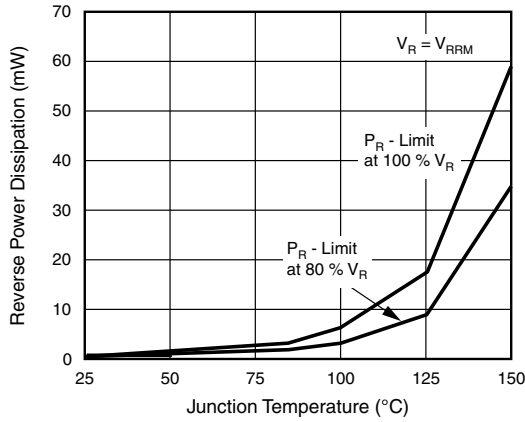

Fig. 4 - Max. Reverse Power Dissipation vs. Junction Temperature

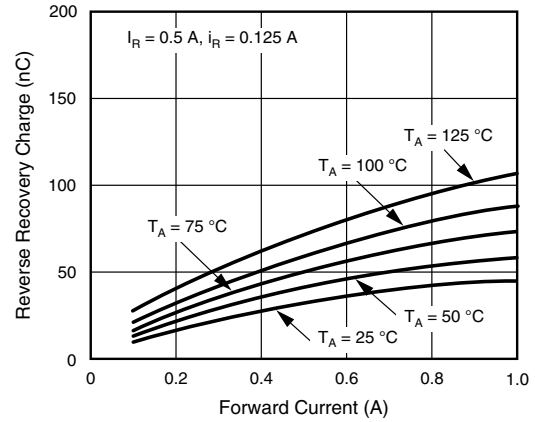

Fig. 7 - Reverse Recovery Charge vs. Forward Current

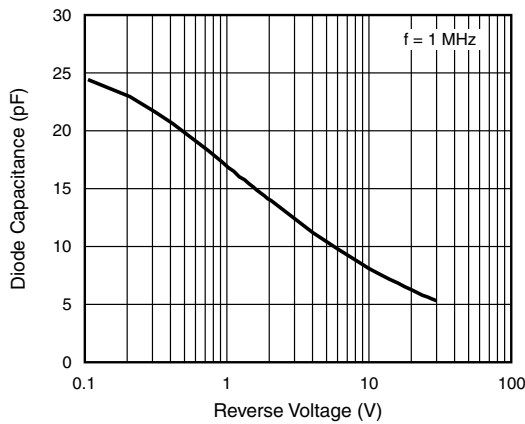

Fig. 5 - Diode Capacitance vs. Reverse Voltage

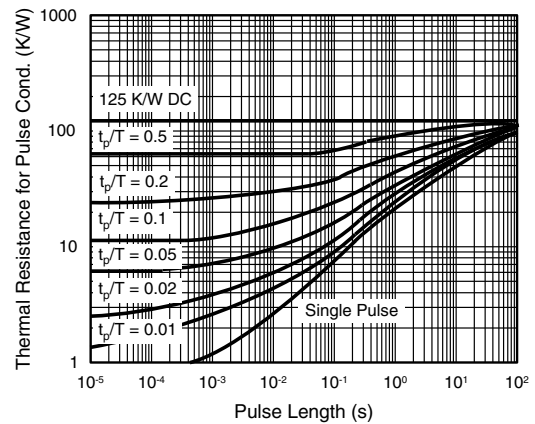
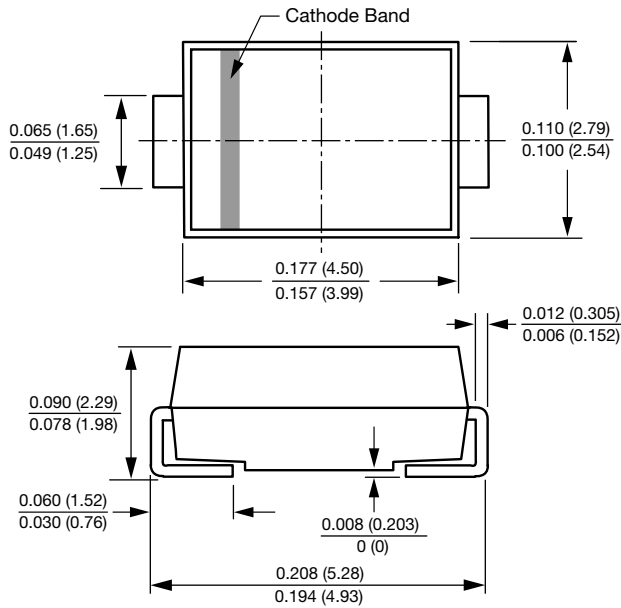

Fig. 8 - Thermal Response



PACKAGE OUTLINE DIMENSIONS in inches (millimeters)

DO-214AC (SMA)



Mounting Pad Layout

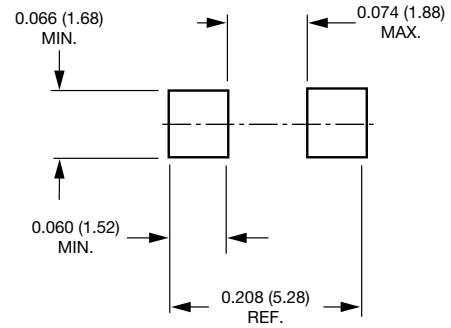



Disclaimer

ALL PRODUCT, PRODUCT SPECIFICATIONS AND DATA ARE SUBJECT TO CHANGE WITHOUT NOTICE TO IMPROVE RELIABILITY, FUNCTION OR DESIGN OR OTHERWISE.

Vishay Intertechnology, Inc., its affiliates, agents, and employees, and all persons acting on its or their behalf (collectively, "Vishay"), disclaim any and all liability for any errors, inaccuracies or incompleteness contained in any datasheet or in any other disclosure relating to any product.

Vishay makes no warranty, representation or guarantee regarding the suitability of the products for any particular purpose or the continuing production of any product. To the maximum extent permitted by applicable law, Vishay disclaims (i) any and all liability arising out of the application or use of any product, (ii) any and all liability, including without limitation special, consequential or incidental damages, and (iii) any and all implied warranties, including warranties of fitness for particular purpose, non-infringement and merchantability.

Statements regarding the suitability of products for certain types of applications are based on Vishay's knowledge of typical requirements that are often placed on Vishay products in generic applications. Such statements are not binding statements about the suitability of products for a particular application. It is the customer's responsibility to validate that a particular product with the properties described in the product specification is suitable for use in a particular application. Parameters provided in datasheets and/or specifications may vary in different applications and performance may vary over time. All operating parameters, including typical parameters, must be validated for each customer application by the customer's technical experts. Product specifications do not expand or otherwise modify Vishay's terms and conditions of purchase, including but not limited to the warranty expressed therein.

Except as expressly indicated in writing, Vishay products are not designed for use in medical, life-saving, or life-sustaining applications or for any other application in which the failure of the Vishay product could result in personal injury or death. Customers using or selling Vishay products not expressly indicated for use in such applications do so at their own risk. Please contact authorized Vishay personnel to obtain written terms and conditions regarding products designed for such applications.

No license, express or implied, by estoppel or otherwise, to any intellectual property rights is granted by this document or by any conduct of Vishay. Product names and markings noted herein may be trademarks of their respective owners.

Material Category Policy

Vishay Intertechnology, Inc. hereby certifies that all its products that are identified as RoHS-Compliant fulfill the definitions and restrictions defined under Directive 2011/65/EU of The European Parliament and of the Council of June 8, 2011 on the restriction of the use of certain hazardous substances in electrical and electronic equipment (EEE) - recast, unless otherwise specified as non-compliant.

Please note that some Vishay documentation may still make reference to RoHS Directive 2002/95/EC. We confirm that all the products identified as being compliant to Directive 2002/95/EC conform to Directive 2011/65/EU.

Vishay Intertechnology, Inc. hereby certifies that all its products that are identified as Halogen-Free follow Halogen-Free requirements as per JEDEC JS709A standards. Please note that some Vishay documentation may still make reference to the IEC 61249-2-21 definition. We confirm that all the products identified as being compliant to IEC 61249-2-21 conform to JEDEC JS709A standards.