

MULTI-LINE LOW CAPACITANCE TVS ARRAY



DESCRIPTION

The SMP6LCxx-2P Series are high powered multi-line low capacitance transient voltage suppressor arrays that provides board level protection for standard TTL and MOS bus line applications against the damaging effects of ESD, tertiary lightning and switching transients.

This series has a peak pulse power rating of 400 Watts for an 10/1000 μ s waveshape. This device series meets the IEC 61000-4-2, IEC 61000-4-4 and IEC 61000-4-5 requirements.

FEATURES

- Compatible with IEC 61000-4-2 (ESD): Air - 15kV, Contact - 8kV
- Compatible with IEC 61000-4-4 (EFT): 40A - 5/50ns
- Compatible with IEC 61000-4-5 (Surge): 100A (*Applies to 5V*)
- 100A (2/10 μ s) per Bellcore GR-1089 (Intra Building)
- 400 Watts Peak Pulse Power per Line ($t_p = 10/1000\mu$ s)
- 3,900 Watts Peak Pulse Power per Line ($t_p = 8/20\mu$ s)
- ITKU.20 I_{pp} @ 40A (5/310 μ s) (*Applies to 5V and 6.5V*)
- Bidirectional Configuration
- High Surge Capability
- Available in Multiple Voltages
- Protects 2 Bidirectional Lines
- Low Capacitance < 30pF per Line Pair
- RoHS Compliant
- REACH Compliant

APPLICATIONS

- T1/E1
- Customer Premise Equipment (CPE)
- Telecommunication Equipment
- Wireless Communication Equipment

MECHANICAL CHARACTERISTICS

- Molded JEDEC SO-16 Package
- Approximate Weight: 0.15 grams
- Lead-Free Pure-Tin Plating (Annealed)
- Solder Reflow Temperature:
Pure-Tin - Sn, 100: 260-270°C
- 16mm Tape and Reel Per EIA Standard 481
- Flammability Rating UL 94V-0

PIN CONFIGURATION

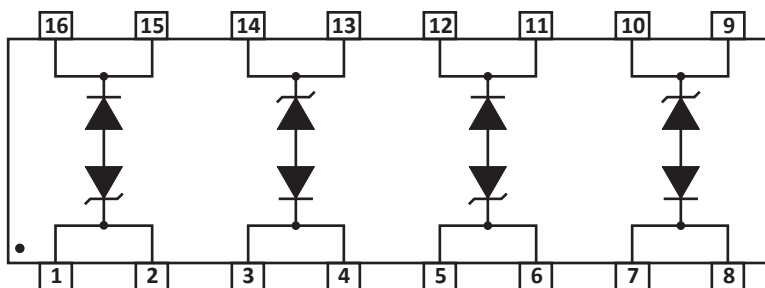

TYPICAL DEVICE CHARACTERISTICS

MAXIMUM RATINGS @ 25°C Unless Otherwise Specified

PARAMETER	SYMBOL	VALUE	UNITS
Operating Temperature	T_L	-55 to 150	°C
Storage Temperature	T_{STG}	-55 to 150	°C
Peak Pulse Power (tp = 8/20μs) - See Figure 2	P_{PP}	3,900	Watts
Peak Pulse Power (tp = 10/1000μs) - See Figure 2	P_{PP}	400	Watts

ELECTRICAL CHARACTERISTICS PER LINE @ 25°C Unless Otherwise Specified

PART NUMBER (Note 1)	RATED STAND-OFF VOLTAGE	MINIMUM BREAKDOWN VOLTAGE	MAXIMUM CLAMPING VOLTAGE (Fig. 3)	MAXIMUM LEAKAGE CURRENT	TYPICAL CAPACITANCE
	V_{WM} VOLTS	@1mA $V_{(BR)}$ VOLTS	@ 8/20μS $V_C @ I_{PP}$	@ V_{WM} I_D μA	@0V, 1MHz C pF
SMP6LC05-2P	5.0	6.0	26.0V @ 150.0A	300	15
SMP6LC6.5-2P	6.5	7.2	28.0V @ 150.0A	300	15
SMP6LC08-2P	8.0	8.6	30.0V @ 145.0A	25	15
SMP6LC12-2P	12.0	13.3	35.0V @ 140.0A	2	15
SMP6LC15-2P	15.0	16.7	50.0V @ 110.0A	2	15
SMP6LC24-2P	24.0	26.7	57.0V @ 80.0A	2	15

NOTES

1. Do not surge from pins 15/16 to 1/2, 3/4 to 13/14, 11/12 to 5/6 and 7/8 to 9/10. PIV typically greater than 100 Volts for each rectifier diode.

FIGURE 1
MAXIMUM IPP VS PULSE DURATION BY VOLTAGE

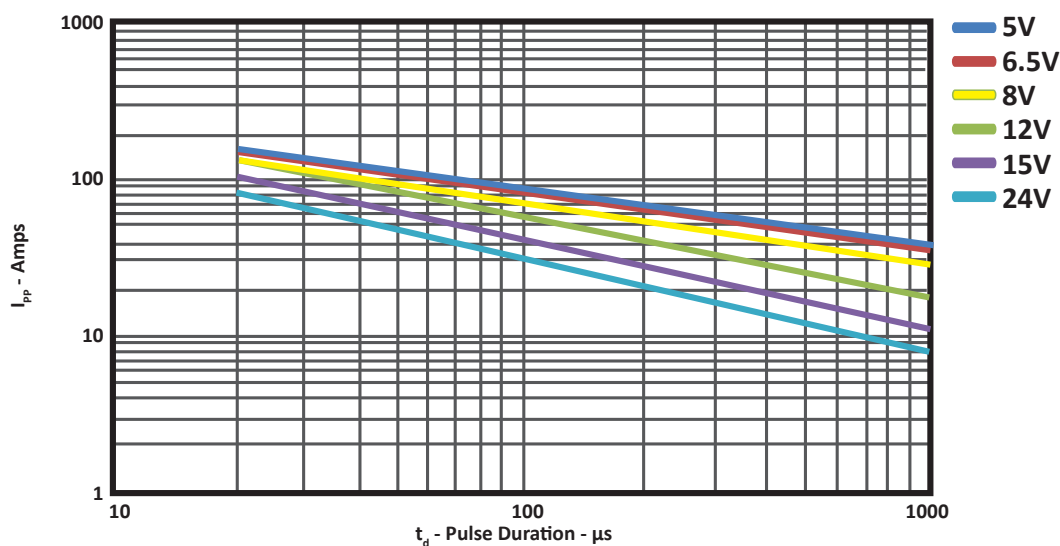

TYPICAL DEVICE CHARACTERISTICS

FIGURE 2
PEAK PULSE POWER VS PULSE TIME

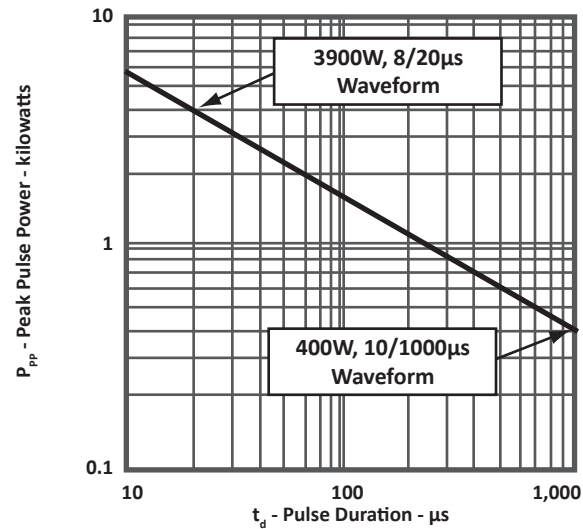

FIGURE 3
PULSE WAVE FORM

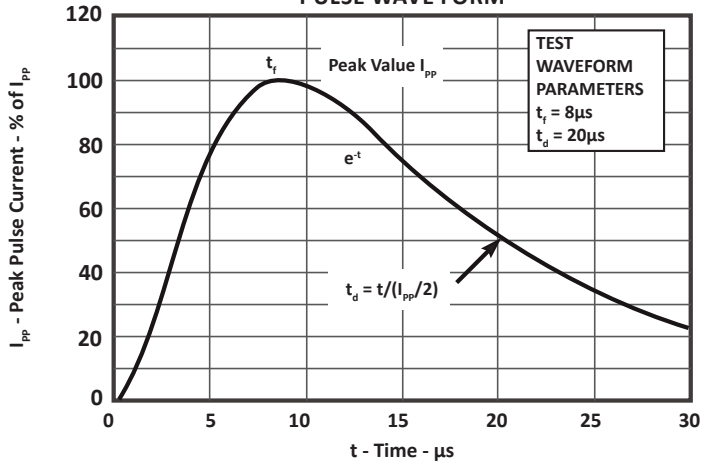
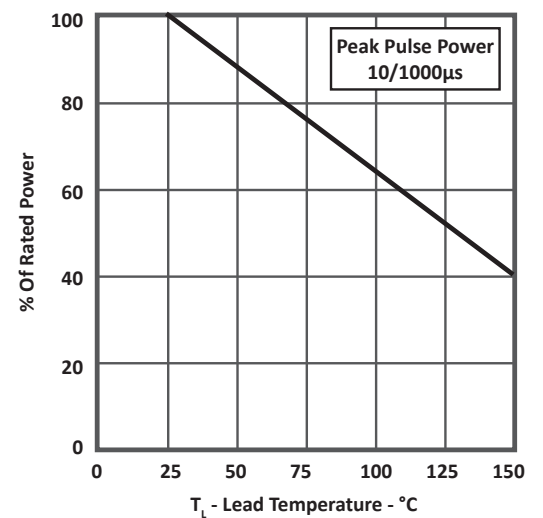
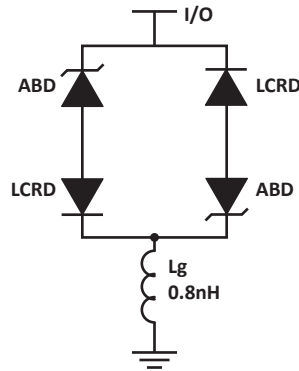

FIGURE 4
POWER DERATING CURVE



SPICE MODEL

FIGURE 1
SPICE MODEL



ABD - Avalanche Breakdown Diode (TVS)
 LCRD: Low Capacitance Rectifier Diode
 Lg - Lead Inductance

TABLE 1 - SPICE PARAMETERS

PARAMETER	UNIT	ABD(TVS)	LCRD
BV	V	See Table 2	200
IBV	μA	1	0.01
C_{jo}	pF	See Table 2	5
I_s	A	See Table 2	1E-13
Vj	V	0.6	0.6
M	-	0.33	0.33
N	-	1	1
R_s	Ohms	See Table 2	0.31
TT	s	1E-8	1E-9
EG	eV	1.11	1.11

TABLE 2 - ABD SPECIFIC SPICE PARAMETERS

PART NUMBER	B_v (VOLTS)	C_{jo} (pF)	I_s (AMPS)	R_s (OHMS)
SMP6LC05-2P	6.0	3000	1E-11	0.075
SMP6LC6.5-2P	7.2	2600	1E-11	0.075
SMP6LC12-2P	13.3	1150	1E-13	0.080

SO-16 PACKAGE INFORMATION

OUTLINE DIMENSIONS

DIM	MILLIMETERS		INCHES	
	MIN	MAX	MIN	MAX
A	9.80	10.00	0.386	0.393
B	3.80	4.00	0.150	0.157
C	1.35	1.75	0.054	0.068
D	0.35	0.49	0.014	0.019
F	0.40	1.25	0.016	0.049
G	1.27 BSC		0.05 BSC	
J	0.18	0.25	0.007	0.009
K	0.10	0.25	0.004	0.008
P	5.80	6.20	0.229	0.244
R	0.25	0.50	0.010	0.019

NOTES

- T = Seating plane and datum surface.
- Dimensions "A" and "B" are datum.
- Dimensions "A" and "B" do not include mold protrusion.
- Maximum mold protrusion is 0.015" (0.380mm) per side.
- Dimensioning and tolerances per ANSI Y14.5M, 1982.
- Dimensions are exclusive of mold flash and metal burrs.

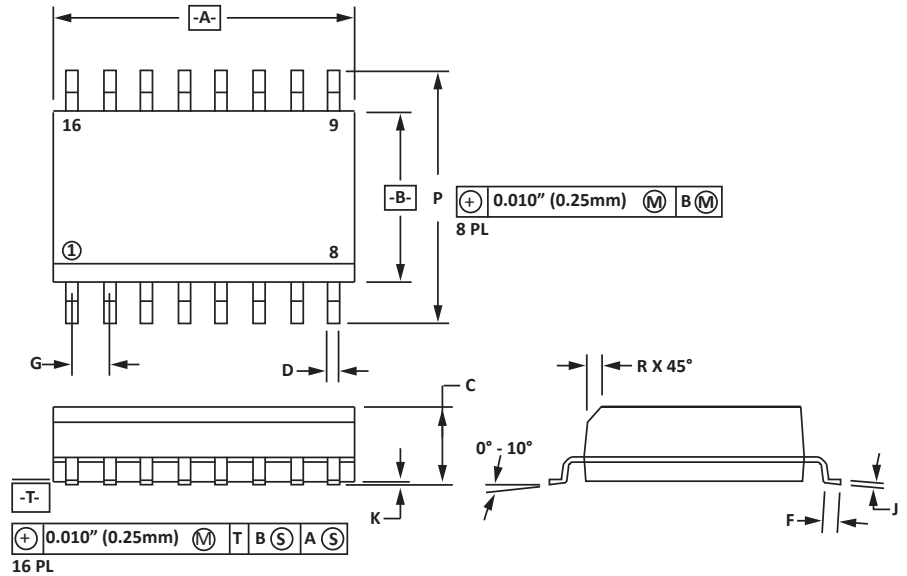

PAD LAYOUT DIMENSIONS

DIM	MILLIMETERS		INCHES	
	MIN	MAX	MIN	MAX
A	1.14	1.40	0.045	0.055
B	0.64	0.89	0.025	0.035
C	6.22	-	0.245	-
D	3.94	4.17	0.155	0.165
E	1.02	1.27	0.040	0.050

NOTES

- Controlling dimension: inches.

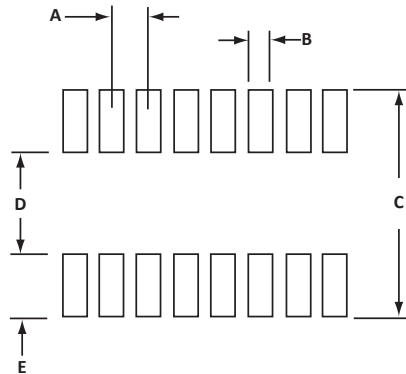

TAPE AND REEL

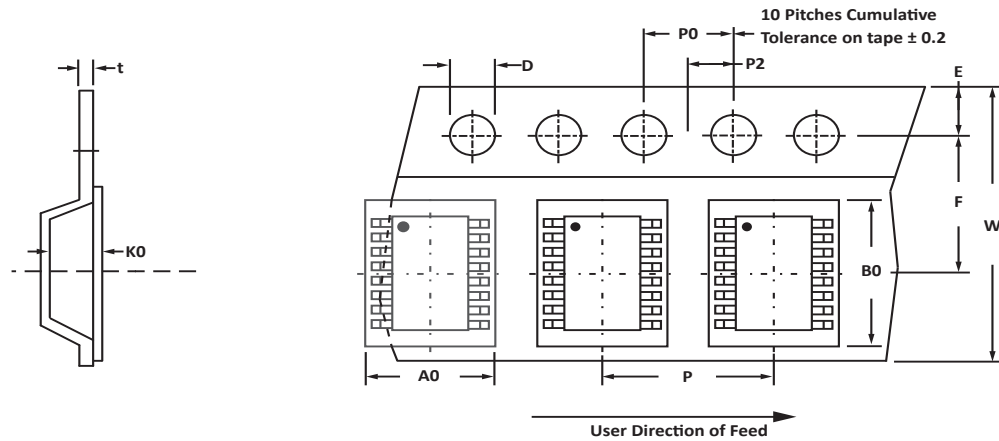

SPECIFICATIONS

REEL DIA.	TAPE WIDTH	A0	B0	K0	D	E	F	W	P0	P2	P	tmax
178mm (7")	16mm	6.50 ± 0.10	10.30 ± 0.10	2.10 ± 0.10	1.50 ± 0.10	1.75 ± 0.10	3.50 ± 0.05	16.00 ± 0.30	4.00 ± 0.12	2.00 ± 0.10	8.00 ± 0.10	0.25

NOTES

- Dimensions are in millimeters.
- Surface mount product is taped and reeled in accordance with EIA-481.
- Suffix - T7 = 7" Reel - 1,000 pieces per 16mm tape.
- Suffix - T13 = 13" Reel - 2,500 pieces per 16mm tape.
- Bulk product shipped in tubes of 48 pieces per tube.
- Marking on Part - part number, date code, logo and pin one defined by dot on top of package.

ORDERING INFORMATION

BASE PART NUMBER (xx = Voltage)	LEADFREE SUFFIX	TAPE SUFFIX	QTY/REEL	REEL SIZE	TUBE QTY
SMP6LCxx-2P	-LF	-T7	1,000	7"	48
SMP6LCxx-2P	-LF	-T13	2,500	13"	48

This device is only available in a Lead-Free configuration.

COMPANY INFORMATION

COMPANY PROFILE

In business more than 25 years, ProTek Devices™ is a privately held semiconductor company. The company offers a product line of overvoltage protection and overcurrent protection components. These include transient voltage suppressor array (TVS arrays) avalanche breakdown diode, steering diode TVS array and electronics SMD chip fuses. These components deliver circuit protection in electronic systems from numerous overvoltage and overcurrent events. They include lightning; electrostatic discharge (ESD); nuclear electromagnetic pulses (NEMP); inductive switching; and electromagnetic interference (EMI) / radio frequency interference (RFI). ProTek Devices also offers LED wafer die for ESD protection and related high frequency products. ProTek Devices is ISO 9001:2015 certified.

CONTACT US

Corporate Headquarters

2929 South Fair Lane
Tempe, Arizona 85282
USA

By Telephone

General: 602-431-8101
Sales: & Marketing: 602-414-5109
Customer Service: 602-414-5114
Product Technical Support: 602-414-5107

By Fax

General: 602-431-2288

By E-mail:

Asia Sales: asiasales@protekdevices.com
Europe Sales: europesales@protekdevices.com
U.S. Sales: ussales@protekdevices.com
Distributor Sales: distysales@protekdevices.com
Customer Service: service@protekdevices.com
Technical Support: support@protekdevices.com

ProTek Devices (Asia Pacific) Pte. Ltd.

8 Ubi Road 2, #06-19
Zervex
Singapore - 408538
Tel: +65-67488312
Fax: +65-67488313

Web

www.protekdevices.com

COPYRIGHT © ProTek Devices 2000 - This literature is subject to all applicable copyright laws and is not for resale in any manner.

SPECIFICATIONS: ProTek reserves the right to change the electrical and or mechanical characteristics described herein without notice.

DESIGN CHANGES: ProTek reserves the right to discontinue product lines without notice and that the final judgement concerning selection and specifications is the buyer's and that in furnishing engineering and technical assistance. ProTek assumes no responsibility with respect to the selection or specifications of such products. ProTek makes no warranty, representation or guarantee regarding the suitability of its products for any particular purpose, nor does ProTek assume any liability arising out of the application or use of any product or circuit and specifically disclaims any and all liability without limitation special, consequential or incidental damages.

LIFE SUPPORT POLICY: ProTek Devices products are not authorized for use in life support systems without written consent from the factory.