

HLMP-D101/D105, HLMP-K101/K105

T-1^{3/4} (5 mm), T-1 (3 mm), High Intensity, Double Heterojunction AlGaAs Red LED Lamps

Description

These solid-state LED lamps use newly developed double heterojunction (DH) AlGaAs/GaAs material technology. This LED material has outstanding light output efficiency over a wide range of drive currents. The color is deep red at the dominant wavelength of 637 nm. These lamps may be DC or pulse driven to achieve desired light output.

Features

- Exceptional brightness
- Wide viewing angle
- Outstanding material efficiency
- Low forward voltage
- CMOS/MOS compatible
- TTL compatible
- Deep red color

Applications

- Bright ambient lighting conditions
- Moving message panels
- Portable equipment
- General use

Package Dimensions

Package Outline A

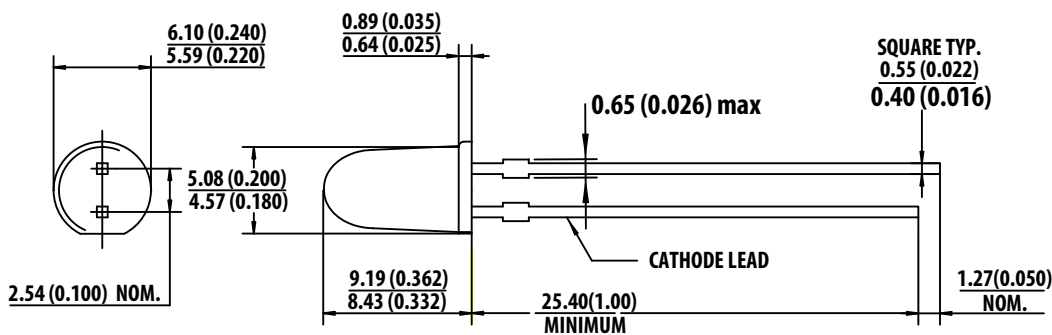

Package Outline B

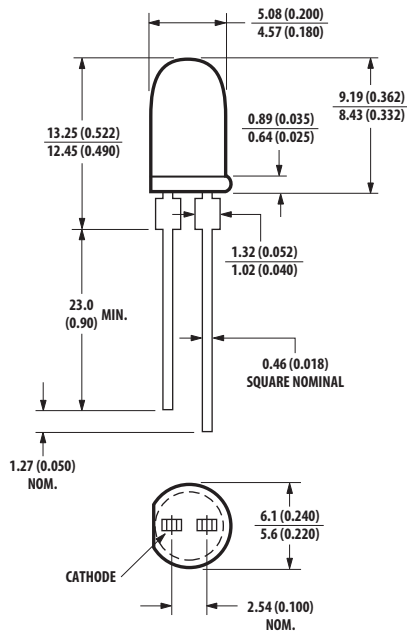

Package Outline C

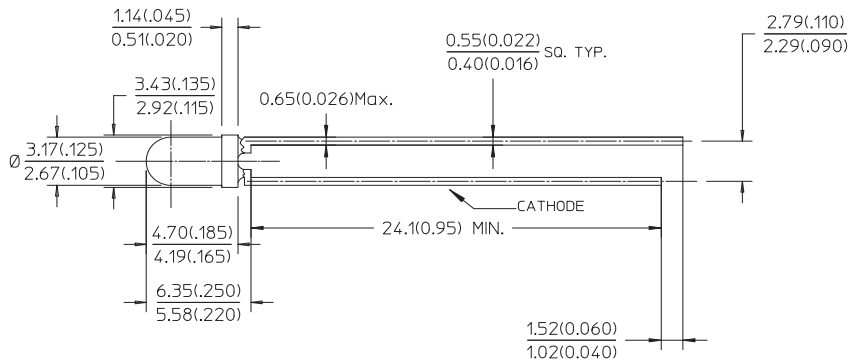

NOTE:

1. All dimensions are in mm (in.).
2. An epoxy meniscus may extend about 1 mm (0.040 in.) down the leads.
3. For PCB hole recommendations, see [Precautions](#).

Selection Guide

Package Description	Device HLMP-	Luminous Intensity I_v (mcd) at 20 mA			$2\theta_{1/2}^a$ Degree	Package Outline
		Min.	Typ.	Max.		
T-1¼ Red Tinted Diffused	D101	35.2	70.0	—	65	A
	D101-J00xx	35.2	70.0	—	65	A
	D101-JK0xx	35.2	70.0	112.8	65	A
T-1¼ Red Untinted Non-diffused	D105	138.0	240.0	—	24	B
	D105-M00xx	138.0	240.0	—	24	B
T-1 Red Tinted Diffused	K101	22.0	45.0	—	60	C
	K101-I00xx	22.0	45.0	—	60	C
T-1 Red Untinted Non-diffused	K105	35.2	65.0	—	45	C
	K105-J00xx	35.2	65.0	—	45	C

a. $\theta_{1/2}$ is the off axis angle from lamp centerline where the luminous intensity is $\frac{1}{2}$ the on-axis value.

Absolute Maximum Ratings at $T_A = 25^\circ\text{C}$

Parameter	Value
Peak Forward Current ^{a, b}	300 mA
Average Forward Current ^b	20 mA
DC Current ^c	30 mA
Power Dissipation	87 mW
Reverse Voltage ($I_R = 100 \mu\text{A}$)	5V
Transient Forward Current (10- μs Pulse) ^d	500 mA
LED Junction Temperature	110°C
Operating Temperature Range	-20°C to +100°C
Storage Temperature Range	-40°C to +100°C

a. Maximum I_{PEAK} at $f = 1 \text{ kHz}$, $DF = 6.7\%$.

b. See [Figure 6](#) to establish pulsed operating conditions.

c. Derate linearly as shown in [Figure 5](#).

d. The transient peak current is the maximum non-recurring peak current the device can withstand without damaging the LED die and wire bonds. It is not recommended that the device be operated at peak currents beyond the Absolute Maximum Peak Forward Current.

Electrical/Optical Characteristics at $T_A = 25^\circ\text{C}$

Parameter	Symbol	Min.	Typ.	Max.	Unit	Test Condition
Forward Voltage	V_F	—	1.8	2.2	V	$I_F = 20\text{ mA}$
Reverse Breakdown Voltage	V_R	5.0	15.0	—	V	$I_R = 100\text{ }\mu\text{A}$
Peak Wavelength	λ_p	—	645	—	nm	Measurement at Peak
Dominant Wavelength	λ_d	—	637	—	nm	Note ^a
Spectral Line Halfwidth	$\Delta\lambda_{1/2}$	—	20	—	nm	
Speed of Response	τ_S	—	30	—	ns	Exponential Time Constant, e^{-t}/T_S
Capacitance	C	—	30	—	pF	$V_F = 0$, $f = 1\text{ MHz}$
Thermal Resistance	$R\theta_{J-PIN}$	—	260 ^b 210 ^c 290 ^d	—	$^\circ\text{C/W}$	Junction to Cathode Lead
Luminous Efficacy	η_V	—	80	—	lm/W	Note ^e

a. The dominant wavelength, λ_d , is derived from the CIE chromaticity diagram and represents the color of the device.

b. HLMP-D101.

c. HLMP-D105.

d. HLMP-K101/-K105.

e. The radiant intensity, I_e , in watts per steradian, may be found from the equation $I_e = I_V/\eta_V$, where I_V is the luminous intensity in candelas and η_V is luminous efficacy in lumens/watt.

Part Numbering System

H L M P -

X ₁	X ₂	X ₃	X ₄
----------------	----------------	----------------	----------------

 -

X ₅	X ₆	X ₇	X ₈	X ₉
----------------	----------------	----------------	----------------	----------------

Code	Description	Option	
X ₁	Package type	D	T-1¼ (5 mm)
		K	T-1 (3 mm)
X ₂	Color options	1	AlGaAs Red
X ₃ X ₄	Lens type	01	Tinted, diffused
		05	Untinted, non-diffused
X ₅	Minimum intensity bin	See Intensity Bin Limits	
X ₆	Maximum intensity bin	0	Open binning (no maximum limit)
X ₇	Color bin selection	0	Full range
X ₈ X ₉	Packaging option	00	Bulk packaging
		02	Tape and reel

Intensity Bin Limits

Color	Bin	Intensity Range (mcd)	
		Min.	Max.
Red	I	24.8	39.6
	J	39.6	63.4
	K	63.4	101.5
	L	101.5	162.4
	M	162.4	234.6
	N	234.6	340.0
	O	340.0	540.0
	P	540.0	850.0
	Q	850.0	1200.0
	R	1200.0	1700.0
	S	1700.0	2400.0
	T	2400.0	3400.0
	U	3400.0	4900.0
	V	4900.0	7100.0
	W	7100.0	10200.0
	X	10200.0	14800.0
Y	14800.0	21400.0	
Z	21400.0	30900.0	

Maximum tolerance for each bin limit is $\pm 18\%$.

Mechanical Option Matrix

Mechanical Option Code	Definition
00	Bulk Packaging, minimum increment 500 pieces/bag
02	Tape and Reel, straight leads, minimum increment 1300 pieces (T-1¼)/1800 pieces (T-1)

NOTE: All categories are established for classification of products. Products may not be available in all categories. Please contact your local Broadcom representative for further clarification/information.

Figure 1: Relative Intensity vs. Wavelength

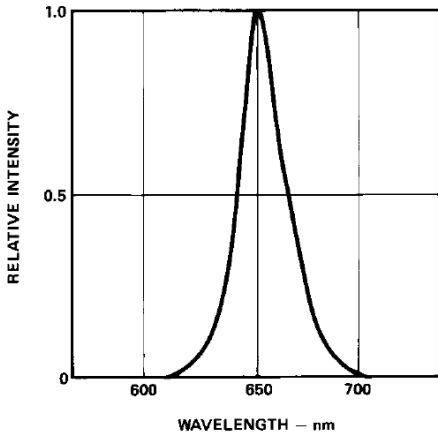

Figure 2: Forward Current vs. Forward Voltage

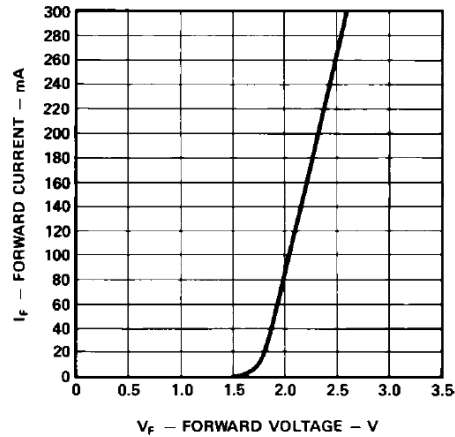

Figure 3: Relative Luminous Intensity vs. DC Forward Current

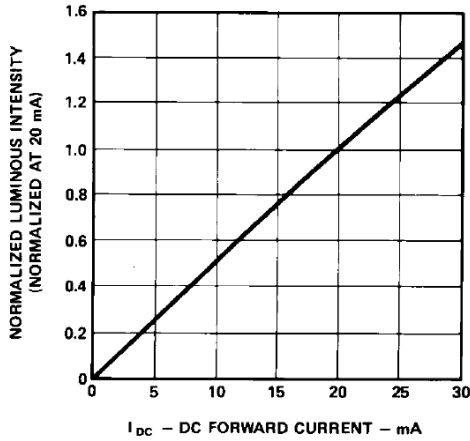

Figure 4: Relative Efficiency vs. Peak Forward Current

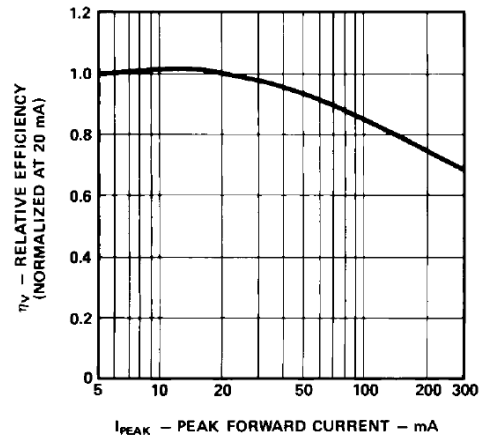

Figure 5: Maximum Forward DC Current vs. Ambient Temperature. Derating based on T_J MAX. = 110°C.

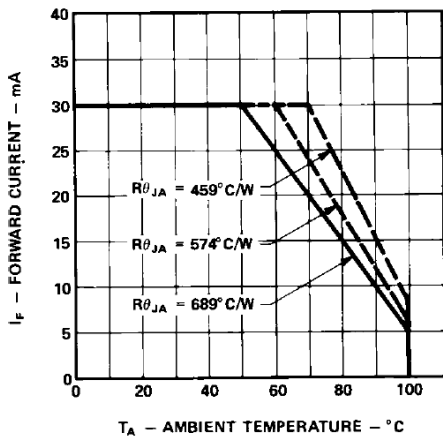

Figure 6: Maximum Tolerable Peak Current vs. Peak Duration. I_{PEAK} MAX. determined from temperature derated I_{DC} MAX.

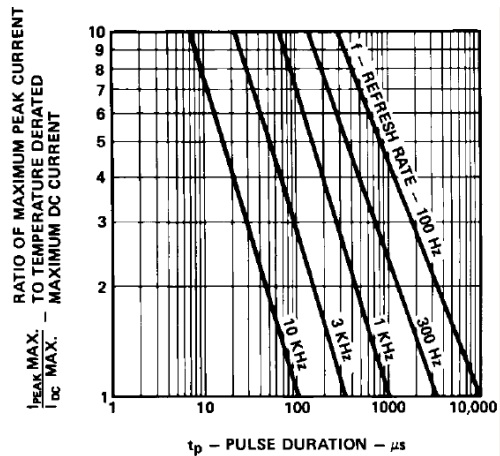

Figure 7: Relative Luminous Intensity vs. Angular Displacement, HLMP-D101

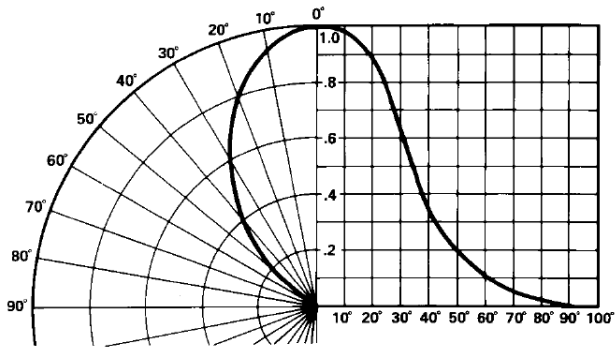

Figure 8: Relative Luminous Intensity vs. Angular Displacement, HLMP-K101

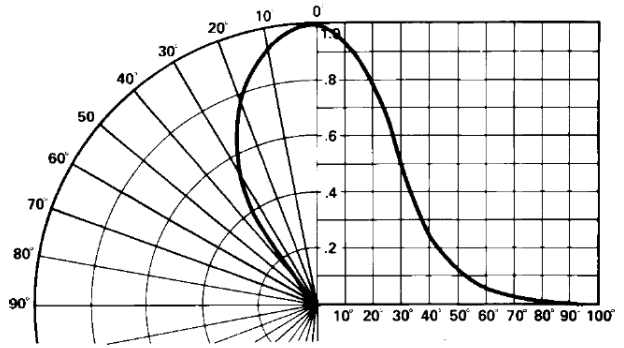

Figure 9: Relative Luminous Intensity vs. Angular Displacement, HLMP-D105

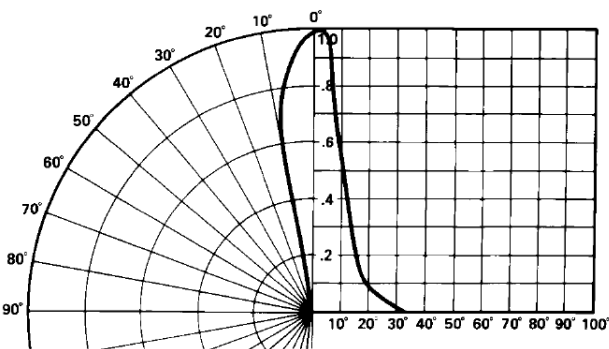
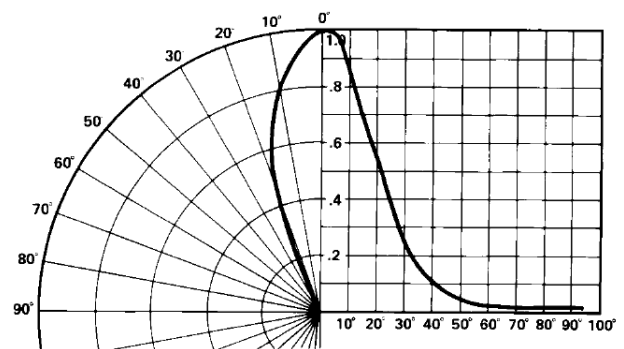

Figure 10: Relative Luminous Intensity vs. Angular Displacement, HLMP-K105



Precautions

Lead Forming

- The leads of an LED lamp may be preformed or cut to length prior to insertion and soldering on PC board.
- For better control, use the proper tool to precisely form and cut the leads to applicable length rather than doing it manually.
- If manual lead cutting is necessary, cut the leads after the soldering process. The solder connection forms a mechanical ground that prevents mechanical stress due to lead cutting from traveling into LED package. Use this method for the hand soldering operation, because the excess lead length also acts as small heat sink.

Soldering and Handling

- Take care during the PCB assembly and soldering process to prevent damage to the LED component.
- LED component may be effectively hand soldered to PCB. However, do this under unavoidable circumstances, such as rework. The closest manual soldering distance of the soldering heat source (soldering iron’s tip) to the body is 1.59 mm. Soldering the LED using soldering iron tip closer than 1.59 mm might damage the LED.

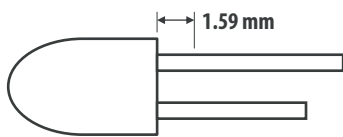

- Apply ESD precautions on the soldering station and personnel to prevent ESD damage to the LED component that is ESD sensitive. Refer to Broadcom application note AN 1142 for details. The soldering iron used must have a grounded tip to ensure electrostatic charge is properly grounded.
- Recommended soldering condition.

Wave Soldering ^{a, b}	Manual Solder Dipping	
Pre-heat Temperature	105°C max.	—
Pre-heat Time	60s max.	—
Peak Temperature	250°C max.	260°C max.
Dwell Time	3s max.	5s max.

- The preceding conditions refer to measurement with a thermocouple mounted at the bottom of the PCB.
- Use only bottom pre-heaters to reduce thermal stress experienced by LED.

- Set and maintain wave soldering parameters according to the recommended temperature and dwell time. Perform daily checks on the soldering profile to ensure that it always conforms to the recommended soldering conditions.

NOTE:

- PCBs with different size and design (component density) will have a different heat mass (heat capacity). This might cause a change in temperature experienced by the board if the same wave soldering setting is used. Therefore, re-calibrate the soldering profile again before loading a new type of PCB.
 - Take extra precautions during wave soldering to ensure that the maximum wave temperature does not exceed 250°C and the solder contact time does not exceed 3s. Over-stressing the LED during the soldering process might cause premature failure to the LED due to delamination.
- Loosely fit any alignment fixture that is being applied during wave soldering and do not apply weight or force on the LED. Use non-metal material because it will absorb less heat during the wave soldering process.
 - At elevated temperature, LED is more susceptible to mechanical stress. Therefore, allow the PCB to cool down to room temperature prior to handling, which includes removal of alignment fixture or pallet.
 - If PCB board contains both through-hole (TH) LED and other surface-mount components, solder surface-mount components on the top side of the PCB. If the surface mount must be on the bottom side, solder these components using reflow soldering prior to the insertion of the TH LED.
 - The recommended PC board plated through holes (PTH) size for LED component leads follows.

	LED Component Lead Size	Diagonal	Plated Through-Hole Diameter
Lead size (typ.)	0.45 × 0.45 mm (0.018 × 0.018 in.)	0.636 mm (0.025 in.)	0.98 to 1.08 mm (0.039 to 0.043 in.)
Dambar shear-off area (max.)	0.65 mm (0.026 in.)	0.919 mm (0.036 in.)	
Lead size (typ.)	0.50 × 0.50 mm (0.020 × 0.020 in.)	0.707 mm (0.028 in.)	1.05 to 1.15 mm (0.041 to 0.045 in.)
Dambar shear-off area (max.)	0.70 mm (0.028 in.)	0.99 mm (0.039 in.)	

NOTE: Refer to application note AN1027 for more information on soldering LED components.

- Over-sizing the PTH can lead to twisted LED after clinching. On the other hand under sizing the PTH can cause difficulty inserting the TH LED.

Refer to application note AN5334 for more information about soldering and handling of TH LED lamps.

Figure 11: Example of Wave Soldering Temperature Profile for TH LED

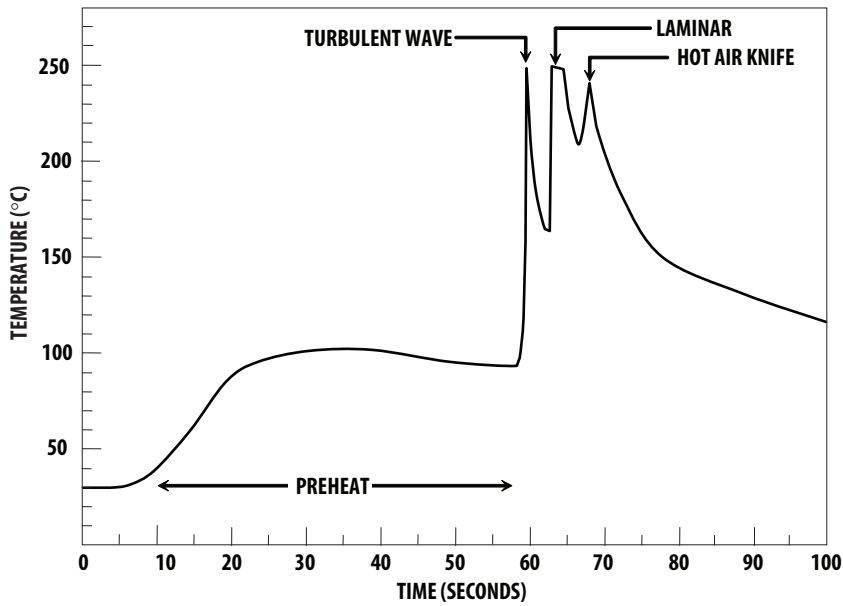

Recommended solder:
 Sn63 (Leaded solder alloy)
 SAC305 (Lead-free solder alloy)

Flux: Rosin flux

Solder bath temperature:
 245°C ± 5 °C (maximum peak temperature = 250°C)

Dwell time: 1.5s – 3.0s (maximum = 3 seconds)

Note: Allow for board to be sufficiently cooled to room temperature before you exert mechanical force.

Broadcom, the pulse logo, Connecting everything, Avago Technologies, Avago, and the A logo are among the trademarks of Broadcom and/or its affiliates in the United States, certain other countries, and/or the EU.

Copyright © 2015–2018 Broadcom. All Rights Reserved.

The term “Broadcom” refers to Broadcom Inc. and/or its subsidiaries. For more information, please visit www.broadcom.com.

Broadcom reserves the right to make changes without further notice to any products or data herein to improve reliability, function, or design. Information furnished by Broadcom is believed to be accurate and reliable. However, Broadcom does not assume any liability arising out of the application or use of this information, nor the application or use of any product or circuit described herein, neither does it convey any license under its patent rights nor the rights of others.

Mouser Electronics

Authorized Distributor

Click to View Pricing, Inventory, Delivery & Lifecycle Information:

Broadcom Limited:

[HLMP-K101](#) [HLMP-K101-I0002](#) [HLMP-K105](#) [HLMP-K105-J0002](#) [HLMP-K150](#) [HLMP-K150-C0002](#) [HLMP-K150-C00A1](#) [HLMP-K150-CD000](#)