

## 3-phase inverter based on STSPIN32F0602

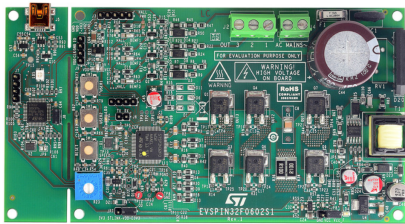

### Features

- Input voltage from 50 V to 280 V DC/AC
- STD18N65M5 MOS power stage featuring:
  - $V_{DS} @ T_{Jmax} = 710 \text{ V}$
  - $R_{DS(on)} \text{ max.} = 0.220 \Omega$
- Overcurrent threshold set to  $8.5 A_{peak}$
- Dual footprint for IGBT/MOSFET package:
  - DPAK
  - PowerFlat 8x8 HV
- Single-shunt current sensing, suitable for:
  - Sensored or sensorless 6-step algorithm
  - Single-shunt vector (FOC) algorithm
- Smart shutdown overcurrent protection
- Digital Hall sensors and encoder input
- Bus voltage sensing
- 15 V VCC and 3.3 V VDD supplies
- Embedded ST-LINK/V2-1
- Easy user interface with buttons and trimmer
- RoHS compliant

Product status link

[EVSPIN32F0602S1](#)

### Applications

- Home and Industrial refrigerators compressors
- Industrial drives, pumps, fans
- Air conditioning compressors & fans
- Corded power tools, garden tools
- Home appliances
- Industrial automation

### Description

The [EVSPIN32F0602S1](#) board is a 3-phase complete inverter based on the STSPIN32F0602 controller, which embeds a 3-phase 600 V gate driver and a Cortex<sup>®</sup>-M0 STM32 MCU. The power stage features STD18N65M5 MOS, but can be populated with any IGBT or Power MOSFET in DPAK or powerFLAT 8x8 HV package.

The board has a single-shunt sensing topology, and both the field-oriented control (FOC) and sensored or sensorless 6-step control can be implemented. This allows driving permanent magnet synchronous motors (PMSMs) and brushless DC (BLDC) motors.

The evaluation board is compatible with a wide range input voltage from 50 V to 280 V DC/AC, and includes a power supply stage with the VIPER06XS in flyback configuration to generate +15 V and +3.3 V supply voltage required by the application.

Debug and configuration of FW can be performed with standard STM32 tools through the detachable STLINK-debugger. SWD and UART TX-RX connectors are also available.

## 1 Safety and operating instructions



### 1.1 General terms

**Warning:**

During assembly, testing, and operation, the evaluation board poses several inherent hazards, including bare wires, moving or rotating parts and hot surfaces.

**Danger:**

*There is danger of serious personal injury, property damage or death due to electrical shock and burn hazards if the kit or components are improperly used or installed incorrectly.*

The kit is not electrically isolated from the high-voltage supply AC/DC input. The evaluation board is directly linked to the mains voltage. No insulation is ensured between the accessible parts and the high voltage. All measuring equipment must be isolated from the mains before powering the board. When using an oscilloscope with the demo, it must be isolated from the AC line. This prevents shock from occurring as a result of touching any single point in the circuit, but does NOT prevent shock when touching two or more points in the circuit.

All operations involving transportation, installation and use, and maintenance must be performed by skilled technical personnel able to understand and implement national accident prevention regulations. For the purposes of these basic safety instructions, "skilled technical personnel" are suitably qualified people who are familiar with the installation, use and maintenance of power electronic systems.

### 1.2 Intended use of evaluation board

The evaluation board is designed for demonstration purposes only, and must not be used for electrical installations or machinery. Technical data and information concerning the power supply conditions are detailed in the documentation and should be strictly observed.

### 1.3 Installing the evaluation board

- The installation and cooling of the evaluation board must be in accordance with the specifications and target application.
- The motor drive converters must be protected against excessive strain. In particular, components should not be bent or isolating distances altered during transportation or handling.
- No contact must be made with other electronic components and contacts.
- The board contains electrostatically-sensitive components that are prone to damage if used incorrectly. Do not mechanically damage or destroy the electrical components (potential health risks).

### 1.4 Operating the evaluation board

To operate properly the board, follow these safety rules.

1. Work Area Safety:

- The work area must be clean and tidy.
- Do not work alone when boards are energized.
- Protect against inadvertent access to the area where the board is energized using suitable barriers and signs.
- A system architecture that supplies power to the evaluation board must be equipped with additional control and protective devices in accordance with the applicable safety requirements (i.e., compliance with technical equipment and accident prevention rules).
- Use non-conductive and stable work surface.
- Use adequately insulated clamps and wires to attach measurement probes and instruments.

#### 2. Electrical Safety:

- Remove power supply from the board and electrical loads before performing any electrical measurement.
- Proceed with the arrangement of measurement setup, wiring or configuration paying attention to high voltage sections.
- Once the setup is complete, energize the board.

---

#### **Danger:**

*Do not touch the evaluation board when it is energized or immediately after it has been disconnected from the voltage supply as several parts and power terminals containing potentially energized capacitors need time to discharge.*

*Do not touch the boards after disconnection from the voltage supply as several parts like heat sinks and transformers may still be very hot.*

*The kit is not electrically isolated from the AC/DC input. The USB interface of the board does not insulate host computer from high voltage. When the board is supplied at a voltage outside the ELV range, a proper insulation method such as a USB isolator must be used to operate the board.*

---

#### 3. Personal Safety

- Always wear suitable personal protective equipment such as, for example, insulating gloves and safety glasses.
- Take adequate precautions and install the board in such a way to prevent accidental touch. Use protective shields such as, for example, insulating box with interlocks if necessary.

## 2 Schematic diagram

Figure 1. EVSPIN32F06021s schematic – Driver output stages

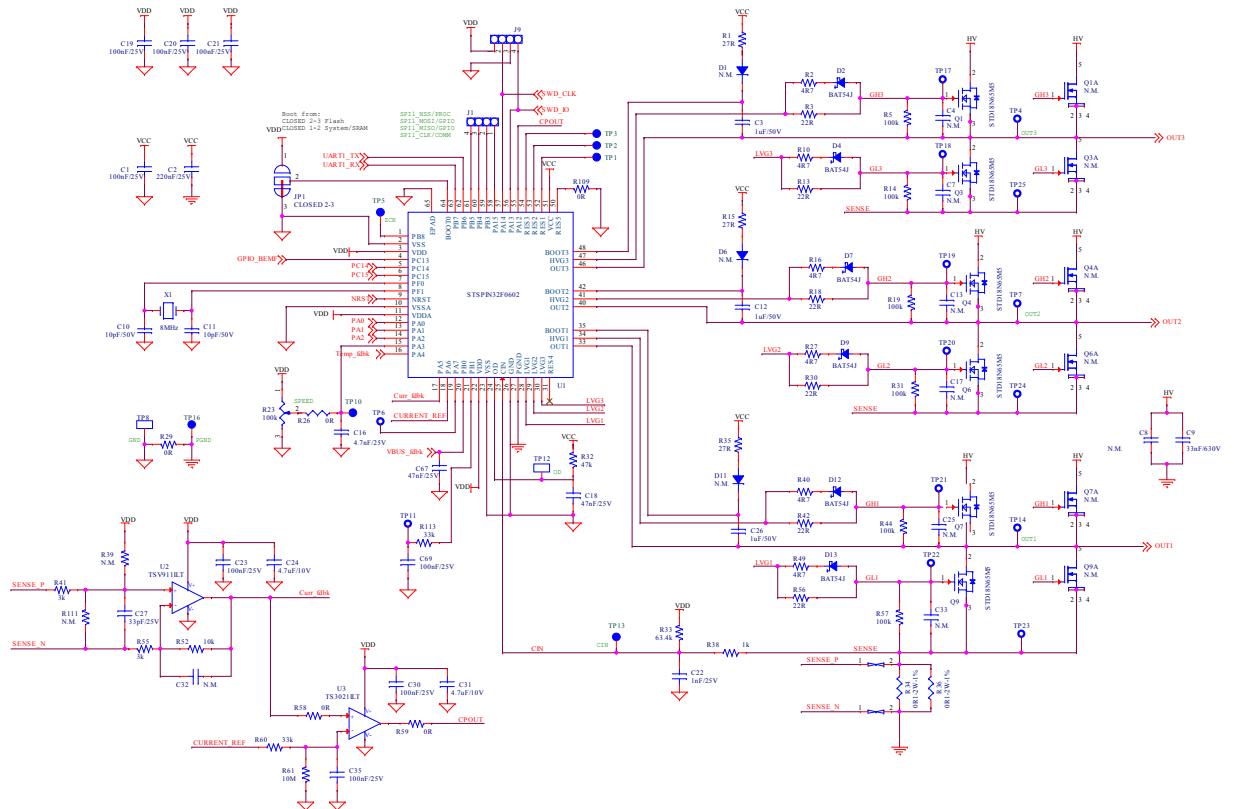
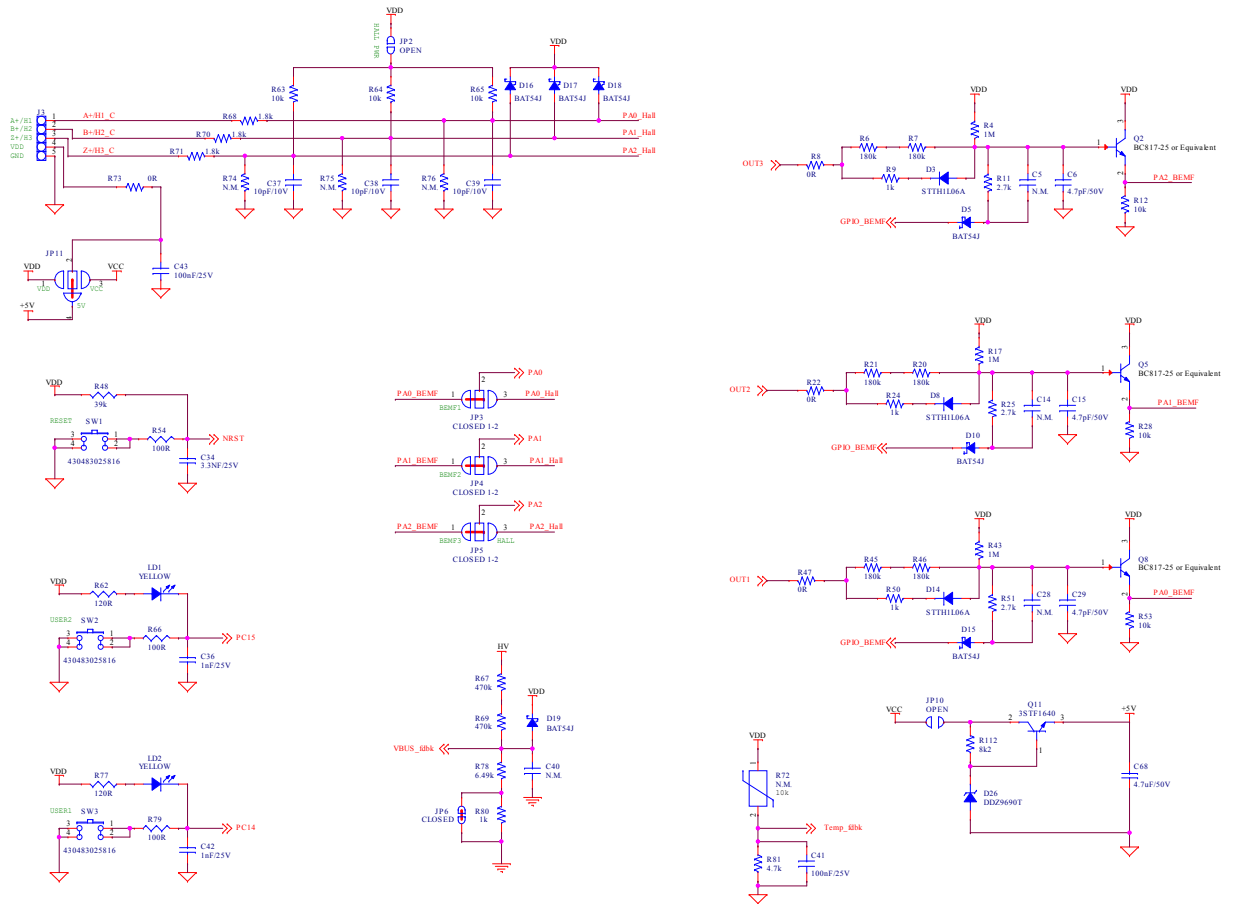

Figure 2. EVSPIN32F06021s schematic – Feedback network









### 3 Bill of material

**Table 1. Bill of Materials – Components common to all device variants**

Reference	Part Value	Description	Package	Manufacturer	Part Number
C1, C19, C20, C21, C23, C30, C35, C41, C43, C47, C53, C55, C56, C62, C63, C64, C65, C69	100nF/25V	SMT ceramic capacitor	Size 0603	Würth Elektronik	885012206071
C2	220nF/25V	SMT ceramic capacitor	Size 0603	Würth Elektronik	885012206073
C3,C12,C26	1uF/50V	SMT ceramic capacitor	Size 0805	Würth Elektronik	885012207103
C4, C5, C7, C13, C14, C17, C25, C28, C32, C33, C40	N.M.	SMT ceramic capacitor	Size 0603		
C6, C15, C29	4.7pF/50V	SMT ceramic capacitor	Size 0603	Würth Elektronik	885012006049
C8	N.M.	Film, metallized polypropylene	4x13mm, pitch 10mm	Kemet	R71MF31004030K
C9	33nF/630V	SMT ceramic capacitor	Size 1210	Würth Elektronik	885342209004
C10, C11, C59, C60	10pF/50V	SMT ceramic capacitor	Size 0603	Würth Elektronik	885012006051
C16	4.7nF/25V	SMT ceramic capacitor	Size 0603	Würth Elektronik	885012206063
C18,C67	47nF/25V	SMT ceramic capacitor	Size 0603	Würth Elektronik	885012206069
C22,C36,C42	1nF/25V	SMT ceramic capacitor	Size 0603	Würth Elektronik	885012206059
C24,C31	4.7uF/10V	SMT ceramic capacitor	Size 0805	Würth Elektronik	885012207025
C27	33pF/25V	SMT ceramic capacitor	Size 0603	Würth Elektronik	885012006035
C34	3.3nF/25V	SMT ceramic capacitor	Size 0603	Würth Elektronik	885012206062
C37,C38, C39	10pF/10V	SMT ceramic capacitor	Size 0603	Würth Elektronik	885012006002
C44A	N.M.	THT electrolytic capacitor, radial p7.5 d18h25	Radial p7.5 d18h25 mm	Rubycon	450BXW68MEFC18X25
C44	150uF/420V	THT electrolytic capacitor, radial p10 d22h27 105C	Radial p10 d22h27.5 mm	United Chemi-Con	EKMZ421VSN151MP25S
C45	22uF/25V	SMD aluminum elect. capacitor	5x5.4 mm	Würth Elektronik	865090442004
C46	470uF/10V	SMD aluminum elect. capacitor	6.3x7.7 mm	Panasonic	EEEFTA471XAP
C48	10uF/10V	SMT ceramic capacitor	Size 1206	Würth Elektronik	885012208018
C49	47uF/25V	SMD aluminum elect. capacitor	6.3x5.8 mm	Würth Elektronik	865060443004
C50	10uF/35V	SMD aluminum elect. capacitor	5x5.4 mm	Würth Elektronik	865230542002
C51	820pF/25V	SMT ceramic capacitor	Size 0603		
C52	680nF/10V	SMT ceramic capacitor	Size 0603	Würth Elektronik	885012206025
C54,C58	1uF/10V	SMT ceramic capacitor	Size 0603	Würth Elektronik	885012206026
C57	10nF/25V	SMT ceramic capacitor	Size 0603	Würth Elektronik	885012206065
C61	100nF/50V	SMT ceramic capacitor	Size 0603	Würth Elektronik	885012206095
C66	220pF/630V	SMT ceramic capacitor	Size 1206	Multicomp	MC1206N221J631CT
C68	4.7uF/50V	SMT ceramic capacitor	Size 1206	Würth Elektronik	885012208094

Reference	Part Value	Description	Package	Manufacturer	Part Number
D1, D6, D11	N.M.	Turbo 2 ultrafast high-voltage rectifier	SMA	STMicroelectronics	STTH1L06A
D2, D4, D5, D7, D9, D10, D12, D13, D15, D16, D17, D18, D19, D24	BAT54J	40V, 300mA small signal Schottky SMT Diode	SOD-323	STMicroelectronics	BAT54JFILM
D3, D8, D14, D25	STTH1L06A	Turbo 2 ultrafast high-voltage rectifier	SMA	STMicroelectronics	STTH1L06A
D20	GBU805	8A Glass passivated single-phase bridge rectifier	GBU	Taiwan Semiconductor or Diodes Incorporated	GBU805 or GBU806
D21	N.M.	Zener 3V3	SOD-123		
D22	STPS0560Z	60V, 0.5A Schottky rectifier	SOD-123	STMicroelectronics	STPS0560Z
D23	STPS1150A	150V, 1A power Schottky rectifier	SMA	STMicroelectronics	STPS1150A
D26	DDZ9690T	Surface mount Zener diode	SOD523	Diodes Incorporated	DDZ9690T-7
F1A	N.M.	Time-lag radial lead micro fuse, 250Vac	RST-Bel Fuse	Bel Fuse	0697-xx
F1	10A/277V slow	Surface mount fuse, time-lag T, 250Vac/125Vdc	UMT250-Shurter	Schurter	3403.0176.24
JP1	Closed 2-3	SMT jumper	Soldering pad		
JP2,JP10	Open	SMT jumper	Soldering pad		
JP3,JP4, JP5	Closed 1-2	SMT jumper	Soldering pad		
JP6	Closed	SMT jumper	Soldering pad		
JP7,JP8	Closed 1-2	Strip connector 3 pos, 2.54mm	1x3 pins	Würth Elektronik	61300311121
JP9	Open	SMT jumper	Soldering pad		
JP11	Closed 2-4	SMT jumper	Soldering pad		
J1,J7,J9	STRIP 1x4	Strip connector 4 pos, 2.54mm	1x4 pins	Würth Elektronik	61300411121
J2	MORSV-508-3 P_screw	Connector terminal block T.H. 3 positions 5.08mm	3 poles, Pitch 5.08	Würth Elektronik	691213510003
J3	STRIP 1x5	Strip connector 5 pos, 2.54mm	1x5 pins	Würth Elektronik	61300511121
J4	MORSV-508-2 P_screw	Connector terminal block T.H. 2 positions 5.08mm	2 poles, Pitch 5.08	Würth Elektronik	691213510002
J5	65100516121	Mini USB 2.0 type B SMD	USB mini B	Würth Elektronik	65100516121
J6	STRIP 1x2	Strip connector 2 pos, 2.54mm	1x2 pins	Würth Elektronik	61300211121
J8	Closed	Strip connector 2 pos, 2.54mm	1x2 pins	Würth Elektronik	61300211121
LD1,LD2	Yellow	Yellow LED	Size 0603	Würth Elektronik	150060YS75000
LD3	Red	Red LED	Size 0603	Würth Elektronik	150060RS75000
LD4	Green	Green Led	Size 0805	Würth Elektronik	150080GS75000
LD5	Red-green	LED indicators, PLCC-4 Red / Yellow Green	PLCC 4	Avago	HSMF-A201-A00J1
NTC1	2R2	NTC thermistor for inrush current limiting		TDK	B57236S0229M000
Q1, Q3, Q4, Q6, Q7, Q9	STD18N65M5	N-channel 650V, 0.198 Ω typ., 15A, MDmesh™ M5 Power MOSFETs	DDPAK	STMicroelectronics	STD18N65M5

Reference	Part Value	Description	Package	Manufacturer	Part Number
Q1A,Q3A, Q4A, Q6A, Q7A, Q9A	N.M.	N-channel 600V, 0.195 Ohm typ., 15A MDmesh DM2 Power MOSFET	PowerFLAT 8x8	STMicroelectronics	STL24N60DM2
Q2,Q5,Q8	BC817-25	45V NPN small signal transistor	SOT23		BC817-25
Q10	BC847B	General purpose_45V_100mA_225mW	SOT23	ON Semiconductor	BC847BL
Q11	3STF1640	Low voltage high performance NPN power transistor	SOT-89	STMicroelectronics	3STF1640
RV1	N.M.	Varistor	Pitch 2.3x7.5mm		
R1, R15, R35	27R	SMT resistor	Size 0805		
R2, R10, R16, R27, R40, R49	4R7	SMT resistor	Size 0805		
R3, R13, R18, R30, R42, R56	22R	SMT resistor	Size 0805		
R4, R17, R43	1M	SMT resistor	Size 0603		
R5, R14, R19, R31, R44, R57, R105, R106	100k	SMT resistor	Size 0603		
R6,R7,R20,R21,R 45,R46	180k	SMT resistor	Size 1206		
R8, R22, R47	0R	SMT resistor	Size 0805		
R9, R24, R50, R80	1k	SMT resistor	Size 0805		
R11,R25, R51, R96	2.7k	SMT resistor	Size 0603		
R12,R28, R52, R53, R63, R64, R65, R89, R90, R103	10k	SMT resistor	Size 0603		
R23	100k	Square trimpot trimming potentiometer	3386P	BOURNS	3386P-1-104-LF
R26,R29, R58, R59, R73, R95, R97, R99,R101	0R	SMT resistor	Size 0603		
R32	47k	SMT resistor	Size 0603		
R33	63.4k	SMT resistor	Size 0603		
R34,R36	0R1-2W-1%	SMT resistor	Size 2512		
R38	1k	SMT resistor	Size 0603		
R39,R74, R75, R76, R104, R111	N.M.	SMT resistor	Size 0603		
R41,R55	3k	SMT resistor	Size 0603		
R48	39k	SMT resistor	Size 0603		
R54,R66, R79, R91, R102, R107, R108	100R	SMT resistor	Size 0603		
R60,R113	33k	SMT resistor	Size 0603		
R61	10M	SMT resistor	Size 0603		
R62,R77	120R	SMT resistor	Size 0603		

Reference	Part Value	Description	Package	Manufacturer	Part Number
R67,R69	470k	SMT resistor	Size 1206		
R68,R70,R71	1.8k	SMT resistor	Size 0603		
R72	N.M.	NTC resistor	Hole 0.8mm		
R81,R94, R98, R100	4.7k	SMT resistor	Size 0603		
R78	6.49k	SMT resistor	Size 0805		
R82	330R	SMT resistor	Size 0603		
R83	0R	SMT resistor	Size 1206		
R84,R93	36k	SMT resistor	Size 0603		
R85	10R	SMT resistor	Size 0603		
R86,R87	22k	SMT resistor	Size 0603		
R88	1.5k	SMT resistor	Size 1206		
R92	1.5k	SMT resistor	Size 0603		
R109	0R	SMT resistor	Size 0603		
R110	220K 1/3W	SMT resistor	Size 0805	TE Connectivity	CRGH0805J220K
R112	8k2	SMT resistor	Size 0603		
SW1,SW2, SW3	430483025816	CMS tactile switches - 6x6 J-bend		Würth Elektronik	430483025816
TP1	N.M. (TPHIN1)	Point test PCB 1mm diameter	Copper pad		TPSMD-1mm
TP2	N.M. (TPHIN2)	Point test PCB 1mm diameter	Copper pad		TPSMD-1mm
TP3	N.M. (TPHIN3)	Point test PCB 1mm diameter	Copper pad		TPSMD-1mm
TP4,TP6, TP7, TP11, TP14 ,TP17, TP18, TP19, TP20, TP21, TP22, TP23, TP24, TP25	N.M.	TP for probe	Diam. 1.27, Hole 0.8mm		
TP5	N.M. (ZCR)	Point test PCB 1mm diameter	Copper pad		TPSMD-1mm
TP8,TP12	TPTH anello-1mm	THT ring test point		Keystone	5003
TP10	N.M. (SPEED)	Point Test PCB 1mm diameter	Copper pad		TPSMD-1mm
TP13,TP16	N.M. (CIN, PGND)	Point Test PCB 1mm diameter	Copper pad		TPSMD-1mm
TP15	NEEDLE-pad-1.7mm	Point test PCB 1.7mm diameter	Copper pad		NEEDLE-pad-1.7mm
T1	750318434	Switch mode transformer 2.3W 60kHz 3.15mH 7-15V		Würth Elektronik	750318434
U1	STSPIN32F0602	600V 3-phase controller with ARM Cortex MCU	TQFP64-10x10 x1.0	STMicroelectronics	STSPIN32F0602/TR
U2	TSV911ILT	Single rail-to-rail input/output 8MHz operational amplifiers	SOT23-5	STMicroelectronics	TSV911ILT
U3	TS3021ILT	Rail-to-rail 1.8V high-speed comparator	SOT23-5	STMicroelectronics	TS3021ILT
U4	LD1117S33CTR	800mA, 3.3V adjustable and fixed low drop positive Voltage Regulator	SOT-223	STMicroelectronics	LD1117S33CTR
U5	VIPER06XS	Fixed-frequency VIPer plus family	SSO10	STMicroelectronics	VIPER06XS

Reference	Part Value	Description	Package	Manufacturer	Part Number
U6	USBLC6-2SC6	Very low capacitance ESD protection	SOT23-6L	STMicroelectronics	USBLC6-2SC6
U7	LD3985M33R	3.3V_150mA_ultra low drop Voltage Regulator	SOT23-5L	STMicroelectronics	LD3985M33R
U8	STM32F103C BT6	64/182KB flash_USB_72MHz_3.6V	LQFP48 - 7x7 mm	STMicroelectronics	STM32F103CBT6
X1,X2	8MHz	Crystal 8.0000MHZ 8PF SMD	2.5x3.2 mm	NDK	NX3225GD-8MHZ-STD- CRA-3
		Rubber feet		Hammond	1421T6CL
J8, JP7, JP8		Female jumper isolated, pitch 2.54mm		Assmann WSW	AKSCT/Z BLACK
		P.C.B. EVSPIN32F0602S1 Rev.1.0		STMicroelectronics	

## 4 Layout and component placements

Figure 5. EVSPIN32F06021s – Board functions description

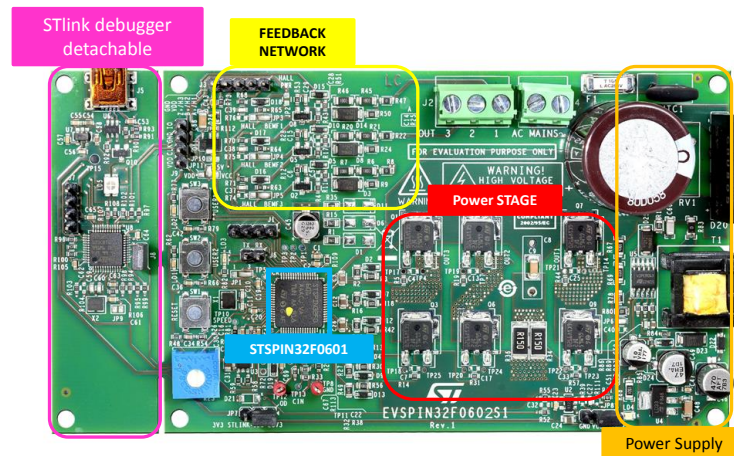

**Warning:**

The kit is not electrically isolated from the AC/DC input. The USB interface of the board does not insulate host computer from high voltage. When the board is supplied at a voltage outside the ELV range, a proper insulation method such as a USB isolator must be used to operate the board.

**Figure 6. EVSPIN32F06021s – Layout (component placement top view)**

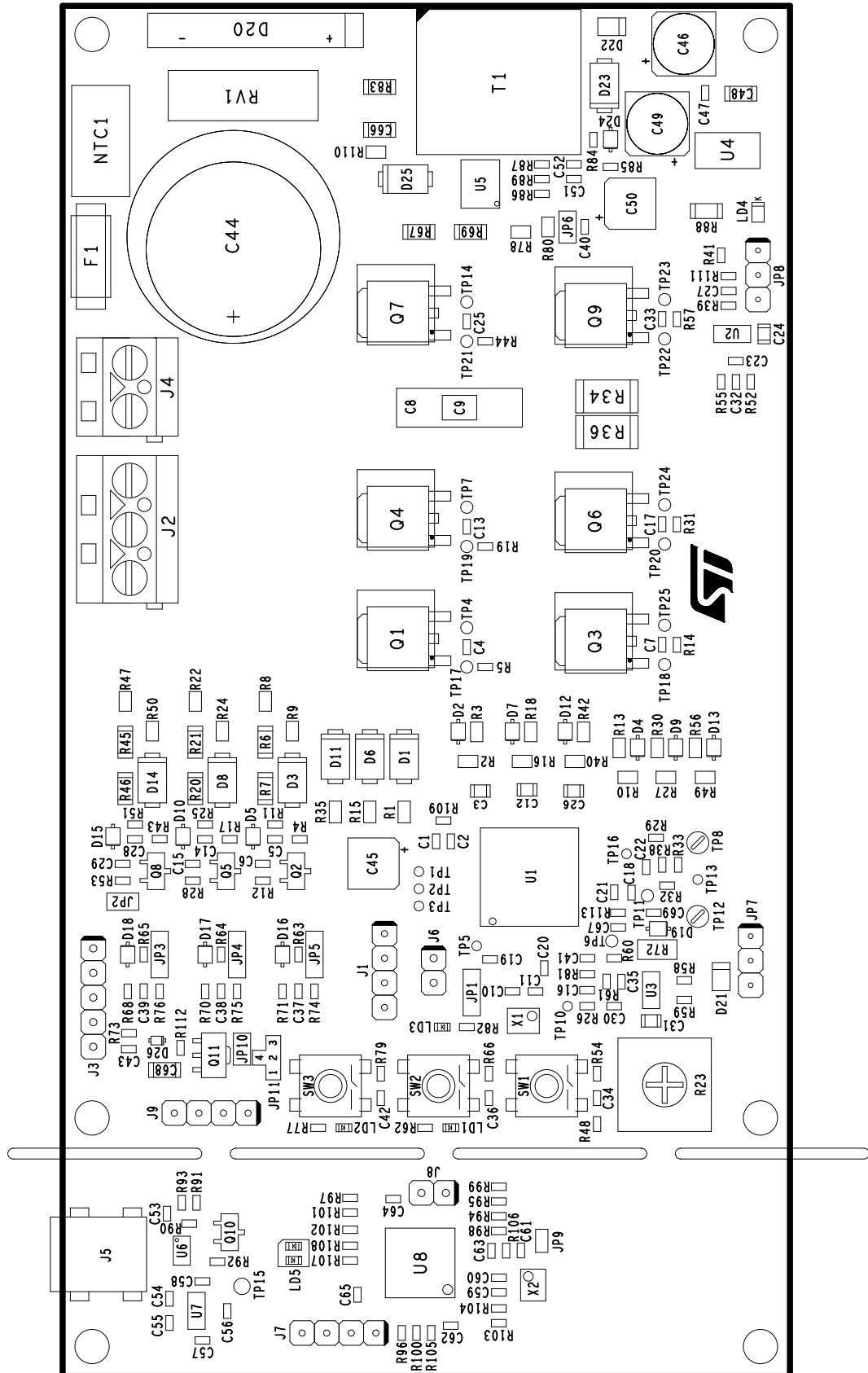

Figure 7. EVSPIN32F06021s – Layout (top layer)

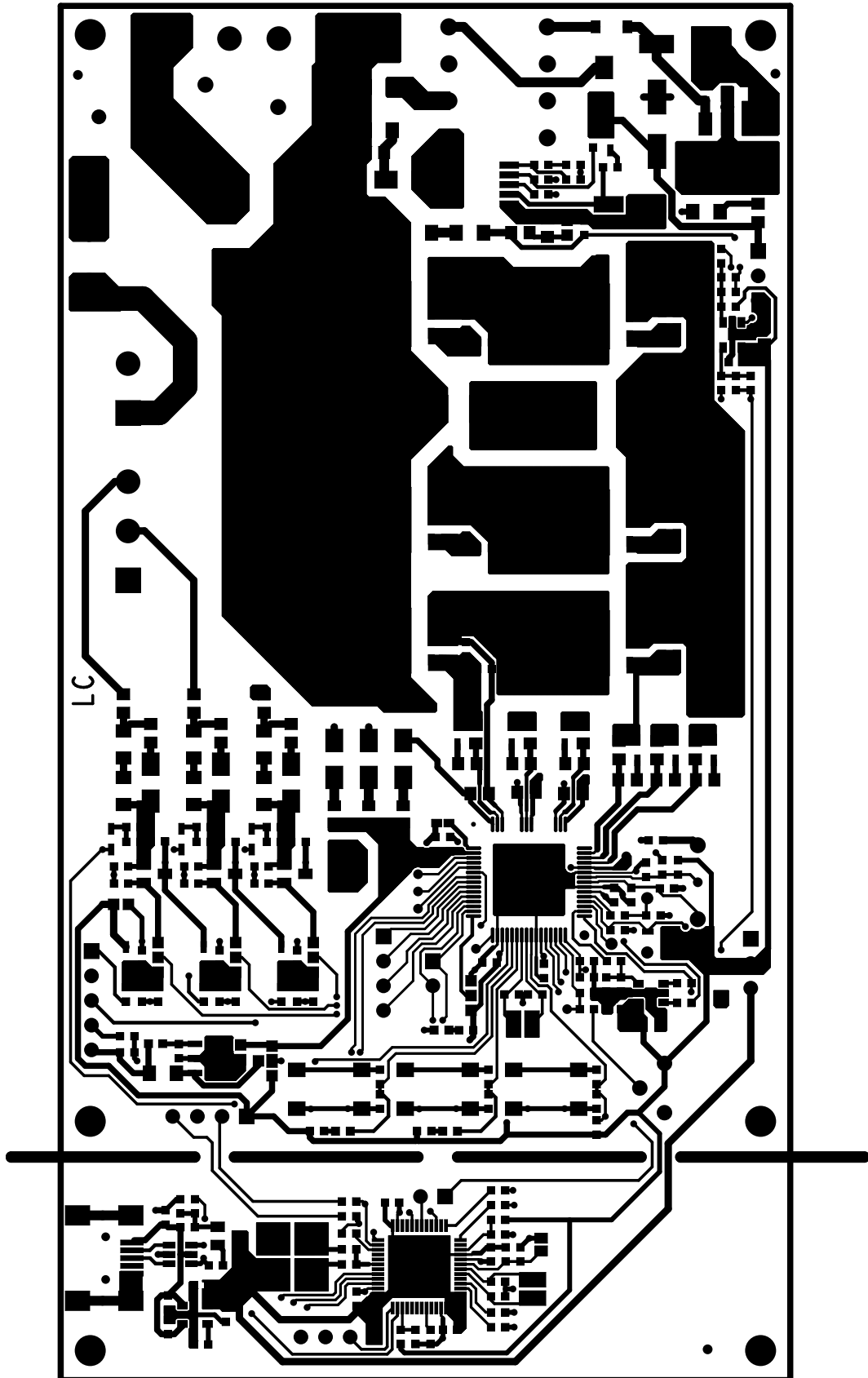
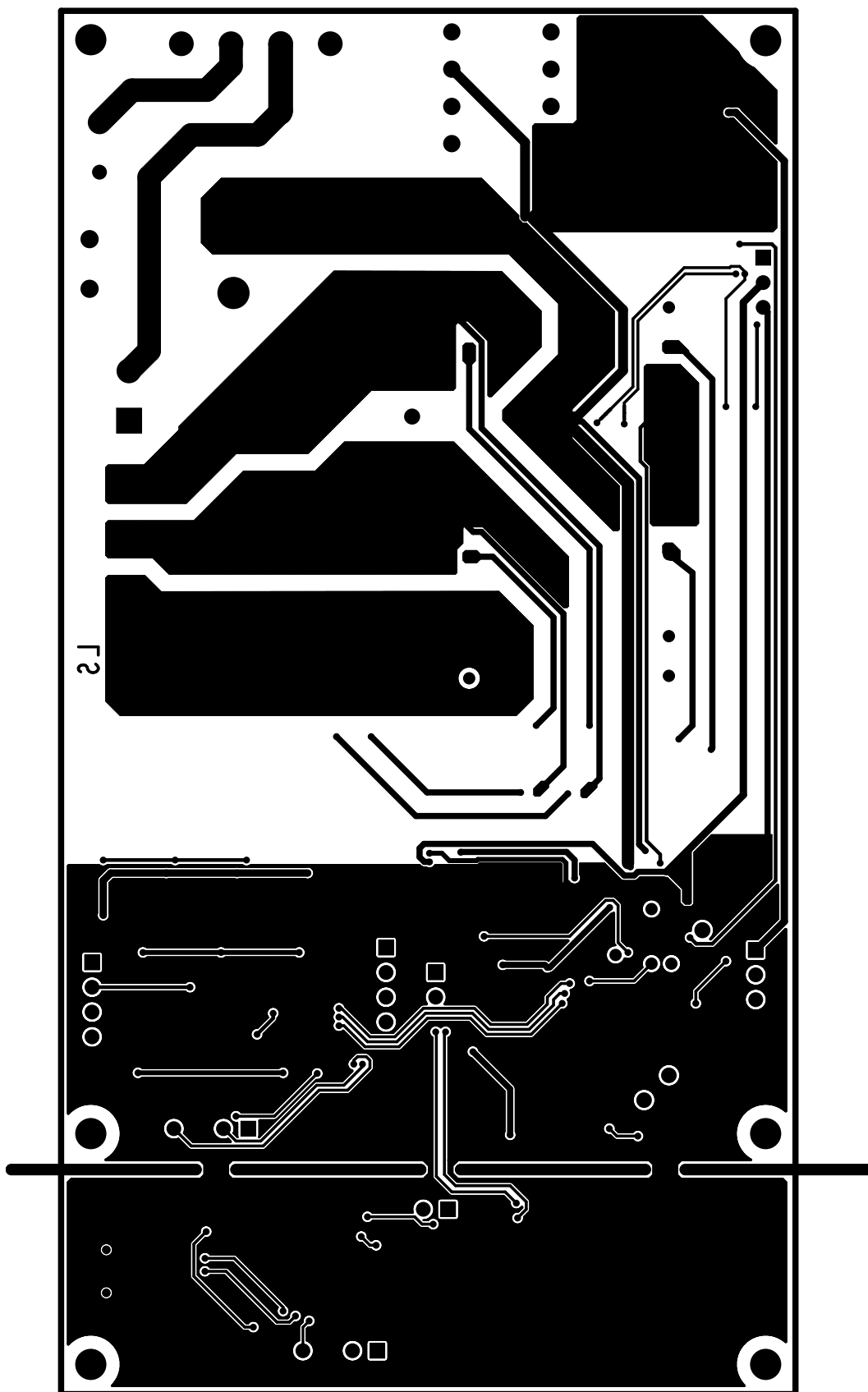



Figure 8. EVSPIN32F06021s – Layout (bottom layer)



## Revision history

**Table 2. Document revision history**

Date	Version	Changes
28-Oct-2019	1	Initial release.

## Contents

<b>1</b>	<b>Safety and operating instructions</b>	<b>3</b>
1.1	General terms	3
1.2	Intended use of evaluation board	3
1.3	Installing the evaluation board	3
1.4	Operating the evaluation board	3
<b>2</b>	<b>Schematic diagram</b>	<b>5</b>
<b>3</b>	<b>Bill of material</b>	<b>9</b>
<b>4</b>	<b>Layout and component placements</b>	<b>14</b>
	Revision history	18
	Contents	19
	List of tables	20
	List of figures	21

## List of tables

<b>Table 1.</b>	Bill of Materials – Components common to all device variants . . . . .	9
<b>Table 2.</b>	Document revision history . . . . .	18

## List of figures

<b>Figure 1.</b>	EVSPIN32F06021s schematic – Driver output stages . . . . .	5
<b>Figure 2.</b>	EVSPIN32F06021s schematic – Feedback network . . . . .	6
<b>Figure 3.</b>	EVSPIN32F06021s schematic – Power Supply. . . . .	7
<b>Figure 4.</b>	EVSPIN32F06021s schematic – STLINK debugger. . . . .	8
<b>Figure 5.</b>	EVSPIN32F06021s – Board functions description . . . . .	14
<b>Figure 6.</b>	EVSPIN32F06021s – Layout (component placement top view) . . . . .	15
<b>Figure 7.</b>	EVSPIN32F06021s – Layout (top layer). . . . .	16
<b>Figure 8.</b>	EVSPIN32F06021s – Layout (bottom layer) . . . . .	17

**IMPORTANT NOTICE – PLEASE READ CAREFULLY**

STMicroelectronics NV and its subsidiaries (“ST”) reserve the right to make changes, corrections, enhancements, modifications, and improvements to ST products and/or to this document at any time without notice. Purchasers should obtain the latest relevant information on ST products before placing orders. ST products are sold pursuant to ST’s terms and conditions of sale in place at the time of order acknowledgement.

Purchasers are solely responsible for the choice, selection, and use of ST products and ST assumes no liability for application assistance or the design of Purchasers’ products.

No license, express or implied, to any intellectual property right is granted by ST herein.

Resale of ST products with provisions different from the information set forth herein shall void any warranty granted by ST for such product.

ST and the ST logo are trademarks of ST. For additional information about ST trademarks, please refer to [www.st.com/trademarks](http://www.st.com/trademarks). All other product or service names are the property of their respective owners.

Information in this document supersedes and replaces information previously supplied in any prior versions of this document.

© 2019 STMicroelectronics – All rights reserved

# Mouser Electronics

Authorized Distributor

Click to View Pricing, Inventory, Delivery & Lifecycle Information:

[STMicroelectronics:](#)

[EVSPIN32F0602S1](#)