

# Constant Current Step-Up/ Step-Down/Inverting Switching Regulator for HB-LEDs

## 1.5 A

### NCP3065, NCV3065

The NCP3065 is a monolithic switching regulator designed to deliver constant current for powering high brightness LEDs. The device has a very low feedback voltage of 235 mV (nominal) which is used to regulate the average current of the LED string. In addition, the NCP3065 has a wide input voltage up to 40 V to allow it to operate from 12 Vac or 12 Vdc supplies commonly used for lighting applications as well as unregulated supplies such as Lead Acid batteries. The device can be configured in a controller topology with the addition of an external transistor to support higher LED currents beyond the 1.5 A rated switch current of the internal transistor. The NCP3065 switching regulator can be configured in Step-Down (Buck) and Step-Up (Boost) topologies with a minimum number of external components.

#### Features

- Integrated 1.5 A Switch
- Input Voltage Range from 3.0 V to 40 V
- Low Feedback Voltage of 235 mV
- Cycle-by-Cycle Current Limit
- No Control Loop Compensation Required
- Frequency of Operation Adjustable up to 250 kHz
- Operation with All Ceramic Output Capacitors or No Output Capacitance
- Analog and Digital PWM Dimming Capability
- Internal Thermal Shutdown with Hysteresis
- Automotive Version Available

#### Applications

- Automotive and Marine Lighting
- High Power LED Driver
- Constant Current Source
- Low Voltage LED Lighting  
(Landscape, Path, Solar, MR16 Replacement)

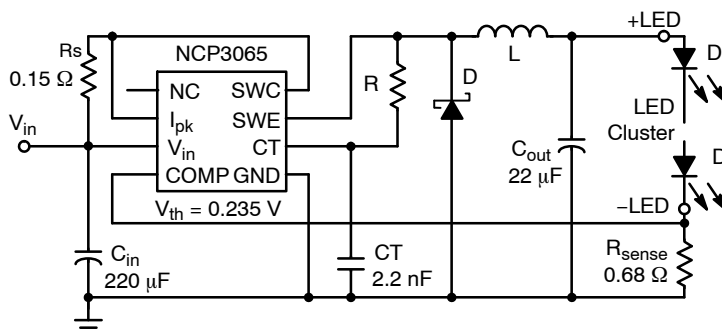
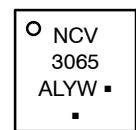
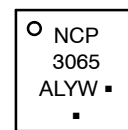
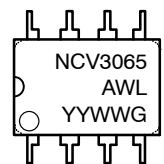
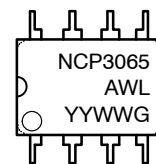
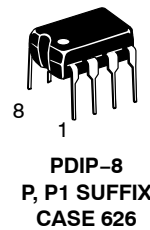
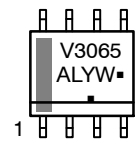
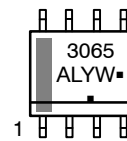


Figure 1. Typical Buck Application Circuit

#### MARKING DIAGRAMS



- A = Assembly Location
- L, WL = Wafer Lot
- Y, YY = Year
- W, WW = Work Week
- G or ■ = Pb-Free Package

(Note: Microdot may be in either location)

#### ORDERING INFORMATION

See detailed ordering and shipping information in the package dimensions section on page 15 of this data sheet.

# NCP3065, NCV3065

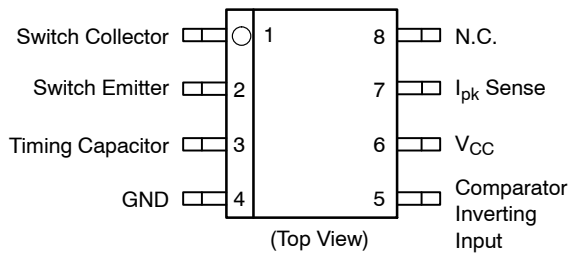


Figure 2. Pin Connections

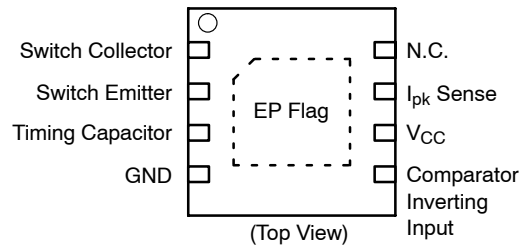


Figure 3. Pin Connections

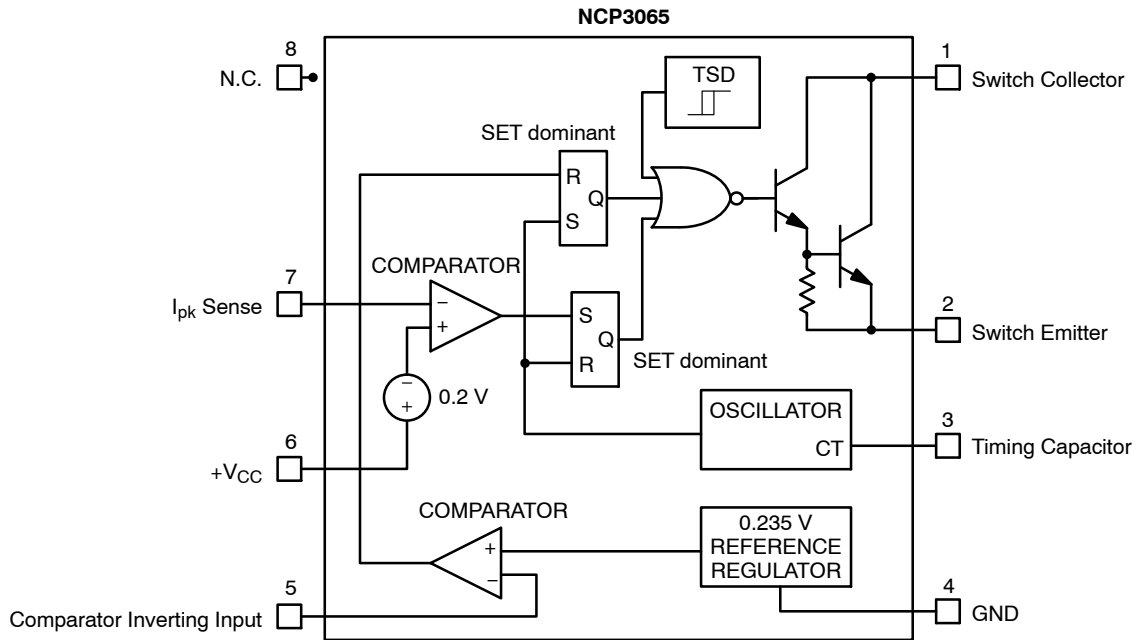


Figure 4. Block Diagram

## PIN DESCRIPTION

Pin No.	Pin Name	Description
1	Switch Collector	Internal Darlington switch collector
2	Switch Emitter	Internal Darlington switch emitter
3	Timing Capacitor	Timing Capacitor Oscillator Input, Timing Capacitor
4	GND	Ground pin for all internal circuits
5	Comparator Inverting Input	Inverting input pin of internal comparator
6	V <sub>CC</sub>	Voltage supply
7	I <sub>pk</sub> Sense	Peak Current Sense Input to monitor the voltage drop across an external resistor to limit the peak current through the circuit
8	N.C.	Pin not connected

# NCP3065, NCV3065

## MAXIMUM RATINGS (measured vs. pin 4, unless otherwise noted)

Rating	Symbol	Value	Unit
V <sub>CC</sub> (Pin 6)	V <sub>CC</sub>	0 to +40	V
Comparator Inverting Input (Pin 5)	V <sub>CI</sub>	-0.2 to +V <sub>CC</sub>	V
Darlington Switch Collector (Pin 1)	V <sub>SWC</sub>	0 to +40	V
Darlington Switch Emitter (Pin 2) (Transistor OFF)	V <sub>SWE</sub>	-0.6 to +V <sub>CC</sub>	V
Darlington Switch Collector to Emitter (Pins 1-2)	V <sub>SWCE</sub>	0 to +40	V
Darlington Switch Current	I <sub>SW</sub>	1.5	A
I <sub>pk</sub> Sense (Pin 7)	V <sub>IPK</sub>	-0.2 to V <sub>CC</sub> + 0.2	V
Timing Capacitor (Pin 3)	V <sub>TCAP</sub>	-0.2 to +1.4	V

## Power Dissipation and Thermal Characteristics

PDIP-8 Thermal Resistance Junction-to-Air	R <sub>θJA</sub>	100	°C/W
SOIC-8 Thermal Resistance Junction-to-Air	R <sub>θJA</sub>	180	°C/W
DFN-8 Thermal Resistance Junction-to-Air Thermal Resistance Junction-to-Case	R <sub>θJA</sub> R <sub>θJC</sub>	78 14	°C/W
Storage Temperature Range	T <sub>STG</sub>	-65 to +150	°C
Maximum Junction Temperature	T <sub>J(MAX)</sub>	+150	°C
Operating Junction Temperature Range (Note 3) NCP3065, NCV3065	T <sub>J</sub>	-40 to +125	°C

Stresses exceeding those listed in the Maximum Ratings table may damage the device. If any of these limits are exceeded, device functionality should not be assumed, damage may occur and reliability may be affected.

- This device series contains ESD protection and exceeds the following tests:  
Pin 1-8: Human Body Model 2000 V per AEC Q100-002; 003 or JESD22/A114; A115  
Machine Model Method 200 V
- This device contains latch-up protection and exceeds 100 mA per JEDEC Standard JESD78.
- The relation between junction temperature, ambient temperature and Total Power dissipated in IC is  $T_J = T_A + R_{\theta} \cdot P_D$
- The pins which are not defined may not be loaded by external signals

# NCP3065, NCV3065

## ELECTRICAL CHARACTERISTICS ( $V_{CC} = 5.0\text{ V}$ , $T_J = -40^\circ\text{C}$ to $+125^\circ\text{C}$ , unless otherwise specified)

Characteristic	Conditions	Symbol	Min	Typ	Max	Unit
----------------	------------	--------	-----	-----	-----	------

### OSCILLATOR

Frequency	(VPin 5 = 0 V, CT = 2.2 nF, $T_J = 25^\circ\text{C}$ )	$f_{OSC}$	110	150	190	kHz
Discharge to Charge Current Ratio	(Pin 7 to $V_{CC}$ , $T_J = 25^\circ\text{C}$ )	$I_{DISCHG} / I_{CHG}$	5.5	6.0	6.5	–
Capacitor Discharging Current	(Pin 7 to $V_{CC}$ , $T_J = 25^\circ\text{C}$ )	$I_{DISCHG}$		1650		$\mu\text{A}$
Capacitor Charging Current	(Pin 7 to $V_{CC}$ , $T_J = 25^\circ\text{C}$ )	$I_{CHG}$		275		$\mu\text{A}$
Current Limit Sense Voltage	( $T_J = 25^\circ\text{C}$ ) (Note 6)	$V_{IPK(Sense)}$	165	185	235	mV

### OUTPUT SWITCH (Note 5)

Darlington Switch Collector to Emitter Voltage Drop	( $I_{SW} = 1.0\text{ A}$ , $T_J = 25^\circ\text{C}$ ) (Note 5)	$V_{SWCE(DROP)}$		1.0	1.3	V
Collector Off–State Current	( $V_{CE} = 40\text{ V}$ )	$I_{C(OFF)}$		0.01	100	$\mu\text{A}$

### COMPARATOR

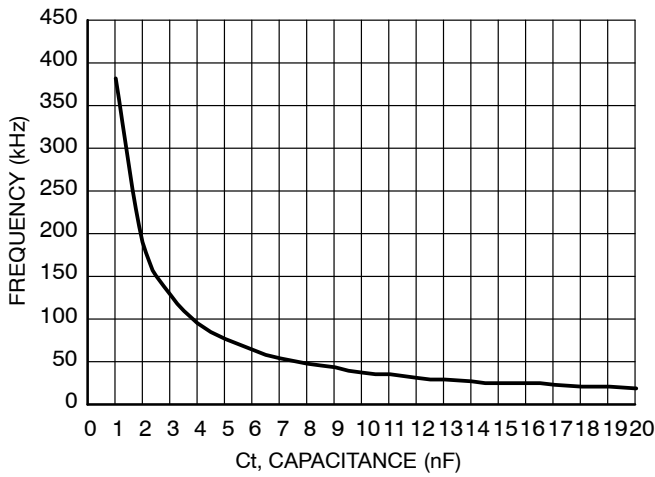
Threshold Voltage	$T_J = 25^\circ\text{C}$	$V_{TH}$		235		mV
	$T_J = 0$ to $+85^\circ\text{C}$			$\pm 5$		%
	$T_J = -40^\circ\text{C}$ to $+125^\circ\text{C}$	$V_{TH}$	–10		+10	%
Threshold Voltage Line Regulation	( $V_{CC} = 3.0\text{ V}$ to $40\text{ V}$ )	$REG_{LINE}$	–6.0		6.0	mV
Input Bias Current	( $V_{in} = V_{th}$ )	$I_{CII\ in}$	–1000	–100	1000	nA

### TOTAL DEVICE

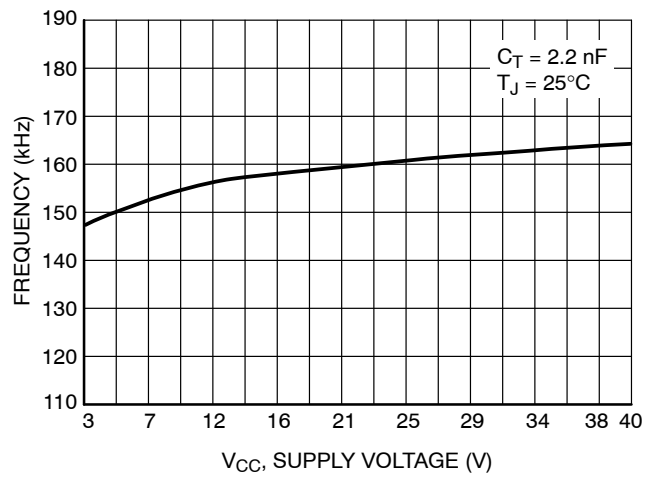
Supply Current	( $V_{CC} = 5.0\text{ V}$ to $40\text{ V}$ , CT = 2.2 nF, Pin 7 = $V_{CC}$ , VPin 5 > $V_{th}$ , Pin 2 = GND, remaining pins open)	$I_{CC}$			7.0	mA
Thermal Shutdown Threshold				160		$^\circ\text{C}$
Hysteresis				10		$^\circ\text{C}$

5. Low duty cycle pulse techniques are used during test to maintain junction temperature as close to ambient temperature as possible.
6. The  $V_{IPK(Sense)}$  Current Limit Sense Voltage is specified at static conditions. In dynamic operation the sensed current turn–off value depends on comparator response time and di/dt current slope. See the Operating Description section for details.
7. NCV prefix is for automotive and other applications requiring site and change control.

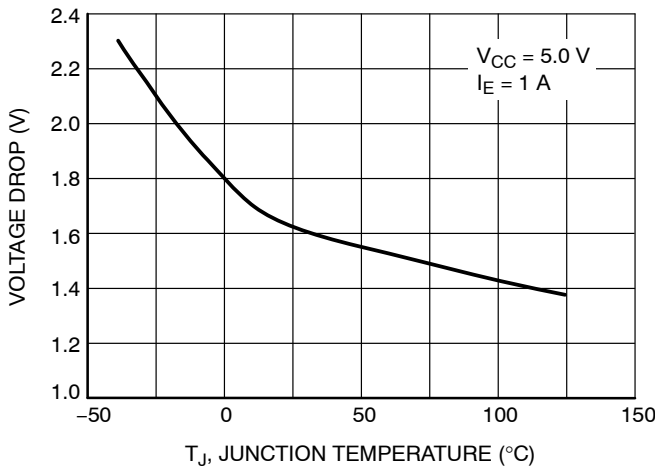
# NCP3065, NCV3065



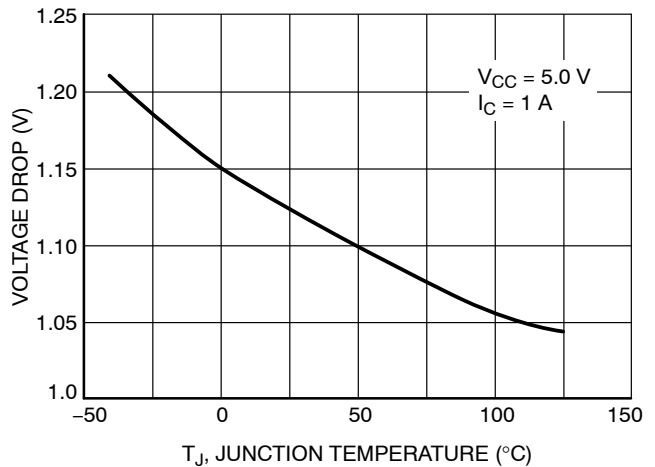
**Figure 5. Oscillator Frequency vs. Oscillator Timing Capacitor**



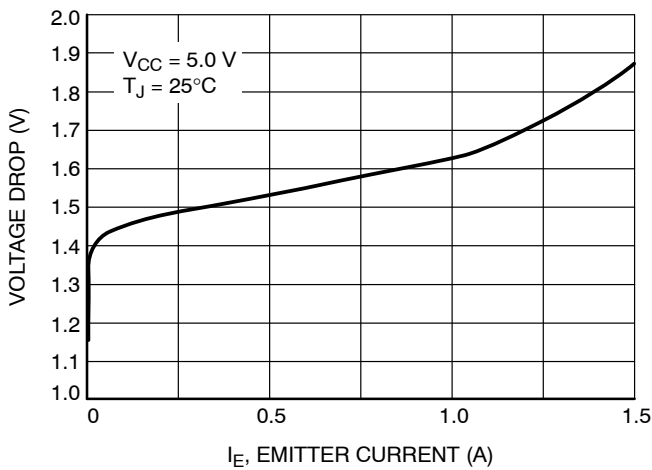
**Figure 6. Oscillator Frequency vs. Supply Voltage**



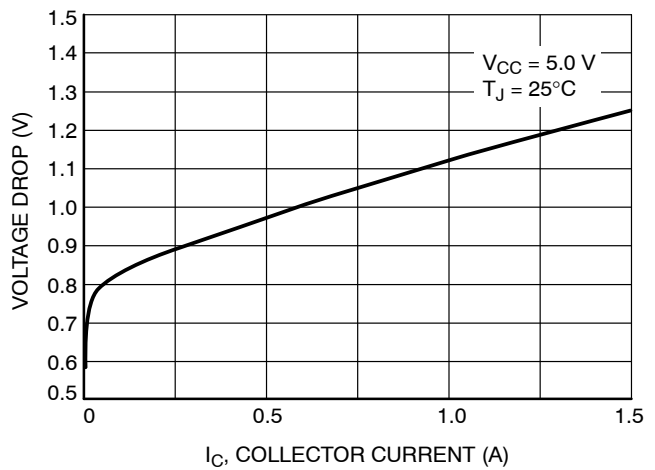
**Figure 7. Emitter Follower Configuration Output Darlington Switch Voltage Drop vs. Temperature**



**Figure 8. Common Emitter Configuration Output Darlington Switch Voltage Drop vs. Temperature**

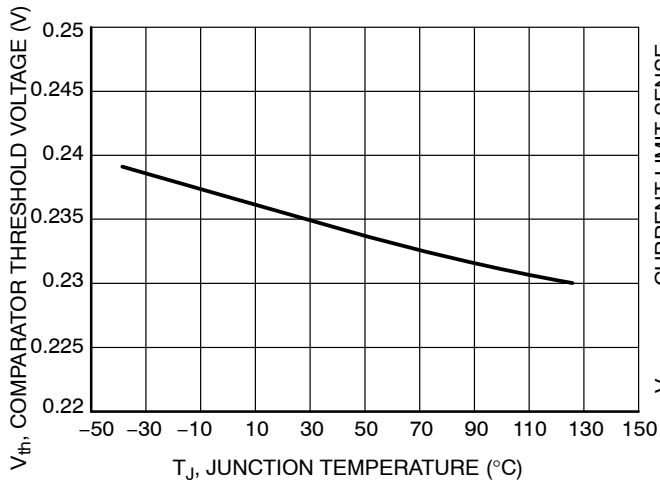


**Figure 9. Emitter Follower Configuration Output Darlington Switch Voltage Drop vs. Emitter Current**

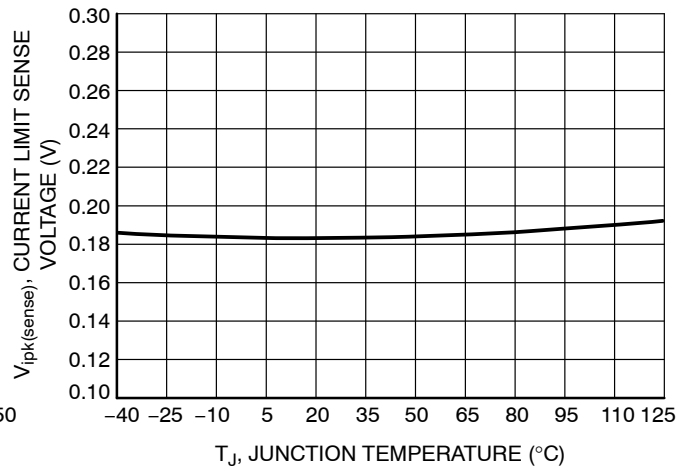


**Figure 10. Common Emitter Configuration Output Darlington Switch Voltage Drop vs. Collector Current**

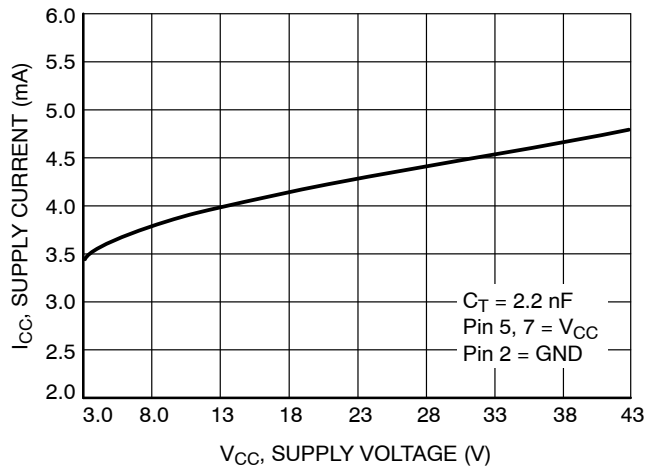
# NCP3065, NCV3065



**Figure 11. Comparator Threshold Voltage vs. Temperature**



**Figure 12. Current Limit Sense Voltage vs. Temperature**



**Figure 13. Standby Supply Current vs. Supply Voltage**

## INTRODUCTION

The NCP3065 is a monolithic power switching regulator optimized for LED Driver applications. Its flexible architecture enables the system designer to directly implement a step-up or step-down topology with a minimum number of external components for driving LEDs. A representative block diagram is shown in Figure 4.

### OPERATING DESCRIPTION

The NCP3065 operates as a fixed oscillator frequency output voltage ripple gated regulator. In general, this mode of operation is somewhat analogous to a capacitor charge pump and does not require dominant pole loop compensation for converter stability. The typical operating waveforms are shown in Figure 14. The output voltage waveform shown is for a step-down converter with the ripple and phasing exaggerated for clarity. During initial converter startup, the feedback comparator senses that the output voltage level is below nominal. This causes the output switch to turn on and off at a frequency and duty cycle controlled by the oscillator, thus pumping up the output filter capacitor. When the feedback voltage level reaches nominal

comparator value, the output switch cycle is inhibited. When the load current causes the output voltage to fall below the nominal value feedback comparator enables switching immediately. Under these conditions, the output switch conduction can be enabled for a partial oscillator cycle, a partial cycle plus a complete cycle, multiple cycles, or a partial cycle plus multiple cycles.

### Oscillator

The oscillator frequency and off-time of the output switch are programmed by the value of the timing capacitor  $C_T$ . Capacitor  $C_T$  is charged and discharged by a 1 to 6 ratio internal current source and sink, generating a positive going sawtooth waveform at Pin 3. This ratio sets the maximum  $t_{ON}/(t_{ON}+t_{OFF})$  of the switching converter as  $6/(6+1)$  or 85.7% (typical). The oscillator peak and valley voltage difference is 500 mV typically. To calculate the  $C_T$  capacitor value for required oscillator frequency, use the equations found in Figure 22. An online NCP3065 design tool can be found at [www.onsemi.com](http://www.onsemi.com), which adds in selecting component values.

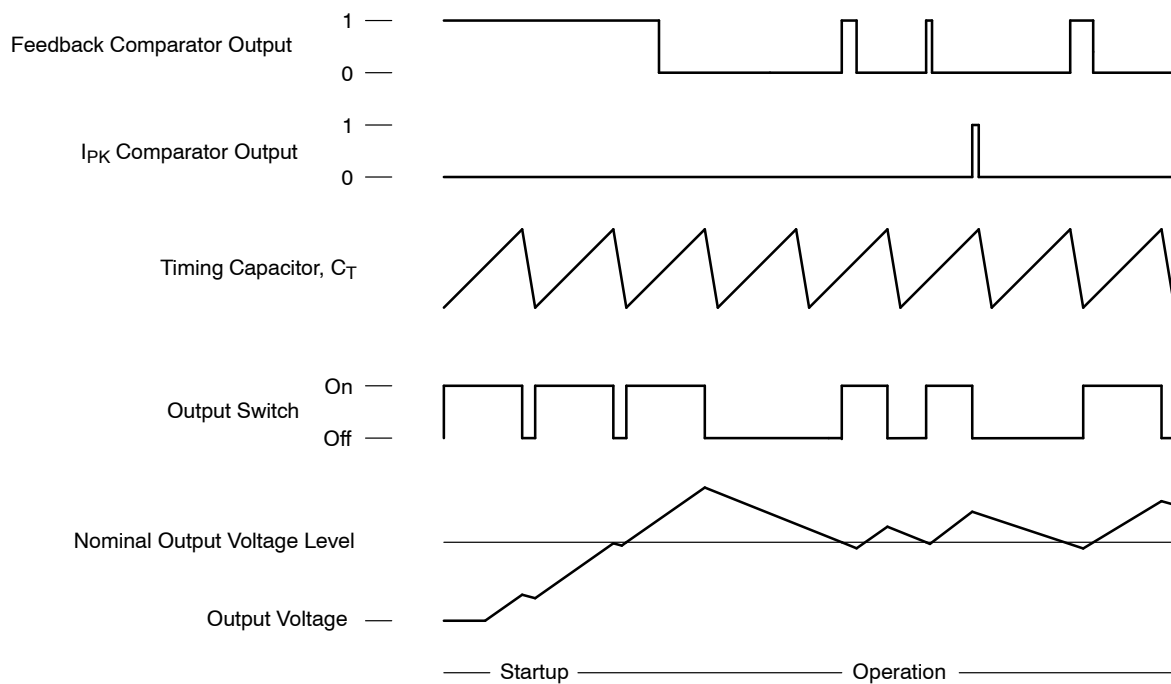
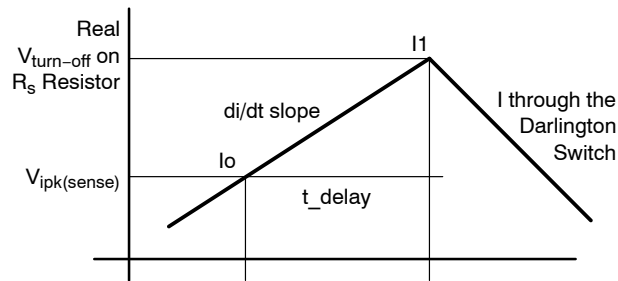


Figure 14. Typical Operating Waveforms

**Peak Current Sense Comparator**

Under normal conditions, the output switch conduction is initiated by the Voltage Feedback comparator and terminated by the oscillator. Abnormal operating conditions occur when the converter output is overloaded or when feedback voltage sensing is lost. Under these conditions, the  $I_{pk}$  Current Sense comparator will protect the Darlington output Switch. The switch current is converted to a voltage by inserting a fractional ohm resistor,  $R_{SC}$ , in series with  $V_{CC}$  and the Darlington output switch. The voltage drop across  $R_{SC}$  is monitored by the Current Sense comparator. If the voltage drop exceeds 200 mV (nom) with respect to  $V_{CC}$ , the comparator will set the latch and terminate the output switch conduction on a cycle-by-cycle basis. This Comparator/Latch configuration ensures that the Output Switch has only a single on-time during a given oscillator cycle.



The  $V_{IPK(Sense)}$  Current Limit Sense Voltage threshold is specified at static conditions. In dynamic operation the sensed current turn-off value depends on comparator response time and di/dt current slope.

Real  $V_{turn-off}$  on  $R_{sc}$  resistor

$$V_{turn\_off} = V_{ipk(sense)} + R_{sc} \cdot (t_{delay} \cdot di/dt)$$

Typical  $I_{pk}$  comparator response time  $t_{delay}$  is 350 ns. The di/dt current slope is dependent on the voltage difference across the inductor and the value of the inductor. Increasing the value of the inductor will reduce the di/dt slope.

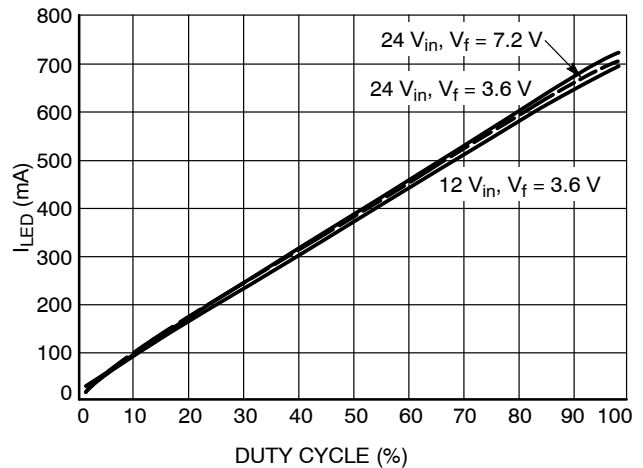
It is recommended to verify the actual peak current in the application at worst conditions to be sure that the max peak current will never get over the 1.5 A Darlington Switch Current max rating.

**Thermal Shutdown**

Internal thermal shutdown circuitry is provided to protect the IC in the event that the maximum junction temperature is exceeded. When activated, typically at 165°C, the Darlington Output Switch is disabled. The temperature sensing circuit is designed with some hysteresis. The Darlington Switch is enabled again when the chip temperature decreases under the low threshold. This feature is provided to prevent catastrophic failures from accidental device overheating. It is not intended to be used as a replacement for proper heatsinking.

**LED Dimming**

The COMP pin of the NCP3065 is used to provide dimming capability. In digital input mode the PWM input signal inhibits switching of the regulator and reduces the average current through the LEDs. In analog input mode a PWM input signal is RC filtered and the resulting voltage is summed with the feedback voltage thus reduces the average current through the LEDs. Figure 15 illustrated the linearity of the digital dimming function with a 200 Hz digital PWM. For further information on dimming control refer to application note AND8298.



**Figure 15.**

**No Output Capacitor Operation**

A constant current buck regulator such as the NCP3065 focuses on the control of the current through the load, not the voltage across it. The switching frequency of the NCP3065 is in the range of 100–250 kHz which is much higher than the human eye can detect. This allows us to relax the ripple current specification to allow higher peak to peak values. This is achieved by configuring the NCP3065 in a continuous conduction buck configuration with low peak to peak ripple thus eliminating the need for an output filter capacitor. The important design parameter is to keep the peak current below the maximum current rating of the LED. Using 15% peak to peak ripple results in a good compromise between achieving max average output current without exceeding the maximum limit. This saves space and reduces part count for applications that require a compact footprint. (Example: See Figure 17) See application note AND8298 for more information.

**Output Switch**

The output switch is designed in a Darlington configuration. This allows the application designer to operate at all conditions at high switching speed and low voltage drop. The Darlington Output Switch is designed to switch a maximum of 40 V collector to emitter voltage and current up to 1.5 A.



APPLICATIONS

Figures 16 through 24 show the simplicity and flexibility of the NCP3065. Two main converter topologies are demonstrated with actual test data shown below each of the circuit diagrams.

Figure 16 gives the relevant design equations for the key parameters. Additionally, a complete application design aid for the NCP3065 can be found at [www.onsemi.com](http://www.onsemi.com).

(See Notes 8, 9, 10)	Step-Down	Step-Up
$\frac{t_{on}}{t_{off}}$	$\frac{V_{out} + V_F}{V_{in} - V_{SWCE} - V_{out}}$	$\frac{V_{out} + V_F - V_{in}}{V_{in} - V_{SWCE}}$
$t_{on}$	$\frac{\frac{t_{on}}{t_{off}}}{f \left( \frac{t_{on}}{t_{off}} + 1 \right)}$	$\frac{\frac{t_{on}}{t_{off}}}{f \left( \frac{t_{on}}{t_{off}} + 1 \right)}$
$C_T$	$C_T = \frac{381.6 \cdot 10^{-6}}{f_{osc}} - 343 \cdot 10^{-12}$	
$I_{L(avg)}$	$I_{out}$	$I_{out} \left( \frac{t_{on}}{t_{off}} + 1 \right)$
$I_{pk (Switch)}$	$I_{L(avg)} + \frac{\Delta I_L}{2}$	$I_{L(avg)} + \frac{\Delta I_L}{2}$
$R_{SC}$	$\frac{0.20}{I_{pk (Switch)}}$	$\frac{0.20}{I_{pk (Switch)}}$
$L$	$\left( \frac{V_{in} - V_{SWCE} - V_{out}}{\Delta I_L} \right) t_{on}$	$\left( \frac{V_{in} - V_{SWCE}}{\Delta I_L} \right) t_{on}$
$V_{ripple(pp)}$	$\Delta I_L \sqrt{\left( \frac{1}{8 f C_O} \right)^2 + (ESR)^2}$	$\approx \frac{t_{on} I_{out}}{C_O} + \Delta I_L \cdot ESR$
$V_{out}$	$V_{TH} \left( \frac{R_2}{R_1} + 1 \right)$	$V_{TH} \left( \frac{R_2}{R_1} + 1 \right)$
$I_{out}$	$V_{ref}/R_{sense}$	$V_{ref}/R_{sense}$

- 8.  $V_{SWCE}$  – Darlingon Switch Collector to Emitter Voltage Drop, refer to Figures 7, 8, 9 and 10.
- 9.  $V_F$  – Output rectifier forward voltage drop. Typical value for 1N5819 Schottky barrier rectifier is 0.4 V.
- 10. The calculated  $t_{on}/t_{off}$  must not exceed the minimum guaranteed oscillator charge to discharge ratio.

Figure 16. Design Equations

The Following Converter Characteristics Must Be Chosen:

$V_{in}$  – Nominal operating input voltage.

$V_{out}$  – Desired output voltage.

$I_{out}$  – Desired output current.

$\Delta I_L$  – Desired peak-to-peak inductor ripple current. For maximum output current it is suggested that  $\Delta I_L$  be chosen to be less than 10% of the average inductor current  $I_{L(avg)}$ . This will help prevent  $I_{pk (Switch)}$  from reaching the current limit threshold set by  $R_{SC}$ . If the design goal is to use a minimum inductance value, let  $\Delta I_L = 2(I_{L(avg)})$ . This will proportionally reduce converter output current capability.

$f$  – Maximum output switch frequency.

$V_{ripple(pp)}$  – Desired peak-to-peak output ripple voltage. For best performance the ripple voltage should be kept to a low value since it will directly affect line and load regulation. Capacitor  $C_O$  should be a low equivalent series resistance (ESR) electrolytic designed for switching regulator applications.



# NCP3065, NCV3065

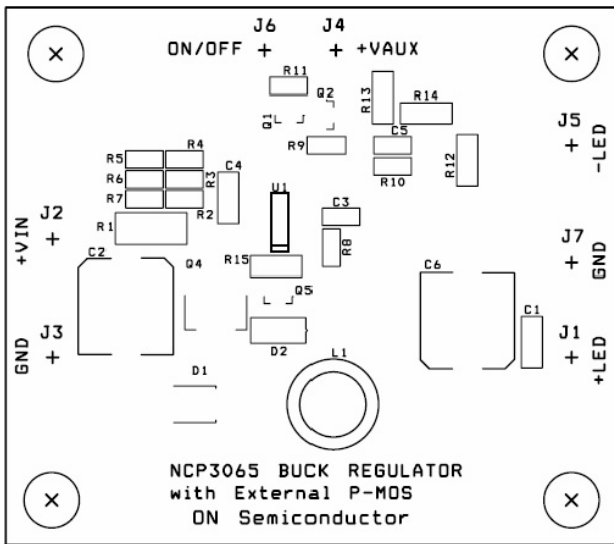


Figure 18. 1.5 A Buck Demoboard Layout

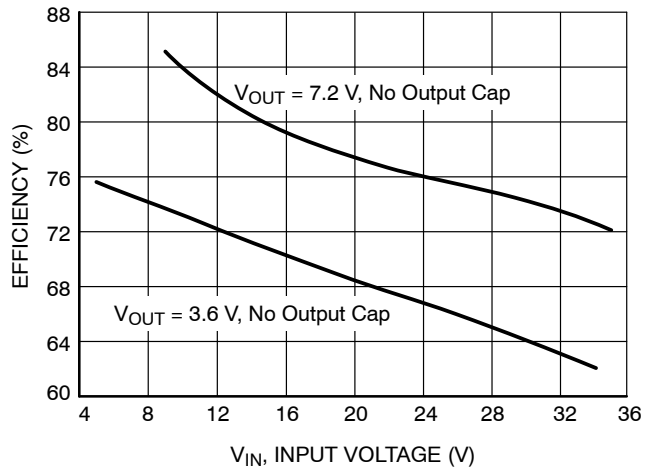


Figure 19. Efficiency vs. Input Voltage for the 1.5 A Buck Demo Board at  $I_{out} = 700\text{ mA}$ ,  $T_A = 25^\circ\text{C}$ , Without Output Capacitor

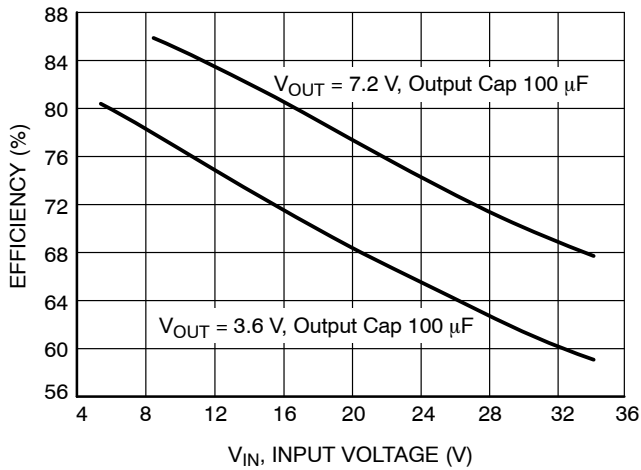


Figure 20. Efficiency vs. Input Voltage for the 1.5 A Buck Demo Board at  $I_{out} = 350\text{ mA}$ ,  $T_A = 25^\circ\text{C}$ , with  $100\ \mu\text{F}$  Output Capacitor

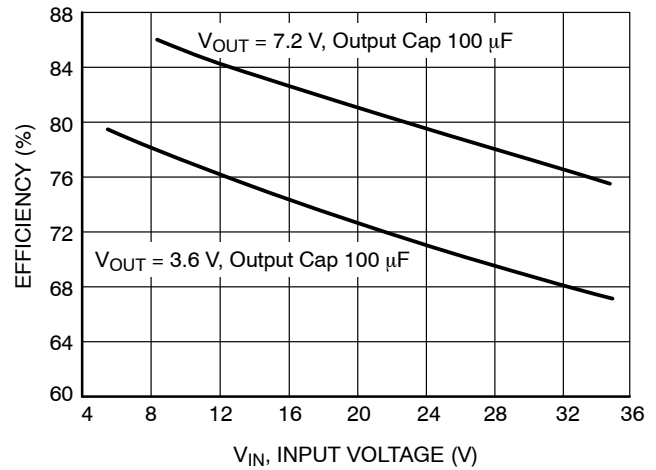
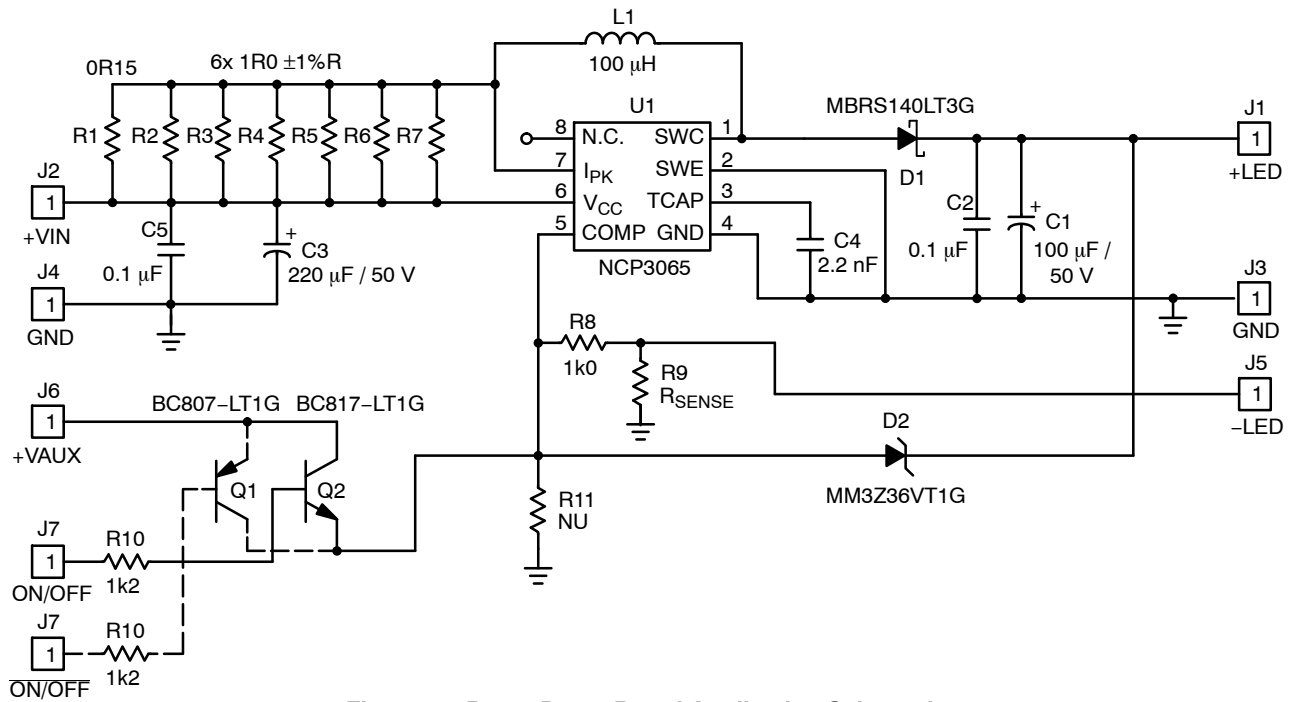


Figure 21. Efficiency vs. Input Voltage for the 1.5 A Buck Demo Board at  $I_{out} = 700\text{ mA}$ ,  $T_A = 25^\circ\text{C}$ , with  $100\ \mu\text{F}$  Output Capacitor

## NCP3065, NCV3065



**Figure 22. Boost Demo Board Application Schematic**

### Value of Components

Name	Value
C1	100 μF/50 V, Electrolytic Capacitor
C2, C5	100 nF, Ceramic Capacitor, 1206
C3	220 μF/50 V, Electrolytic Capacitor
C4	2.2 nF, Ceramic Capacitor, 0805
D1	MBRS140LT3G, Schottky diode
D2	MMSZ36VT1G, Zener diode
L1	100 μH, DO3340P-104ML Coilcraft Inductor

Name	Value
Q2	BC817-LT1G, SOT23
R1	150 mΩ, resistor 0.5 W
R8	1 k, resistor 0805
R9	Load current sense resistor, 1206
R10	1.2 k, resistor 0805
U1	NCP3065, SOIC8

### Test Results

Test	Condition	Results
Line Regulation	$V_{in} = 10 \text{ V to } 20 \text{ V}$ , $V_o = 22 \text{ V}$ , $I_{OAVG} = 350 \text{ mA}$	25 mA
Output Ripple	$V_{in} = 8 \text{ V to } 20 \text{ V}$ , $V_o = 22 \text{ V}$ , $I_{OAVG} = 350 \text{ mA}$	50 mA
Efficiency	$V_{in} = 10 \text{ to } 20 \text{ V}$ , $I_{OAVG} = 350 \text{ mA}$	> 83 %

# NCP3065, NCV3065

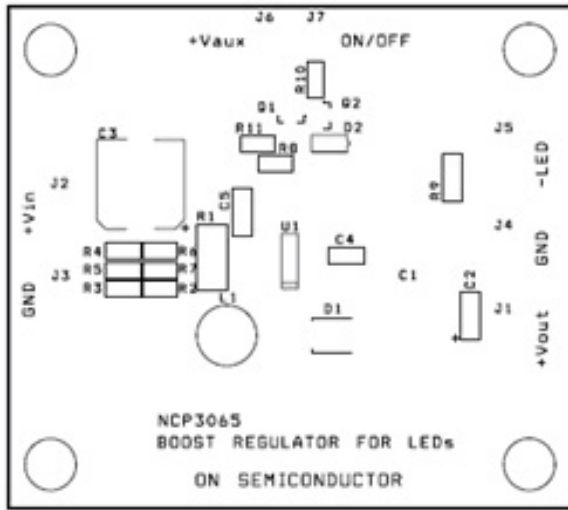


Figure 23. Boost Demoboard Layout

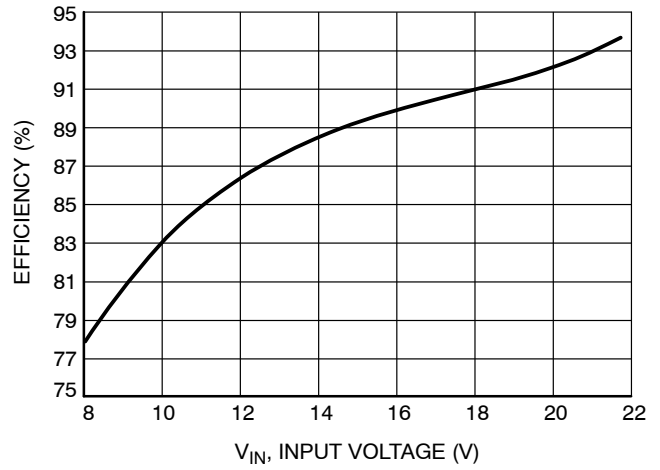
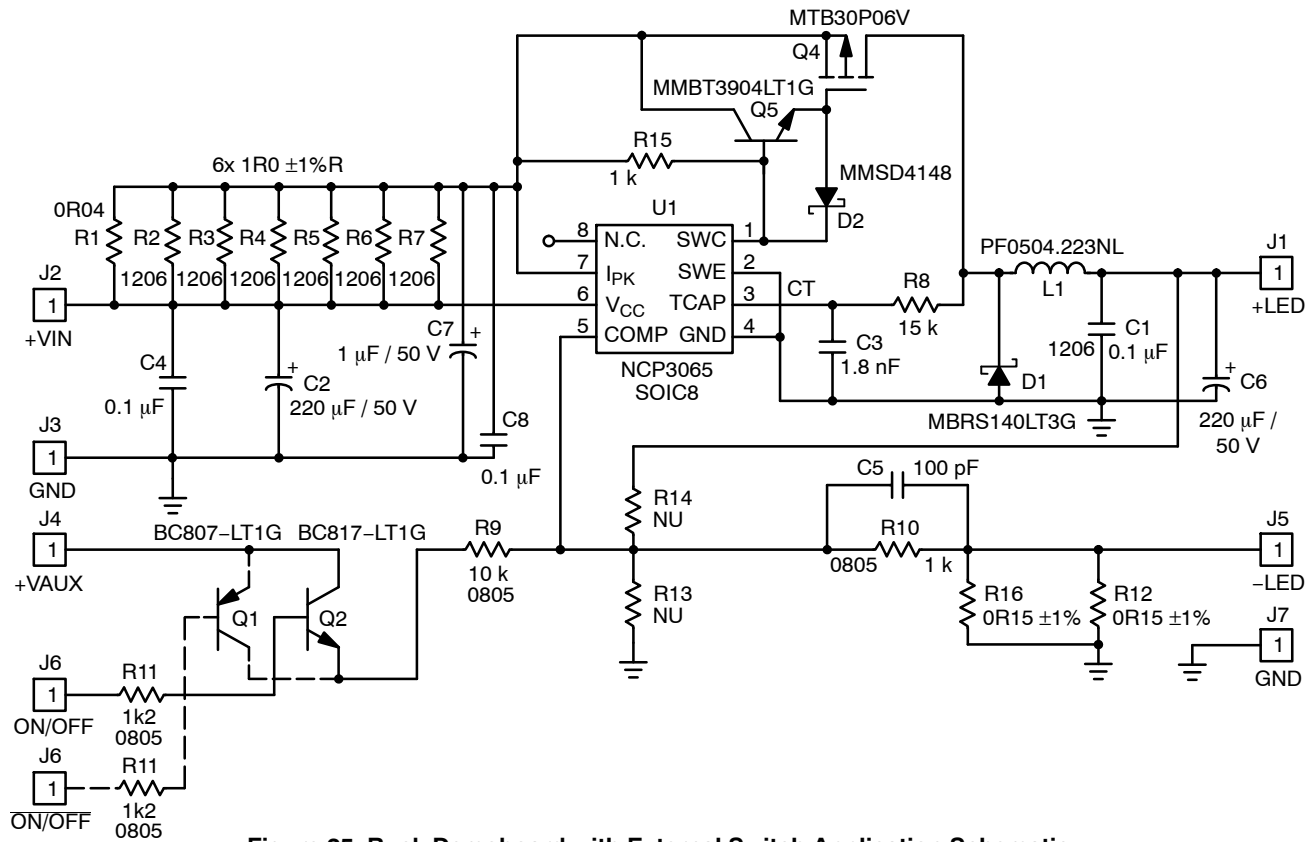


Figure 24. Efficiency vs. Input Voltage for the Boost Demo Board at  $I_{OUT} = 350 \text{ mA}$ ,  $V_{OUT} = 22 \text{ V}$  (6xLED with  $V_F = 3.6 \text{ V}$ ),  $T_A = 25^\circ\text{C}$

## NCP3065, NCV3065



**Figure 25. Buck Demoboard with External Switch Application Schematic**

### Value of Components

Name	Value
C1	100 $\mu$ F, 50 V, Electrolytic Capacitor
C1, C4, C8	100 nF, Ceramic Capacitor, 1206
C2, C6	220 $\mu$ F, 50 V, Electrolytic Capacitor
C3	2.2 nF, Ceramic Capacitor, 0805
C5	100 pF, Ceramic Capacitor, 0805
C7	1 $\mu$ F / 50 V, Ceramic Capacitor, 1206
D1	MBRS540LT3G, Schottky Diode
D2	MMSD4148T1G, Diode
L1	22 $\mu$ H
Q2	BC817-LT1G, SOT23

Name	Value
Q4	MTB30P06V, P-MOS transistor
Q5	MMBT3904LT1G
R1	40 m $\Omega$ , Resistor 0.5 W
R8	6k8, Resistor 0805
R9	10k, Resistor 0805
R10	1k, Resistor 0805
R11	1k2, Resistor 0805
R12, R16	150 m $\Omega$ , Resistor 0.5 W
U1	NCP3065, SOIC8

### Test Results

Test	Condition	Results
Line Regulation	$V_{in} = 8 \text{ V to } 19 \text{ V}$ , $I_o = 3000 \text{ mA}$	< 6%
Output Ripple	$V_{in} = 12 \text{ V}$ , $I_o = 3000 \text{ mA}$	< 6%
Efficiency	$V_{in} = 12 \text{ V}$ , $I_o = 3000 \text{ mA}$	> 78%
Short Circuit Current	$V_{in} = 12 \text{ V}$ , $R_{load} = 0.15 \Omega$	

## NCP3065, NCV3065

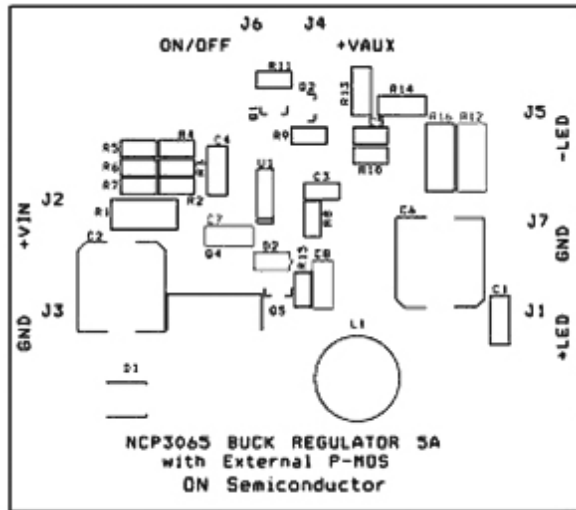


Figure 26. 3 A Buck Demoboard Layout

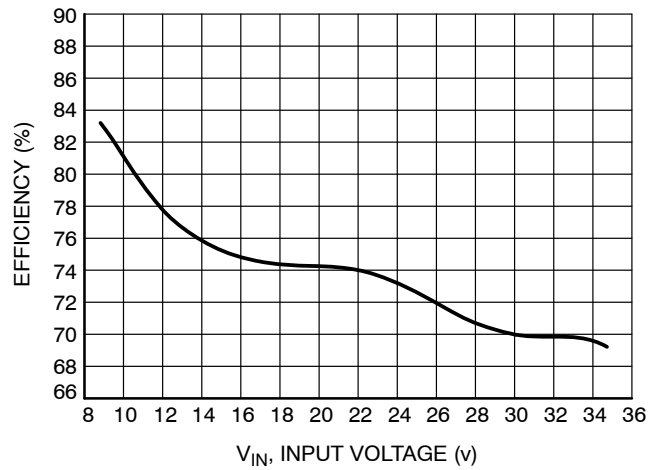


Figure 27. Efficiency vs. Input Voltage for the 3 A Buck Demo Board at  $I_{OUT} = 3\text{ A}$ ,  $V_{OUT} = 4\text{ V}$ ,  $T_A = 25^\circ\text{C}$

### ORDERING INFORMATION

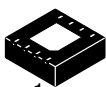
Device	Package	Shipping <sup>†</sup>
NCP3065MNTXG	DFN-8 (Pb-Free)	4000 Units / Tape & Reel
NCP3065PG	PDIP-8 (Pb-Free)	50 Units / Rail
NCP3065DR2G	SOIC-8 (Pb-Free)	2500 Units / Tape & Reel
NCV3065MNTXG	DFN-8 (Pb-Free)	4000 Units / Tape & Reel
NCV3065PG	PDIP-8 (Pb-Free)	50 Units / Rail
NCV3065DR2G	SOIC-8 (Pb-Free)	2500 Units / Tape & Reel

<sup>†</sup>For information on tape and reel specifications, including part orientation and tape sizes, please refer to our Tape and Reel Packaging Specifications Brochure, BRD8011/D.

# MECHANICAL CASE OUTLINE

## PACKAGE DIMENSIONS

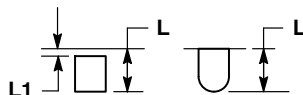
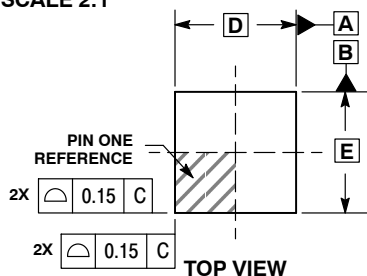
ON Semiconductor®



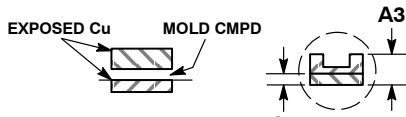
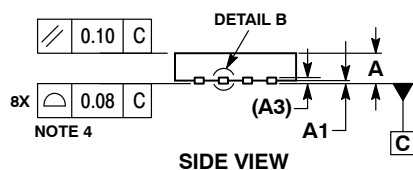
SCALE 2:1

### DFN8, 4x4 CASE 488AF-01 ISSUE C

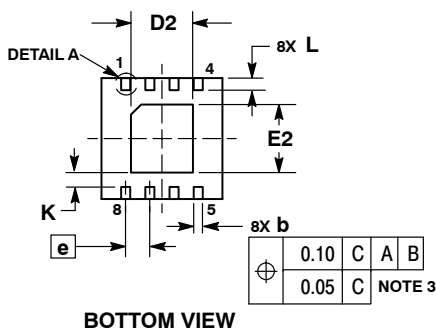
DATE 15 JAN 2009



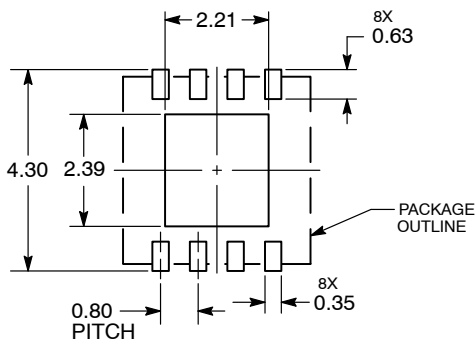
DETAIL A  
OPTIONAL  
CONSTRUCTIONS



DETAIL B  
ALTERNATE  
CONSTRUCTIONS



### SOLDERING FOOTPRINT\*

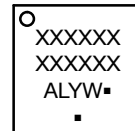


DIMENSIONS: MILLIMETERS

- NOTES:
1. DIMENSIONS AND TOLERANCING PER ASME Y14.5M, 1994.
  2. CONTROLLING DIMENSION: MILLIMETERS.
  3. DIMENSION b APPLIES TO PLATED TERMINAL AND IS MEASURED BETWEEN 0.15 AND 0.30MM FROM TERMINAL TIP.
  4. COPLANARITY APPLIES TO THE EXPOSED PAD AS WELL AS THE TERMINALS.
  5. DETAILS A AND B SHOW OPTIONAL CONSTRUCTIONS FOR TERMINALS.

MILLIMETERS		
DIM	MIN	MAX
A	0.80	1.00
A1	0.00	0.05
A3	0.20	REF
b	0.25	0.35
D	4.00	BSC
D2	1.91	2.21
E	4.00	BSC
E2	2.09	2.39
e	0.80	BSC
K	0.20	---
L	0.30	0.50
L1	---	0.15

### GENERIC MARKING DIAGRAM\*



- XXXX = Specific Device Code
- A = Assembly Location
- L = Wafer Lot
- Y = Year
- W = Work Week
- = Pb-Free Package

(Note: Microdot may be in either location)

\*This information is generic. Please refer to device data sheet for actual part marking. Pb-Free indicator, "G" or microdot "▪", may or may not be present.

\*For additional information on our Pb-Free strategy and soldering details, please download the ON Semiconductor Soldering and Mounting Techniques Reference Manual, SOLDERRM/D.

DOCUMENT NUMBER:	98AON15232D	Electronic versions are uncontrolled except when accessed directly from the Document Repository. Printed versions are uncontrolled except when stamped "CONTROLLED COPY" in red.
DESCRIPTION:	DFN8, 4X4, 0.8P	PAGE 1 OF 1

ON Semiconductor and ON are trademarks of Semiconductor Components Industries, LLC dba ON Semiconductor or its subsidiaries in the United States and/or other countries. ON Semiconductor reserves the right to make changes without further notice to any products herein. ON Semiconductor makes no warranty, representation or guarantee regarding the suitability of its products for any particular purpose, nor does ON Semiconductor assume any liability arising out of the application or use of any product or circuit, and specifically disclaims any and all liability, including without limitation special, consequential or incidental damages. ON Semiconductor does not convey any license under its patent rights nor the rights of others.



# MECHANICAL CASE OUTLINE PACKAGE DIMENSIONS

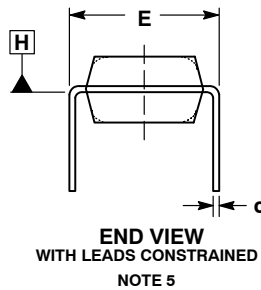
ON Semiconductor®



SCALE 1:1

PDIP-8  
CASE 626-05  
ISSUE P

DATE 22 APR 2015

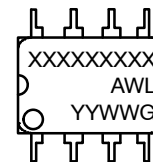


NOTES:

1. DIMENSIONING AND TOLERANCING PER ASME Y14.5M, 1994.
2. CONTROLLING DIMENSION: INCHES.
3. DIMENSIONS A, A1 AND L ARE MEASURED WITH THE PACKAGE SEATED IN JEDEC SEATING PLANE GAUGE GS-3.
4. DIMENSIONS D, D1 AND E1 DO NOT INCLUDE MOLD FLASH OR PROTRUSIONS. MOLD FLASH OR PROTRUSIONS ARE NOT TO EXCEED 0.10 INCH.
5. DIMENSION E IS MEASURED AT A POINT 0.015 BELOW DATUM PLANE H WITH THE LEADS CONSTRAINED PERPENDICULAR TO DATUM C.
6. DIMENSION eB IS MEASURED AT THE LEAD TIPS WITH THE LEADS UNCONSTRAINED.
7. DATUM PLANE H IS COINCIDENT WITH THE BOTTOM OF THE LEADS, WHERE THE LEADS EXIT THE BODY.
8. PACKAGE CONTOUR IS OPTIONAL (ROUNDED OR SQUARE CORNERS).

DIM	INCHES		MILLIMETERS	
	MIN	MAX	MIN	MAX
A	----	0.210	----	5.33
A1	0.015	----	0.38	----
A2	0.115	0.195	2.92	4.95
b	0.014	0.022	0.35	0.56
b2	0.060 TYP		1.52 TYP	
C	0.008	0.014	0.20	0.36
D	0.355	0.400	9.02	10.16
D1	0.005	----	0.13	----
E	0.300	0.325	7.62	8.26
E1	0.240	0.280	6.10	7.11
e	0.100 BSC		2.54 BSC	
eB	----	0.430	----	10.92
L	0.115	0.150	2.92	3.81
M	----	10°	----	10°

GENERIC MARKING DIAGRAM\*



- XXXX = Specific Device Code
- A = Assembly Location
- WL = Wafer Lot
- YY = Year
- WW = Work Week
- G = Pb-Free Package

\*This information is generic. Please refer to device data sheet for actual part marking. Pb-Free indicator, "G" or microdot "▪", may or may not be present.

- STYLE 1:  
PIN 1. AC IN  
2. DC + IN  
3. DC - IN  
4. AC IN  
5. GROUND  
6. OUTPUT  
7. AUXILIARY  
8. V<sub>CC</sub>

DOCUMENT NUMBER:	98ASB42420B	Electronic versions are uncontrolled except when accessed directly from the Document Repository. Printed versions are uncontrolled except when stamped "CONTROLLED COPY" in red.
DESCRIPTION:	PDIP-8	PAGE 1 OF 1

ON Semiconductor and are trademarks of Semiconductor Components Industries, LLC dba ON Semiconductor or its subsidiaries in the United States and/or other countries. ON Semiconductor reserves the right to make changes without further notice to any products herein. ON Semiconductor makes no warranty, representation or guarantee regarding the suitability of its products for any particular purpose, nor does ON Semiconductor assume any liability arising out of the application or use of any product or circuit, and specifically disclaims any and all liability, including without limitation special, consequential or incidental damages. ON Semiconductor does not convey any license under its patent rights nor the rights of others.

# MECHANICAL CASE OUTLINE PACKAGE DIMENSIONS



SCALE 1:1

SOIC-8 NB  
CASE 751-07  
ISSUE AK

DATE 16 FEB 2011



- NOTES:
1. DIMENSIONING AND TOLERANCING PER ANSI Y14.5M, 1982.
  2. CONTROLLING DIMENSION: MILLIMETER.
  3. DIMENSION A AND B DO NOT INCLUDE MOLD PROTRUSION.
  4. MAXIMUM MOLD PROTRUSION 0.15 (0.006) PER SIDE.
  5. DIMENSION D DOES NOT INCLUDE DAMBAR PROTRUSION. ALLOWABLE DAMBAR PROTRUSION SHALL BE 0.127 (0.005) TOTAL IN EXCESS OF THE D DIMENSION AT MAXIMUM MATERIAL CONDITION.
  6. 751-01 THRU 751-06 ARE OBSOLETE. NEW STANDARD IS 751-07.

DIM	MILLIMETERS		INCHES	
	MIN	MAX	MIN	MAX
A	4.80	5.00	0.189	0.197
B	3.80	4.00	0.150	0.157
C	1.35	1.75	0.053	0.069
D	0.33	0.51	0.013	0.020
G	1.27 BSC		0.050 BSC	
H	0.10	0.25	0.004	0.010
J	0.19	0.25	0.007	0.010
K	0.40	1.27	0.016	0.050
M	0°	8°	0°	8°
N	0.25	0.50	0.010	0.020
S	5.80	6.20	0.228	0.244

## GENERIC MARKING DIAGRAM\*

### SOLDERING FOOTPRINT\*



XXXXX = Specific Device Code  
A = Assembly Location  
L = Wafer Lot  
Y = Year  
W = Work Week  
▪ = Pb-Free Package

XXXXXX = Specific Device Code  
A = Assembly Location  
Y = Year  
WW = Work Week  
▪ = Pb-Free Package

\*This information is generic. Please refer to device data sheet for actual part marking. Pb-Free indicator, "G" or microdot "▪", may or may not be present. Some products may not follow the Generic Marking.

\*For additional information on our Pb-Free strategy and soldering details, please download the ON Semiconductor Soldering and Mounting Techniques Reference Manual, SOLDERRM/D.

## STYLES ON PAGE 2

DOCUMENT NUMBER:	98ASB42564B	Electronic versions are uncontrolled except when accessed directly from the Document Repository. Printed versions are uncontrolled except when stamped "CONTROLLED COPY" in red.
DESCRIPTION:	SOIC-8 NB	PAGE 1 OF 2

onsemi and ONSEMI are trademarks of Semiconductor Components Industries, LLC dba onsemi or its subsidiaries in the United States and/or other countries. onsemi reserves the right to make changes without further notice to any products herein. onsemi makes no warranty, representation or guarantee regarding the suitability of its products for any particular purpose, nor does onsemi assume any liability arising out of the application or use of any product or circuit, and specifically disclaims any and all liability, including without limitation special, consequential or incidental damages. onsemi does not convey any license under its patent rights nor the rights of others.

**SOIC-8 NB**  
**CASE 751-07**  
**ISSUE AK**

DATE 16 FEB 2011

- |   |  |  |  |
|---|--|--|--|
| <p>STYLE 1:<br/>         PIN 1. EMITTER<br/>         2. COLLECTOR<br/>         3. COLLECTOR<br/>         4. EMITTER<br/>         5. EMITTER<br/>         6. BASE<br/>         7. BASE<br/>         8. EMITTER</p>   | <p>STYLE 2:<br/>         PIN 1. COLLECTOR, DIE, #1<br/>         2. COLLECTOR, #1<br/>         3. COLLECTOR, #2<br/>         4. COLLECTOR, #2<br/>         5. BASE, #2<br/>         6. EMITTER, #2<br/>         7. BASE, #1<br/>         8. EMITTER, #1</p>               | <p>STYLE 3:<br/>         PIN 1. DRAIN, DIE #1<br/>         2. DRAIN, #1<br/>         3. DRAIN, #2<br/>         4. DRAIN, #2<br/>         5. GATE, #2<br/>         6. SOURCE, #2<br/>         7. GATE, #1<br/>         8. SOURCE, #1</p>                            | <p>STYLE 4:<br/>         PIN 1. ANODE<br/>         2. ANODE<br/>         3. ANODE<br/>         4. ANODE<br/>         5. ANODE<br/>         6. ANODE<br/>         7. ANODE<br/>         8. COMMON CATHODE</p>   |
| <p>STYLE 5:<br/>         PIN 1. DRAIN<br/>         2. DRAIN<br/>         3. DRAIN<br/>         4. DRAIN<br/>         5. GATE<br/>         6. GATE<br/>         7. SOURCE<br/>         8. SOURCE</p>   | <p>STYLE 6:<br/>         PIN 1. SOURCE<br/>         2. DRAIN<br/>         3. DRAIN<br/>         4. SOURCE<br/>         5. SOURCE<br/>         6. GATE<br/>         7. GATE<br/>         8. SOURCE</p>  | <p>STYLE 7:<br/>         PIN 1. INPUT<br/>         2. EXTERNAL BYPASS<br/>         3. THIRD STAGE SOURCE<br/>         4. GROUND<br/>         5. DRAIN<br/>         6. GATE 3<br/>         7. SECOND STAGE Vd<br/>         8. FIRST STAGE Vd</p>                    | <p>STYLE 8:<br/>         PIN 1. COLLECTOR, DIE #1<br/>         2. BASE, #1<br/>         3. BASE, #2<br/>         4. COLLECTOR, #2<br/>         5. COLLECTOR, #2<br/>         6. EMITTER, #2<br/>         7. EMITTER, #1<br/>         8. COLLECTOR, #1</p>                              |
| <p>STYLE 9:<br/>         PIN 1. EMITTER, COMMON<br/>         2. COLLECTOR, DIE #1<br/>         3. COLLECTOR, DIE #2<br/>         4. EMITTER, COMMON<br/>         5. EMITTER, COMMON<br/>         6. BASE, DIE #2<br/>         7. BASE, DIE #1<br/>         8. EMITTER, COMMON</p> | <p>STYLE 10:<br/>         PIN 1. GROUND<br/>         2. BIAS 1<br/>         3. OUTPUT<br/>         4. GROUND<br/>         5. GROUND<br/>         6. BIAS 2<br/>         7. INPUT<br/>         8. GROUND</p>  | <p>STYLE 11:<br/>         PIN 1. SOURCE 1<br/>         2. GATE 1<br/>         3. SOURCE 2<br/>         4. GATE 2<br/>         5. DRAIN 2<br/>         6. DRAIN 2<br/>         7. DRAIN 1<br/>         8. DRAIN 1</p>   | <p>STYLE 12:<br/>         PIN 1. SOURCE<br/>         2. SOURCE<br/>         3. SOURCE<br/>         4. GATE<br/>         5. DRAIN<br/>         6. DRAIN<br/>         7. DRAIN<br/>         8. DRAIN</p>   |
| <p>STYLE 13:<br/>         PIN 1. N.C.<br/>         2. SOURCE<br/>         3. SOURCE<br/>         4. GATE<br/>         5. DRAIN<br/>         6. DRAIN<br/>         7. DRAIN<br/>         8. DRAIN</p>  | <p>STYLE 14:<br/>         PIN 1. N-SOURCE<br/>         2. N-GATE<br/>         3. P-SOURCE<br/>         4. P-GATE<br/>         5. P-DRAIN<br/>         6. P-DRAIN<br/>         7. N-DRAIN<br/>         8. N-DRAIN</p>   | <p>STYLE 15:<br/>         PIN 1. ANODE 1<br/>         2. ANODE 1<br/>         3. ANODE 1<br/>         4. ANODE 1<br/>         5. CATHODE, COMMON<br/>         6. CATHODE, COMMON<br/>         7. CATHODE, COMMON<br/>         8. CATHODE, COMMON</p>               | <p>STYLE 16:<br/>         PIN 1. EMITTER, DIE #1<br/>         2. BASE, DIE #1<br/>         3. EMITTER, DIE #2<br/>         4. BASE, DIE #2<br/>         5. COLLECTOR, DIE #2<br/>         6. COLLECTOR, DIE #2<br/>         7. COLLECTOR, DIE #1<br/>         8. COLLECTOR, DIE #1</p> |
| <p>STYLE 17:<br/>         PIN 1. VCC<br/>         2. V2OUT<br/>         3. V1OUT<br/>         4. TXE<br/>         5. RXE<br/>         6. VEE<br/>         7. GND<br/>         8. ACC</p>  | <p>STYLE 18:<br/>         PIN 1. ANODE<br/>         2. ANODE<br/>         3. SOURCE<br/>         4. GATE<br/>         5. DRAIN<br/>         6. DRAIN<br/>         7. CATHODE<br/>         8. CATHODE</p>   | <p>STYLE 19:<br/>         PIN 1. SOURCE 1<br/>         2. GATE 1<br/>         3. SOURCE 2<br/>         4. GATE 2<br/>         5. DRAIN 2<br/>         6. MIRROR 2<br/>         7. DRAIN 1<br/>         8. MIRROR 1</p>   | <p>STYLE 20:<br/>         PIN 1. SOURCE (N)<br/>         2. GATE (N)<br/>         3. SOURCE (P)<br/>         4. GATE (P)<br/>         5. DRAIN<br/>         6. DRAIN<br/>         7. DRAIN<br/>         8. DRAIN</p>   |
| <p>STYLE 21:<br/>         PIN 1. CATHODE 1<br/>         2. CATHODE 2<br/>         3. CATHODE 3<br/>         4. CATHODE 4<br/>         5. CATHODE 5<br/>         6. COMMON ANODE<br/>         7. COMMON ANODE<br/>         8. CATHODE 6</p>  | <p>STYLE 22:<br/>         PIN 1. I/O LINE 1<br/>         2. COMMON CATHODE/VCC<br/>         3. COMMON CATHODE/VCC<br/>         4. I/O LINE 3<br/>         5. COMMON ANODE/GND<br/>         6. I/O LINE 4<br/>         7. I/O LINE 5<br/>         8. COMMON ANODE/GND</p> | <p>STYLE 23:<br/>         PIN 1. LINE 1 IN<br/>         2. COMMON ANODE/GND<br/>         3. COMMON ANODE/GND<br/>         4. LINE 2 IN<br/>         5. LINE 2 OUT<br/>         6. COMMON ANODE/GND<br/>         7. COMMON ANODE/GND<br/>         8. LINE 1 OUT</p> | <p>STYLE 24:<br/>         PIN 1. BASE<br/>         2. EMITTER<br/>         3. COLLECTOR/ANODE<br/>         4. COLLECTOR/ANODE<br/>         5. CATHODE<br/>         6. CATHODE<br/>         7. COLLECTOR/ANODE<br/>         8. COLLECTOR/ANODE</p>                                      |
| <p>STYLE 25:<br/>         PIN 1. VIN<br/>         2. N/C<br/>         3. REXT<br/>         4. GND<br/>         5. IOUT<br/>         6. IOUT<br/>         7. IOUT<br/>         8. IOUT</p>   | <p>STYLE 26:<br/>         PIN 1. GND<br/>         2. dv/dt<br/>         3. ENABLE<br/>         4. ILIMIT<br/>         5. SOURCE<br/>         6. SOURCE<br/>         7. SOURCE<br/>         8. VCC</p>  | <p>STYLE 27:<br/>         PIN 1. ILIMIT<br/>         2. OVLO<br/>         3. UVLO<br/>         4. INPUT+<br/>         5. SOURCE<br/>         6. SOURCE<br/>         7. SOURCE<br/>         8. DRAIN</p>  | <p>STYLE 28:<br/>         PIN 1. SW_TO_GND<br/>         2. DASIC_OFF<br/>         3. DASIC_SW_DET<br/>         4. GND<br/>         5. V_MON<br/>         6. VBULK<br/>         7. VBULK<br/>         8. VIN</p>  |
| <p>STYLE 29:<br/>         PIN 1. BASE, DIE #1<br/>         2. EMITTER, #1<br/>         3. BASE, #2<br/>         4. EMITTER, #2<br/>         5. COLLECTOR, #2<br/>         6. COLLECTOR, #2<br/>         7. COLLECTOR, #1<br/>         8. COLLECTOR, #1</p>                        | <p>STYLE 30:<br/>         PIN 1. DRAIN 1<br/>         2. DRAIN 1<br/>         3. GATE 2<br/>         4. SOURCE 2<br/>         5. SOURCE 1/DRAIN 2<br/>         6. SOURCE 1/DRAIN 2<br/>         7. SOURCE 1/DRAIN 2<br/>         8. GATE 1</p>                           |  |  |

<b>DOCUMENT NUMBER:</b>	<b>98ASB42564B</b>	Electronic versions are uncontrolled except when accessed directly from the Document Repository. Printed versions are uncontrolled except when stamped "CONTROLLED COPY" in red.
<b>DESCRIPTION:</b>	<b>SOIC-8 NB</b>	<b>PAGE 2 OF 2</b>

**onsemi** and **ONSEMI** are trademarks of Semiconductor Components Industries, LLC dba **onsemi** or its subsidiaries in the United States and/or other countries. **onsemi** reserves the right to make changes without further notice to any products herein. **onsemi** makes no warranty, representation or guarantee regarding the suitability of its products for any particular purpose, nor does **onsemi** assume any liability arising out of the application or use of any product or circuit, and specifically disclaims any and all liability, including without limitation special, consequential or incidental damages. **onsemi** does not convey any license under its patent rights nor the rights of others.

**onsemi**, **Onsemi**, and other names, marks, and brands are registered and/or common law trademarks of Semiconductor Components Industries, LLC dba "**onsemi**" or its affiliates and/or subsidiaries in the United States and/or other countries. **onsemi** owns the rights to a number of patents, trademarks, copyrights, trade secrets, and other intellectual property. A listing of **onsemi**'s product/patent coverage may be accessed at [www.onsemi.com/site/pdf/Patent-Marking.pdf](http://www.onsemi.com/site/pdf/Patent-Marking.pdf). **onsemi** reserves the right to make changes at any time to any products or information herein, without notice. The information herein is provided "as-is" and **onsemi** makes no warranty, representation or guarantee regarding the accuracy of the information, product features, availability, functionality, or suitability of its products for any particular purpose, nor does **onsemi** assume any liability arising out of the application or use of any product or circuit, and specifically disclaims any and all liability, including without limitation special, consequential or incidental damages. Buyer is responsible for its products and applications using **onsemi** products, including compliance with all laws, regulations and safety requirements or standards, regardless of any support or applications information provided by **onsemi**. "Typical" parameters which may be provided in **onsemi** data sheets and/or specifications can and do vary in different applications and actual performance may vary over time. All operating parameters, including "Typicals" must be validated for each customer application by customer's technical experts. **onsemi** does not convey any license under any of its intellectual property rights nor the rights of others. **onsemi** products are not designed, intended, or authorized for use as a critical component in life support systems or any FDA Class 3 medical devices or medical devices with a same or similar classification in a foreign jurisdiction or any devices intended for implantation in the human body. Should Buyer purchase or use **onsemi** products for any such unintended or unauthorized application, Buyer shall indemnify and hold **onsemi** and its officers, employees, subsidiaries, affiliates, and distributors harmless against all claims, costs, damages, and expenses, and reasonable attorney fees arising out of, directly or indirectly, any claim of personal injury or death associated with such unintended or unauthorized use, even if such claim alleges that **onsemi** was negligent regarding the design or manufacture of the part. **onsemi** is an Equal Opportunity/Affirmative Action Employer. This literature is subject to all applicable copyright laws and is not for resale in any manner.

## PUBLICATION ORDERING INFORMATION

### LITERATURE FULFILLMENT:

Email Requests to: [orderlit@onsemi.com](mailto:orderlit@onsemi.com)

**onsemi Website:** [www.onsemi.com](http://www.onsemi.com)

### TECHNICAL SUPPORT

**North American Technical Support:**

Voice Mail: 1 800-282-9855 Toll Free USA/Canada

Phone: 011 421 33 790 2910

**Europe, Middle East and Africa Technical Support:**

Phone: 00421 33 790 2910

For additional information, please contact your local Sales Representative

