

PRODUCT NO. 51915-365-- NOTE 3	ROWS D C B A	SIGNAL																				
		E2	19	18	17	16	15	14	13	12	11	10	9	8	7	6	5	4	3	2	1	E1
		M	X	M	X	M	X	M	X	M	X	M	X	M	X	M	X	M	X	M	X	
		L	X	L	X	L	X	L	X	L	X	L	X	L	X	L	X	L	X	L	X	
		J	X	J	X	J	X	J	X	J	X	J	X	J	X	J	X	J	X	J	X	

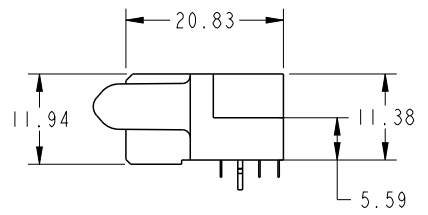

CODE	DIM "M" MATING LENGTH	CONTACT TYPE
M	[N/A]	SIGNAL
L	[N/A]	SIGNAL
K	[N/A]	SIGNAL
J	[N/A]	SIGNAL
HA	[N/A]	HOLD-DOWN
X	OMIITED	OMIITED

spec ref	SEE NOTES			dr	Luo Weller	2012/06/26	projection 	MM ←→	size	A4	scale	1:1	
tolerance std	TOLERANCES UNLESS OTHERWISE SPECIFIED			eng	Luo Weller	2014/11/19			ecn no	ELX-DG-19484-1			
SEE NOTES				chr	-	-			product family	PwrBlade		rel level	Released
surface ✓	linear	0.X	±0.50	FCj www.fci.com	title	76S R/A SOLDER RECEPTACLE	dwg no	51915-365	rev	B			
		0.XX	±0.25										
	angular	0°	±2°								cat. no.	Product - Customer Drw	

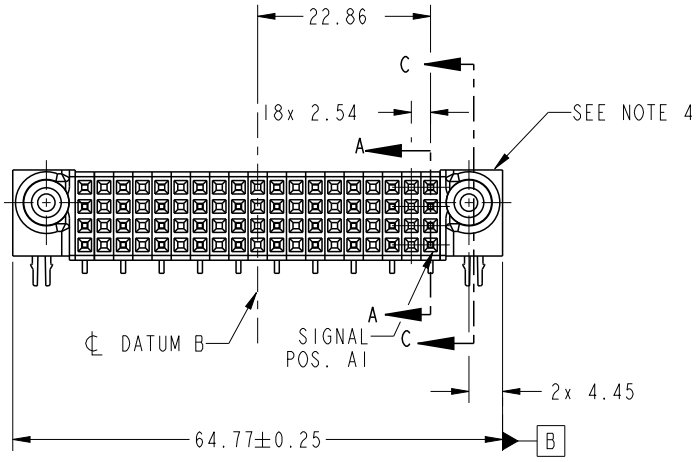

Copyright FCI.

PrntE File - REV C - 2009-06-09

PRODUCT NUMBER

51915-365__
NOTE 3

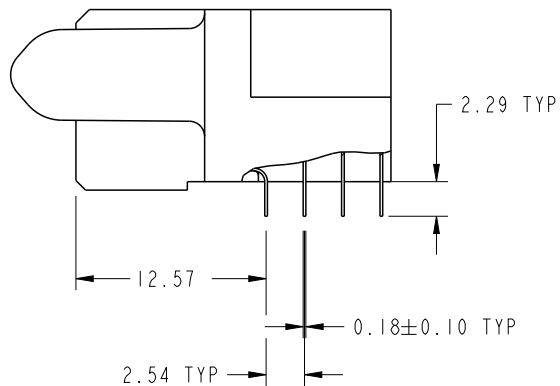

BROKEN-OUT SECTION A-A
SCALE 2:1

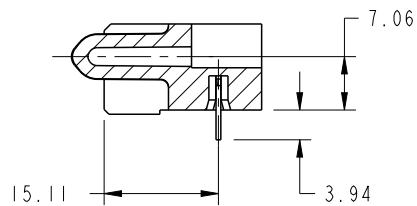

SECTION C-C

dr	Luo Weller	2012/06/26	projection 	MM ←————→	size	A4	scale	1:1	
eng	Luo Weller	2014/11/19			ecn no	ELX-DG-19484-1			
chr	-	-			product family	PwrBlade	rel level	Released	
appr	Pei-Ming Zheng	2014/11/19			title	76S	dwg no	51915-365	
www.fci.com			cat. no.		Product - Customer Drw			rev	B
					sheet 2 of 4				

PRODUCT NUMBER

51915-365__
NOTE 3

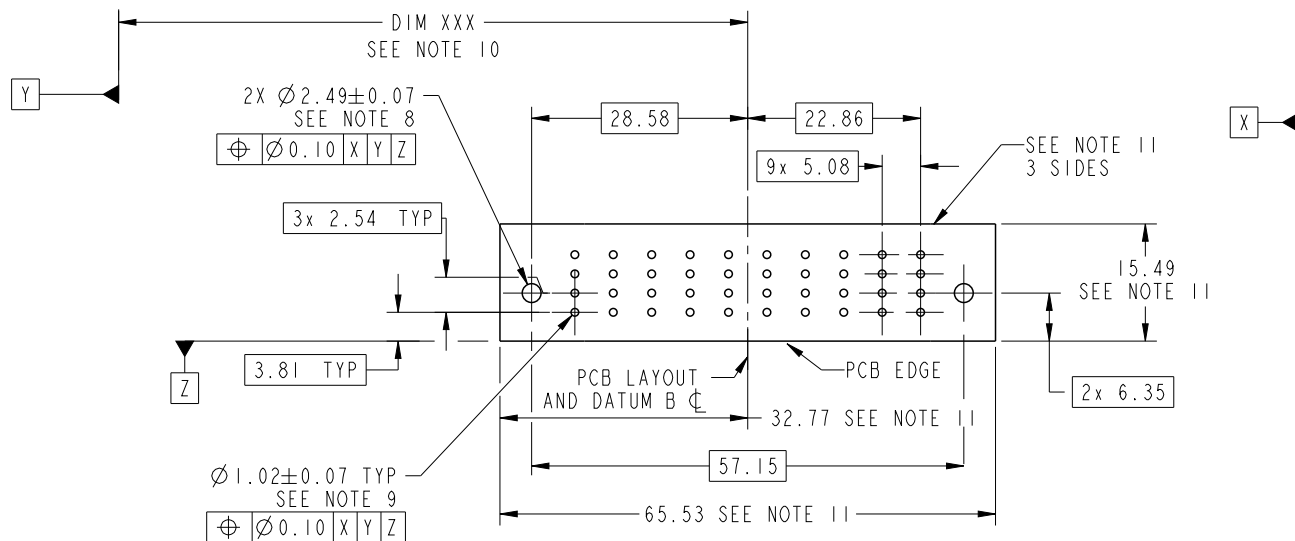

RECOMMENDED PCB LAYOUT

dr	Luo Weller	2012/06/26	projection 	MM 	size	A4	scale	1:1	
eng	Luo Weller	2014/11/19			ecn no	ELX-DG-19484-1			
chr	-	-			rel level	Released			
appr	Pei-Ming Zheng	2014/11/19	product family	PwrBlade					
		title	76S R/A SOLDER RECEPTACLE		dwg no	51915-365		rev	B
www.fci.com		cat. no.	Product - Customer Drw			sheet 3 of 4			

PRODUCT NUMBER

51915-365--
NOTE 3

NOTES:

1. DIMENSIONS AND TOLERANCES ARE IN ACCORDANCE WITH ASME Y14.5M, 1994 UNLESS OTHERWISE SPECIFIED.

CONNECTOR NOTES:

- 2. HOUSING MATERIAL: UL 94 V-0 GLASS FILLED HIGH-TEMP THERMOPLASTIC
POWER CONTACT MATERIAL: COPPER ALLOY
SIGNAL PIN MATERIAL: COPPER ALLOY
- 3. SEE ITEM 5 & 6 IN PRINT 10064183 FOR PLATING SPEC OF 51915-365 AND 51915-365LF RESPECTIVELY.
- 4. MANUFACTURER'S NAME, DATE CODE AND OPTIONAL P/N TO APPEAR ON THIS SURFACE. THE P/N CAN BE OMITTED IF THERE IS NOT ENOUGH SPACE ON THIS SURFACE.
- 5. PRODUCT SPECIFICATION GS-12-149.
APPLICATION SPECIFICATION BUS-20-067.
- 6. PACKAGED IN TRAYS.

PCB NOTES:

- 7. ALL HOLE DIAMETERS ARE FINISHED HOLE SIZE.
- 8. MOUNTING HOLES, WHERE APPLICABLE, ARE UNPLATED.
- 9. $\varnothing 1.151 \pm 0.025$ DRILLED HOLES PLATED WITH
0.008 MIN SnPb OR Sn OVER 0.03
TO 0.08 Cu PLATING TO ACHIEVE
 $\varnothing 1.02 \pm .07$ HOLE.
- 10. "DIM XXX" TO BE DETERMINED BY THE CUSTOMER.
- 11. CONNECTOR KEEP-OUT ZONE.
- 12. THE VOID CORING IN BETWEEN POWER MODULES, SIGNAL MODULES AND END MODULES ARE OPTIONAL AND THE SHAPE MAY BE DIFFERENT FOR OPTIMIZE THE MOLDING PROCESS. THE VOID CORING WILL NOT EFFECT TO PRODUCT FUNCTION.

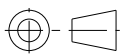
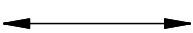
dr	Luo Weller	2012/06/26	projection 	MM 	size	A4	scale	1:1			
eng	Luo Weller	2014/11/19			ecn no	ELX-DG-19484-1					
chr	-	-			product family	PwrBlade	rel level	Released			
appr	Pei-Ming Zheng	2014/11/19	www.fci.com		title	76S R/A SOLDER RECEPTACLE		dwg no	51915-365	rev	B
cat. no.		Product - Customer Drw			sheet 4 of 4						