

Low drop power Schottky rectifier

Features

- Very small conduction losses
- Negligible switching losses
- Extremely fast switching
- Low forward voltage drop
- Low thermal resistance
- High avalanche capability specified

Description

Dual center tap Schottky rectifier suited for switch mode power supply and high frequency DC to DC converters.

Packaged in PowerFLAT™, this device is intended for use in low voltage, high frequency inverters, free-wheeling and polarity protection applications.

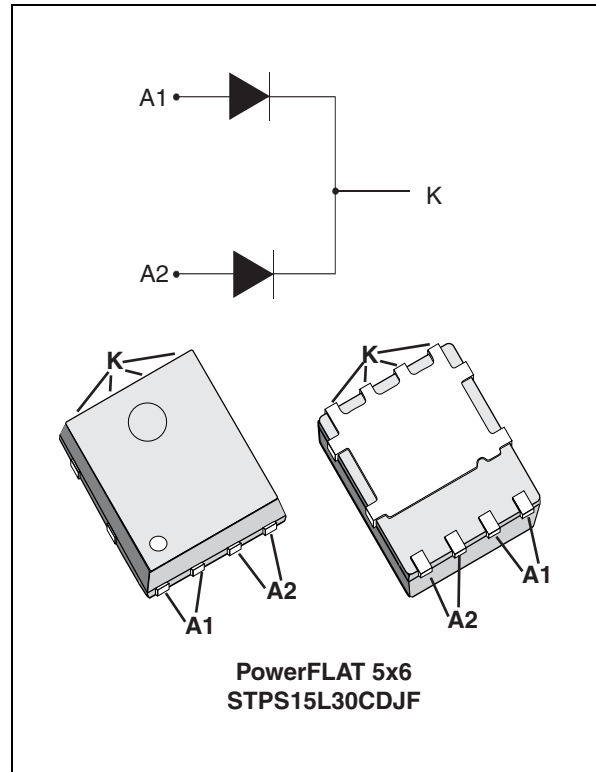

Table 1. Device summary

Symbol	Value
$I_{F(AV)}$	2 x 7.5 A
V_{RRM}	30 V
T_j (max)	150 °C
V_F (typ)	0.34 V

TM: PowerFLAT is a trademark of STMicroelectronics

1 Characteristics

Table 2. Absolute ratings (limiting values, per diode)

Symbol	Parameter		Value	Unit	
V _{RRM}	Repetitive peak reverse voltage		30	V	
I _{F(RMS)}	Forward rms current		10	A	
I _{F(AV)}	Average forward current $\delta = 0.5$	T _c = 140 °C	Per diode	7.5	A
			Per device	15	
I _{FSM}	Surge non repetitive forward current	t _p = 10 ms sinusoidal	75	A	
I _R	Peak repetitive reverse current	t _p = 2 μ s square F= 1 kHz	1	A	
P _{ARM}	Repetitive peak avalanche power	t _p = 1 μ s T _j = 25 °C	2800	W	
T _{stg}	Storage temperature range		-65 to + 175	°C	
T _j	Maximum operating junction temperature ⁽¹⁾		150	°C	

1. $\frac{dP_{tot}}{dT_j} < \frac{1}{R_{th(j-a)}}$ condition to avoid thermal runaway for a diode on its own heatsink

Table 3. Thermal resistance

Symbol	Parameter		Value	Unit
R _{th(j-c)}	Junction to case	Per diode	2.5	°C/W
		Total	1.6	
R _{th(c)}	Coupling		0.7	

When diodes 1 and 2 are used simultaneously:

$$\Delta T_j(\text{diode 1}) = P(\text{diode1}) \times R_{th(j-c)}(\text{per diode}) + P(\text{diode 2}) \times R_{th(c)}$$

Table 4. Static electrical characteristics (per diode)

Symbol	Parameter	Test conditions		Min.	Typ.	Max.	Unit
I _R ⁽¹⁾	Reverse leakage current	T _j = 25 °C	V _R = V _{RRM}	-	-	1	mA
		T _j = 125 °C		-	70	140	mA
V _F ⁽¹⁾	Forward voltage drop	T _j = 25 °C	I _F = 7.5 A	-	-	0.48	V
		T _j = 125 °C	I _F = 7.5 A	-	0.34	0.39	
		T _j = 25 °C	I _F = 15 A	-	-	0.57	
		T _j = 125 °C	I _F = 15 A	-	0.44	0.51	

1. Pulse test: t_p = 380 μ s, $\delta < 2\%$

To evaluate the conduction losses use the following equation:

$$P = 0.27 \times I_{F(AV)} + 0.016 I_{F(RMS)}^2$$

Figure 1. Average forward power dissipation versus average forward current (per diode)

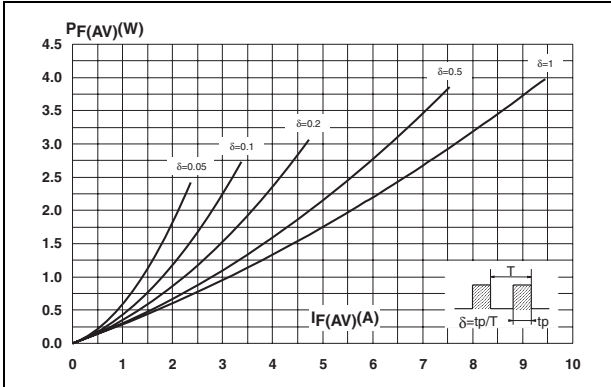

Figure 2. Average forward current versus ambient temperature ($\delta = 0.5$, per diode)

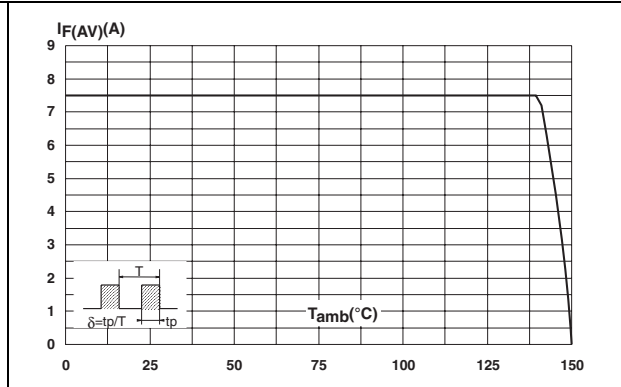

Figure 3. Normalized avalanche power derating versus pulse duration

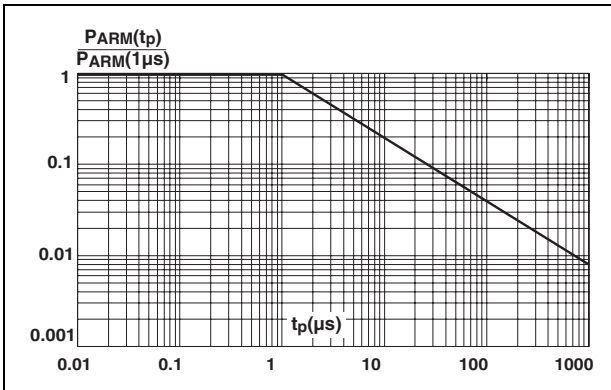

Figure 4. Normalized avalanche power derating versus junction temperature

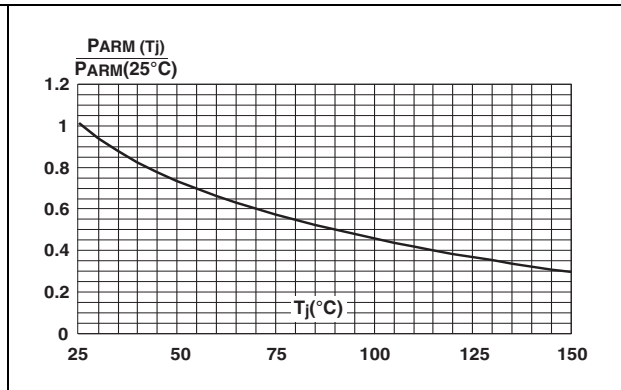

Figure 5. Non repetitive surge peak forward current versus overload duration (maximum values, per diode)

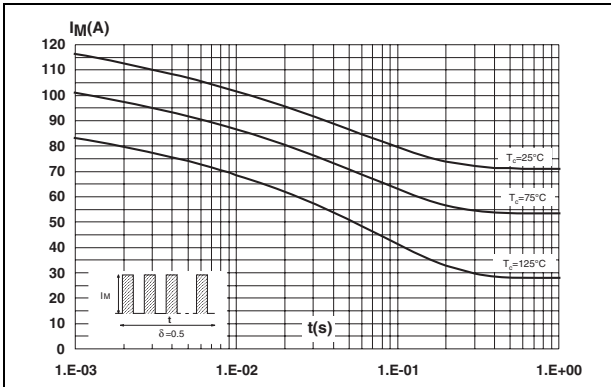

Figure 6. Relative variation of thermal impedance, junction to case, versus pulse duration

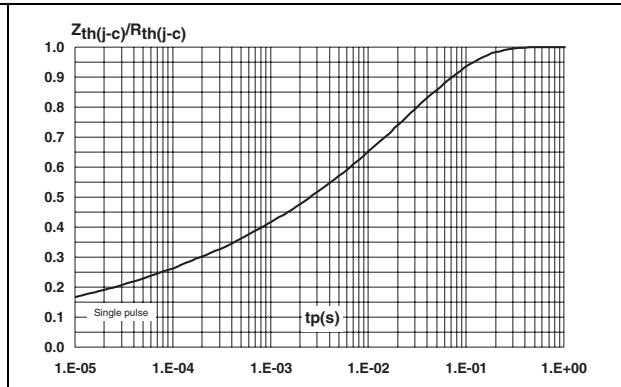

Figure 7. Reverse leakage current versus reverse voltage applied (typical values, per diode)

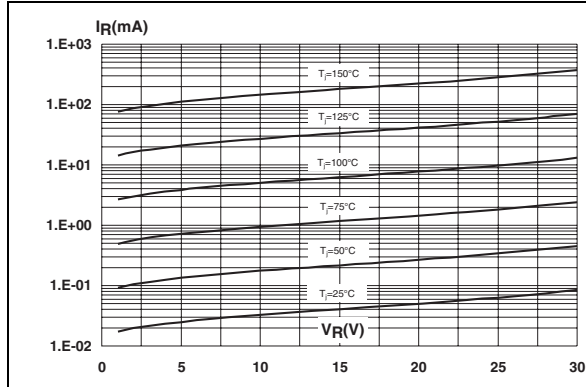

Figure 8. Junction capacitance versus reverse voltage applied (typical values, per diode)

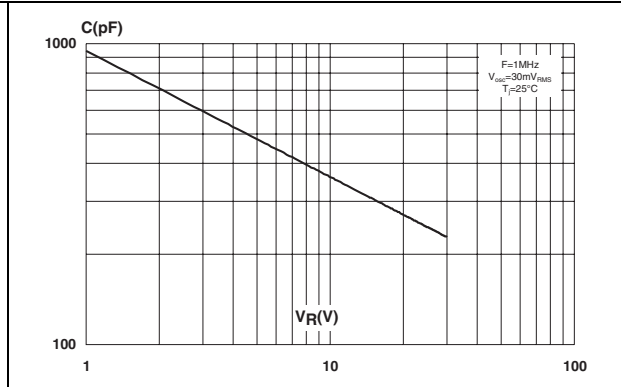

Figure 9. Forward voltage drop versus forward current (per diode)

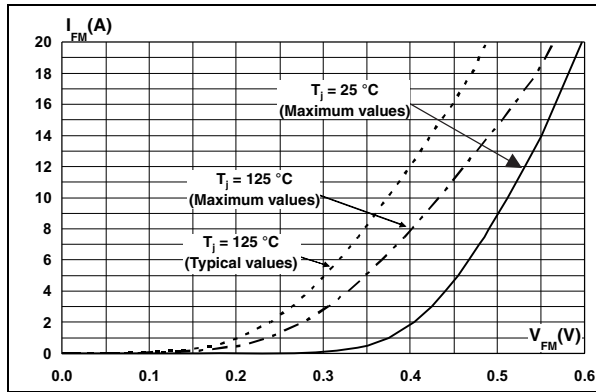
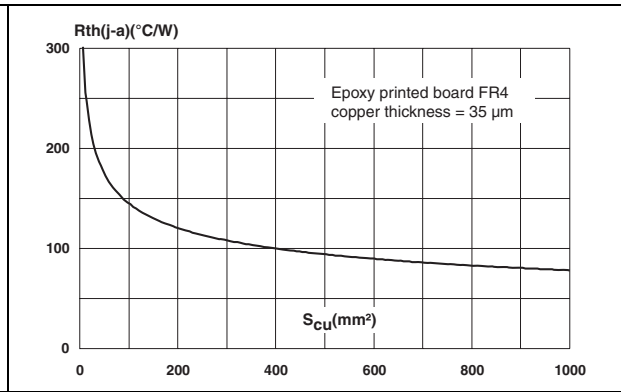

Figure 10. Thermal resistance junction to ambient versus copper surface under each lead



2 Package information

- Epoxy meets UL94,V0
- Lead-free package

In order to meet environmental requirements, ST offers these devices in different grades of ECOPACK® packages, depending on their level of environmental compliance. ECOPACK® specifications, grade definitions and product status are available at: www.st.com. ECOPACK® is an ST trademark.

Table 5. PowerFLAT 5x6 dimensions

Ref.	Dimensions					
	Millimeters			Inches		
	Min.	Typ.	Max.	Min.	Typ.	Max.
A	0.80		1.00	0.031		0.039
A1	0.02		0.05	0.001		0.002
A2		0.25			0.010	
b	0.30		0.50	0.012		0.020
D		5.20			0.205	
D2	4.11		4.31	0.162		0.170
e		1.27			0.050	
E		6.15			0.242	
E2	3.50		3.70	0.138		0.146
L	0.50		0.80	0.020		0.031
K	1.275		1.575	0.050		0.062

Figure 11. Footprint (dimensions in mm)

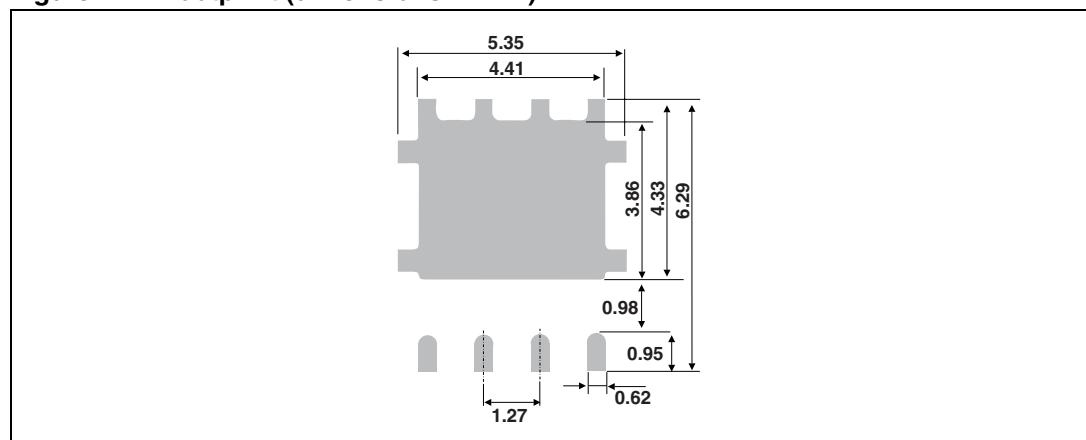
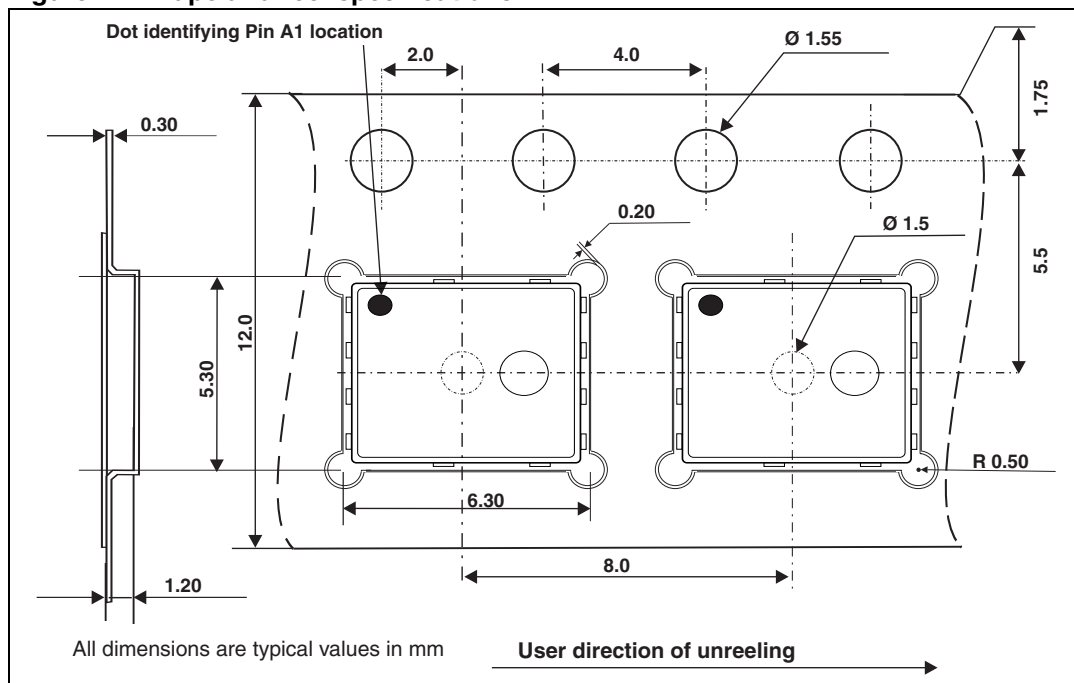

Figure 12. Tape and reel specifications



3 Ordering information

Table 6. Ordering information

Order code	Marking	Package	Weight	Base qty	Delivery mode
STPS15L30CDJFTR	PS15 L30C	PowerFLAT 5x6	0.095 g	3000	Tape and reel

4 Revision history

Table 7. Document revision history

Date	Revision	Changes
13-May-2009	1	First issue.
09-Nov-2009	2	Updated Table 1 .
30-Jul-2010	3	Replace Power QFN with PowerFLAT. Updated Figure 9 .
18-May-2011	4	Added reference E in Table 5 . Updated package graphics. Removed dash from order code and updated marking in Table 6 . Added Figure 12 .

Please Read Carefully:

Information in this document is provided solely in connection with ST products. STMicroelectronics NV and its subsidiaries ("ST") reserve the right to make changes, corrections, modifications or improvements, to this document, and the products and services described herein at any time, without notice.

All ST products are sold pursuant to ST's terms and conditions of sale.

Purchasers are solely responsible for the choice, selection and use of the ST products and services described herein, and ST assumes no liability whatsoever relating to the choice, selection or use of the ST products and services described herein.

No license, express or implied, by estoppel or otherwise, to any intellectual property rights is granted under this document. If any part of this document refers to any third party products or services it shall not be deemed a license grant by ST for the use of such third party products or services, or any intellectual property contained therein or considered as a warranty covering the use in any manner whatsoever of such third party products or services or any intellectual property contained therein.

UNLESS OTHERWISE SET FORTH IN ST'S TERMS AND CONDITIONS OF SALE ST DISCLAIMS ANY EXPRESS OR IMPLIED WARRANTY WITH RESPECT TO THE USE AND/OR SALE OF ST PRODUCTS INCLUDING WITHOUT LIMITATION IMPLIED WARRANTIES OF MERCHANTABILITY, FITNESS FOR A PARTICULAR PURPOSE (AND THEIR EQUIVALENTS UNDER THE LAWS OF ANY JURISDICTION), OR INFRINGEMENT OF ANY PATENT, COPYRIGHT OR OTHER INTELLECTUAL PROPERTY RIGHT.

UNLESS EXPRESSLY APPROVED IN WRITING BY AN AUTHORIZED ST REPRESENTATIVE, ST PRODUCTS ARE NOT RECOMMENDED, AUTHORIZED OR WARRANTED FOR USE IN MILITARY, AIR CRAFT, SPACE, LIFE SAVING, OR LIFE SUSTAINING APPLICATIONS, NOR IN PRODUCTS OR SYSTEMS WHERE FAILURE OR MALFUNCTION MAY RESULT IN PERSONAL INJURY, DEATH, OR SEVERE PROPERTY OR ENVIRONMENTAL DAMAGE. ST PRODUCTS WHICH ARE NOT SPECIFIED AS "AUTOMOTIVE GRADE" MAY ONLY BE USED IN AUTOMOTIVE APPLICATIONS AT USER'S OWN RISK.

Resale of ST products with provisions different from the statements and/or technical features set forth in this document shall immediately void any warranty granted by ST for the ST product or service described herein and shall not create or extend in any manner whatsoever, any liability of ST.

ST and the ST logo are trademarks or registered trademarks of ST in various countries.

Information in this document supersedes and replaces all information previously supplied.

The ST logo is a registered trademark of STMicroelectronics. All other names are the property of their respective owners.

© 2011 STMicroelectronics - All rights reserved

STMicroelectronics group of companies

Australia - Belgium - Brazil - Canada - China - Czech Republic - Finland - France - Germany - Hong Kong - India - Israel - Italy - Japan - Malaysia - Malta - Morocco - Philippines - Singapore - Spain - Sweden - Switzerland - United Kingdom - United States of America

www.st.com

