

HELLO[®]...

鸿志：“您好！”



目录 CATALOG

公司概况 Company Profile	02
公司发展历程 Company Developing Process	03
销售额及合作伙伴 Sales Quota and Partners	05
荣誉资质 Honor	07
电表专用压敏电阻 Special Varistor for Electric Meter	08
通用压敏电阻 General Varistor	09
订货型号说明 How to Order	10
5D系列HEL 通用压敏电阻 HEL General Varistor Series with 5mm Diameter	11
7D系列HEL 通用压敏电阻 HEL General Varistor Series with 7mm Diameter	13
10D系列HEL 通用压敏电阻 HEL General Varistor Series with 10mm Diameter	15
14D系列HEL 通用压敏电阻 HEL General Varistor Series with 14mm Diameter	17
20D系列HEL 通用压敏电阻 HEL General Varistor Series with 20mm Diameter	19
高能压敏电阻 High Energy Varistor	21
25D系列HEL 高能压敏电阻 HEL High Energy Varistor Series with 25mm Diameter	22
32D系列HEL 高能压敏电阻 HEL High Energy Varistor Series with 32mm Diameter	23
40D系列HEL 高能压敏电阻 HEL High Energy Varistor Series with 40mm Diameter	24
53D系列HEL 高能压敏电阻 HEL High Energy Varistor Series with 53mm Diameter	25
34S系列HEL 方形高能压敏电阻 HEL High Energy Varistor with 34mm Square	26
HEL 通用压敏电阻可靠性测试 HEL General Varistor Reliability Testing	27
注意事项 Precautions	33
编带包装 Tape & Reel Packing	39
附录 Appendix	40

企业成员 GROUP

汕头市鸿志电子有限公司

地址: 广东省汕头市龙湖区浦江路6号(电容事业部)

广东省汕头市龙湖区庐山路39号(敏感元件事业部)

Shantou Hong Zhi Electronics Co.,Ltd.

No.6 Pujiang Rd.,Longhu district, Shantou City, Guangdong Province,China

No.39 Lushan Rd.,Longhu district, Shantou City, Guangdong Province,China

TEL: 0754-88831426 (12line) FAX: 0754-88784178 88888417

汕头市鸿志企业有限公司

地址: 汕头市天山路成德工业村C座

Shantou HongZhi Enterprises Ltd.

Build C,Chengde Industrial area, Tianshan Rd.,Shantou

TEL: 0754-88831426 (12line) FAX: 0754-88784178 88888417

香港鸿志电子有限公司

地址: 香港新界葵涌大连排道35-41号金基工业大厦25楼A1室

Hong Zhi Electronics Co.,Ltd.

Flat A1, 25/F., Gold King Industrial Building, 35-41 Tai Lin Pai Rd, Kwai Chung,N.T.,Hong Kong.

揭阳空港经济区弘新电子有限公司

地址: 广东省揭阳空港经济区地都镇蛟龙村蛤坞东侧(金龙工业区)

Hongxin Electronics Co.,Ltd.

Jinlong Industrial area, Jiaolong village Didu town, Jieyang City, China

宁波市舒雷电子有限公司

地址: 浙江省宁波市姜山镇朝阳路37号

Ningbo Shulei Electronics Co.,Ltd.

No.37 Chaoyang Rd., Jiangshan town,NingBo City, Zhejiang province, China.

TEL: 0574-88093028 FAX: 0574-88093026 E-mail: guozhiyongs@163.com

2016版

压敏电阻

VARISTOR



汕头市鸿志电子有限公司

SHANTOU HONGZHI ELECTRONICS CO.,LTD.

地址: 广东省汕头市龙湖区庐山路39号

No.39 Lushan Rd.,Longhu district, Shantou City, Guangdong Province,China

TEL: 0754-88784177

+86-754-88831426-0

FAX: 0754-88888417

+86-754-88888417

Mobile: 13923676782

+86-013923995840

Website: www.varistor.cn

www.hongzhi.net

E-mail: hel@varistor.cn

lnxi@hongzhi.net



汕头市鸿志电子有限公司

SHANTOU HONGZHI ELECTRONICS CO.,LTD.

珍惜资源 · 创造价值
CHERISH RESOURCES & CREATE VALUES

www.varistor.cn
www.hongzhi.net

公司概况
COMPANY PROFILE

鸿志电子有限公司成立于1993年，位于美丽的海滨城市汕头，现已发展成为元器件制造集团企业，生产压敏电阻、NTC热敏电阻、高中低压瓷介电容和金属化薄膜电容，通过了ISO9001质量体系认证和ISO14001环境体系认证。我司是中国电子学会电压敏专业学部主任委员单位，主导产品压敏电阻和电容器生产规模居国内同行前列。公司产品已经获得VDE、UL、CQC、CSA、F1、N、D、S等安规认证。产品被广泛应用在IT、通讯、照明、家电、工业设备等领域。真诚期待与您合作，共同发展!

集团企业成员：

汕头市鸿志电子有限公司

汕头市鸿志企业有限公司

香港鸿志电子有限公司

揭阳空港经济区弘新电子有限公司

宁波市舒雷电子有限公司

HongZhi Electronics Co., Ltd. locating in a coastal city named Shantou since 1993, has been specializing in manufacturing Varistor, NTC Thermistor, Ceramic capacitor, Y type capacitor (Safety Standard recognized ceramic capacitor), Metallized film capacitor. Our company passed the ISO9001 Quality certificate and ISO14001 Environment Certificate. As a director unit of Varistor division in charge of the China Varistor Technology Commission, we develop into a main manufacturer of varistor and capacitor, and our products have been approved by VDE, UL, CQC, CSA, F1, N, D, S Safety Certification, they have been widely used in IT, communication, lighting, home appliances, industrial equipment and other fields. Now most of the products are exporting to America, Europe, Asia, Africa etc. Sincerely look forward to establishing a win-win cooperation with you!

Group :

Shantou HongZhi Electronics Co.,Ltd.

Shantou HongZhi Enterprises Ltd.

Hong Zhi Electronics Co.,Ltd.

Jieyang Hongxin Electronics Co.,Ltd.

Ningbo Shulei Electronics Co.,Ltd.

企业发展历程

COMPANY DEVELOPING PROCESS

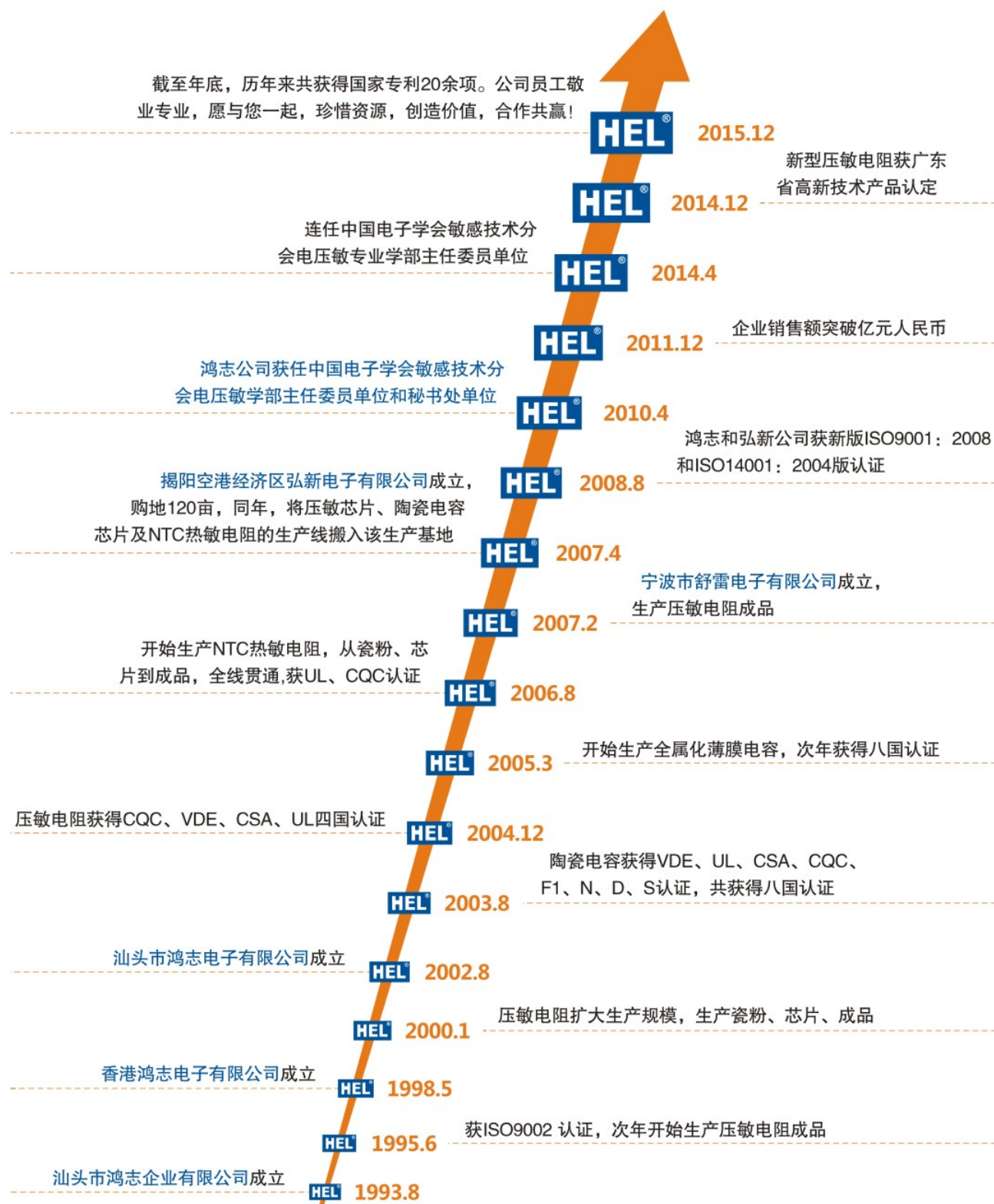

中国电子学会传感技术分会

电压敏学部主任委员单位

A director unit of varistor division,
Sensor technology branch of the Chinese institute of electronics

产品展示 Product display



通用压敏电阻
General Varistor



高能压敏电阻
High Energy Varistor



异形压敏电阻
Special Structure Varistor



压敏电阻芯片
Varistor Chip

生产一线 Workshop



车间一角 A corner of workshop



车间一角 A corner of workshop

资质认证 Quality Certification



ISO9001



File NO.CQC04001010848
China中国CCC认证



File NO.E324904
U.S.A美国UL认证



ISO14001



File NO.215101
Canada加拿大CSA认证



File NO.40037512
Germany德国VDE认证

2015各产品销售额占比

SALES RATIO OF EACH PRODUCT SERIES IN 2015

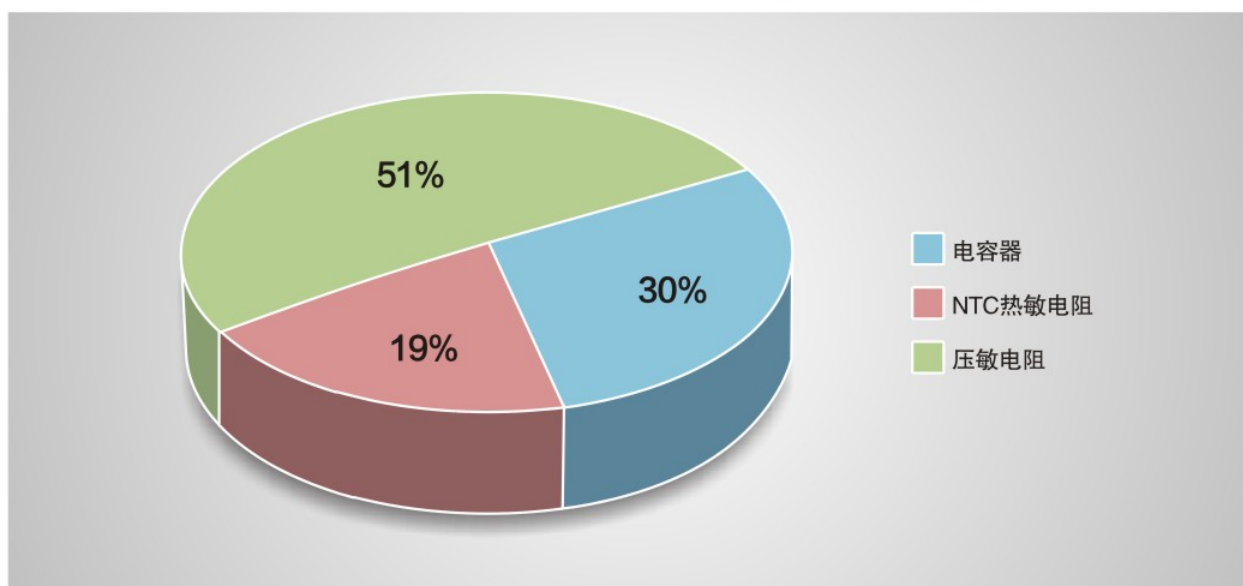

外销合作伙伴区域

EXPORT AREA

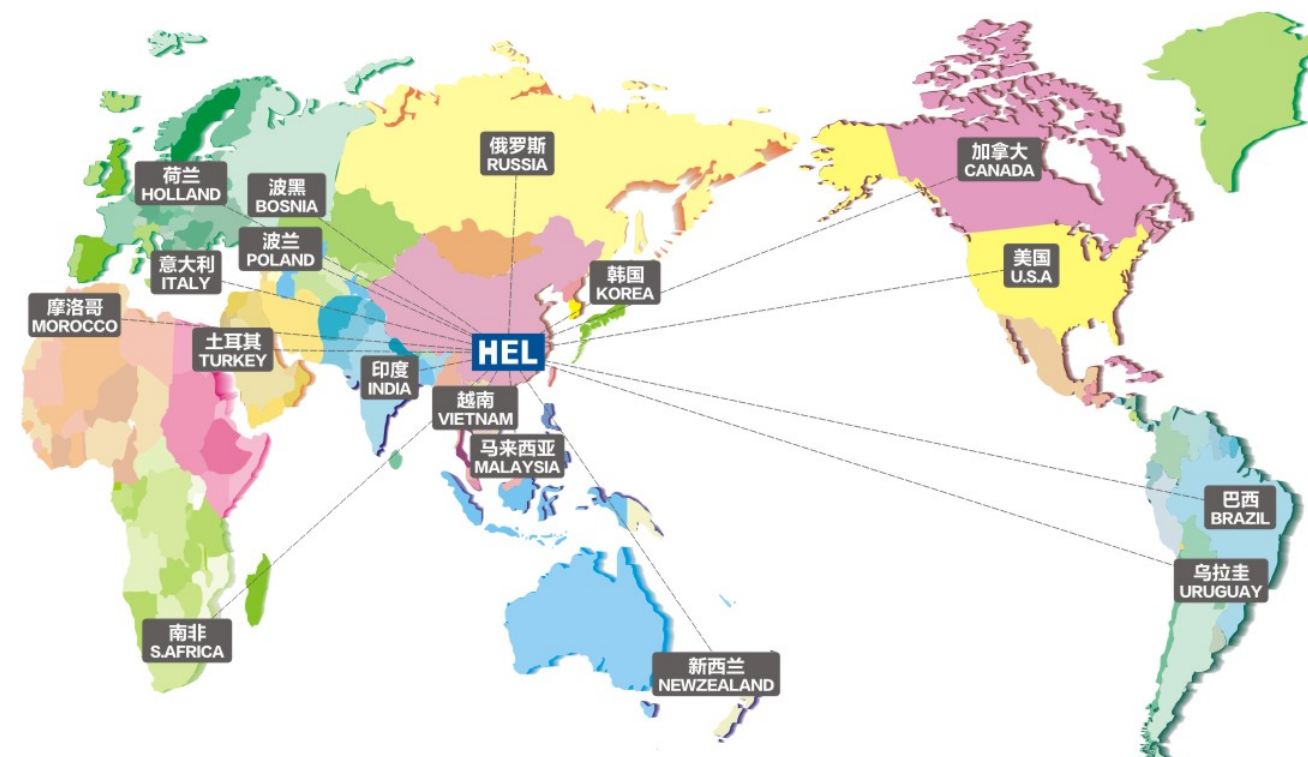

各年度销售额

EACH ANNUAL SALES QUOTA

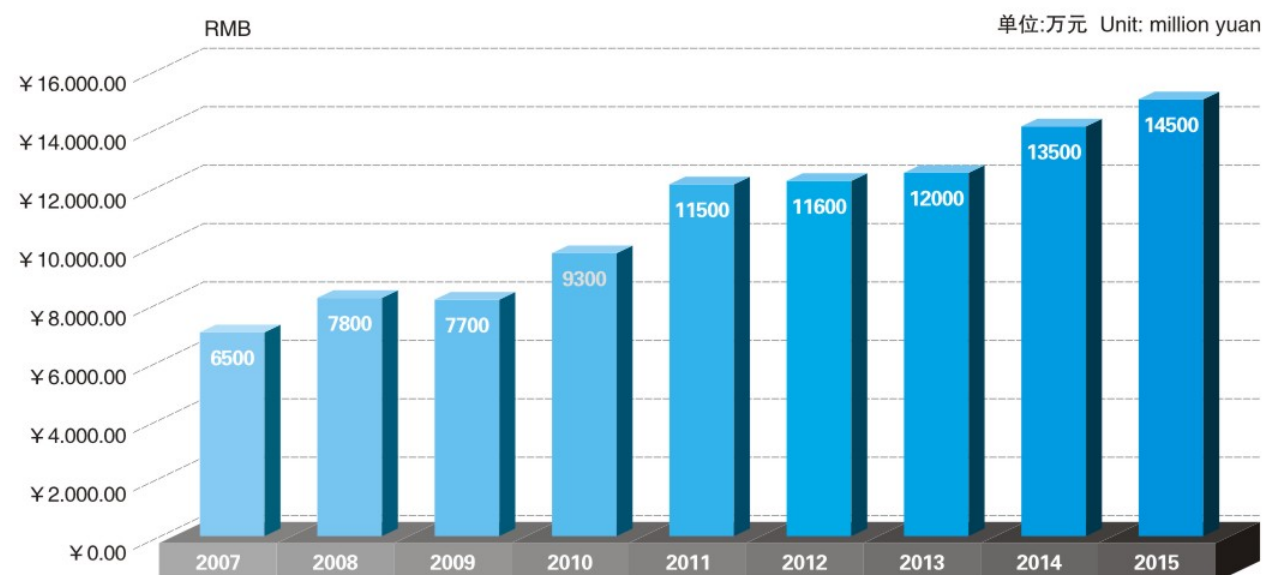

国内合作伙伴

DOMESTIC PARTNERS



安规与体系认证 SAFETY AND SYSTEM CERTIFICATION



专利证书 LETTERS PATENT



电表专用压敏电阻

SPECIAL VARISTOR FOR ELECTRIC METER

产品标识代码 PRODUCT IDENTIFICATION CODE

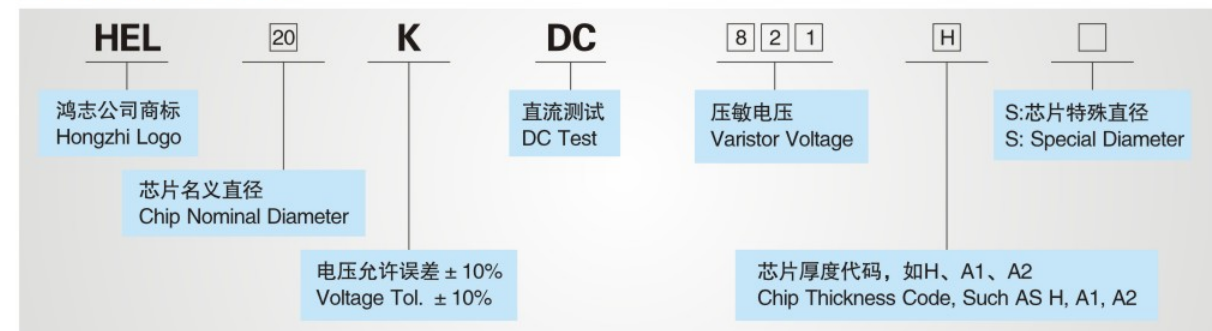

20KA 专用压敏电阻

20KA SPECIAL VARISTOR

产品直径 Φ 25
The diameter of the product with 25mm

8/20 μ s 冲击	20KA	≥ 1 次
8/20 μ s 冲击	5KA	≥ 40 次
2ms 冲击	220A	≥ 1 次
10/1000 μ s 冲击	400A	≥ 1 次



测试报告 TESTING REPORT





通用压敏电阻 GENERAL VARISTOR

应用领域 APPLICATIONS

抑制消费类电子产品及工业用电子设备主电源所窜入的浪涌电流。如LED照明、电度表、开关电源、排插等。

通信等有线网络设备窜入的浪涌电流。

房舍装置以及瓦斯和油类设施上所装置的电子器材的浪涌保护。

抑制电子线路内发生的浪涌。

照像器材等用于限压开关。

Suppression of surge current in consumer electronic and industrial electronic. Such as LED Lighting, Energy Meter, Switch, Power strip etc.

Suppression of surge current in communication and cable network equipment.

Surge protection on electronic equipments, which are set of Premises device, Gas and Oil facilities.

Suppression of internally generated spikes in electronics circuits.

Photographic Apparatus and so on which used as limiting voltage switch in photographic equipment.

HEL产品料号代码 HOW TO ORDER

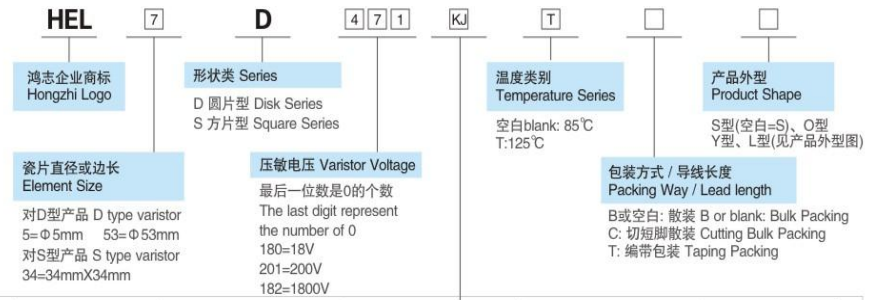

□中的内容 the content of the blank box	K	KJ	KH	KH+
产品级别 Product Level	普通型 Conventional Type	加强型 Enhanced Version	超强型 Super Enhanced Version	订制型 Custom made Version
性能参数 Property Parameters	1次脉冲最大电流 Withstanding Surge Current (Imax) (A)	电压冲击15次 Impulse Voltage 15 times (1.2/50 μs) (V)	1次脉冲最大电流 Withstanding Surge Current (Imax) (A)	1次脉冲最大电流 Withstanding Surge Current (Imax) (A)
	5D 7D 10D 14D 20D	400 1200 2500 4500 6500	1000 2000 4000 6000 10000	250 500 1500 3000 5000
符合国际及国家标准 In accordance with International and National Standards	IEC61051-1 IEC61051-2 IEC61051-2-2 CSA-C22.2 UL1449第三版。 The third edition of UL1449	GB/T10193 GB/T10194 GB/T10195 The third edition of UL1449	包含左栏,并增加以下标准: Include the left column, and add the following: IEC60950-1:2005/Annex Q GB4943.1-2011 GB8898-2011 UL1449 第四版。 The fourth edition of UL1449	包含左栏,并增加以下标准: Include the left column, and add the following: IEC61000-4-5 GB/T17626.5 IEC61643-331 GB/T18802.331
				超出左栏的脉冲标准的特殊规格 Super High Energy
				举例1 Example 14D满足20D的脉冲性能要求 14D instead of 20D
				举例2 Example HEL14D561KH+能达到6KV/3KA 100次 HEL14D561KH+ reach 6KV/3KA 100 times

备注: ①上表仅适用于压敏电压82V以上规格的产品。②上表“电压冲击”15次/40次仅适用于压敏电压430V及其以上规格的产品。
Remark: 1. The above form is only applicable to the products which with the varistor voltage more than 82V.
2. The Impulse voltage testing standards(1.2/50 μs) with 15 times / 40 times are only applicable to the products which with the varistor voltage more than 430V.

产品外型 PRODUCT SHAPE

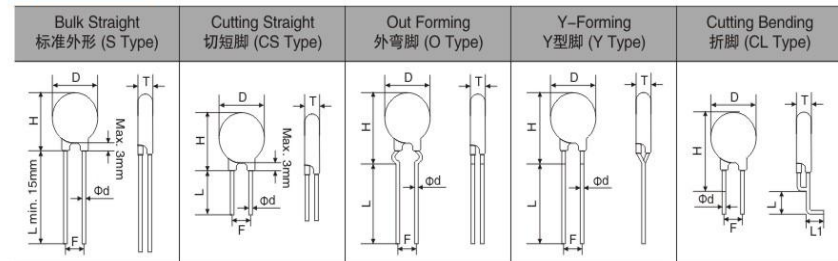

5D系列 HEL 压敏电阻 HEL VARISTOR WITH 5MM DIAMETER

型号规格 Part No.	压敏电压 Varistor Voltage		最大允许 使用电压 Maximum Allowable Voltage		最大限制 电压 Maximum Clamping Voltage	通流量 Withstanding Surge Current (8/20 μs) 1 time		静态功率 Rated Wattage	能量耐量 Energy (2ms)		静态电容量 (参考值) Typical Capacitance
	V _{1mA} (V)	AC (V)	DC (V)	V _{5A} (V)		K class (A)	KJ class (A)		(W)	K (J)	
HEL-5D180	18	(16-20)	11	14	· 40	100	250	0.01	0.3	0.4	2,400
HEL-5D220	22	(20-24)	14	18	· 48	100	250	0.01	0.4	0.5	1,800
HEL-5D270	27	(24-30)	17	22	· 60	100	250	0.01	0.5	0.6	1,500
HEL-5D330	33	(30-36)	20	26	· 73	100	250	0.01	0.6	0.7	1,200
HEL-5D390	39	(35-43)	25	31	· 86	100	250	0.01	0.7	0.9	1,000
HEL-5D470	47	(42-52)	30	38	· 104	100	250	0.01	0.8	1.1	850
HEL-5D560	56	(50-62)	35	45	· 123	100	250	0.01	1.0	1.3	700
HEL-5D680	68	(61-75)	40	56	· 150	100	250	0.01	1.2	1.5	560
HEL-5D820	82	(74-90)	50	65	145	400	800	0.1	1.5	1.8	480
HEL-5D101	100	(90-110)	60	85	175	400	800	0.1	1.8	2.3	420
HEL-5D121	120	(108-132)	75	100	210	400	800	0.1	2.2	2.7	360
HEL-5D151	150	(135-165)	95	125	260	400	800	0.1	2.7	3.4	280
HEL-5D181	180	(162-198)	115	150	320	400	800	0.1	3.2	4.1	200
HEL-5D201	200	(180-220)	130	170	355	400	800	0.1	3.6	4.5	160
HEL-5D221	220	(198-242)	140	180	380	400	800	0.1	4.0	5.0	110
HEL-5D241	240	(216-264)	150	200	415	400	800	0.1	4.3	5.4	85
HEL-5D271	270	(243-297)	175	225	475	400	800	0.1	4.9	6.1	75
HEL-5D301	300	(270-330)	195	250	525	400	800	0.1	5.4	6.8	75
HEL-5D331	330	(297-363)	210	275	575	400	800	0.1	5.9	7.4	75
HEL-5D361	360	(324-396)	230	300	620	400	800	0.1	6.5	8.1	70
HEL-5D391	390	(351-429)	250	320	675	400	800	0.1	7.0	8.8	70
HEL-5D431	430	(387-473)	275	350	745	400	800	0.1	7.7	9.7	65
HEL-5D471	470	(423-517)	300	385	810	400	800	0.1	8.5	10.6	55
HEL-5D511	510	(459-561)	320	418	882	400	800	0.1	9.2	11.5	55
HEL-5D561	560	(504-616)	350	460	968	400	800	0.1	10.1	12.6	50
HEL-5D621	620	(558-682)	385	505	1072	400	800	0.1	11.2	14.0	45
HEL-5D681	680	(612-748)	420	560	1176	400	800	0.1	12.2	15.3	40
HEL-5D751	750	(675-825)	460	615	1300	400	800	0.1	13.5	16.8	35

• The clamping voltage from 180K to 680K is tested with current 1A,
Note: The energy (10/1000 μs) is about 1.4 times of energy (2ms).
• 180K至680K最大限制电压测试电流是1A。
注: 10/1000 μs的能量耐量值约为2ms能量耐量值的1.4倍

降额曲线图 Derating curves

横轴是冲击时间即浪涌波型宽度, 纵轴是冲击电流峰值,
线上的数字是冲击次数;
Maximum surge current $i_{max} = f(t_r, \text{pulse train})$

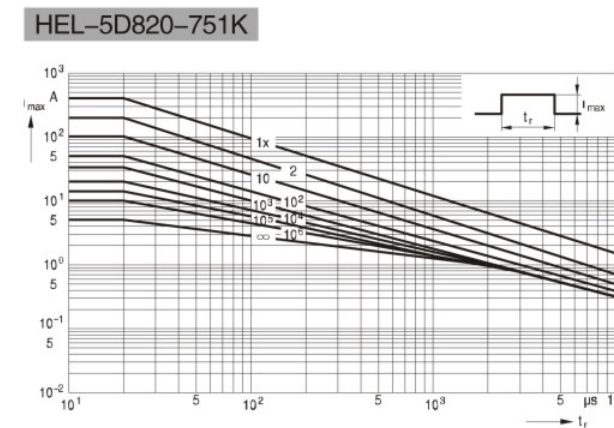
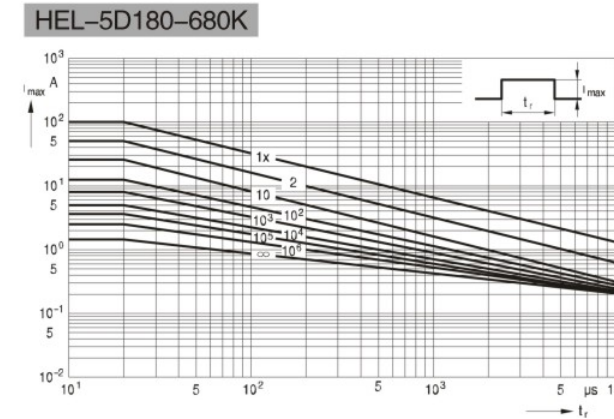

伏安特性图 v/i characteristics

A区是泄漏电流区, A = Leakage current,
B区是冲击电流与限制电压对应区
B = Protection level for worst-case varistor tolerances

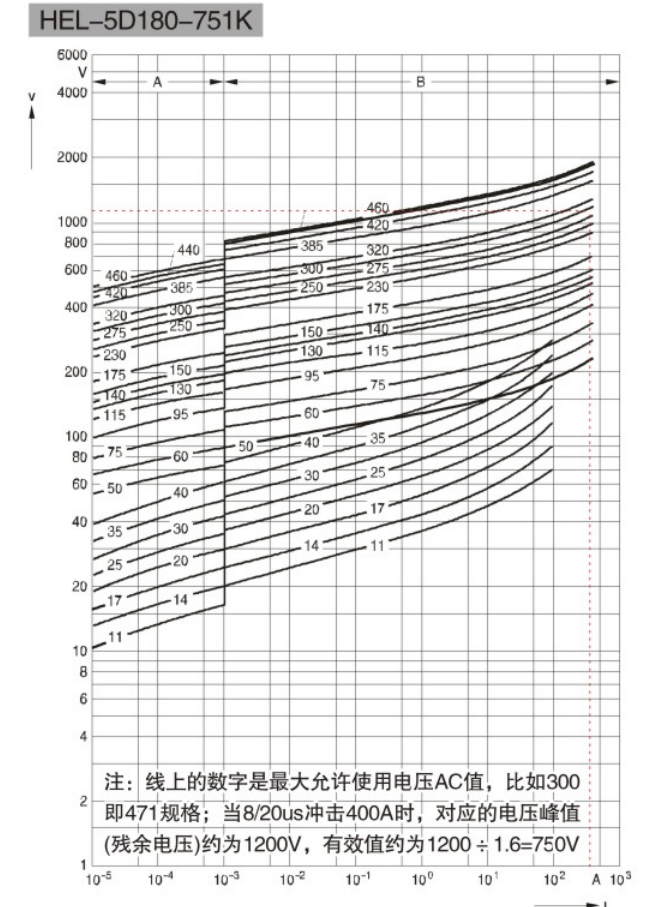

产品尺寸 DIMENSION

单位Unit: mm

产品外型 Product Shape	系列 Series	压敏电压 Varistor Voltage	厚度 Tmax
	5D	18V-39V	4.0
		47V-68V	4.5
		82V-150V	5.0
		180V-270V	5.5
		330V-390V	6.0
		430V-560V	6.5
		620V-750V	7.0

7D系列 HEL 压敏电阻 HEL VARISTOR WITH 7MM DIAMETER

型号规格 Part No.	压敏电压 Varistor Voltage		最大允许使用电压 Maximum Allowable Voltage		最大限制电压 Maximum Clamping Voltage		通流容量 Withstanding Surge Current (8/20 μs) 1 time		静态功率 Rated Wattage		能量耐量 Energy (2ms)		静态电容量 (参考值) Typical Capacitance
	V _{1mA} (V)	AC (V)	DC (V)	V _{10A} (V)	K class (A)	KJ class (A)	(W)	K (J)	KJ (J)	1kHz (PF)			
HEL-7D180	18	(16-20)	11	14	· 38	250	500	0.02	0.8	0.9	3,500		
HEL-7D220	22	(20-24)	14	18	· 43	250	500	0.02	0.9	1.2	2,800		
HEL-7D270	27	(24-30)	17	22	· 53	250	500	0.02	1.1	1.4	2,200		
HEL-7D330	33	(30-36)	20	26	· 65	250	500	0.02	1.4	1.7	1,800		
HEL-7D390	39	(35-43)	25	31	· 77	250	500	0.02	1.6	2.0	1,450		
HEL-7D470	47	(42-52)	30	38	· 93	250	500	0.02	2.0	2.5	1,150		
HEL-7D560	56	(50-62)	35	45	· 110	250	500	0.02	2.4	2.9	1,050		
HEL-7D680	68	(61-75)	40	56	· 135	250	500	0.02	2.9	3.6	970		
HEL-7D820	82	(74-90)	50	65	135	1200	1750	0.25	3.4	4.3	930		
HEL-7D101	100	(90-110)	60	85	165	1200	1750	0.25	4.2	5.3	860		
HEL-7D121	120	(108-132)	75	100	200	1200	1750	0.25	5.0	6.3	670		
HEL-7D151	150	(135-165)	95	125	250	1200	1750	0.25	6.3	7.9	490		
HEL-7D181	180	(162-198)	115	150	300	1200	1750	0.25	7.6	9.5	330		
HEL-7D201	200	(180-220)	130	170	340	1200	1750	0.25	8.4	10.5	240		
HEL-7D221	220	(198-242)	140	180	360	1200	1750	0.25	9.2	11.6	190		
HEL-7D241	240	(216-264)	150	200	395	1200	1750	0.25	10.1	12.6	165		
HEL-7D271	270	(243-297)	175	225	455	1200	1750	0.25	11.3	14.2	150		
HEL-7D301	300	(270-330)	195	250	505	1200	1750	0.25	12.6	15.8	135		
HEL-7D331	330	(297-363)	210	275	550	1200	1750	0.25	13.9	17.3	130		
HEL-7D361	360	(324-396)	230	300	595	1200	1750	0.25	15.1	18.9	125		
HEL-7D391	390	(351-429)	250	320	650	1200	1750	0.25	16.4	20.5	105		
HEL-7D431	430	(387-473)	275	350	710	1200	1750	0.25	18.1	22.6	100		
HEL-7D471	470	(423-517)	300	385	775	1200	1750	0.25	19.7	24.7	90		
HEL-7D511	510	(459-561)	320	418	842	1200	1750	0.25	21.4	26.8	80		
HEL-7D561	560	(504-616)	350	460	920	1200	1750	0.25	23.5	29.4	75		
HEL-7D621	620	(558-682)	385	505	1025	1200	1750	0.25	26.0	32.6	70		
HEL-7D681	680	(612-748)	420	560	1120	1200	1750	0.25	28.6	35.7	65		
HEL-7D751	750	(675-825)	460	615	1240	1200	1750	0.25	31.5	39.4	61		
HEL-7D781	780	(702-858)	485	640	1290	1200	1750	0.25	32.8	41.0	54		
HEL-7D821	820	(738-902)	510	670	1355	1200	1750	0.25	34.4	43.1	48		

• The clamping voltage from 180K to 680K is tested with current 2.5A,
Note: The energy (10/1000 μs) is about 1.4 times of energy (2ms).
• 180K至680K最大限制电压测试电流是2.5A.
注: 10/1000 μs的能量耐量值约为2ms能量耐量值的1.4倍

降额曲线图 Derating curves

横轴是冲击时间即浪涌波型宽度, 纵轴是冲击电流峰值, 线上的数字是冲击次数;
Maximum surge current $i_{max} = f(t_r, \text{pulse train})$

HEL-7D180-680K



HEL-7D820-751K



伏安特性图 v/i characteristics

A区是泄漏电流区, A = Leakage current,
B区是冲击电流与限制电压对应区
B = Protection level for worst-case varistor tolerances

HEL-7D180-751K



产品尺寸 DIMENSION

单位Unit: mm

产品外型 Product Shape	系列 Series	压敏电压 Varistor Voltage	厚度 Tmax
	7D	18V-39V	5.5
		47V-68V	6.0
		82V-150V	6.5
		180V-270V	7.0
		330V-390V	7.5
		430V-560V	8.0
		620V-780V	8.5
		820V	9.0

10D系列 HEL 压敏电阻 HEL VARISTOR WITH 10MM DIAMETER

型号规格 Part No.	压敏电压 Varistor Voltage		最大允许使用电压 Maximum Allowable Voltage		最大限制电压 Maximum Clamping Voltage		通流容量 Withstanding Surge Current (8/20 μs) 1 time		静态功率 Rated Wattage		能量耐量 Energy (2ms)		静态电容值 (参考值) Typical Capacitance
	V _{1mA} (V)	AC (V)	DC (V)	V _{25A} (V)	K class (A)	KJ class (A)	(W)	K (J)	KJ (J)	1kHz (PF)			
HEL-10D180	18	(16-20)	11	14	· 38	500	1000	0.05	1.6	2.0	7,500		
HEL-10D220	22	(20-24)	14	18	· 43	500	1000	0.05	2.0	2.5	6,000		
HEL-10D270	27	(24-30)	17	22	· 53	500	1000	0.05	2.4	3.0	4,800		
HEL-10D330	33	(30-36)	20	26	· 65	500	1000	0.05	3.0	3.7	4,200		
HEL-10D390	39	(35-43)	25	31	· 77	500	1000	0.05	3.5	4.4	3,700		
HEL-10D470	47	(42-52)	30	38	· 93	500	1000	0.05	4.2	5.3	3,300		
HEL-10D560	56	(50-62)	35	45	· 110	500	1000	0.05	5.0	6.3	2,900		
HEL-10D680	68	(61-75)	40	56	· 135	500	1000	0.05	6.1	7.7	2,500		
HEL-10D820	82	(74-90)	50	65	135	2500	3500	0.4	7.4	9.2	2,100		
HEL-10D101	100	(90-110)	60	85	165	2500	3500	0.4	9.0	11.3	1,700		
HEL-10D121	120	(108-132)	75	100	200	2500	3500	0.4	10.8	13.5	1,500		
HEL-10D151	150	(135-165)	95	125	250	2500	3500	0.4	13.5	16.9	1,300		
HEL-10D181	180	(162-198)	115	150	300	2500	3500	0.4	16.2	20.3	470		
HEL-10D201	200	(180-220)	130	170	340	2500	3500	0.4	18.0	22.5	430		
HEL-10D221	220	(198-242)	140	180	360	2500	3500	0.4	19.8	24.8	390		
HEL-10D241	240	(216-264)	150	200	395	2500	3500	0.4	21.6	27.0	360		
HEL-10D271	270	(243-297)	175	225	455	2500	3500	0.4	24.3	30.4	330		
HEL-10D301	300	(270-330)	195	250	505	2500	3500	0.4	27.0	33.8	290		
HEL-10D331	330	(297-363)	210	275	550	2500	3500	0.4	29.7	37.1	280		
HEL-10D361	360	(324-396)	230	300	595	2500	3500	0.4	32.4	40.5	260		
HEL-10D391	390	(351-429)	250	320	650	2500	3500	0.4	35.1	43.9	240		
HEL-10D431	430	(387-473)	275	350	710	2500	3500	0.4	38.7	48.4	220		
HEL-10D471	470	(423-517)	300	385	775	2500	3500	0.4	42.3	52.9	190		
HEL-10D511	510	(459-561)	320	418	842	2500	3500	0.4	42.3	52.9	180		
HEL-10D561	560	(504-616)	350	460	920	2500	3500	0.4	42.3	52.9	180		
HEL-10D621	620	(558-682)	385	505	1,025	2500	3500	0.4	42.3	52.9	160		
HEL-10D681	680	(612-748)	420	560	1,120	2500	3500	0.4	42.3	52.9	140		
HEL-10D751	750	(675-825)	460	615	1,240	2500	3500	0.4	42.3	52.9	130		
HEL-10D781	780	(702-858)	485	640	1,290	2500	3500	0.4	42.3	52.9	130		
HEL-10D821	820	(738-902)	510	670	1,355	2500	3500	0.4	44.3	55.4	130		
HEL-10D911	910	(819-1001)	550	745	1,500	2500	3500	0.4	49.1	61.4	120		
HEL-10D951	950	(855-1045)	580	780	1,570	2500	3500	0.4	51.3	64.1	110		
HEL-10D102	1000	(900-1100)	625	825	1,650	2500	3500	0.4	54.0	67.5	100		
HEL-10D112	1100	(990-1210)	680	895	1,815	2500	3500	0.4	59.4	74.3	90		
HEL-10D152	1500	(1350-1650)	900	1220	2,475	2500	3500	0.4	80.0	100.0	80		
HEL-10D182	1800	(1620-1980)	1000	1465	2,970	2500	3500	0.4	97.2	121.5	60		

• The clamping voltage from 180K to 680K is tested with current 5A, Note: The energy (10/1000 μs) is about 1.4 times of energy (2ms).
 • 180K至680K最大限制电压测试电流是5A。
 注: 10/1000 μs的能量耐量值约为2ms能量耐量值的1.4倍

降额曲线图 Derating curves

横轴是冲击时间即浪涌波型宽度, 纵轴是冲击电流峰值, 线上的数字是冲击次数; Maximum surge current $i_{max} = f(t_r, \text{pulse train})$

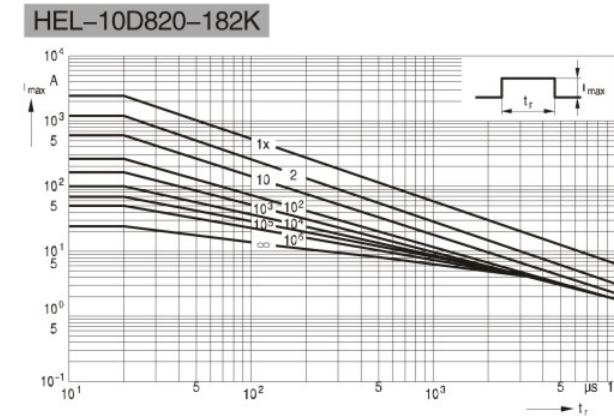
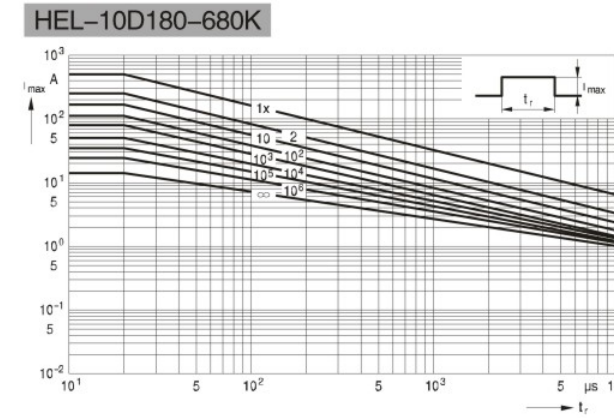

伏安特性图 v/i characteristics

A区是泄漏电流区, A = Leakage current, B区是冲击电流与限制电压对应区 B = Protection level for worst-case varistor tolerances

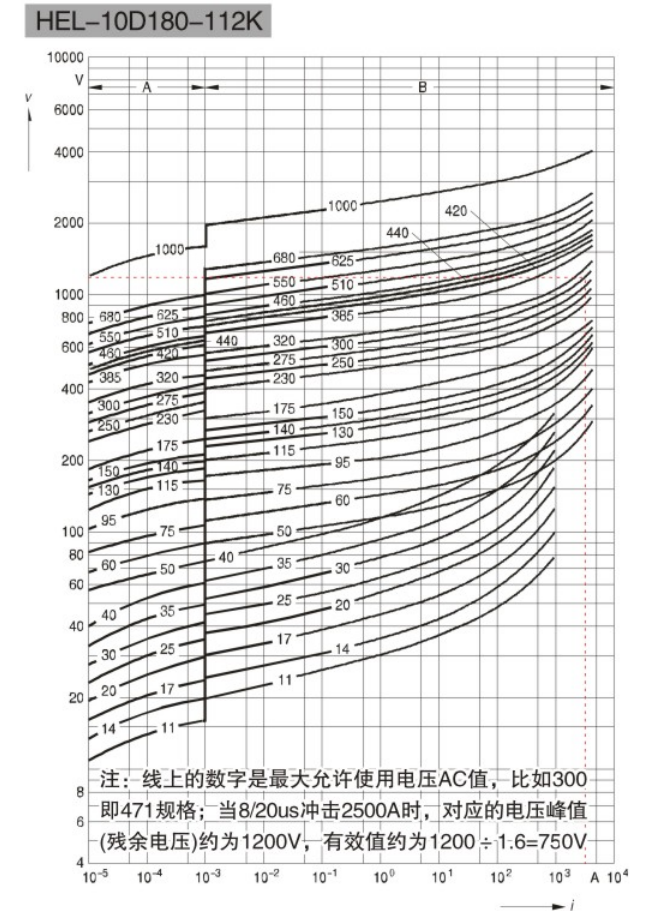

产品尺寸 DIMENSION

单位Unit: mm

产品外型 Product Shape	系列 Series	压敏电压 Varistor Voltage	厚度 Tmax
	10D	18V-39V	6.5
		47V-68V	7.0
		82V-150V	7.5
		180V-270V	8.0
		330V-390V	8.5
		430V-560V	9.0
		620V-780V	9.5
		820V-1200V	10.0
		1300V-1500V	10.5
		1600V-1800V	11.0

14D系列 HEL 压敏电阻 HEL VARISTOR WITH 14MM DIAMETER

型号规格 Part No.	压敏电压 Varistor Voltage		最大允许使用电压 Maximum Allowable Voltage		最大限制电压 Maximum Clamping Voltage		通流容量 Withstanding Surge Current (8/20 μs) 1 time		静态功率 Rated Wattage		能量耐量 Energy (2ms)		静态电容值 (参考值) Typical Capacitance
	V _{1mA} (V)	AC (V)	DC (V)	V _{50A} (V)	K class (A)	KJ class (A)	(W)	K (J)	KJ (J)	1kHz (PF)			
HEL-14D180	18	(16-20)	11	14	· 38	1000	2000	0.1	3.2	4.1	18,000		
HEL-14D220	22	(20-24)	14	18	· 43	1000	2000	0.1	4.0	5.0	15,000		
HEL-14D270	27	(24-30)	17	22	· 53	1000	2000	0.1	4.9	6.1	10,000		
HEL-14D330	33	(30-36)	20	26	· 65	1000	2000	0.1	5.9	7.4	8,500		
HEL-14D390	39	(35-43)	25	31	· 77	1000	2000	0.1	7.0	8.8	7,500		
HEL-14D470	47	(42-52)	30	38	· 93	1000	2000	0.1	8.5	10.6	6,500		
HEL-14D560	56	(50-62)	35	45	· 110	1000	2000	0.1	10.1	12.6	5,600		
HEL-14D680	68	(61-75)	40	56	· 135	1000	2000	0.1	12.2	15.3	4,700		
HEL-14D820	82	(74-90)	50	65	135	4500	6000	0.6	14.8	18.5	3,900		
HEL-14D101	100	(90-110)	60	85	165	4500	6000	0.6	18.0	22.5	3,400		
HEL-14D121	120	(108-132)	75	100	200	4500	6000	0.6	21.6	27.0	3,100		
HEL-14D151	150	(135-165)	95	125	250	4500	6000	0.6	27.0	33.8	3,000		
HEL-14D181	180	(162-198)	115	150	300	4500	6000	0.6	32.4	40.5	1,030		
HEL-14D201	200	(185-225)	130	170	340	4500	6000	0.6	36.0	45.0	970		
HEL-14D221	220	(198-242)	140	180	360	4500	6000	0.6	39.6	49.5	840		
HEL-14D241	240	(216-264)	150	200	395	4500	6000	0.6	43.2	54.0	710		
HEL-14D271	270	(243-297)	175	225	455	4500	6000	0.6	48.6	60.8	650		
HEL-14D301	300	(270-330)	195	250	505	4500	6000	0.6	54.0	67.5	600		
HEL-14D331	330	(297-363)	210	275	550	4500	6000	0.6	59.4	74.3	550		
HEL-14D361	360	(324-396)	230	300	595	4500	6000	0.6	64.8	81.0	500		
HEL-14D391	390	(351-429)	250	320	650	4500	6000	0.6	70.2	87.8	480		
HEL-14D431	430	(387-473)	275	350	710	4500	6000	0.6	77.4	96.8	440		
HEL-14D471	470	(423-517)	300	385	775	4500	6000	0.6	84.6	105.8	420		
HEL-14D511	510	(459-561)	320	418	842	4500	6000	0.6	84.6	105.8	390		
HEL-14D561	560	(504-616)	350	460	920	4500	6000	0.6	84.6	105.8	360		
HEL-14D621	620	(558-682)	385	505	1,025	4500	6000	0.6	84.6	105.8	320		
HEL-14D681	680	(612-748)	420	560	1,120	4500	6000	0.6	84.6	105.8	290		
HEL-14D751	750	(675-825)	460	615	1,240	4500	6000	0.6	90.0	112.5	260		
HEL-14D781	780	(702-858)	485	640	1,290	4500	6000	0.6	93.6	117.0	230		
HEL-14D821	820	(738-902)	510	670	1,355	4500	6000	0.6	98.4	123.0	230		
HEL-14D911	910	(819-1001)	550	745	1,500	4500	6000	0.6	109.2	136.5	200		
HEL-14D951	950	(855-1045)	580	780	1,570	4500	6000	0.6	113.7	142.1	190		
HEL-14D102	1000	(900-1100)	625	825	1,650	4500	6000	0.6	120.0	150.0	180		
HEL-14D112	1100	(990-1210)	680	895	1,815	4500	6000	0.6	132.0	165.0	150		
HEL-14D152	1500	(1350-1650)	900	1220	2,475	4500	6000	0.6	179.0	223.0	140		
HEL-14D182	1800	(1620-1980)	1,000	1,465	2,970	4500	6000	0.6	216.0	270.0	120		

• The clamping voltage from 180K to 680K is tested with current 10A,
Note: The energy (10/1000 μs) is about 1.4 times of energy (2ms).
• 180K至680K最大限制电压测试电流是10A。
注: 10/1000 μs的能量耐量值约为2ms能量耐量值的1.4倍

降额曲线图 Derating curves

横轴是冲击时间即浪涌波型宽度, 纵轴是冲击电流峰值, 线上的数字是冲击次数;
Maximum surge current $i_{max} = f(t_r, \text{pulse train})$

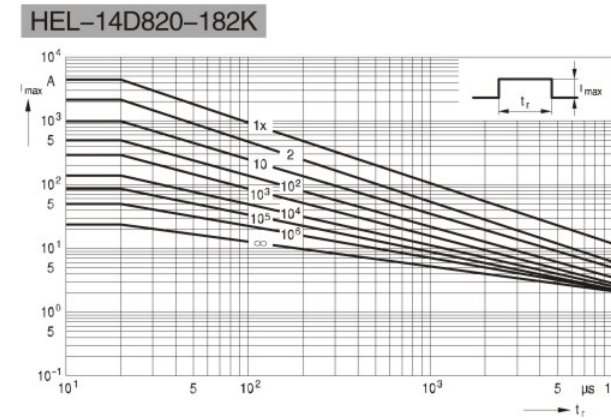
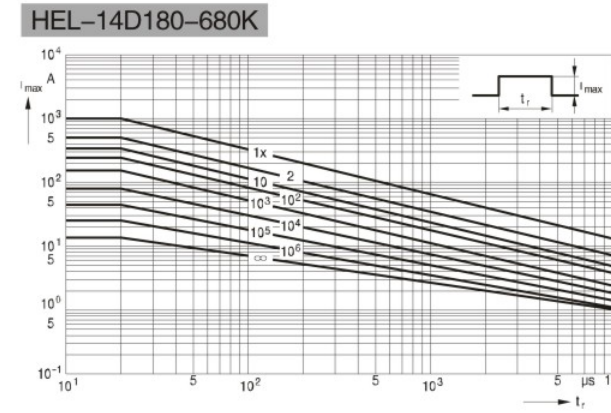

伏安特性图 v/i characteristics

A区是泄漏电流区, A = Leakage current,
B区是冲击电流与限制电压对应区
B = Protection level for worst-case varistor tolerances

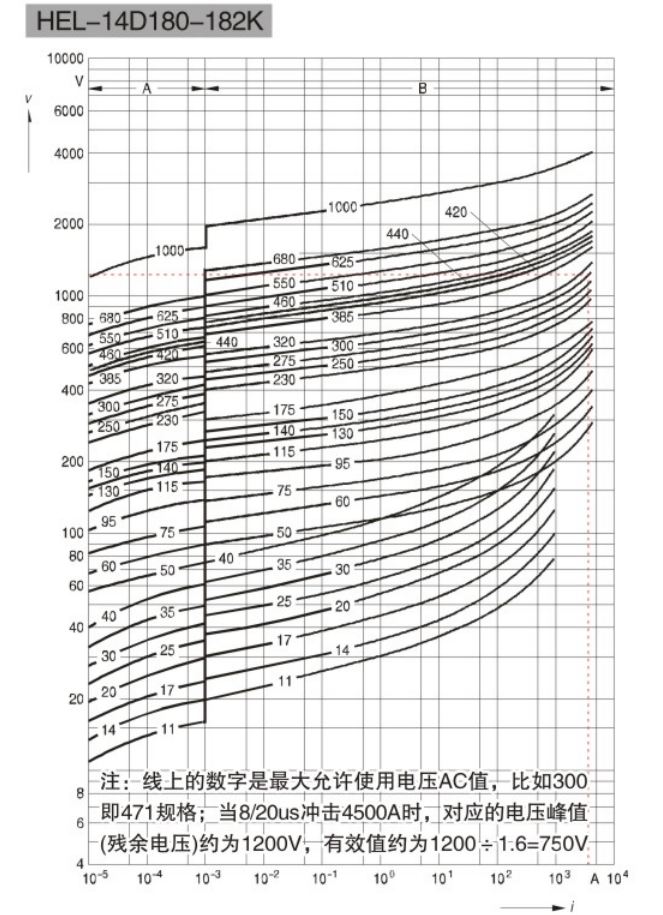

产品尺寸 DIMENSION

单位Unit: mm

产品外型 Product Shape	系列 Series	压敏电压 Varistor Voltage	厚度 Tmax
	14D	18V-39V	7.5
		47V-68V	8.0
		82V-150V	8.5
		180V-270V	9.0
		330V-390V	9.5
		430V-560V	10.0
		620V-780V	10.5
		820V-1200V	11.0
		1300V-1500V	11.5
		1600V-1800V	12.0

20D系列 HEL 压敏电阻 HEL VARISTOR WITH 20MM DIAMETER

型号规格 Part No.	压敏电压 Varistor Voltage		最大允许使用电压 Maximum Allowable Voltage		最大限制电压 Maximum Clamping Voltage	通流容量 Withstanding Surge Current (8/20 μs) 1 time		静态功率 Rated Wattage		能量耐量 Energy (2ms)		静态电容量 (参考值) Typical Capacitance
	V _{1mA} (V)	AC (V)	DC (V)	V _{100A} (V)		K class (A)	KJ class (A)	(W)	K (J)	KJ (J)	1kHz (PF)	
HEL-20D180	18	(16-20)	11	14	· 38	2,000	3,000	0.2	5.4	6.8	39,000	
HEL-20D220	22	(20-24)	14	18	· 43	2,000	3,000	0.2	6.6	8.3	32,000	
HEL-20D270	27	(24-30)	17	22	· 53	2,000	3,000	0.2	8.1	10.1	22,000	
HEL-20D330	33	(30-36)	20	26	· 65	2,000	3,000	0.2	9.9	12.4	18,000	
HEL-20D390	39	(35-43)	25	31	· 77	2,000	3,000	0.2	11.7	14.6	16,000	
HEL-20D470	47	(42-52)	30	38	· 93	2,000	3,000	0.2	14.1	17.6	14,000	
HEL-20D560	56	(50-62)	35	45	· 110	2,000	3,000	0.2	16.8	21.0	12,000	
HEL-20D680	68	(61-75)	40	56	· 135	2,000	3,000	0.2	20.4	25.5	10,000	
HEL-20D820	82	(74-90)	50	65	135	6,500	10,000	1.0	24.6	30.8	5,800	
HEL-20D101	100	(90-110)	60	85	165	6,500	10,000	1.0	30.0	37.5	4,800	
HEL-20D121	120	(108-132)	75	100	200	6,500	10,000	1.0	36.0	45.0	3,800	
HEL-20D151	150	(135-165)	95	125	250	6,500	10,000	1.0	45.0	56.3	3,000	
HEL-20D181	180	(162-198)	115	150	300	6,500	10,000	1.0	54.0	67.5	2,600	
HEL-20D201	200	(185-225)	130	170	340	6,500	10,000	1.0	60.0	75.0	2,400	
HEL-20D221	220	(198-242)	140	180	360	6,500	10,000	1.0	66.0	82.5	1,800	
HEL-20D241	240	(216-264)	150	200	395	6,500	10,000	1.0	72.0	90.0	1,500	
HEL-20D271	270	(243-297)	175	225	455	6,500	10,000	1.0	81.0	101.3	1,400	
HEL-20D301	300	(270-330)	195	250	505	6,500	10,000	1.0	90.0	112.5	1,350	
HEL-20D331	330	(297-363)	210	275	550	6,500	10,000	1.0	99.0	123.8	1,300	
HEL-20D361	360	(324-396)	230	300	595	6,500	10,000	1.0	108.0	135.0	1,250	
HEL-20D391	390	(351-429)	250	320	650	6,500	10,000	1.0	117.0	146.3	1,180	
HEL-20D431	430	(387-473)	275	350	710	6,500	10,000	1.0	129.0	161.3	1,100	
HEL-20D471	470	(423-517)	300	385	775	6,500	10,000	1.0	141.0	176.3	1,050	
HEL-20D511	510	(459-561)	320	418	842	6,500	10,000	1.0	153.0	191.3	1,000	
HEL-20D561	560	(504-616)	350	460	920	6,500	10,000	1.0	168.0	210.0	970	
HEL-20D621	620	(558-682)	385	505	1,025	6,500	10,000	1.0	186.0	232.5	950	
HEL-20D681	680	(612-748)	420	560	1,120	6,500	10,000	1.0	186.0	232.5	900	
HEL-20D751	750	(675-825)	460	615	1,240	6,500	10,000	1.0	186.0	232.5	850	
HEL-20D781	780	(702-858)	485	640	1,290	6,500	10,000	1.0	187.2	234.0	750	
HEL-20D821	820	(738-902)	510	670	1,355	6,500	10,000	1.0	196.8	246.0	700	
HEL-20D911	910	(819-1001)	550	745	1,500	6,500	10,000	1.0	218.4	273.0	600	
HEL-20D951	950	(855-1045)	580	780	1,570	6,500	10,000	1.0	228.0	285.0	580	
HEL-20D102	1000	(900-1100)	625	825	1,650	6,500	10,000	1.0	240.0	300.0	500	
HEL-20D112	1100	(990-1210)	680	895	1,815	6,500	10,000	1.0	264.0	330.0	450	
HEL-20D152	1500	(1350-1650)	900	1,220	2,475	6,500	10,000	1.0	359.0	449.0	400	
HEL-20D182	1800	(1620-1980)	1,000	1,465	2,970	6,500	10,000	1.0	432.0	540.0	220	

• The clamping voltage from 180K to 680K is tested with current 25A, Note: The energy (10/1000 μs) is about 1.4 times of energy (2ms).
 • 180K至680K最大限制电压测试电流是 25A.
 注: 10/1000 μs的能量耐量值约为2ms能量耐量值的1.4倍

降额曲线图 Derating curves

横轴是冲击时间即浪涌波型宽度, 纵轴是冲击电流峰值, 线上的数字是冲击次数;
 Maximum surge current $i_{max} = f(t_r, \text{pulse train})$

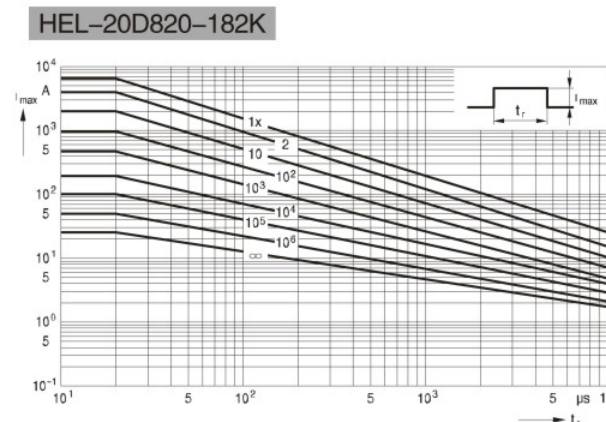
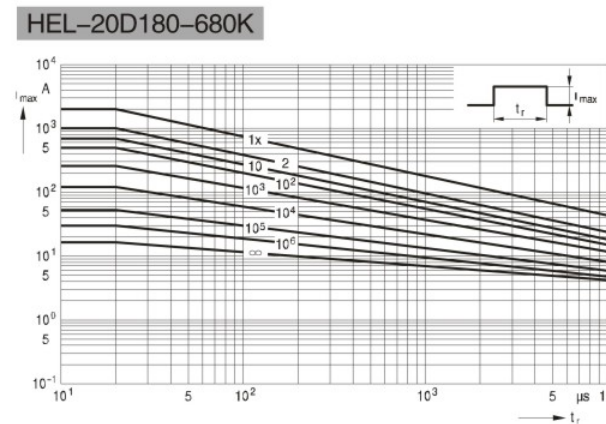

伏安特性图 v/i characteristics

A区是泄漏电流区, A = Leakage current, B区是冲击电流与限制电压对应区
 B = Protection level for worst-case varistor tolerances

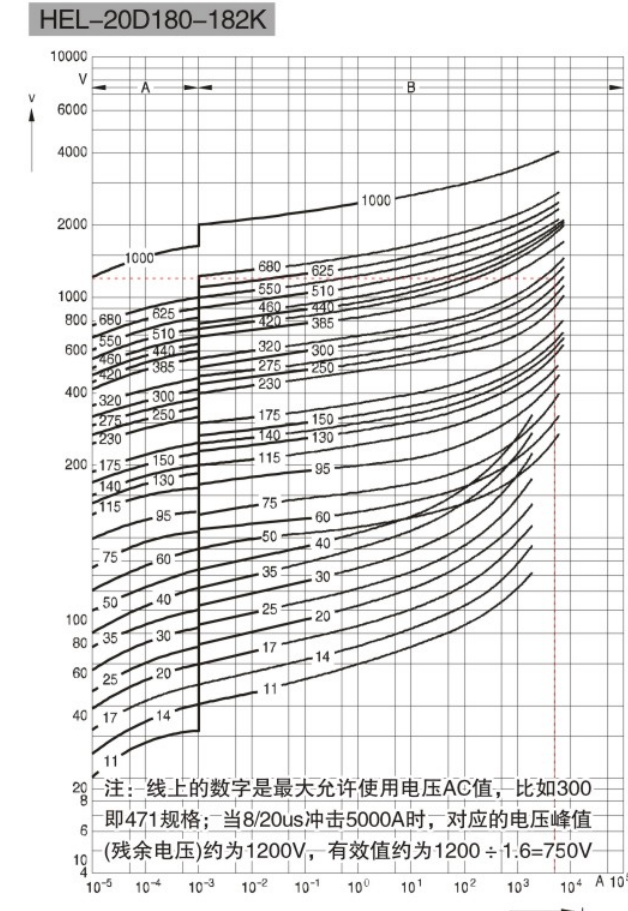

产品尺寸 DIMENSION

单位Unit: mm

产品外型 Product Shape	系列 Series	压敏电压 Varistor Voltage	厚度 Tmax (mm)
	20D	18V-39V	8.5
		47V-68V	9.0
		82V-150V	9.5
		180V-270V	10.0
		330V-390V	10.5
		430V-560V	11.0
		620V-780V	11.5
		820V-1200V	12.0
		1300V-1500V	12.5
		1600V-1800V	13.0



高能压敏电阻 HIGH ENERGY VARISTOR

应用领域 APPLICATIONS

- 通讯基站电源; communication station power
- 铁路信号电源; railway signal power supply
- 1000V以下低压配电设备、控制设备等等。
Below 1000 volts, low-voltage distribution equipment, control equipment etc.
- 楼宇配电; building distribution
- 电焊机; electric welding machine

25D系列 HEL 压敏电阻 HEL VARISTOR WITH 25MM DIAMETER

型号规格 Part No.	压敏电压 Varistor Voltage	最大允许 使用电压 Maximum Allowable Voltage		最大限制 电压 Maximum Clamping Voltage	通流容量 Withstanding Surge Current (8/20 μs)		静态功率 Rated Wattage	能量耐量 Energy (2ms)
	V _{1mA} (V)	AC (V)	DC (V)	V (150A)	I _{max} (kA)	I _n (kA)	(W)	(J)
HEL-25D201K	200(185-225)	130	170	340	15	5	1.0	125
HEL-25D221K	220(198-242)	140	180	360	15	5	1.0	130
HEL-25D241K	240(216-264)	150	200	395	15	5	1.0	145
HEL-25D271K	270(243-297)	175	225	455	15	5	1.0	170
HEL-25D301K	300(270-330)	190	245	500	15	5	1.0	180
HEL-25D331K	330(297-363)	210	270	545	15	5	1.0	185
HEL-25D361K	360(324-396)	230	300	595	15	5	1.0	190
HEL-25D391K	390(351-429)	250	320	650	15	5	1.0	210
HEL-25D431K	430(387-473)	275	350	710	15	5	1.0	225
HEL-25D471K	470(423-517)	300	385	775	15	5	1.0	225
HEL-25D511K	510(459-561)	320	415	845	15	5	1.0	230
HEL-25D561K	560(504-616)	350	460	925	15	5	1.0	230
HEL-25D621K	620(558-682)	385	505	1025	15	5	1.0	230
HEL-25D681K	680(612-748)	420	560	1120	15	5	1.0	250
HEL-25D821K	820(738-902)	510	670	1355	15	5	1.0	300
HEL-25D911K	910(819-1001)	550	745	1500	15	5	1.0	340
HEL-25D102K	1000(900-1100)	625	825	1650	15	5	1.0	375
HEL-25D122K	1200(1080-1320)	750	980	1980	15	5	1.0	400
HEL-25D152K	1500(1350-1650)	900	1220	2475	15	5	1.0	500
HEL-25D182K	1800(1620-1980)	1000	1465	2970	15	5	1.0	700

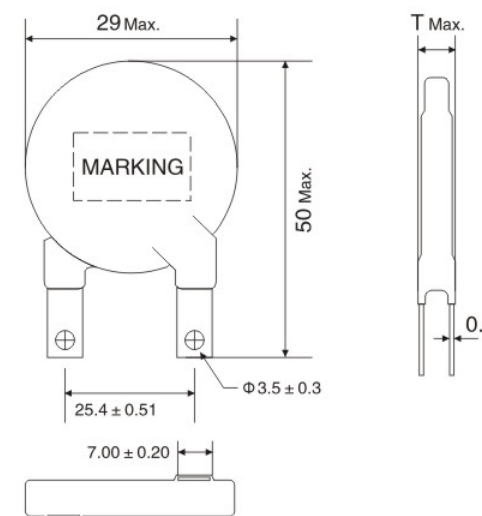

单位Unit: mm

规格 Part No.	厚度 Tmax
201-271	11
301-621	12
681-911	14
102-122	16
142-182	18

32D系列 HEL 压敏电阻 HEL VARISTOR WITH 32MM DIAMETER

型号规格 Part No.	压敏电压 Varistor Voltage	最大允许 使用电压 Maximum Allowable Voltage		最大限制 电压 Maximum Clamping Voltage	通流容量 Withstanding Surge Current (8/20 μ s)		静态功率 Rated Wattage	能量耐量 Energy (2ms)
		V _{1mA} (V)	AC (V)		DC (V)	V (200A)		
HEL-32D201K	200(185-225)	130	170	340	20	10	1.2	210
HEL-32D221K	220(198-242)	140	180	360	20	10	1.2	220
HEL-32D241K	240(216-264)	150	200	395	20	10	1.2	240
HEL-32D271K	270(243-297)	175	225	455	20	10	1.2	255
HEL-32D301K	300(270-330)	190	245	500	20	10	1.2	275
HEL-32D331K	330(297-363)	210	270	545	20	10	1.2	300
HEL-32D361K	360(324-396)	230	300	595	20	10	1.2	325
HEL-32D391K	390(351-429)	250	320	650	20	10	1.2	350
HEL-32D431K	430(387-473)	275	350	710	20	10	1.2	400
HEL-32D471K	470(423-517)	300	385	775	20	10	1.2	405
HEL-32D511K	510(459-561)	320	415	845	20	10	1.2	405
HEL-32D561K	560(504-616)	350	460	925	20	10	1.2	410
HEL-32D621K	620(558-682)	385	505	1025	20	10	1.2	415
HEL-32D681K	680(612-748)	420	560	1120	20	10	1.2	450
HEL-32D821K	820(738-902)	510	670	1355	20	10	1.2	545
HEL-32D911K	910(819-1001)	550	745	1500	20	10	1.2	600
HEL-32D102K	1000(900-1100)	625	825	1650	20	10	1.2	620
HEL-32D122K	1200(1080-1320)	750	980	1980	20	10	1.2	630
HEL-32D152K	1500(1350-1650)	900	1220	2475	20	10	1.2	780
HEL-32D182K	1800(1620-1980)	1000	1465	2970	20	10	1.2	850

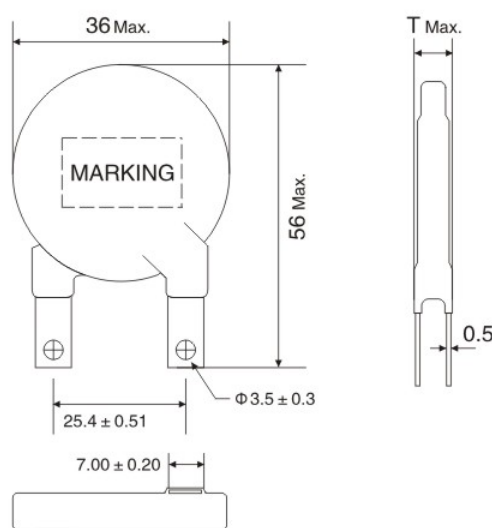

单位Unit: mm

规格 Part No.	厚度 Tmax
201-271	11
301-621	12
681-911	14
102-122	16
142-182	18

40D系列 HEL 压敏电阻 HEL VARISTOR WITH 40MM DIAMETER

型号规格 Part No.	压敏电压 Varistor Voltage	最大允许 使用电压 Maximum Allowable Voltage		最大限制 电压 Maximum Clamping Voltage	通流容量 Withstanding Surge Current (8/20 μ s)		静态功率 Rated Wattage	能量耐量 Energy (2ms)
		V _{1mA} (V)	AC (V)		DC (V)	V (300A)		
HEL-40D201K	200(185-225)	130	170	340	40	20	1.4	260
HEL-40D221K	220(198-242)	140	180	360	40	20	1.4	280
HEL-40D241K	240(216-264)	150	200	395	40	20	1.4	300
HEL-40D271K	270(243-297)	175	225	455	40	20	1.4	340
HEL-40D301K	300(270-330)	190	245	500	40	20	1.4	360
HEL-40D331K	330(297-363)	210	270	545	40	20	1.4	380
HEL-40D361K	360(324-396)	230	300	595	40	20	1.4	405
HEL-40D391K	390(351-429)	250	320	650	40	20	1.4	435
HEL-40D431K	430(387-473)	275	350	710	40	20	1.4	500
HEL-40D471K	470(423-517)	300	385	775	40	20	1.4	505
HEL-40D511K	510(459-561)	320	415	845	40	20	1.4	505
HEL-40D561K	560(504-616)	350	460	925	40	20	1.4	510
HEL-40D621K	620(558-682)	385	505	1025	40	20	1.4	515
HEL-40D681K	680(612-748)	420	560	1120	40	20	1.4	560
HEL-40D821K	820(738-902)	510	670	1355	40	20	1.4	680
HEL-40D911K	910(819-1001)	550	745	1500	40	20	1.4	750
HEL-40D102K	1000(900-1100)	625	825	1650	40	20	1.4	780
HEL-40D122K	1200(1080-1320)	750	980	1980	40	20	1.4	800
HEL-40D152K	1500(1350-1650)	900	1220	2475	40	20	1.4	900
HEL-40D182K	1800(1620-1980)	1000	1465	2970	40	20	1.4	1080

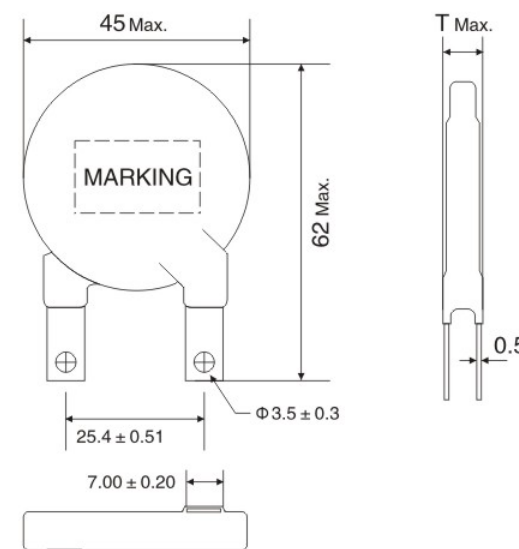

单位Unit: mm

规格 Part No.	厚度 Tmax
201-271	11
301-621	12
681-911	14
102-122	16
142-182	18

53D系列 HEL 压敏电阻 HEL VARISTOR WITH 53MM DIAMETER

型号规格 Part No.	压敏电压 Varistor Voltage		最大允许 使用电压 Maximum Allowable Voltage		最大限制 电压 Maximum Clamping Voltage	通流容量 Withstanding Surge Current (8/20 μs)		静态功率 Rated Wattage	能量耐量 Energy (2ms)
	V _{1mA} (V)		AC (V)	DC (V)	V (500A)	I _{max} (kA)	I _n (kA)	(W)	(J)
HEL-53D201K	200	185-225	130	170	340	70	30	1.6	330
HEL-53D221K	220	198-242	140	180	360	70	30	1.6	355
HEL-53D241K	240	216-264	150	200	395	70	30	1.6	380
HEL-53D271K	270	243-297	175	225	455	70	30	1.6	430
HEL-53D301K	300	270-330	190	245	500	70	30	1.6	455
HEL-53D331K	330	297-363	210	270	545	70	30	1.6	480
HEL-53D361K	360	324-396	230	300	595	70	30	1.6	510
HEL-53D391K	390	351-429	250	320	650	70	30	1.6	550
HEL-53D431K	430	387-473	275	350	710	70	30	1.6	635
HEL-53D471K	470	423-517	300	385	775	70	30	1.6	640
HEL-53D511K	510	459-561	320	415	845	70	30	1.6	640
HEL-53D561K	560	504-616	350	460	925	70	30	1.6	645
HEL-53D621K	620	558-682	385	505	1025	70	30	1.6	655
HEL-53D681K	680	612-748	420	560	1120	70	30	1.6	710
HEL-53D751K	750	675-825	460	615	1240	70	30	1.6	790
HEL-53D781K	780	702-858	485	640	1290	70	30	1.6	820
HEL-53D821K	820	738-902	510	670	1355	70	30	1.6	860
HEL-53D911K	910	819-1001	550	745	1500	70	30	1.6	950
HEL-53D102K	1000	900-1100	625	825	1650	70	30	1.6	990
HEL-53D122K	1200	1080-1320	750	980	1980	70	30	1.6	1015
HEL-53D152K	1500	1350-1650	900	1220	2475	70	30	1.6	1140
HEL-53D182K	1800	1620-1980	1000	1465	2970	70	30	1.6	1370

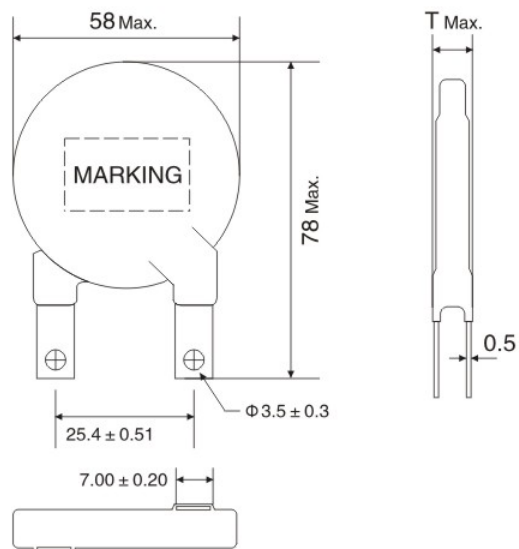

单位Unit: mm

规格 Part No.	厚度 Tmax
201-271	11
301-621	12
681-911	14
102-122	16
142-182	18

34S系列 HEL 方型压敏电阻 HEL VARISTOR WITH 34MM SQUARE

型号规格 Part No.	压敏电压 Varistor Voltage		最大允许 使用电压 Maximum Allowable Voltage		最大限制 电压 Maximum Clamping Voltage	通流容量 Withstanding Surge Current (8/20 μs)		静态功率 Rated Wattage	能量耐量 Energy (2ms)
	V _{1mA} (V)		AC (V)	DC (V)	V (300A)	I _{max} (kA)	I _n (kA)	(W)	(J)
HEL-34S201K	200	185-225	130	170	340	40	20	1.4	260
HEL-34S221K	220	198-242	140	180	360	40	20	1.4	280
HEL-34S241K	240	216-264	150	200	395	40	20	1.4	300
HEL-34S271K	270	243-297	175	225	455	40	20	1.4	340
HEL-34S301K	300	270-330	190	245	500	40	20	1.4	360
HEL-34S331K	330	297-363	210	270	545	40	20	1.4	380
HEL-34S361K	360	324-396	230	300	595	40	20	1.4	405
HEL-34S391K	390	351-429	250	320	650	40	20	1.4	435
HEL-34S431K	430	387-473	275	350	710	40	20	1.4	500
HEL-34S471K	470	423-517	300	385	775	40	20	1.4	505
HEL-34S511K	510	459-561	320	415	845	40	20	1.4	505
HEL-34S561K	560	504-616	350	460	925	40	20	1.4	510
HEL-34S621K	620	558-682	385	505	1025	40	20	1.4	515
HEL-34S681K	680	612-748	420	560	1120	40	20	1.4	560
HEL-34S821K	820	738-902	510	670	1355	40	20	1.4	680
HEL-34S911K	910	819-1001	550	745	1500	40	20	1.4	750
HEL-34S102K	1000	900-1100	625	825	1815	40	20	1.4	780
HEL-34S122K	1200	1080-1320	750	980	2000	40	20	1.4	800

产品厚度 Tmax

单位Unit: mm

规格 Part No.	Tmax
HEL-34S201K	11
HEL-34S221K	11
HEL-34S241K	11
HEL-34S271K	11
HEL-34S301K	12
HEL-34S331K	12
HEL-34S361K	12
HEL-34S391K	12
HEL-34S431K	12
HEL-34S471K	12
HEL-34S511K	12
HEL-34S561K	12
HEL-34S621K	12
HEL-34S681K	14
HEL-34S821K	14
HEL-34S911K	14
HEL-34S102K	16
HEL-34S122K	16

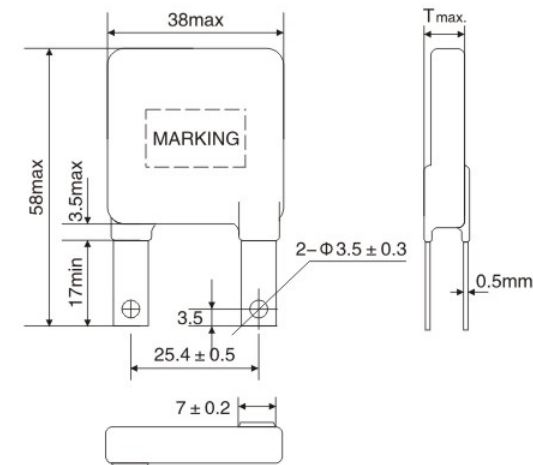

说明: 导电电极形状可按客户要求生产。
Option: The shape of conductive electrode can be customized.

其它异形产品

OTHER SPECIAL PRODUCTS

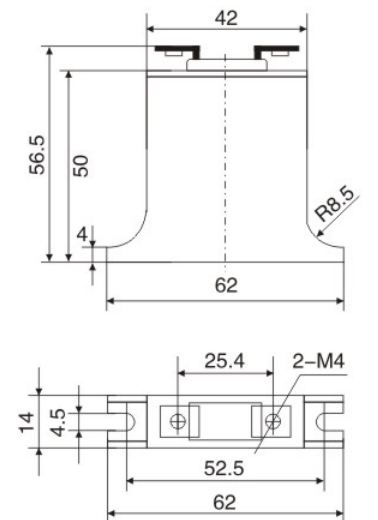



检测为鉴·品质如一

TESTING FOR AUTHENTICATION & CONSISTANT QUALITY

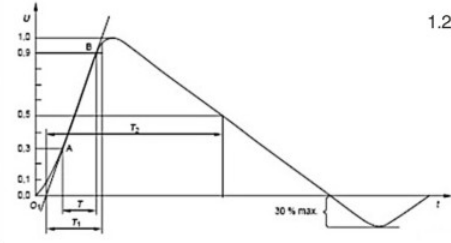
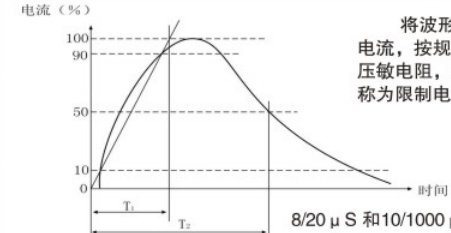

1.1 HEL压敏电阻技术术语 HEL VARISTOR TECHNICAL TERM

项目	标准术语	测试设备	要求
压敏电压	在标准测试条件*和直流1mA电流下，压敏电阻两端的电压，称为压敏电压。近似于拐点电压。用V _{1mA} 表示。	MYZ-5H型压敏电阻三参数测试仪	压敏电压测量值在偏差允许范围内： K: ±10%; L: ±15%。
漏电流	在标准测试条件*下，施加最大允许直流电压时，流过压敏电阻的电流值。	MYZ-5H型压敏电阻三参数测试仪	漏电流在规定的额定值内。(μA级)
最大允许使用电压	施加在压敏电阻上连续工作的最大直流电压或正弦波交流电压的有效值，为最大允许使用电压。	最大允许使用交流工频电压 ≈ 压敏电压的0.63倍。	实际使用的交流工频电压 ≈ 压敏电压的0.45倍。
组合波 开路为 1.2/50 μS 电压波 短路为 8/20 μS 电流波 6KV/3kA		脉冲发生器 记忆示波器	冲击规定次数后， 外观无可见损伤， 限制电压变化率 ≤ ±10%。
限制电压 8/20 μS 波形 10/1000 μS 波形		8/20 μS T1=8 μS ± 10% T2=20 μS ± 10% 10/1000 μS 波形 T1=10 ^{+100%} μS T2=1000 ± 20% μS 脉冲发生器 记忆示波器	限制电压小于规定的 额定值，各个规格规定 的电流峰值和限制 电压见本说明书。

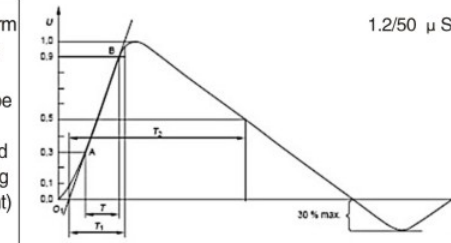
Item	Standard Terminology	Test equipment	Requirements
Varistor Voltage	The voltage between two terminals with the standard test conditions* and the specified measuring current 1mA DC applied is called varistor voltage. Similar to the knee-point voltage. With V _{1mA} said.	MYZ-5H type varistor three parameter tester	The allowable tolerance on varistor voltage is: K: ±-10% L: ±15%.
Leakage Current	Current passing through the varistor at the maximum allowable DC voltage and the standard test conditions*, called leakage current	MYZ-5H type varistor three parameter tester	Leakage current within the specified rating(μA).
Maximum allowable AC Voltage	Maximum a.c. r.m.s voltage of a substantially sinusoidal waveform which can be applied to the component is called Maximum allowable voltage.	Maximum Continuous AC Voltage 0.63 multiple varistor voltage	Actual continuous AC voltage 0.45 multiple varistor voltage.
composite waveform of Pulse Current (Open circuit having pulse shape of 1.2/50 uS for voltage and short circuit having 8/20 uS for current) 6KV/3KA		Maximum Continuous AC Voltage 0.63 multiple varistor voltage	After pulsing with stipulated times no appearance damage Clamping voltage change rate is ≤ ±10%
Clamping Voltage	The peak voltage developed across the varistor terminations under standard atmospheric conditions, when passing an 8/20 class current pulse. The peak value of two terminations is called clamping voltage.	8/20 μS T1=8uS+/-10% T2=20uS+/-10% 10/1000 μS T1=10 ^{+100%} μS T2=1000 ± 20% μS Impulse generator Storage oscilloscope	Clamping voltage less than the rated value, all specifications' peak current and clamping voltage see struction.

*标准测试条件: 温度15℃-35℃, 相对湿度45%-75%, 气压86 k Pa ~106k Pa。

*Standard test condition Temperature: 15℃-35℃; Relative humidity: 45%-75%; Air pressure: 86 Pa~106kPa.

1.2 HEL压敏电阻技术术语 HEL VARISTOR TECHNICAL TERM

项目	标准术语	测试设备	要求
能量耐受 2ms波形	<p>施加给压敏电阻矩形波2000 μ S或波形为10/1000 μ S的浪涌脉冲电流,使压敏电压变化率在±10%以内的最大能量。 能量(J)=k·I_p·V_c·10⁻⁶ k-对于2000 μ S, k=2000; 对于10/1000 μ S k=1391; I_p-电流峰值; V_c-电流通过时压敏电阻两端的电压峰值。</p>  <p>2ms矩形波波形图示</p>	<p>2000 μ S方波: T_D=2000 ± 10% μ S T_T ≤ 3000 μ S</p> <p>脉冲发生器 记忆示波器 MYZ-5H型压敏电阻三参数测试仪</p>	<p>施加本说明书规定的最大冲击能量后: 压敏电阻无外观损伤; 压敏电压变化率 ≤ ± 10%。</p>
通流容量	<p>施加给压敏电阻波形为8/20 μ S的脉冲电流,使压敏电压变化率在±10%以内的最大电流峰值。</p>	<p>脉冲发生器 记忆示波器 MYZ-5H型压敏电阻三参数测试仪</p>	<p>施加本说明书规定的最大脉冲电流后: 压敏电压变化率 ≤ ± 10%。</p>
电压温度系数	<p>压敏电阻温度从25℃到85℃时压敏电压的变化率,用%/℃表示。 $\frac{V_{1mA}(85^{\circ}C) - V_{1mA}(25^{\circ}C)}{V_{1mA}(25^{\circ}C)} \times \frac{1}{60} \times 100\%$</p>	<p>THS-A5P-150恒温恒湿箱, 压敏电阻测试仪</p>	<p>≤ -0.05 %/℃。</p>
静态功率	<p>在25℃ ± 1℃的环境温度下的最大功耗。</p>		<p>各规格静态功率见本说明书。</p>
电容量	<p>使用1kHz,电平 ≤ 1Vrms的电信号,测得压敏电阻的电容量。</p>	<p>CY 2646A型容量测试仪</p>	<p>电容量仅供参考,各规格电容量见本说明书。</p>

Item	Standard Terminology	Test equipment	Requirements
Pulse currents	<p>The maximum energy within the varistor voltage change of ± 10% when one impulse of 2000uS rectangular wave or 10/1000 μ S surge pulse current is applied. Energy (J)=K·I_p· V_c·10⁻⁶ For the 2000 μ S, K=2000; For the 10/1000 μ S, K=1391; I_p-Peak value of current when 2000 μ S or 10/1000 μ S wave form V_c-Peak value of voltage when the current of 2000 μ S or 10/1000 μ S developed across the varistor Current</p>  <p>2ms Rectangle wave</p>	<p>2000 μ S rectangular wave: T_D=2000 ± 10% μ S T_T ≤ 3000 μ S</p> <p>Impulse generator Storage oscilloscope MYZ-5H type varistor three parameter tester</p>	<p>After applied the maximum impact energy in this instruction: no appearance damage; varistor voltage change rate ≤ ± 10%</p>
Withstanding surge current	<p>The maximum peak current within the varistor voltage change of ± 10% with the standard impulse current (8/20 μ S) applied one time.</p>	<p>Impulse generator Storage oscilloscope MYZ-5H type varistor three parameter tester</p>	<p>After applied the maximum pulse current in this instruction: varistor voltage change rate ≤ ± 10%</p>
Varistor voltage Temperature Coefficient	<p>The varistor voltage change rate of varistor at temperature from 25 °C to 85 °C, showed as %/°C. $\frac{V_{1mA}(85^{\circ}C) - V_{1mA}(25^{\circ}C)}{V_{1mA}(25^{\circ}C)} \times \frac{1}{60} \times 100\%$</p>	<p>THS-A5P-150 constant temperature humidity chamber Varistor tester</p>	<p>≤ -0.05 %/°C.</p>
Rated wattage	<p>The maximum allowable power dissipation under the ambient temperature of 25℃ ± 1℃</p>		<p>The rated wattage of all specifications see instruction.</p>
Capacitance	<p>Typical capacitance measured at less than 1Vrms and frequency of 1kHz</p>	<p>CY 2646A capacity tester</p>	<p>Capacitance for reference only, all specifications' capacitance see instruction.</p>

2 HEL压敏电阻工艺性能、机械性能 HEL VARISTOR TECHNOLOGICAL & MECHANICAL CHARACTERISTICS

项目	试验方法	测试设备	要求
可焊性	<p>将压敏电阻导线浸入265℃ ± 5℃的焊锡液中2 ± 0.5s取出, 观察外观。</p>	<p>锡炉</p>	<p>引出端均匀上锡, 有90%以上浸锡面积, 缺陷不得集中在一处。</p>
耐焊接热	<p>将压敏电阻导线浸入350℃ ± 10℃的焊锡液中, 浸入深度距基座平面2-0.5mm, 采用1.5 ± 0.2mm的隔热层, 并维持5 ± 0.5s。恢复时间1小时以上2小时以下测量压敏电压。</p>	<p>锡炉</p>	<p>压敏电压变化率 ≤ ± 5%。</p>
标志抗溶剂性	<p>用棉球沾少许规定的溶剂(如酒精), 轻轻单方向擦拭标志两次, 观察外观。</p>	<p>棉球、酒精</p>	<p>标志清晰</p>
元件耐溶剂性	<p>将压敏电阻本体完全浸入规定的溶剂中(70 ± 5%F113与30 ± 5%的异丙醇混合物, 溶剂温度23 ± 5℃), 5 ± 0.5分钟后取出, 不擦拭, 在常温下恢复4小时, 观察外观, 测量压敏电压。</p>	<p>MYZ-5H型压敏电阻三参数测试仪</p>	<p>无可见损伤, 标志清晰; 压敏电压变化率 ≤ ± 5%。</p>
引出端强度	<p>压敏电阻其中一个引出端上施加下述荷重10秒钟: 引线直径(mm):0.6、0.8、1.0 荷重(N):10、10、20, 弯曲另一个引出端90度, 复原并反向90度, 复原。观察外观, 测量压敏电压。</p>	<p>MYZ-5H型压敏电阻三参数测试仪</p>	<p>无可见机械损伤; 压敏电压变化率 ≤ ± 5%。</p>
振动	<p>将压敏电阻固定在振动台上, 加速度98m/s², 使用10Hz到55Hz频率, 振幅0.75mm, 持续6小时后观测外观, 测试压敏电压及漏电流。</p>	<p>振动台</p>	<p>无可见机械损伤; 压敏电压变化率 ≤ ± 5%; 漏电流在规定的额定值内。</p>
碰撞	<p>将压敏电阻固定在碰撞台上, 以加速度390m/s², 碰撞4000 ± 10次, 然后观察外观, 测试压敏电压及漏电流。</p>	<p>碰撞台</p>	<p>无可见机械损伤; 压敏电压变化率 ≤ ± 5%; 漏电流在规定的额定值内。</p>

Item	Standard Terminology	Test equipment	Requirements
Solderability	<p>Dipping the varistor's terminals to a soldering bath at temperature 265℃ ± 5℃ for 2 ± 0.5seconds, visual observation.</p>	<p>Solder machine</p>	<p>Above 90% of the terminals shall be covered with solder uniformly.</p>
Resistance to Soldering heat	<p>After each lead shall be dipped into a solder bath having a temperature 350℃ ± 10℃, to a point 2.0-0.5mm from the body of the unit. Using shielding Board(t=1.5 ± 0.2mm), be held there for 5 ± 0.5s, and stored at room temperature and humidity for 1 to 2 hours, then measure the varistor voltage</p>	<p>Solder machine</p>	<p>Varistor voltage change rate ≤ ± 5%.</p>
Solvent resistance of marking	<p>Solvent: alcohol Rubbing material: cotton wool Gently wipe the marking twice in one direction, thereafter, visual examination.</p>	<p>Cotton wool Alcohol lamp</p>	<p>Legible marking.</p>
Component Solvent resistance	<p>Solvent:70 ± 5% and F113+30 ± 5% strang third mellow mixture, Solvent temperature:23 ± 5℃, 5 ± 0.5Min. Recovery:4hours. Thereafter, visual examination and measure the varistor.</p>	<p>MYZ-5H type varistor three parameter tester</p>	<p>No visible damage Legible marking Varistor voltage change rate ≤ ± 5%.</p>
Robustness of Terminations	<p>After gradually applying the force specified below and keeping the unit fixed for ten seconds. Lead diameter(mm):0.6\0.8\1.0 Force(N):10\10\20 Bending the other terminal for 90°, recovery and reverse 90°. Visual examination, measure varistor voltage.</p>	<p>MYZ-5H type varistor three parameter tester</p>	<p>No visible damage Varistor voltage change rate ≤ ± 5%.</p>
Vibration	<p>Fixing the varistor at vibrating table: Acceleration: 98 m/s² Frequency:10Hz-55Hz Amplitude: 0.75mm Total duration: 6 hours Thereafter, visual examination and measure varistor voltage and leakage current.</p>	<p>Vibrating table</p>	<p>No visible damage. Varistor voltage change rate ≤ ± 5%. Leakage current within the rated value.</p>
Shock(or bump)	<p>Fixing the varistor at collision sets:Acceleration:490 m/s² Number of bump: 4000 ± 10 times, Thereafter, visual examination and measure varistor voltage and leakage current.</p>	<p>Collision sets</p>	<p>No visible damage. Varistor voltage change rate ≤ ± 5%. Leakage current within the rated value.</p>

3.1

压敏电阻安全可靠性能、环境可靠性试验

HEL VARISTORS SECURITY AND ENVIRONMENTAL TEST

项目	试验方法	测试设备	要求																														
阻燃性	将压敏电阻固定好后施加规定的火焰到压敏电阻的侧面，施加时间15s循环3次。	酒精灯	第1、2次循环在15s内自熄 第3次循环在30s内自熄。																														
脉冲电流寿命	在常温下给压敏电阻施加下表规定的8/20μ脉冲电流,以10s为间隔连续冲击10000次后,在常温下放置1小时以上、2小时以内测量压敏电压。 <table border="1" style="display: inline-table; margin-right: 20px;"> <tr><td>5D</td><td>18v-68v</td><td>5A</td></tr> <tr><td></td><td>82v-680v</td><td>20A</td></tr> </table> <table border="1" style="display: inline-table; margin-right: 20px;"> <tr><td>7D</td><td>18v-68v</td><td>15A</td></tr> <tr><td></td><td>82v-820v</td><td>50A</td></tr> </table> <table border="1" style="display: inline-table; margin-right: 20px;"> <tr><td>10D</td><td>18v-68v</td><td>50A</td></tr> <tr><td></td><td>82v-1800v</td><td>100A</td></tr> </table> <table border="1" style="display: inline-table; margin-right: 20px;"> <tr><td>14D</td><td>18v-68v</td><td>75A</td></tr> <tr><td></td><td>82v-1800v</td><td>150A</td></tr> </table> <table border="1" style="display: inline-table;"> <tr><td>20D</td><td>18v-68v</td><td>100A</td></tr> <tr><td></td><td>82v-1800v</td><td>200A</td></tr> </table>	5D	18v-68v	5A		82v-680v	20A	7D	18v-68v	15A		82v-820v	50A	10D	18v-68v	50A		82v-1800v	100A	14D	18v-68v	75A		82v-1800v	150A	20D	18v-68v	100A		82v-1800v	200A	脉冲发生器 MYZ-5H型压敏电阻三参数测试仪	外观无损伤; 压敏电压变化率 $\leq \pm 10\%$ 。
5D	18v-68v	5A																															
	82v-680v	20A																															
7D	18v-68v	15A																															
	82v-820v	50A																															
10D	18v-68v	50A																															
	82v-1800v	100A																															
14D	18v-68v	75A																															
	82v-1800v	150A																															
20D	18v-68v	100A																															
	82v-1800v	200A																															
快速温度变化	将压敏电阻进行如下温度循环取出后,在常温下放置1小时以上、24小时以内测量压敏电压。 <table border="1" style="display: inline-table; margin-right: 20px;"> <tr><th>顺序</th><th>温度</th><th>时间</th></tr> <tr><td>1</td><td>-40±3℃</td><td>30 Min</td></tr> <tr><td>2</td><td>常温</td><td><3 Min</td></tr> </table> <table border="1" style="display: inline-table; margin-right: 20px;"> <tr><th>顺序</th><th>温度</th><th>时间</th></tr> <tr><td>3</td><td>+85±2℃</td><td>30 Min</td></tr> <tr><td>4</td><td>常温</td><td><3 Min</td></tr> </table> 5个循环 顺序3,或+125+/-2℃	顺序	温度	时间	1	-40±3℃	30 Min	2	常温	<3 Min	顺序	温度	时间	3	+85±2℃	30 Min	4	常温	<3 Min	HLA型高低温循环试验箱 MYZ-5H型压敏电阻三参数测试仪	外观无损伤; 标志清晰; 压敏电压变化率 $\leq \pm 5\%$ 。												
顺序	温度	时间																															
1	-40±3℃	30 Min																															
2	常温	<3 Min																															
顺序	温度	时间																															
3	+85±2℃	30 Min																															
4	常温	<3 Min																															
耐热性	将压敏电阻放置在125℃±2℃环境中1000小时,取出后在常温下放置1小时以上、4小时以内测量压敏电压和漏电流。	101-II A型鼓风烤箱 MYZ-5H型压敏电阻三参数测试仪	外观无损伤; 压敏电压变化率 $\leq \pm 5\%$; 漏电流在规定的额定值内。																														

Item	Standard Terminology	Test equipment	Requirements																														
Flame retardant	Impose the required flame on the side of varistor after fixed the varistor, 15s per cycle for 3 cycles.	Alcohol Lamp	Self-extinguishing within 15s for first and second cycles, self-extinguishing within 30s for 3rd cycle.																														
Virtual total duration of a pulse current	The varistor voltage shall be measured after the 8/20uS impulse listed below is applied 10,000 times continuously with the interval of 10s at room temperature and lay for 1 to 2 hours. <table border="1" style="display: inline-table; margin-right: 20px;"> <tr><td>5D</td><td>18v-68v</td><td>5A</td></tr> <tr><td></td><td>82v-680v</td><td>20A</td></tr> </table> <table border="1" style="display: inline-table; margin-right: 20px;"> <tr><td>7D</td><td>18v-68v</td><td>15A</td></tr> <tr><td></td><td>82v-820v</td><td>50A</td></tr> </table> <table border="1" style="display: inline-table; margin-right: 20px;"> <tr><td>10D</td><td>18v-68v</td><td>50A</td></tr> <tr><td></td><td>82v-1800v</td><td>100A</td></tr> </table> <table border="1" style="display: inline-table; margin-right: 20px;"> <tr><td>14D</td><td>18v-68v</td><td>75A</td></tr> <tr><td></td><td>82v-1800v</td><td>150A</td></tr> </table> <table border="1" style="display: inline-table;"> <tr><td>20D</td><td>18v-68v</td><td>100A</td></tr> <tr><td></td><td>82v-1800v</td><td>200A</td></tr> </table>	5D	18v-68v	5A		82v-680v	20A	7D	18v-68v	15A		82v-820v	50A	10D	18v-68v	50A		82v-1800v	100A	14D	18v-68v	75A		82v-1800v	150A	20D	18v-68v	100A		82v-1800v	200A	Impulse generator MYZ-5H type varistor three parameter tester	No damage Varistor voltage change rate $\leq \pm 10\%$.
5D	18v-68v	5A																															
	82v-680v	20A																															
7D	18v-68v	15A																															
	82v-820v	50A																															
10D	18v-68v	50A																															
	82v-1800v	100A																															
14D	18v-68v	75A																															
	82v-1800v	150A																															
20D	18v-68v	100A																															
	82v-1800v	200A																															
Rapid change of temperature	Condition the specimen to each temperature from step 1 to step 4 in this order for the period shown in the table of specifications. The change of Varistor voltage and mechanical damage shall be examined within 1hour to 24 hours <table border="1" style="display: inline-table; margin-right: 20px;"> <tr><th>Step</th><th>Temperature</th><th>Period</th></tr> <tr><td>1</td><td>-40±3℃</td><td>30 Min</td></tr> <tr><td>2</td><td>Room Temp.</td><td><3 Min</td></tr> </table> <table border="1" style="display: inline-table; margin-right: 20px;"> <tr><th>Step</th><th>Temperature</th><th>Period</th></tr> <tr><td>3</td><td>+85±2℃</td><td>30 Min</td></tr> <tr><td>4</td><td>Room Temp.</td><td><3 Min</td></tr> </table> 5 Cycles Order 3, or +125 +/- 2℃	Step	Temperature	Period	1	-40±3℃	30 Min	2	Room Temp.	<3 Min	Step	Temperature	Period	3	+85±2℃	30 Min	4	Room Temp.	<3 Min	HLA type High-Low temperature chamber MYZ-5H type varistor three parameter tester	No damage Legible marking Varistor voltage change rate $\leq \pm 5\%$.												
Step	Temperature	Period																															
1	-40±3℃	30 Min																															
2	Room Temp.	<3 Min																															
Step	Temperature	Period																															
3	+85±2℃	30 Min																															
4	Room Temp.	<3 Min																															
Heat resistance	The varistor shall be subjected to 125℃±2℃ for 1000 hours and then stored at room temperature for 1 hour to 4 hours, measure the varistor voltage and leakage current.	101-II A drum wind oven MYZ-5H type varistor three parameter tester	No damage. Varistor voltage change rate $\leq \pm 5\%$. Leakage current within the rated value.																														

3.2

压敏电阻安全可靠性能、环境可靠性试验

HEL VARISTORS SECURITY AND ENVIRONMENTAL TEST

项目	试验方法	测试设备	要求
耐寒性	将压敏电阻放置在-40℃±2℃环境中1000小时,取出后在常温下放置1小时以上,4小时以内测量压敏电压和漏电流。	THS-A5P-150 恒温恒湿箱 MYZ-5H型压敏电阻三参数测试仪	外观无损伤; 压敏电压变化率 $\leq \pm 5\%$; 漏电流在规定的额定值内。
耐湿性	将压敏电阻放置在40℃±2℃、相对湿度90%~95%环境中21天,取出后在常温下放置1小时以上、4小时以内测量压敏电压和漏电流。	THS-A5P-150 恒温恒湿箱 MYZ-5H型压敏电阻三参数测试仪	外观无损伤; 压敏电压变化率 $\leq \pm 10\%$; 漏电流在规定的额定值内。
耐湿负荷	将压敏电阻放置在40℃±2℃、相对湿度90%~95%环境中21天,并施加最大允许使用直流电压的10%,取出后在常温下放置1小时以上,4小时以内测量压敏电压和漏电流。	THS-A5P-150 恒温恒湿箱 ADCS交直流寿命试验机 MYZ-5H型压敏电阻三参数测试仪	外观无损伤; 压敏电压变化率 $\leq \pm 10\%$; 漏电流在规定的额定值内。
高温负荷	将压敏电阻放置在85℃±2℃或125℃环境中1000小时,并施加该温度相应的最大允许使用电压,通电90分钟,断电30分钟,取出后在常温下放置1小时以上、4小时以内测量压敏电压和限制电压。	101-II A型鼓风烤箱 ADCS交直流寿命试验机 MYZ-5H型压敏电阻三参数测试仪	外观无损伤; 压敏电压变化率 $\leq \pm 10\%$; 限制电压变化率 $\leq \pm 20\%$ 。
气候顺序	干热: +85℃±2℃, 16小时; (+125℃+/-2℃) 循环湿热: IEC68-2-30试验Db, 55℃, 一个循环24小时; 寒冷: -40℃±3℃, 2小时; 循环湿热: IEC68-2-30试验Db其余循环。 取出后在常温下放置1小时以上、24小时以内测量压敏电压。	HLA型高低温循环试验箱 MYZ-5H型压敏电阻三参数测试仪	外观无损伤; 标志清晰; 压敏电压变化率 $\leq \pm 5\%$ 。

Item	Standard Terminology	Test equipment	Requirements
Cold resistance	The varistor shall be subjected to -40℃±2℃ for 1000 hours and then stored at room temperature for 1 hour to 4 hours, measure the varistor voltage and leakage current.	THS-A5P-150 Constant temperature humidity chamber MYZ-5H type varistor three parameter tester	No damage. Varistor voltage change rate $\leq \pm 5\%$. Leakage current within the rated value.
Damp Heat/Humidity	The varistor shall be subjected to 40℃±2℃, 90 to 95% RH for 21 days and then stored at room temperature for 1 to 4 hours, measure the varistor voltage and leakage current within the rated value.	THS-A5P-150 Constant temperature humidity chamber MYZ-5H type varistor three parameter tester	No damage. Varistor voltage change rate $\leq \pm 10\%$.
Damp heat load/humidity load	The varistor shall be subjected to 40℃±2℃, 90 to 95% RH and 10% Maximum allowable DC voltage for 21 days and then stored at room temperature for 1 to 4 hours, measure the varistor voltage and leakage current within the rated value.	THS-A5P-150 Constant temperature humidity chamber ADCS ac/dc life testing machine MYZ-5H type varistor three parameter tester	No damage. Varistor voltage change rate $\leq \pm 10\%$.
High temperature load	The varistor shall be subjected to 85℃±2℃ or 125℃ and Maximum allowable AC voltage for 1000 hours, power of 90 minutes, power outage of 30 minutes, and then stored at room temperature for 1 hour to 4 hours, measure the varistor voltage and leakage current.	101-IIA drum wind oven ADCS ac/dc life testing machine MYZ-5H type varistor three parameter tester	No damage. Varistor voltage change rate $\leq \pm 10\%$ Limiting voltage change rate $\leq \pm 20\%$.
Category temperature range	Dry heat: +85℃±2℃, 16hours; (+125℃+/-2℃) Damp heat, cyclic: IEC68-2-30 Test Db, 55℃, One cycle 24 hours; Cold: -40℃±3℃, 2 hours; (Low air pressure test not applicable) Damp heat, cyclic: IEC68-2-30 Test Db, remaining cycles. Then stored at room temperature for 1 to 24 hour, measure the varistor voltage	HLA high-low temperature circulation chamber MYZ-5H type varistor three parameter tester	No damage Legible marking Varistor voltage change rate $\leq \pm 5\%$.



注意事项

压敏电阻器应在其额定参数条件以内工作，否则有可能因外围异常条件导致压敏电阻发热、劣化、直至击穿、燃烧。压敏电阻器做为跨接元件其失效模式主要为短路。因此，在使用前要充分理解相关技术条件。

请仔细阅读以下内容，如有任何疑问，请与我们联系。

1. 严格遵守以下原则,避免不可预期事故发生

- 1) 压敏电阻器的工作环境温度应该在规定范围内。HEL压敏电阻上限类别温度为85℃或125℃。建议灯具等易发热类电器，选用T型125℃ HEL压敏电阻。
- 2) 压敏电阻器的工作电压不能超出规格表中最大允许使用电压值，并注意温度降额曲线图。
- 3) 通过压敏电阻器的浪涌电流不应超出规格表中最大峰值电流，在浪涌脉冲重复产生的场合，通过压敏电阻器的浪涌峰值电流和能量不应超出脉冲寿命规定值(参见降额曲线图:波峰宽度-电流峰值-冲击次数三者关系)。
- 4) 当浪涌脉冲以很短的间歇重复施加于压敏电阻器时，设计师应计算此时的平均功率并应该使其低于规格表中静态功率。否则压敏电阻累积热量越来越多，导致热崩溃失效。
- 5) 电网环境要求：压敏电阻在设备中所处供电环境，如电网电压稳定性，周围是否有大型用电设备，特别是建筑物和低压配电变压器是否有良好的接地等，对压敏电阻影响极大。

2. 保护措施

1、对压敏电阻器加装保险装置,可免除由外界不确定因素对压敏电阻器和装置造成的不利后果。

1.1 压敏电阻器接在电源线之间时，必须在火线进线处串联一保险丝(见图一)

1.2 压敏电阻器接在火线与大地之间时，由于存在接地电阻,出现故障时电流型保险丝有可能不被熔断，导致压敏电阻器未被保护。改进措施：
A. 在进线中接入漏电开关,当电路中出现漏电流时,及时切断电路。
B. 紧贴压敏电阻器安装热熔断器,串联在回路中,当压敏电阻器过热时，热熔断器断开,切断电路。

图一

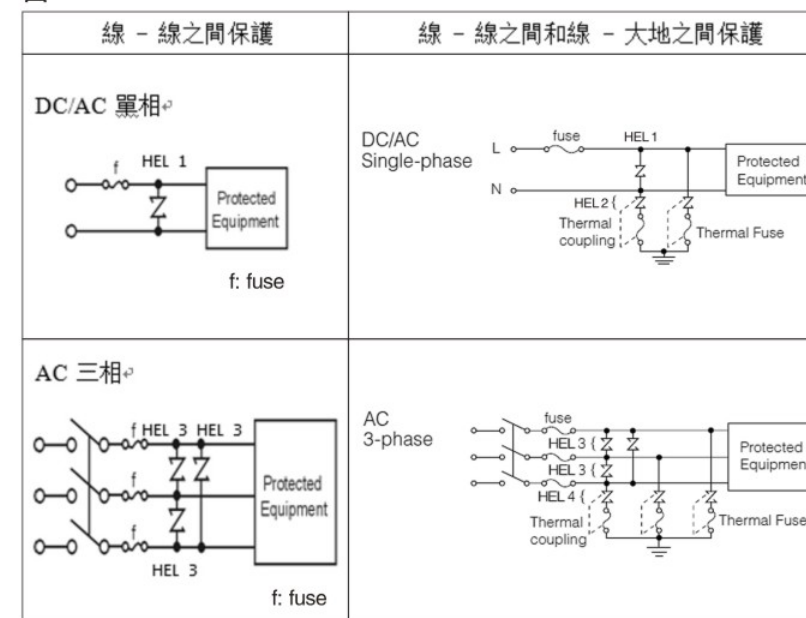

2、保险安装如图一，对应不同系列的压敏电阻，推荐下列规格的保险丝：

压敏电阻器系列	5D	7D	10D	14D	20D
推荐保险丝规格	1~2A	2~3A	3~5A	3~10A	5~15A

3. 压敏电阻器规格型号选定

- 1) 在实际电路中的最大工作电压,必须低于规格表中最大工作电压。
- 2) 要充分考虑到电网(或电路)工作电压的波动幅度，特别是要考虑在工频电网中，由于各相负荷不平衡，火线与零线瞬时短路,容性(或感性)负荷中的开关操作引起的LC共振导致电压瞬间波动的因素，选取压敏电阻器压敏电压时，要留有余量。
- 3) 线-线保护(见图一)：在工频电网中进行线-线之间保护时，针对各档电压推荐的压敏电阻器的压敏电压值如表一。
- 4) 线-大地之间保护(见图一)：在工频电网中进行火线与大地之间保护时，针对各档电压推荐的压敏电阻器的压敏电压如表二。

表一 线-线之间

HEL	工作电压	型号规格
HEL1	AC100V	HEL□D201 to □D361
	AC120V	HEL□D241 to □D431
HEL3	AC200V	HEL□D471 to □D621
	AC240V	HEL□D511 to □D681
	AC380V	HEL□D821 to □D102

表二 线-大地之间

HEL	工作电压	型号规格
HEL2 HEL4	AC100V AC220V	HEL□D471 HEL□D511 HEL□D621 HEL□D821 HEL□D182
	AC230V AC240V	HEL□D511 HEL□D621 HEL□D821 HEL□D182
	AC380V	HEL□D112 HEL□D182

- 5) 压敏电阻直径大小的选择，则要考虑被保护设备所处环境的雷电浪涌大小，设备绝缘耐压水平，设备功率大小，安全要求等级等因素而定。

4. 设计装配注意事项

- 1) 压敏电阻器的环境温度不能超出技术条件规定的范围，也不要靠近设备中的发热组件。
- 2) 若将压敏电阻与其它组件罐封在一起，由于压敏电阻环境温度较高，建议选用高温T型压敏电阻。
- 3) 不要用丙酮等溶剂清洗压敏电阻器，以免破坏包封层环氧树脂。
- 4) 安装时应避免敲击，弯折压敏电阻器，以免造成机械损伤。
- 5) 如发现压敏电阻外观有损伤，请更换。

5. 压敏电阻器的固有电容

压敏电阻器的固有电容最大值已在规格表中列出，供设计师在高频电路中选择时参考。

6. 不适宜环境条件

- 1) 压敏电阻器不应暴露在露天工作，不要被阳光直接照射。
- 2) 压敏电阻器应避免在雨、水蒸气等高温高湿的条件下工作。
- 3) 压敏电阻器应避免在沙尘、盐雾、有害气体的条件下工作。

7. 长期存放

- 1) 压敏电阻不能在高温高湿的条件下存放，应在温度40℃以下，相对湿度75%RH以下的室内存放，存放期不应超过1年。存放超过1年的压敏电阻使用前要进行重新检测。
- 2) 压敏电阻器和腐蚀性气体在一起存放。
- 3) 存放在库房的压敏电阻器不要被阳光直射。

8. 焊接温度 - 时间的推荐(见图二)

类别	焊接方法	焊接温度	焊接时间	备注
D-Type	波峰焊	260℃	10秒 max	5D系列要在5秒以内
	回流焊	——	——	D-Type不可回流焊

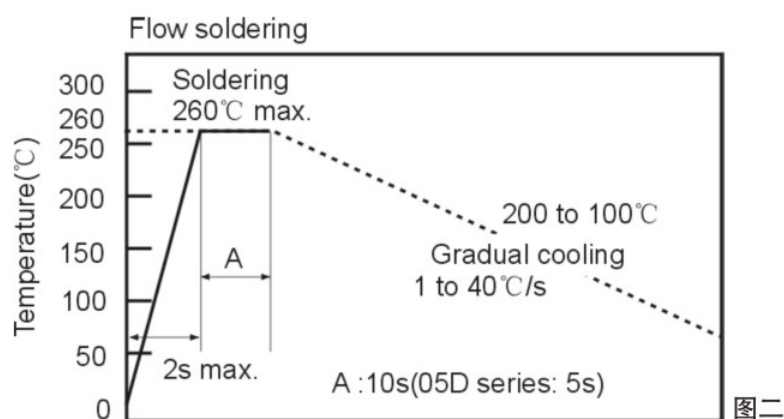
**9. 其它**

- 1) 请在规定条件下使用，如有超出规定条件使用的情况，如使用环境温度较高，我司可协助设计解决方案。
- 2) 如有不详或建议之处，请及时与我们联系，我们将提供解答说明。

PRECAUTIONS FOR HANDLING

THE "HEL" TRANSIENT/SURGE ABSORBERS (HEREAFTER REFERRED TO AS "THE HEL VARISTOR") MAY FAIL IN A SHORT-CIRCUIT MODE OR IN AN OPEN-CIRCUIT MODE, WHEN SUBJECTED TO SEVERE CONDITION OF ELECTRICAL, ENVIRONMENTAL AND/OR MECHANICAL STRESSES BEYOND THEIR SPECIFIED "RATING" AND SPECIFIED "CONDITIONS", RESULTING IN BURNOUT, FLAMING OR GLOWING IN THE WORST CASE.

FOLLOWING "PRECAUTIONS FOR SAFETY" AND "APPLICATION NOTES" SHALL BE TAKEN IN YOUR MAJOR CONSIDERATION. IF YOU HAVE A QUESTION ABOUT THE "PRECAUTIONS FOR HANDLING", PLEASE CONTACT OUR ENGINEERING SECTION OR FACTORY.

1. STRICTLY ABIDE BY THE FOLLOWING PRINCIPLES TO AVOID UNEXPECTED ACCIDENTS**1.1 Operating conditions**

- 1) The HEL varistors shall not be operated beyond the specified "working conditions temperature" in the specifications. The upper limit temperature of the varistor is 85°C or 125°C. For easy heating devices such as lights HEL varistor T type 125°C is recommended.
- 2) The HEL varistors shall not be operated beyond the specified "Maximum allowable voltage" in the specifications. Pay attention to Temperature Derating Curves.
- 3) The HEL varistors shall not be subjected to surge currents beyond the "Maximum allowable voltage" in the specifications. In case of application to repeated surge/overvoltage, the HEL varistors shall not be subjected to surge currents and energy levels above the specified maximum rating in "impulse life rating" in the specifications. (refer to derating curves: the relationship between peak wave width, peak current value and pulse times)
- 4) When surge/overvoltage is intermittently applied to the HEL varistors with short durations, the devices shall not be operated beyond the specified "Rated Wattage" in the specifications. Otherwise, the varistors accumulate more and more heat would lead to thermal breakdown.
- 5) Power grid environmental requirements: the HEL varistors shall be impacted greatly by the electricity supply environment to the equipment including voltage stability, large electrical equipment around, buildings and low voltage distribution transformer well-grounded etc.

2. PROTECTION COUNTERMEASURES

- 2.1 When the HEL varistor are applied to between a live part and a metallic chassis of equipment, following safety countermeasures shall be taken to protect human from electric shock.
 - A) The metallic chassis shall be earthed to the ground
 - B) The live part shall be equipped with a protective cover for preventing electric shock.

3. APPLICATION NOTES

3.1 Protective devices for varistors

3.1.1 The HEL Varistors shall be protected from serious accidents due to unexpected physical phenomenon by following safety countermeasures

In case of "Across-the line use", The HEL varistor shall be protected by connecting a ground fault circuit interrupter of fusing in series to the devices. (See table 1)

In case of "line to ground use", the short-circuit of the varistor may not blow the current type fuse due to the grounding resistance (between line and ground). Which may cause flaming or burnout of the devices in the worst case.

Following safety countermeasures(AorB) are recommended:

A) Connecting a "leakage current circuit breaker" in series to the varistor to be protected. (see table 1)

B) Use current type fuses and thermal type fuse which are thermally coupled each others. (See table 1)

3.2 Circuit Design 1

3.2.1 General precautions

In selection of varistor voltage ratings for line protection, following general precautions shall be taken in your consideration:

- (1) Maximum operating voltage shall be lower than the specified "maximum allowable voltage" of the varistor applied.
- (2) some reasonable margin is required against fluctuation of the primary AC line voltage where the varistor is applied for preventing mechanical and/or electrical failures of the device.

3.2.2 Across-the-line use (line to line surge protection)

Select the HEL varistors recommended in table 2.

Notes: because the primary line voltage temporarily rises due to load unbalance of separately wired loads, short circuit between the live line and the neutral line or LC response at swiching for a capaitive load, HEL varistor with * are recommended for AC120V or 240V applications. (see table 2)

3.2.3 Line to Ground use (line to ground surge protection) Select the HEL varistor recommended in table 3.

Notes: when 500V insulation resistance test of the circuits employing HEL varistor is conducted. The HEL varistor shall be removed after getting approval from the customer or the HEL varistor **with maximum allowable voltage exceeding to the test voltage shall be applied. (see table 3)

When AC1000V or 1200V dielectric with standing test is conducted, HEL varistors shall be removed after getting approval from the customers according to the relevant regulations, or HEL varistor *** with the maximum allowable voltage exceeding to the test voltage shall be applied. (see table 3)

Table 1

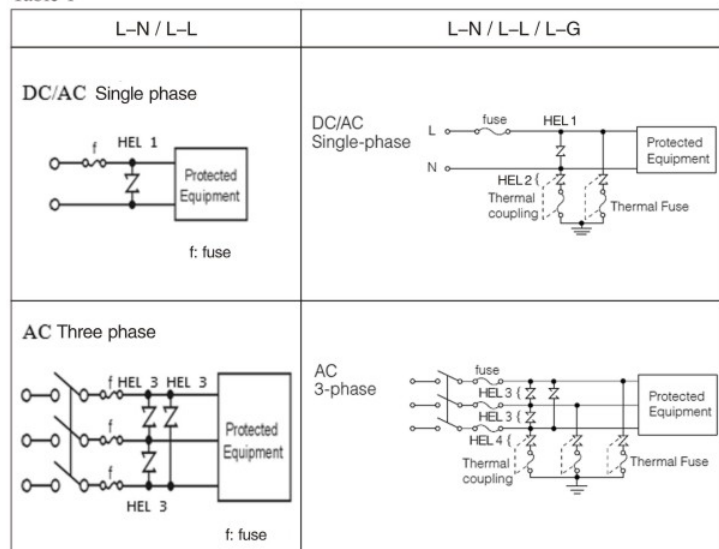

HEL	Nominal Line Voltage	Part Number of HEL
HEL1	AC100V	HEL□D201 to □D361*
	AC120V	HEL□D241 to □D431*
HEL3	AC200V	HEL□D471 to □D621*
	AC240V	HEL□D511 to □D681*
	AC380V	HEL□D821 to □102

HEL	Nominal Line Voltage	Part Number of HEL
HEL2 HEL4	AC100V AC220V	HEL□D471 HEL□D511 HEL□D621* HEL□D821** HEL□D182***
	AC230V AC240V	HEL□D511 HEL□D621* HEL□D821** HEL□D182***
	AC380V	HEL□D112** HEL□D182**

3.3 Circuit design 3 (fusing varistors)

3.3.1 Fusing the HEL varistors

For varistor protection it is recommended to select suitable fuses in table 4

Part No.	HEL-5D□□□	HEL-7D□□□	HEL-10D□□□	HEL-14D□□□	HEL-20D□□□
Recommended Fuse Ratings	1~2A	2~3A	3~5A	3~10A	5~15A

3.3.2 When a line current of equipment is higher than the recommended rating of the fuse in table 2, the location of the fuse shall be arranged according to Fig 2.

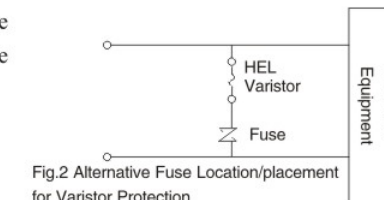

3.4 Environmental conditions

- (1) the HEL varistor shall not be exposed outdoors, because of being designed for indoors use.
- (2) The HEL varistor shall not be operated beyond the specified operating temperature range and shall not be exposed to direct sunlight and heating part of equipment.
- (3) The HEL varistor shall not be operated under severe conditions of high temperature and high humidities such as places exposed to rain, wind and vapor.
- (4) the HEL varistors shall be free from dust salty wind and atmosphere polluted by corrosive gas.
- (5) Grid environment and Lightning environment

The power supply environment of varistor in device. Such as voltage stability, the varistor' s safety are influenced by the large electric equipment around, especially the building and low voltage transformer have a poor grounding. Above poor grounding easily caused partial lightning string into the zero line, leading to the equipment counterattack, so varistor often damaged. The place with more lightning a year, the problem is more serious when thunderstorm season.

3.5 Precautions for assemblies and handlings

3.5.1 Solvent cleaning

Organic solvents such as thinner and acetone etc. shall not be applied to the HEL varistors for preventing deterioration of the external coating or molding resin

3.5.2 Abnormal mechanical stresses

Abnormal mechanical stresses beyond the specified values such as strong failing shocks, ribrations and bending/pulling forces, shall be kept minimum to prevent mechanical/electrical-failures of the devices.

3.5.3 Plastic molding

If another plastic molding is applied to the HEL varistors on you option, the influences on reliability of the HEL varistors shall be carefully investigated in you equipment.

3.5.4 Soldering conditions

In soldering of the HEL varistors, the soldering conditions shall conform to the each individual specification of the device for prevent mechanical/electrical failures.

3.6 Long term storage

- (1) The HEL varistors shall not be stored under severe conditions of high temperatures and high humidities. Store them indoors under 40°C max. and 75% RH max. Use them within one year. If stored beyond the limit, check the solderability before use.
- (2) The HEL varistors shall not be stored under corrosive atmospheres such as hydrogen sulfide, sulfurous acid, chlorine and ammonia.
- (3) The HEL varistors shall not be exposed to direct sunlight and shall not be stored under dew formation

3.7 Parallel capacitances of the HEL varistors.

The HEL varistors have relatively high capacitances specified in the individual specifications special consideration shall be taken into account in applications to high frequency transmission lines or circuits.

编带包装 TAPE & REEL PACKING



图1



图2

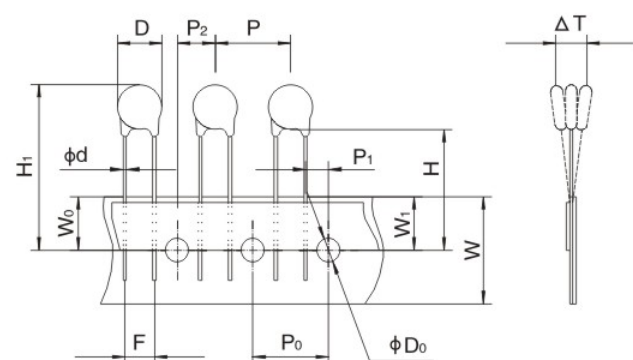

Symbol	5D	7D	10D	14D	20D
$P \pm 1$	12.7	12.7	15	25.4	30
$P_0 \pm 1$	12.7	12.7	15	12.7	15
$P_1 \pm 0.7$	3.85	3.85	5	8.95	11.25
$P_2 \pm 1.3$	6.35	6.35	7.5	12.7	12.7
$H \pm 1.0$	20	20	20	21	21
H_{1max}	29.0	32.0	32.0	36.0	40.0
$W \pm 1.0$	18	18	18	18	18
W_{0max}	10.0	10.0	10.0	8.0	8.0
$W_1 \pm 0.5$	9.0	9.0	9.0	9.0	9.0
$\Phi D_0 \pm 0.3$	4.0	4.0	4.0	4.0	4.0
D_{max}	7.5	9.0	9.0	13.5	17.0
$\Phi d \pm 0.1$	$\Phi 0.58$	$\Phi 0.58$	$\Phi 0.58$	$\Phi 0.78$	$\Phi 0.78$
$\Delta T \pm 2.0$	0.0	0.0	0.0	0.0	0.0
$t \pm 0.2$	0.6	0.6	0.6	0.6	0.6
$F \pm 1.0$	5.0	5.0	5.0	7.5	10.0
图示	图1			图2	

附录 APPENDIX

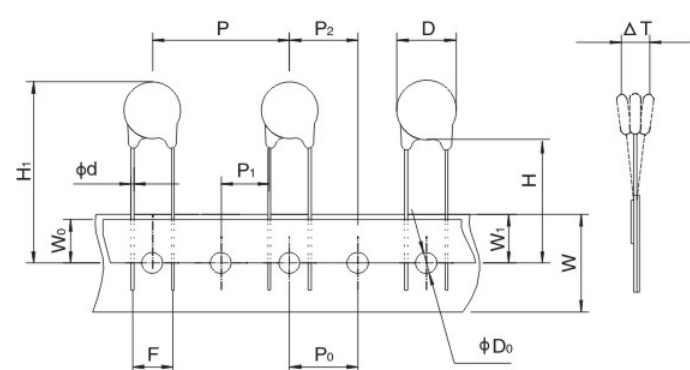
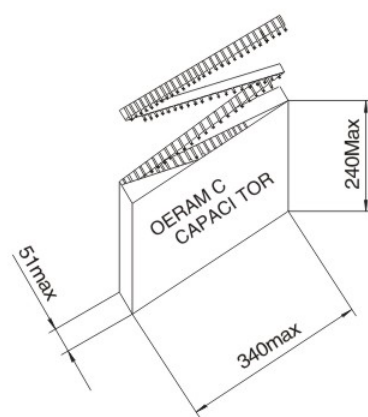
关于标准中浪涌冲击条款的简要说明

一. 氧化锌压敏电阻元件标准中关于浪涌冲击的标准

1) 国家标准、IEC标准

- ① GB/T10193《电子设备用压敏电阻器 第1部分：总规范》，等同采用IEC61051；
- ② GB/T10194《电子设备用压敏电阻器 第2部分：分规范 浪涌抑制型压敏电阻器》，等同采用IEC61051-2；
- ③ GB/T10195《电子设备用压敏电阻器 第2部分：空白详细规范 氧化锌浪涌抑制型压敏电阻器 评定水平E》，等同采用IEC61051-2-2。

以上标准被国际社会广泛采用，CQC和VDE认证均采用此标准。标准规定的浪涌冲击测试方法是：8/20 μs在一个方向冲击10次，间隔30秒。10/1000 μs和2ms在一个方向冲击10次，间隔2分钟。冲击后外观完好，压敏电压变化率小于10%判定合格。在实际生产检验时，依据降额曲线图，选用1次脉冲电流值（通流容量）。冲击电流值由厂家宣告。

VDE补充了测试项目，依据IEC60950-1 Annex Q，增加了6KV/3KA组合波测试，方法是：同方向10次冲击，间隔30秒。压敏电压变化率在10%内判定合格。

CQC 2012年也增加此项测试，依据GB4943.1-2011《信息技术设备 安全 第1部分：通用要求》及GB8898-2011《音频、视频及类似电子设备 安全要求》（IEC60065），测试方法同VDE一样。

2) UL1449标准第4版

标称放电电流 I_n 测试流程如下：

- ① 在未通电的情况下，按制造商宣告的8/20 μs I_n 电流冲击一次，并记录残压MLV；
- ② 在1秒钟内给样品加上最大允许使用AC电压持续60 ± 5秒；
- ③ 上述步骤①和②重复5次；
- ④ 步骤①②③结束后，完成1组冲击，每组冲击5次，样品休息30 ± 5分钟；
- ⑤ 上述步骤①②③④重复3次，完成3组冲击，即一个样品共冲击15次；
- ⑥ 15次测试结束，再给样品加上MCOV 15分钟，之后样品要完好无损。

要求15次每次残压值MLV均在15次平均值的10%之内，压敏电压变化率小于10%。

二. 电子设备整机和SPD保护器关于浪涌冲击的标准

1) GB/T17626.5《电磁兼容 试验和测量技术 浪涌（冲击）抗扰度试验》，等同采用IEC61000-4-5，适应电子设备整机的浪涌测试，规定用组合波冲击，开路电压波1.2/50 μs，短路为电流波8/20 μs，等级如下：

1级 0.5KV /0.25KA； 2级 1KV /0.5KA； 3级 2KV /1KA； 4级 4KV /2KA；

X级 为开放等级，可在样品要求中规定。

在加载工频电压情况下，施加组合波电压，分别在相位角0°、90°、180°、270°，正反两个方向各5次冲击，间隔60秒，共40次冲击。冲击后性能正常，元件外观完好判定合格。

这是电子设备整机的基础性标准，常被其它整机标准引用。

2) GB/T3482-2008《电子设备雷击试验方法》。

3) GB/T18802.1, IEC61643-1《低压电涌保护器 第1部分：低压配电系统的电涌保护器 性能要求和试验方法》。

因篇幅限制，这里只注明标准号和名称，供设计工程师查询参考。

HEL压敏电阻适用上述标准，详见P10。