

# GR2A THRU GR2M

## Fast Recovery Rectifier

### Features

- High efficiency
- High current capability
- High reliability
- High surge current capability
- Low power loss
- Glass passivated chip junction
- Solder dip 265 °C max. 10 s, per JESD 22-B106

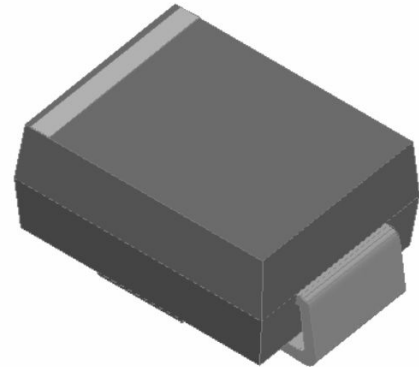

### Typical Applications

For use in general purpose rectification of power supplies, inverters, converters, and freewheeling diodes for consumer, and telecommunication.

### Mechanical Data

- Package:SMB
- Molding compound meets UL 94 V-0 flammability rating, RoHS-compliant
- Terminals: Tin plated leads, solderable per J-STD-002 and JESD22-B102
- Polarity:Color band denotes cathode end

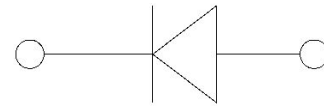

### ■ Maximum Ratings (Ta=25°C Unless otherwise specified)

PARAMETER	Symbol	Unit	GR2						
			A	B	D	G	J	K	M
Maximum Repetitive Peak Reverse Voltage	V <sub>RRM</sub>	V	50	100	200	400	600	800	1000
Maximum RMS Voltage	V <sub>RMS</sub>	V	35	70	140	280	420	560	700
Maximum DC blocking Voltage	V <sub>DC</sub>	V	50	100	200	400	600	800	1000
Average Forward Current @Half-sine wave, Resistance load, Tc(Fig.1)	I <sub>o</sub>	A	2.0						
Forward Surge Current (Non-repetitive) @60HZ sine wave, 1 cycle, Ta=25°C	I <sub>FSM</sub>	A	50						
Current squared time @1ms≤t.3≤ms Ta=25°C, Rating of per diode	I <sup>2</sup> t	A <sup>2</sup> s	10.4						
Thermal Resistance(Typical) @Between junction and ambient	R <sub>θJ-A</sub>	°C/W	55						
Storage Temperature	T <sub>stg</sub>	°C	-55 ~ +150						
Junction Temperature	T <sub>j</sub>	°C	-55 ~ +150						

### ■ Electrical Characteristics (Ta=25°C Unless otherwise specified)

PARAMETER	Symbol	Unit	Conditions	GR2					
				A	B	D	G	J	K
Peak Forward Voltage	V <sub>FM</sub>	V	I <sub>F</sub> = 2.0A	1.3					
Peak Reverse Current	I <sub>RRM</sub>	μA	VR = V <sub>DC</sub> @Ta=25°C	5					
			VR = V <sub>DC</sub> @Ta=125°C	200					
Maximum reverse recovery time	T <sub>rr</sub>	ns	I <sub>F</sub> =0.5A, I <sub>R</sub> =1.0A, I <sub>rr</sub> =0.25A	150			250		500



# GR2A THRU GR2M

## ■ Characteristics (Typical)

FIG.1: Io-TL Curve

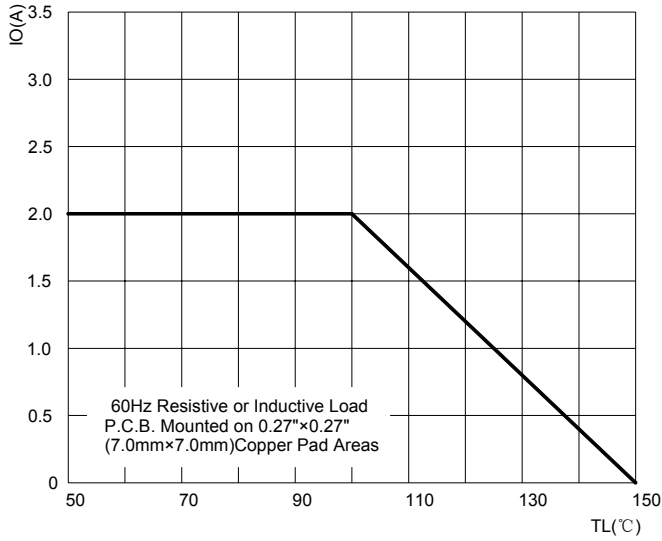

FIG.2: Forward Surge Current Capability

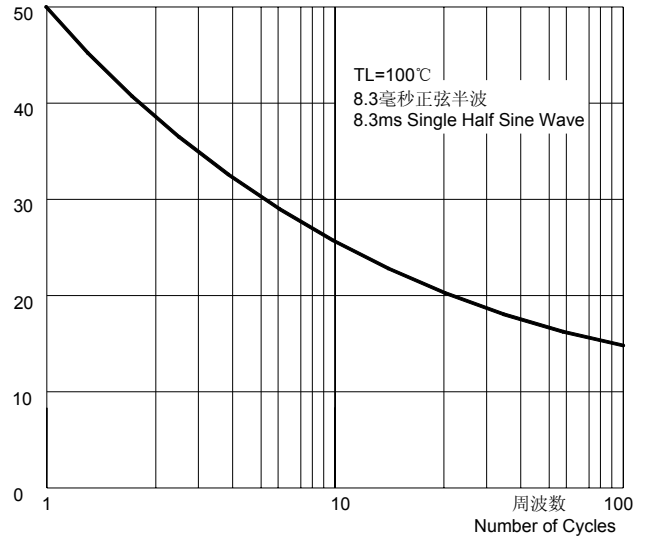

FIG.3: Forward Voltage

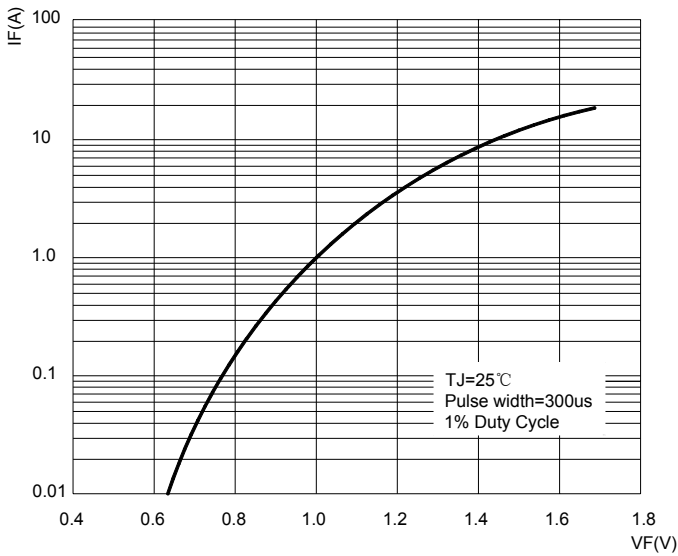

FIG.4: Typical Reverse Characteristics

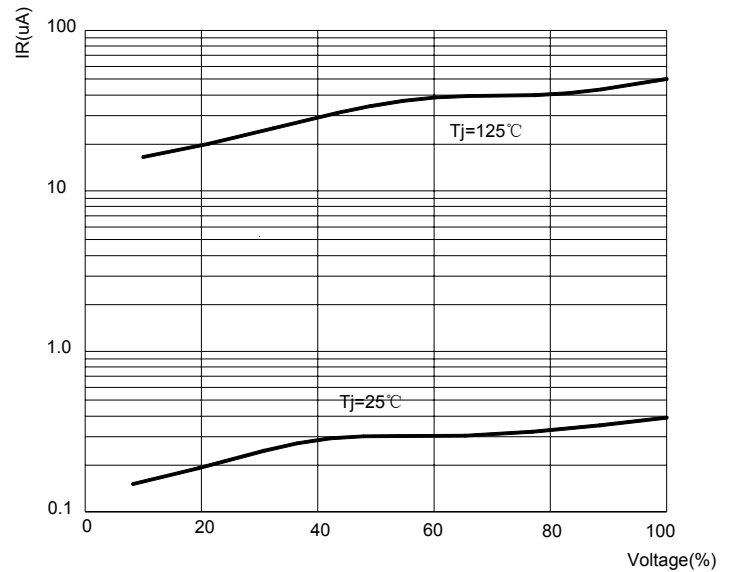
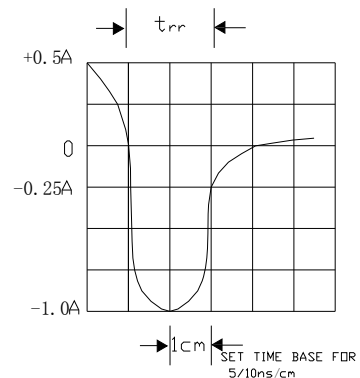
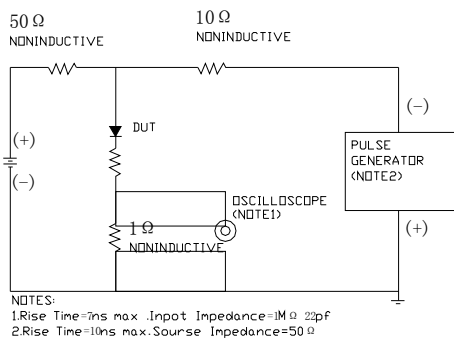

FIG.5: Diagram of circuit and Testing wave form of reverse recovery time



## GR2A THRU GR2M

### ■ Ordering Information (Example)

PREFERED	PACKAGE CODE	MINIMUM PACKAGE(pcs)	INNER BOX QUANTITY(pcs)	OUTER CARTON QUANTITY(pcs)	DELIVERY MODE
GR2A THRU GR2M	SMB	3000	6000	48000	13"reel

### ■ Outline Dimensions

