

Data sheet | Item number: 249-116

Screwless end stop; 6 mm wide; for DIN-rail 35 x 15 and 35 x 7.5; gray

<https://www.wago.com/249-116>

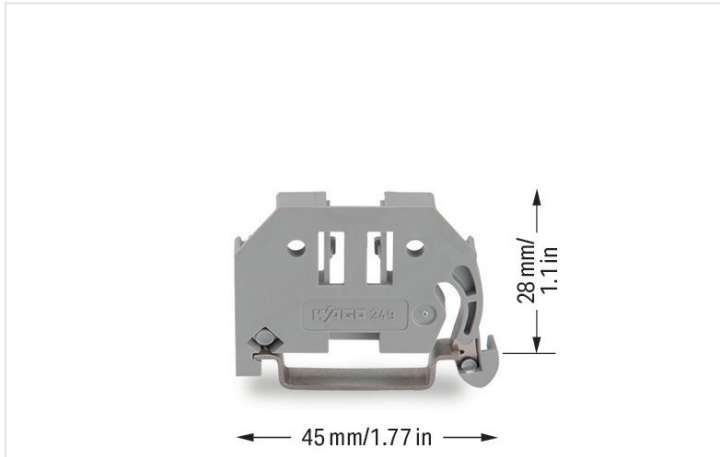

Color: ■ gray

Notes

Note

Snap on – that's it!

Assembling the new WAGO screwless end stop is as simple and quick as snapping a WAGO rail-mount terminal block onto the rail.

Tool free!

A tool-free design allows rail-mount terminal blocks to be safely and economically secured against any movement on all DIN-35 rails per DIN EN 60715 (35 x 7.5 mm; 35 x 15 mm).

Entirely without screws!

The "secret" to a perfect fit lies in the two small clamping plates which keep the end stop in position, even if the rails are mounted vertically.

Simply snap on – that's it!

In addition, costs are significantly reduced when using large numbers of end stops. Additional benefit: Three marker slots for all WAGO rail-mount terminal block markers and one snap-in hole for WAGO adjustable height group marker carriers offer individual marking options.

Technical data

Main product function	Mounting accessories
Mounting type	DIN-35 rail

Physical data

Width	6 mm / 0.236 inches
Height	44 mm / 1.732 inches

Material data

Color	gray
Flammability class per UL94	V0
Fire load	0.104 MJ
Weight	3.5 g

Commercial data	
Product Group	2 (Terminal Block Accessories)
eCl@ss 10.0	27-14-11-35
eCl@ss 9.0	27-14-11-35
ETIM 7.0	EC001041
ETIM 6.0	EC001041
PU (SPU)	100 (25) Stück
Packaging type	Box
Country of origin VKOrg Germany	CN
GTIN	4017332270823
Customs tariff number VKOrg Germany	39269097900

Downloads

Environmental Product Compliance

Compliance Search	
Environmental Product Compliance 249-116	↓

Documentation

Bid Text			
249-116	19.02.2019	xml 2.66 KB	↓
249-116	31.08.2017	doc 23.50 KB	↓

CAD/CAE-Data

CAD data	
2D/3D Models 249-116	↓

CAE data	
EPLAN Data Portal 249-116	↓
WSCAD Universe 249-116	↓
ZUKEN Portal 249-116	↓

1 Compatible products



1.1 Optional accessories

1.1.1 Marking

























1.1.1.1 Group marker carrier

Item no.: 2009-163 Group marker carrier; gray	Item no.: 209-140 Group marker carrier; gray	Item no.: 209-141 Group marker carrier; gray	Item no.: 209-142 Group marker carrier; gray
Item no.: 249-105 Group marker carrier; gray	Item no.: 249-118 Group marker carrier; gray	Item no.: 249-119 Group marker carrier; gray	Item no.: 709-118 Group marker carrier; gray
Item no.: 709-119 Group marker carrier; gray	Item no.: 209-112 Group marker carrier; white	Item no.: 249-120 Group marker carrier; white	

1.1.1.2 Label

 Item no.: 210-808 Labels; for Smart Printer; 9.5 x 25 mm; white	 Item no.: 210-708 Labels; for TP printers; 9.5 x 25 mm; white
---	---

1.1.1.3 Marker

 Item no.: 2009-145/000-006 Mini-WSB Inline; for Smart Printer; 1700 pieces on roll; stretchable 5 - 5.2 mm; plain; snap-on type; blue	 Item no.: 2009-145/000-007 Mini-WSB Inline; for Smart Printer; 1700 pieces on roll; stretchable 5 - 5.2 mm; plain; snap-on type; gray	 Item no.: 2009-145/000-023 Mini-WSB Inline; for Smart Printer; 1700 pieces on roll; stretchable 5 - 5.2 mm; plain; snap-on type; green	 Item no.: 2009-145/000-012 Mini-WSB Inline; for Smart Printer; 1700 pieces on roll; stretchable 5 - 5.2 mm; plain; snap-on type; orange
 Item no.: 2009-145/000-005 Mini-WSB Inline; for Smart Printer; 1700 pieces on roll; stretchable 5 - 5.2 mm; plain; snap-on type; red	 Item no.: 2009-145/000-024 Mini-WSB Inline; for Smart Printer; 1700 pieces on roll; stretchable 5 - 5.2 mm; plain; snap-on type; violet	 Item no.: 2009-145 Mini-WSB Inline; for Smart Printer; 1700 pieces on roll; stretchable 5 - 5.2 mm; plain; snap-on type; white	 Item no.: 2009-145/000-002 Mini-WSB Inline; for Smart Printer; 1700 pieces on roll; stretchable 5 - 5.2 mm; plain; snap-on type; yellow
 Item no.: 248-501/000-006 Mini-WSB marking card; as card; not stretchable; plain; snap-on type; blue	 Item no.: 248-501/000-007 Mini-WSB marking card; as card; not stretchable; plain; snap-on type; gray	 Item no.: 248-501/000-023 Mini-WSB marking card; as card; not stretchable; plain; snap-on type; green	 Item no.: 248-501/000-017 Mini-WSB marking card; as card; not stretchable; plain; snap-on type; light green
 Item no.: 248-501/000-012 Mini-WSB marking card; as card; not stretchable; plain; snap-on type; orange	 Item no.: 248-501/000-005 Mini-WSB marking card; as card; not stretchable; plain; snap-on type; red	 Item no.: 248-501/000-024 Mini-WSB marking card; as card; not stretchable; plain; snap-on type; violet	 Item no.: 248-501 Mini-WSB marking card; as card; not stretchable; plain; snap-on type; white
 Item no.: 248-501/000-002 Mini-WSB marking card; as card; not stretchable; plain; snap-on type; yellow	 Item no.: 793-5501/000-006 WMB marking card; as card; for terminal block width 5 - 17.5 mm; stretchable 5 - 5.2 mm; plain; snap-on type; blue	 Item no.: 793-5501/000-007 WMB marking card; as card; for terminal block width 5 - 17.5 mm; stretchable 5 - 5.2 mm; plain; snap-on type; gray	 Item no.: 793-5501/000-023 WMB marking card; as card; for terminal block width 5 - 17.5 mm; stretchable 5 - 5.2 mm; plain; snap-on type; green
 Item no.: 793-5501/000-017 WMB marking card; as card; for terminal block width 5 - 17.5 mm; stretchable 5 - 5.2 mm; plain; snap-on type; light green	 Item no.: 793-5501/000-012 WMB marking card; as card; for terminal block width 5 - 17.5 mm; stretchable 5 - 5.2 mm; plain; snap-on type; orange	 Item no.: 793-5501/000-005 WMB marking card; as card; for terminal block width 5 - 17.5 mm; stretchable 5 - 5.2 mm; plain; snap-on type; red	 Item no.: 793-5501/000-024 WMB marking card; as card; for terminal block width 5 - 17.5 mm; stretchable 5 - 5.2 mm; plain; snap-on type; violet

1.1.1.3 Marker



Item no.: 793-5501

WMB marking card; as card; for terminal block width 5 - 17.5 mm; stretchable 5 - 5.2 mm; plain; snap-on type; white

Item no.: 793-5501/000-002

WMB marking card; as card; for terminal block width 5 - 17.5 mm; stretchable 5 - 5.2 mm; plain; snap-on type; yellow

Item no.: 793-501/000-006

WMB marking card; as card; not stretchable; plain; snap-on type; blue

Item no.: 793-501/000-007

WMB marking card; as card; not stretchable; plain; snap-on type; gray



Item no.: 793-501/000-023

WMB marking card; as card; not stretchable; plain; snap-on type; green

Item no.: 793-501/000-017

WMB marking card; as card; not stretchable; plain; snap-on type; light green

Item no.: 793-501/000-012

WMB marking card; as card; not stretchable; plain; snap-on type; orange

Item no.: 793-501/000-005

WMB marking card; as card; not stretchable; plain; snap-on type; red



Item no.: 793-501/000-024

WMB marking card; as card; not stretchable; plain; snap-on type; violet

Item no.: 793-501

WMB marking card; as card; not stretchable; plain; snap-on type; white

Item no.: 793-501/000-002

WMB marking card; as card; not stretchable; plain; snap-on type; yellow

Item no.: 2009-115/000-006

WMB-Inline; for Smart Printer; 1500 pieces on roll; stretchable 5 - 5.2 mm; plain; snap-on type; blue



Item no.: 2009-115/000-007

WMB-Inline; for Smart Printer; 1500 pieces on roll; stretchable 5 - 5.2 mm; plain; snap-on type; gray

Item no.: 2009-115/000-023

WMB-Inline; for Smart Printer; 1500 pieces on roll; stretchable 5 - 5.2 mm; plain; snap-on type; green

Item no.: 2009-115/000-017

WMB-Inline; for Smart Printer; 1500 pieces on roll; stretchable 5 - 5.2 mm; plain; snap-on type; light green

Item no.: 2009-115/000-012

WMB-Inline; for Smart Printer; 1500 pieces on roll; stretchable 5 - 5.2 mm; plain; snap-on type; orange

Installation notes

Installation



Snap-on mounting

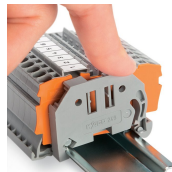

That's it!



Removing an end stop from the DIN-rail.