

FEATURES

- Mechanical keyed housings**
Prevents accidental mating of components operating at different voltage levels
- Single-piece housing and unitized construction**
Provides industrial quality and durability
- PCB mounted Quick disconnect**
Avoids the need for unfastening ring type terminals
- Straight and right angle terminal**
Provides flexibility of parallel or perpendicular mounting to the PCB
- Genderless design**
Makes assembly quick and easy and reduces number of parts stocked
- Flat wiping contact system**
Allows for minimal contact resistance at high current, wiping action cleans contact surface during disconnection
- Silver plated contacts**
Offers greater longevity when using high power, elevated temperature applications
- UL approved for current interrupt**
Safe for "Hot Plug" of battery power
- Wide product range - for 50, 120, 175 and 350 amps**
Allows versatility to choose product best suited to design requirements
- UL94 V-0 housing material**
Provides security in knowledge that the connector chosen meets strict UL flammability ratings



PRODUCT RANGE

UL Current Rating (Amperes)*	50* to 350*
UL Voltage Ratings (Volts)	600*
Contact Barrel Wire Size (AWG)	#16 to 300 mcm
(mm ²)	1.3 to 152.0
Maximum Wire Insulation Diameter (inches)	0.44 to 1.10
(mm)	11.2 to 27.9
AVG Contact Resistance* (micro-ohms)	200 to 50
Insulation Withstanding Test Voltage (Volts AC/DC)	2200
Contact Retention Force (lbf)	50 to 500
Life	
a. No load (Contact/Disconnect Cycles)	To 10,000
b. Under Load (Hot Plug) Max Amps (250 cycles @ 120V)	50A to 100A
Avg. Connection/Disconnect (lbf)	15 to 35
Operating Temperature Range °C**	-20° to 105°
°F	-4° to 221°
Flammability Rating of Housing Material	UL94 V-0



* UL Rated for 65°C largest wire or cable size

** Contact factory for higher temperature rated connectors

Recommended Voltage Key Color Code

Voltage	12V	18V	24V	36V	48V	72V	80V	96V	120V	144V
Color	Yellow	Orange	Red	Gray	Blue	Green	Black	Brown	Purple	White

PRODUCT INFORMATION

Invented by Anderson Power Products®, the innovative SB® connectors provide cost-effective reliability, design flexibility and mistake-proof capability for your products' manufacture, installation and maintenance. APP's 2 & 3 pole connectors are available for 50, 120, 175 and 350 amp ratings for use to 600 Volts continuous AC or DC operation. There are SB® connectors for many applications and wire sizes, #16 (1.3 mm²) to 300 mcm (152.0 mm²). Mechanical keys ensure connectors will only mate with connectors of the same color. Different color housings are selected to identify voltages, thus preventing mismatching of the power supply system.

The housings are interchangeable and genderless interconnects. Insert contacts into housings and plug together for a clever, simple and low-cost solution to power interconnection. Low-detent contacts are also offered for low insertion/withdrawal force applications. Contacts are available in reeled and loose piece designs to support all production needs from very high volumes to engineering prototype and low-volume customized products.

Markets: UPS Systems, Telecommunications, Forklift Trucks, Wheelchairs, Electric Vehicles, Chargers, Power Electronics & Much More.



© CSA Certified
File No. LR25154



File No. E26226

All Data Subject To Change Without Notice

HEADQUARTERS: 13 Pratts Junction Road, P.O. Box 579, Sterling, MA 01564 T:978-422-3600 F:978-422-3700

EUROPE: Rathealy Road, Fermoy Co. Cork, Ireland T:353-(0)25-32277 F:353-(0)25-32296

ASIA/PACIFIC: IDEAL Anderson Asia Pacific Ltd., Unit 922-928 Topsail Plaza, 11 On Sum Street, Shatin N.T., Hong Kong T:852-2636-0836 F:852-2635-9036

CHINA: IDEAL Anderson Technologies (Shenzhen) Ltd., Block A8 Tantou W. Ind. Par, Songgang Baoan District, Shenzhen, P.R. China 51810 T: 86-755-2768-2118 F: 86-755-2768-2218

TAIWAN: IDEAL Anderson Asia Pacific Ltd., Taiwan Branch, 4F.-2, No.116, Dadun 20th St., Situn District, Taichung City 407, Taiwan (R.O.C.) T: 886-4-2310-6451 F:886-4-2310-6460

www.andersonpower.com

The innovative SB[®] connectors provide cost-effective reliability, design flexibility and safety for your products' manufacture, installation and maintenance.

APP's 2 pole connector is available with a 50 amp rating, 600 Volts continuous AC or DC operation. There are SB[®] connectors for many applications and wire sizes, #6 to #16 AWG (13.3 to 1.3 mm²). Mechanical keys ensure connectors will only mate with connectors of the same color. Different color housings are selected to identify voltages, thus preventing mismatching of the power supply system.

FEATURES

- Mechanical keyed housings**
Prevents accidental mating of components operating at different voltage levels
- Single-piece housing and unitized construction**
Provides industrial quality and durability
- Genderless design**
Makes assembly quick and easy and reduces number of parts stocked



PRODUCT SPECIFICATIONS

Connector Model	SB [®] 50	Connector Model	SB [®] 50
UL Current Rating (Amperes)*	50*	Life	
UL Voltage Ratings (Volts)	600*	a. No load (Contact/Disconnect Cycles)	To 10,000
Contact Barrel Wire Size (AWG) (mm ²)	#6 to #16 13.3 to 1.3	b. Under Load (Hot Plug 250 cycles @ 120V)	50A
Maximum Wire Insulation Diameter (inches) (mm)	0.44 11.2	Avg. Connection/Disconnect (lbf)	10 - low detent 15 - high detent
AVG Contact Resistance* (micro-ohms)	200	Operating Temperature Range °C** °F	-20° to 105° -4° to 221°
Insulation Withstanding Test Voltage (Volts AC/DC)	2200	Flammability Rating of Housing Material	UL94 V-0
Contact Retention Force (lbf)	50		



* UL Rated for 65°C largest wire or cable size

** Contact factory for higher temperature rated connector

SB[®], UL and CSA Reference: This equipment is an Underwriters Laboratories Inc[®] recognized component.

It is also listed by the Canadian Standards Association as certified.

ORDERING INFORMATION

2 Pole Housing & 50 amp Contacts

Part Number	Housing Color	Wire AWG	Wire sq. mm
6319	Gray	#6	13.3
6319G1	Gray	#10/12	5.3/3.3
6331G1	Red	#6	13.3
6331G2	Red	#10/12	5.3/3.3
6331G3	Black	#6	13.3
6331G4	Black	#10/12	5.3/3.3
6331G5	Blue	#6	13.3
6331G6	Blue	#10/12	5.3/3.3
6331G7	Yellow	#6	13.3
6331G8	Yellow	#10/12	5.3/3.3
6331G9	Green	#6	13.3
6331G10	Green	#10/12	5.3/3.3
6331G11	Orange	#6	13.3
6331G12	Orange	#10/12	5.3/3.3

* LD - low detent or HD - high detent

Note: For additional colors please contact customer service

Housings Only

Part Number	Description
992	Gray
992G1	Red
992G2	Black
992G4	Blue
992G5	Yellow
992G6	Green
992G7	Orange

50 amp Contacts*

Part Number	Description	Wire	
		AWG	sq. mm
903G1	Contact set (2) 5900	#6	13.3
904G1	Contact set (2) 5915	#10/12	5.3/3.3
5900	Individual - HD	#6	13.3
1307	Individual - LD	#6	13.3
5952	Individual - HD	#8	8.4
5953	Individual - LD	#10/12	5.3/3.3
5914	Individual - HD	#10	5.26
5915	Individual - HD	#10/12	5.3/3.3

50 amp contacts continued

Part Number	Description	Wire AWG	Wire sq. mm
265G1	Reel, silver - HD	#6/8	13.3/8.4
265G2	Reel, silver - HD	#10/12	5.3/3.3
265G3	Reel, silver - LD	#6/8	13.3/8.4
265G4	Reel, silver - LD	#10/12	5.3/3.3
265G5	Reel, tin - HD	#6/8	13.3/8.4
265G6	Reel, tin - HD	#10/12	5.3/3.3
265G7	Reel, tin - LD	#6/8	13.3/8.4
265G8	Reel, tin - LD	#10/12	5.3/3.3
75BBS	Bus bar contact	N/A	N/A

Accessories

Part Number	Description
SB50-HDL-Red	Handle & hardware, red
134G1	Dust cover, red
990	Cable clamp & hardware, self attaching, 2C
990G2	Cable clamp, 2 single conductors

HEADQUARTERS: 13 Pratts Junction Road, P.O. Box 579, Sterling, MA 01564 T:978-422-3600 F:978-422-3700

EUROPE: Rathealy Road, Fermoy Co. Cork, Ireland T:353-(0)25-32277 F:353-(0)25-32296

ASIA/PACIFIC: IDEAL Anderson Asia Pacific Ltd., Unit 922-928 Topsail Plaza, 11 On Sum Street, Shatin N.T., Hong Kong T:852-2636-0836 F:852-2635-9036

CHINA: IDEAL Anderson Technologies (Shenzhen) Ltd., Block A8 Tantou W. Ind. Par, Songgang Baoan District, Shenzhen, P.R. China 51810 T: 86-755-2768-2118 F: 86-755-2768-2218

TAIWAN: IDEAL Anderson Asia Pacific Ltd., Taiwan Branch, 4F-2, No.116, Dadun 20th St., Situn District, Taichung City 407, Taiwan (R.O.C.) T: 886-4-2310-6451 F:886-4-2310-6460

www.andersonpower.com

ORDERING INFORMATION

accessories continued

Part Number	Description
990G1	Cable clamp & hardware-screw mounting-2C
5905	Cable clamp-1 twin conductor with hardware
110G57	Lock nut for use with bus bar contact

Bushings

Part Number	Description	Reduces From AWG	sq. mm
5910	Use with 5900 or 1307	#6 to #10/12	13.3 to 5.3/3.3
5912	Use with 5900 or 1307	#6 to #8	13.3 to 8.4
5913	Use with 5900 or 1307	#6 to #14/16	13.3 to 2.1/1.3

Tooling

Part Number	Description
1309G4	Hand tool
1387G1	Pneumatic tool
1388G6	- die for #6 to #16 AWG
1388G7	- die for #10 to #12 AWG
1389G6	- locator for #6 to #16 AWG
1389G7	- locator for #10 to #12 AWG
260G16	Applicator only (110V & 220V)
*	Applicator & Press (220V, 50Hz)
*	Press only (110V, 60Hz)

* Consult factory

DIMENSIONS

Housing

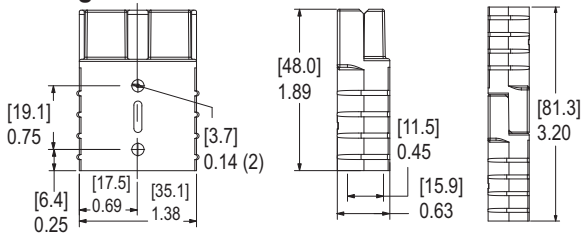

Bus Bar Layout

Part Number	- J -	- K -	- L -	- M -
	mm in.	mm in.	mm in.	mm in.
75BBS	19.1 0.75	17.3(min) 0.68(min)	6.73 0.265	2.92 0.115

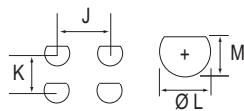

Mounting Dimensions

Bus Bar Mounting Table

Part Number	-E-	-F-
	mm in.	mm in.
75BBS	53.3 2.10	5.10 0.20

Part Number	-J-
	mm in.
75BBS	3.0 - 12.7 0.12 - 0.50

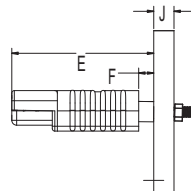

TEMPERATURE RISE CHARTS

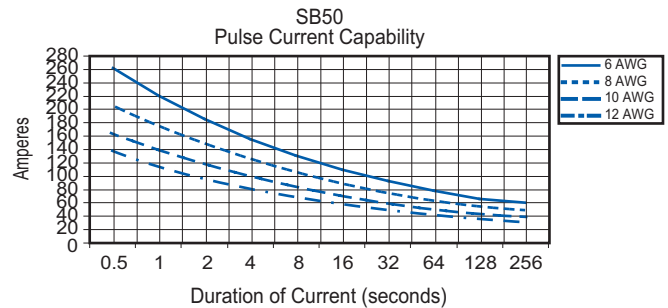
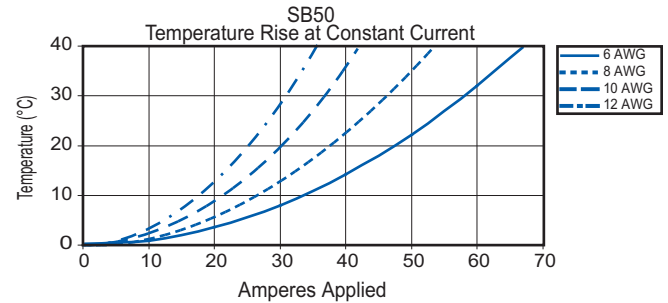

Contacts

Part Number	-A-	-B-	-C-	-D-	-E-
	mm in.	mm in.	mm in.	mm in.	mm in.
1307	30.0 1.18	7.2 0.28	5.6 0.22	11.4 0.45	7.1 0.28
5900	30.0 1.18	7.2 0.28	5.6 0.22	11.4 0.45	7.1 0.28
5914	29.7 1.17	4.8 0.19	3.5 0.14	11.4 0.45	7.1 0.28
5915	30.0 1.18	7.2 0.28	3.5 0.14	11.4 0.45	7.1 0.28
5952	30.0 1.18	7.2 0.28	4.7 0.19	11.4 0.45	7.1 0.28
5953	30.0 1.18	7.2 0.28	3.5 0.14	11.4 0.45	7.1 0.28
904G1	30.0 1.18	7.2 0.28	3.5 0.14	11.4 0.45	7.1 0.28
903G1	30.0 1.18	7.2 0.28	5.6 0.22	11.4 0.45	7.1 0.28
265G1	31.8 1.25	9.1 0.36	9.1 0.36	22.9 0.90	8.1 0.32
265G2	31.8 1.25	7.4 0.29	6.9 0.27	22.9 0.90	8.1 0.32
265G3	31.0 1.22	9.1 0.36	9.1 0.36	22.9 0.90	8.1 0.32
265G4	31.0 1.22	7.4 0.29	6.9 0.27	22.9 0.90	8.1 0.32
265G5	31.8 1.25	9.1 0.36	9.1 0.36	22.9 0.90	8.1 0.32
265G6	31.8 1.25	7.4 0.29	6.9 0.27	22.9 0.90	8.1 0.32
265G7	31.0 1.22	9.1 0.36	9.1 0.36	22.9 0.90	8.1 0.32
265G8	31.0 1.22	7.4 0.29	6.9 0.27	22.9 0.90	8.1 0.32
75BBS	See Bus Bar Section				

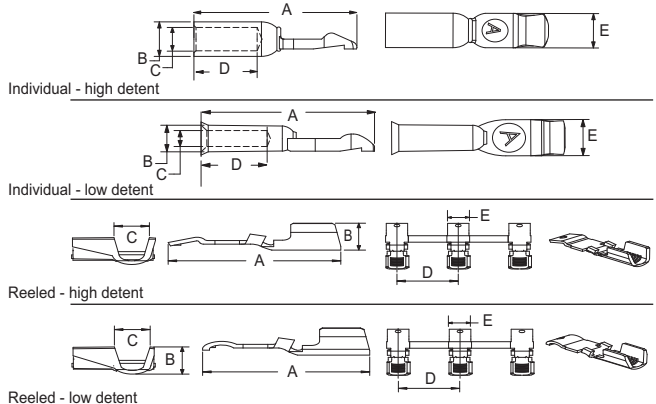

The innovative SB[®] connectors provide cost-effective reliability, design flexibility and safety for your products' manufacture, installation and maintenance.

APP's 2 pole connector is available with a 120 amp rating, 600 Volts continuous AC or DC operation. There are SB[®] connectors for many applications and wire sizes, #2 to #6 AWG (33.6 to 13.3 mm²). Mechanical keys ensure connectors will only mate with connectors of the same color. Different color housings are selected to identify voltages, thus preventing mismatching of the power supply system.

FEATURES

- Molded side grooves**
Allows for a secure panel mounting fit
- Mechanical keyed housings**
Prevents accidental mating of components operating at different voltage levels
- Single-piece housing and unitized construction**
Provides industrial quality and durability

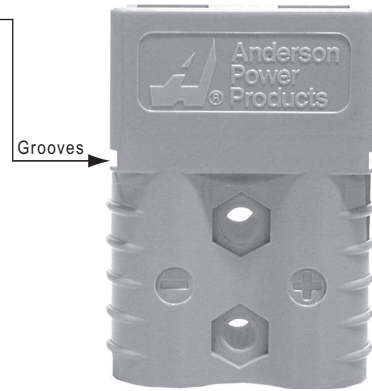

PRODUCT SPECIFICATIONS

Connector Model	SB [®] 120	Connector Model	SB [®] 120
UL Current Rating (Amperes)*	120*	Life	
UL Voltage Ratings (Volts)	600*	a. No load (Contact/Disconnect Cycles)	To 10,000
Contact Barrel Wire Size (AWG)	#2 to #6	b. Under Load (Hot Plug 250 cycles @ 120V)	60A
(mm ²)	33.3 to 13.3	Avg. Connection/Disconnect (lbf)	20
Maximum Wire Insulation Diameter (inches)	0.575	Operating Temperature Range °C**	-20° to 105°
(mm)	14.6	°F	-4° to 221°
AVG Contact Resistance* (micro-ohms)	136	Flammability Rating of Housing Material	UL94 V-0
Insulation Withstanding Test Voltage (Volts AC/DC)	2200		
Contact Retention Force (lbf)	100		



* UL Rated for 75°C largest wire or cable size
** Contact factory for higher temperature rated connector
SB[®], UL and CSA Reference: This equipment is an Underwriters Laboratories Inc[®] recognized component. It is also listed by the Canadian Standards Association as certified.

ORDERING INFORMATION

2 Pole Housing & 120 amp Contacts

Part Number	Housing Color	Wire	
		AWG	sq. mm
6800G1	Gray	#2	33.6
6801G1	Blue	#2	33.6
6802G1	Red	#2	33.6
6800G2	Gray	#4	21.1
6801G2	Blue	#4	21.1
6802G2	Red	#4	21.1
6800G3	Gray	#6	13.3
6801G3	Blue	#6	13.3
6802G3	Red	#6	13.3

Housing Only

Part Number	Description
6810G1	Gray housing
6810G2	Blue housing
6810G3	Red housing

120 amp Contacts

Part Number	Description	Wire	
		AWG	sq. mm
6811G1	Contact set (2)	#2	33.6
6811G2	Contact set (2)	#4	21.1
6811G3	Contact set (2)	#6	13.3
120BBS	Bus Bar	N/A	N/A

Bushings

Part Number	Description	Wire	
		AWG	sq. mm
5919	Use with 6811G1	#2 to #4	33.6/21.2
5920	Use with 6811G1	#2 to #6	33.6/13.3
5921	Use with 6811G1	#2 to #8	33.6/8.4

Accessories

Part Number	Description
SB120-HDL-RED	SB handle with hardware-red
981G1	Cable clamp for 2 single conductor cables
110G57	Lock nut for use with Bus bar contact
134G4	Dust cover, red
1467G1	Panel mount bracket, set (2)
981G2	Twin conduit cable clamp

Tooling

Part Number	Description
1368	Hand tool - #2 to #8
1387G1	Pneumatic tool - #2 to #8
1388G4	- die for #2 to #8
1389G4	- locator #2 to #8

Note: For additional colors please contact customer service

HEADQUARTERS: 13 Pratts Junction Road, P.O. Box 579, Sterling, MA 01564 T:978-422-3600 F:978-422-3700

EUROPE: Rathealy Road, Fermoy Co. Cork, Ireland T:353-(0)25-32277 F:353-(0)25-32296

ASIA/PACIFIC: IDEAL Anderson Asia Pacific Ltd., Unit 922-928 Topsail Plaza, 11 On Sum Street, Shatin N.T., Hong Kong T:852-2636-0836 F:852-2635-9036

CHINA: IDEAL Anderson Technologies (Shenzhen) Ltd., Block A8 Tantou W. Ind. Par, Songgang Baoan District, Shenzhen, P.R. China 51810 T: 86-755-2768-2118 F: 86-755-2768-2218

TAIWAN: IDEAL Anderson Asia Pacific Ltd., Taiwan Branch, 4F.-2, No.116, Dadun 20th St., Situn District, Taichung City 407, Taiwan (R.O.C.) T: 886-4-2310-6451 F:886-4-2310-6460

www.andersonpower.com

DIMENSIONS

Housing

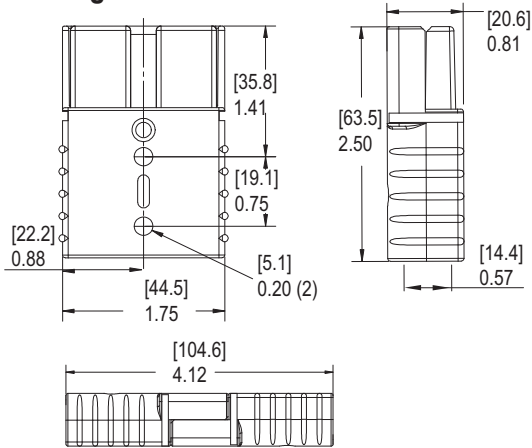

Contacts

Part Number	-A- mm in.	-B- mm in.	-C- mm in.	-D- mm in.
6811G1	50.8 2.00	11.1 0.44	8.7 0.34	21.6 0.85
6811G2	50.8 2.00	11.1 0.44	7.5 0.30	21.6 0.85
6811G3	50.8 2.00	11.1 0.44	5.6 0.22	21.6 0.85
120BBS	77.0 3.03	11.2 0.44	9.5 0.38	N/A #10-24Thd.

Part Number	Contact Detent	-E- mm in.	-F- mm in.	-J- mm in.	-K- mm in.
6811G1	Low	10.4 0.41	N/A	N/A	N/A
6811G2	Low	10.4 0.41	N/A	N/A	N/A
6811G3	Low	10.4 0.41	N/A	N/A	N/A
120BBS	N/A	68.6 2.70	5.1 0.20	23.6 0.93	21.1 (min) 0.83(min)

Part Number	Contact Detent	-L- mm in.	-M- mm in.
120BBS	N/A	7.37 0.29	6.35 0.25

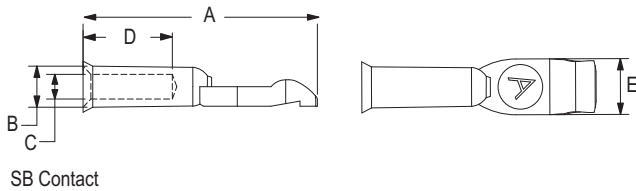

TEMPERATURE RISE CHARTS

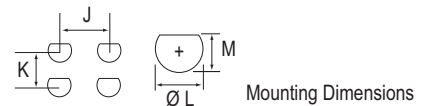
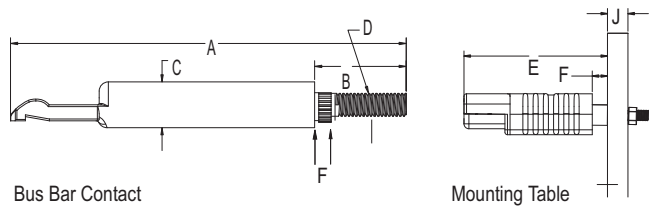
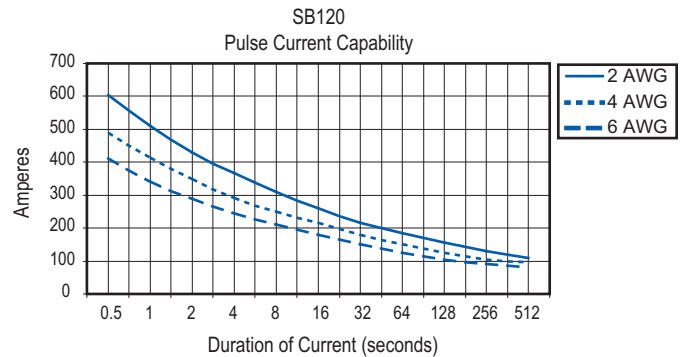
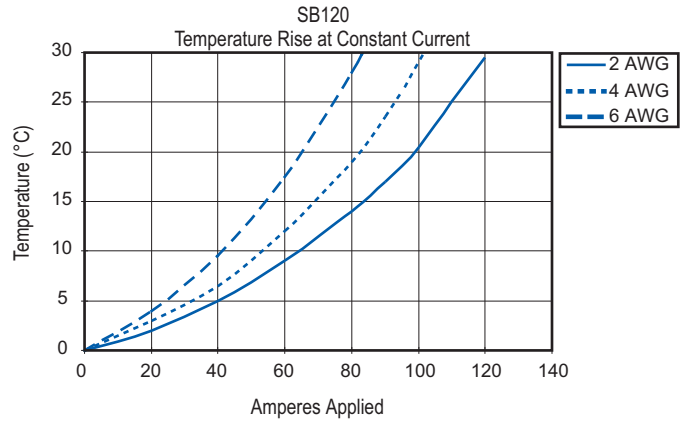

The innovative SB[®] connectors provide cost-effective reliability, design flexibility and safety for your products' manufacture, installation and maintenance.

APP's 2 & 3 pole connectors are available with a 175 amp rating, 600 Volts continuous AC or DC operation. There are SB[®] connectors for many applications and wire sizes, #4 to 1/0 AWG (21.1 to 53.5mm²). Mechanical keys ensure connectors will only mate with connectors of the same color. Different color housings are selected to identify voltages, thus preventing mismatching of the power supply system.

FEATURES

- Mechanical keyed housings**
Prevents accidental mating of components operating at different voltage levels
- Flat wiping contact system**
Allows for minimal contact resistance at high current, wiping action cleans contact surface during disconnection
- Genderless design**
Makes assembly quick and easy and reduces number of parts stocked



PRODUCT SPECIFICATIONS

Connector Model	SB [®] 175	Connector Model	SB [®] 175
UL Current Rating (Amperes)*	175*	Life	
UL Voltage Ratings (Volts)	600*	a. No load (Contact/Disconnect Cycles)	To 10,000
Contact Barrel Wire Size (AWG) (mm ²)	#4 to 1/0 21.1 to 53.5	b. Under Load (Hot Plug 250 cycles @ 120V)	75A
Maximum Wire Insulation Diameter (inches) (mm)	0.75 19.01	Avg. Connection/Disconnect (lbf)	25 (SB 2 Pole) 35 (SB 3 Pole)
AVG Contact Resistance* (micro-ohms)	100	Operating Temperature Range °C** °F	-20° to 105° -4° to 221°
Insulation Withstanding Test Voltage (Volts AC/DC)	2200	Flammability Rating of Housing Material	UL94 V-0
Contact Retention Force (lbf)	300		

* UL Rated for 65°C largest wire or cable size
 ** Contact factory for higher temperature rated connector
 SB[®], UL and CSA Reference: This equipment is an Underwriters Laboratories Inc[®] recognized component.
 It is also listed by the Canadian Standards Association as certified.

ORDERING INFORMATION

2 Pole Housing & 175 amp Contacts

Part Number	Housing Color	Wire AWG	Wire sq. mm
6325G1	Gray	1/0	53.5
6326G1	Blue	1/0	53.5
6327G1	Orange	1/0	53.5
6328G1	Yellow	1/0	53.5
6329G1	Red	1/0	53.5
6325G5	Gray	#2	33.6
6326G5	Blue	#2	33.6
6327G5	Orange	#2	33.6
6328G5	Yellow	#2	33.6
6329G5	Red	#2	33.6
6325G6	Gray	#4	21.1
6326G6	Blue	#4	21.1
6327G6	Orange	#4	21.1
6328G6	Yellow	#4	21.1
6329G6	Red	#4	21.1

Housings Only

Part Number	Description
940	Gray
941	Blue
942	Orange
943	Yellow
949	Red
2-7252G11	Black, no voltage key

175 amp Contacts

Part Number	Description	Wire AWG	Wire sq. mm
944	Contact set (2)	1/0	53.5
1382	Individual	1/0	53.5
947	Contact set (2)	#2	33.6
1383	Individual	#2	33.6
948	Contact set (2)	#4	21.1
1384	Individual	#4	21.2
948G1*	Contact set (2)	#6	13.3
1348*	Individual	#6	13.3
944G1	Contact set (2)	#1	42.4
1347	Individual	#1	42.4
180BBS	Bus bar contact	N/A	N/A

3 Pole Housing & 175 amp Contacts

Part Number	Housing Color	Wire AWG	Wire sq. mm
6316	Gray	1/0	53.5
6316G9	Gray	#1	42.4
6316G10	Gray	#2	33.6

3 Pole Housing Only

Part Number	Description
902	Gray, springs & hardware

* Thin wall
 Note: For additional colors please contact customer service

HEADQUARTERS: 13 Pratts Junction Road, P.O. Box 579, Sterling, MA 01564 T:978-422-3600 F:978-422-3700

EUROPE: Rathealy Road, Fermoy Co. Cork, Ireland T:353-(0)25-32277 F:353-(0)25-32296

ASIA/PACIFIC: IDEAL Anderson Asia Pacific Ltd., Unit 922-928 Topsail Plaza, 11 On Sum Street, Shatin N.T., Hong Kong T:852-2636-0836 F:852-2635-9036

CHINA: IDEAL Anderson Technologies (Shenzhen) Ltd., Block A8 Tantou W. Ind. Par, Songgang Baoan District, Shenzhen, PR. China 51810 T: 86-755-2768-2118 F: 86-755-2768-2218

TAIWAN: IDEAL Anderson Asia Pacific Ltd., Taiwan Branch, 4F.-2, No.116, Dadun 20th St., Situn District, Taichung City 407, Taiwan (R.O.C.) T: 886-4-2310-6451 F:886-4-2310-6460

www.andersonpower.com

ORDERING INFORMATION & DIMENSIONS

Accessories

Part Number	Description
995G1	Handle, hardware & lock washers - Gray
995G3	Handle, hardware & lock washers - Red
923	Manual release, locking half with clamps and hardware
924	Manual release, mounting half with clamps and hardware
110G56	Lock nut for use with Bus bar contact
SB175-lockout	Safety lockout
111197G1	Charger key
134G2	Dust cover
945	Cable clamps
945G3	Cable clamps-2 single conductor with hardware. Use with "A" frame only.
946G1	Cable clamps-1 twin conductor with hardware. Use with "A" frame only.

Bushings

Part Number	Description	Wire	
		AWG	sq. mm
5648	Use with 944	1/0 to #10	53.5 to 5.1
5663	Use with 944	1/0 to #6	53.5 to 13.3
5687	Use with 944	1/0 to #1	53.5 to 42.4
5690	Use with 944	1/0 to #2	53.5 to 33.6
5693	Use with 944	1/0 to #4	53.5 to 21.2

Tooling

Part Number	Description
1368	Hand tool for 1/0 to #1 (53.5/42.4)
1387G1	Pneumatic tool
1388G3	- die for 1/0 to #1 (53.5/42.4)
1388G5	- die for #4
1389G5	- locator for #4
1389G3	- locator for 1/0 to #1 (53.5/42.4)
1303G4	- die for 1/0 to #4 (53.5/21.1)
1304G4	- locator for 1/0 to #4 (53.5/21.1)

Housing

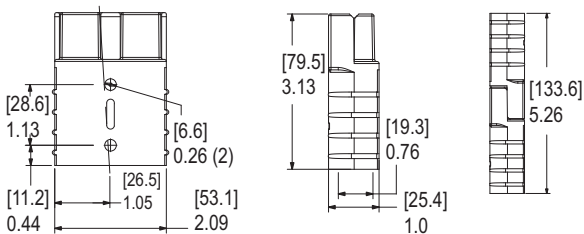

Bus Bar Mounting Table

Part Number	- E -		- F -	
	mm	in.	mm	in.
180BBS	88.9	3.50	10.2	0.40

Part Number	- J -	
	mm	in.
180BBS	5.0-19.0	0.20-0.75

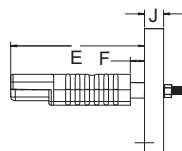

All Data Subject To Change Without Notice

TEMPERATURE RISE CHART

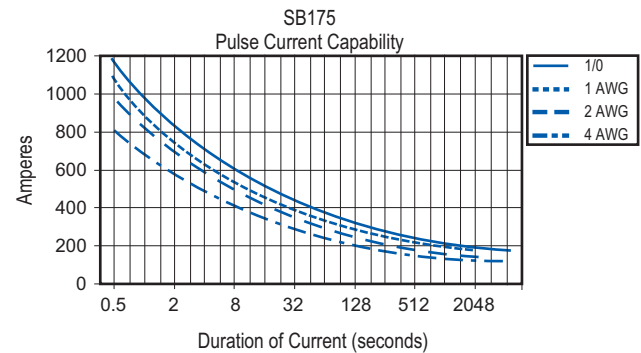
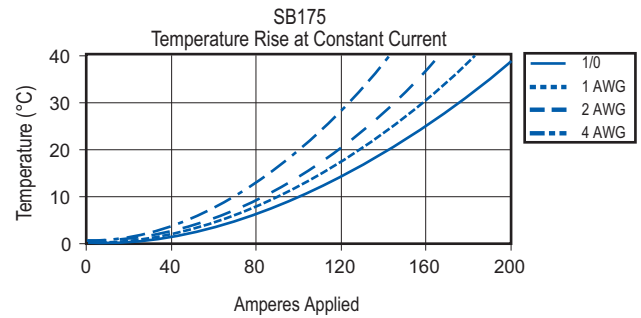

Contacts

Part Number	-A-		-B-		-C-		-D-	
	mm	in.	mm	in.	mm	in.	mm	in.
944	59.7	2.35	13.1	0.52	11.1	0.44	27.4	1.08
947	59.7	2.35	13.1	0.52	8.9	0.35	27.4	1.08
948	59.7	2.35	13.1	0.52	7.5	0.30	25.9	1.02
944G1	59.7	2.35	13.1	0.52	9.9	0.39	27.4	1.08
948G1	53.3	2.10	9.3	0.37	11.7	0.46	21.3	0.84
180BBS	109.0	4.29	25.4	1.00	12.7	0.50	N/A	1/4-20Thd.

Part Number	-E-		-F-	
	mm	in.	mm	in.
944	12.7	0.5	N/A	
947	12.7	0.5	N/A	
948	12.7	0.5	N/A	
944G1	12.7	0.5	N/A	
948G1	12.7	0.5	N/A	
180BBS	N/A		4.6	0.18

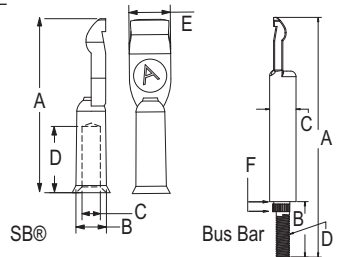

Bus Bar Layout

Part Number	- J -		- K -		- L -		- M -	
	mm	in.	mm	in.	mm	in.	mm	in.
180BBS	26.8	1.05	26.8(min)	1.05(min)	9.53	0.375	3.43	0.135

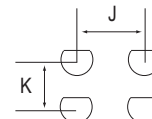

Mounting Dimensions

HEADQUARTERS: 13 Pratts Junction Road, P.O. Box 579, Sterling, MA 01564 T:978-422-3600 F:978-422-3700

EUROPE: Rathealy Road, Fermoy Co. Cork, Ireland T:353-(0)25-32277 F:353-(0)25-32296

ASIA/PACIFIC: IDEAL Anderson Asia Pacific Ltd., Unit 922-928 Topsail Plaza, 11 On Sum Street, Shatin N.T., Hong Kong T:852-2636-0836 F:852-2635-9036

CHINA: IDEAL Anderson Technologies (Shenzhen) Ltd., Block A8 Tantou W. Ind. Par, Songgang Baoan District, Shenzhen, P.R. China 51810 T: 86-755-2768-2118 F: 86-755-2768-2218

TAIWAN: IDEAL Anderson Asia Pacific Ltd., Taiwan Branch, 4F.-2, No.116, Dadun 20th St., Situn District, Taichung City 407, Taiwan (R.O.C.) T: 886-4-2310-6451 F:886-4-2310-6446

The innovative SB[®] connectors provide cost-effective reliability, design flexibility and safety for your products' manufacture, installation and maintenance.

APP's 2 pole connector is available with a 350 amp rating, 600 Volts continuous AC or DC operation. There are SB[®] connectors for many applications and wire sizes, 2/0 AWG to 300 mcm (67.4 to 152.0 mm²). Mechanical keys ensure connectors will only mate with connectors of the same color. Different color housings are selected to identify voltages, thus preventing mismatching of the power supply system.

FEATURES

- Mechanical keyed housings**
Prevents accidental mating of components operating at different voltage levels
- Single-piece housing and unitized construction**
Provides industrial quality and durability
- Genderless design**
Makes assembly quick and easy and reduces number of parts stocked



PRODUCT SPECIFICATIONS

Connector Model	SB [®] 350	Connector Model	SB [®] 350
UL Current Rating (Amperes)*	350*	Life	
UL Voltage Ratings (Volts)	600*	a. No load (Contact/Disconnect Cycles)	To 10,000
Contact Barrel Wire Size (AWG)	2/0 to 300 mcm	b. Under Load (Hot Plug 250 cycles @ 120V)	100A
(mm ²)	67.4 to 152.0	Avg. Connection/Disconnect (lbf)	30
Maximum Wire Insulation Diameter (inches)	1.10	Operating Temperature Range °C**	-20° to 105°
(mm)	27.9	°F	-4° to 221°
AVG Contact Resistance* (micro-ohms)	50	Flammability Rating of Housing Material	UL94 V-0
Insulation Withstanding Test Voltage (Volts AC/DC)	2200		
Contact Retention Force (lbf)	500		



* UL Rated for 65°C largest wire or cable size
 ** Contact factory for higher temperature rated connector
 SB[®], UL and CSA Reference: This equipment is an Underwriters Laboratories Inc[®] recognized component.
 It is also listed by the Canadian Standards Association as certified.

ORDERING INFORMATION

2 Pole Housing & 350 amp Contacts

Part Number	Housing Color	Wire	
		AWG	sq. mm
6320G1	Gray	2/0	67.4
6320G2	Gray	4/0	107.2
6320G4	Gray	300 mcm	152.0
6320G5	Gray	3/0	85.0
6321G1	Blue	2/0	67.4
6321G2	Blue	4/0	107.2
6321G4	Blue	300 mcm	152.0
6321G5	Blue	3/0	85.0
6322G1	Red	2/0	67.4
6322G2	Red	4/0	107.2
6322G4	Red	300 mcm	152.0
6322G5	Red	3/0	85.0
6323G1	Yellow	2/0	67.4
6323G2	Yellow	4/0	107.2
6323G4	Yellow	300 mcm	152.0
6323G5	Yellow	3/0	85.0

2 Pole Housing & 350 amp Contacts continued

Part Number	Description	Wire	
		AWG	sq. mm
6324G1	Green	2/0	67.4
6324G2	Green	4/0	107.2
6324G4	Green	300 mcm	152.0
6324G5	Green	3/0	85.0
6400G1	Orange	2/0	67.4
6400G2	Orange	4/0	107.2
6400G4	Orange	300 mcm	152.0
6400G5	Orange	3/0	85.0

Housings Only

Part Number	Color
906	Gray
912	Blue
913	Red

housings continued

Part Number	Color
914	Yellow
931	Green
932	Orange

Contacts

Part Number	Description	Wire	
		AWG	sq. mm
917	Contact set (2)	1/0	53.5
907	Contact set (2)	2/0	67.4
916	Contact set (2)	3/0	85.0
908	Contact set (2)	4/0	107.2
910	Contact set (2)	300 mcm	152.0
350BBS	Bus bar contact	N/A	N/A

Note: For additional colors please contact customer service

HEADQUARTERS: 13 Pratts Junction Road, P.O. Box 579, Sterling, MA 01564 T:978-422-3600 F:978-422-3700

EUROPE: Rathealy Road, Fermoy Co. Cork, Ireland T:353-(0)25-32277 F:353-(0)25-32296

ASIA/PACIFIC: IDEAL Anderson Asia Pacific Ltd., Unit 922-928 Topsail Plaza, 11 On Sum Street, Shatin N.T., Hong Kong T:852-2636-0836 F:852-2635-9036

CHINA: IDEAL Anderson Technologies (Shenzhen) Ltd., Block A8 Tantou W. Ind. Par, Songgang Baoan District, Shenzhen, P.R. China 51810 T: 86-755-2768-2118 F: 86-755-2768-2218

TAIWAN: IDEAL Anderson Asia Pacific Ltd., Taiwan Branch, 4F.-2, No.116, Dadun 20th St., Situn District, Taichung City 407, Taiwan (R.O.C.) T: 886-4-2310-6451 F:886-4-2310-6460

www.andersonpower.com

ORDERING INFORMATION

Accessories

Part Number	Description
995G2	Handle & hardware-gray
995G4	Handle & hardware-red
919	Manual release-locking half-cable clamps, hardware & lock out spring for the battery
919G1	Mounting half-mounting half-hardware & lock out spring for battery
922G1	Mounting half-hardware for truck or charger
111197G1	Charger key
134G3	Dust cover
996G1	Cable clamps-2 single conductor with hardware
911	Cable clamps-2 single conductor, cables with hardware and steel handle
SB350-lockout	Safety lockout

Bushings

Part Number	Description	Wire	
		AWG	sq. mm
5918	Use with 907	2/0 to 1/0	67.4 to 53.5

Tooling

Part Number	Description
1368	Hand tool for 1/0 to 300 mcm
1387G1	Pneumatic tool
1387G2	Pneumatic tool
1388G2	- die for 2/0 to 3/0
1389G2	- locator for 2/0 to 3/0
1388G1	- die for 4/0
1389G1	- locator for 4/0
1304G9	- loctor for 4/0
1303G3	- die for 4/0

Housing

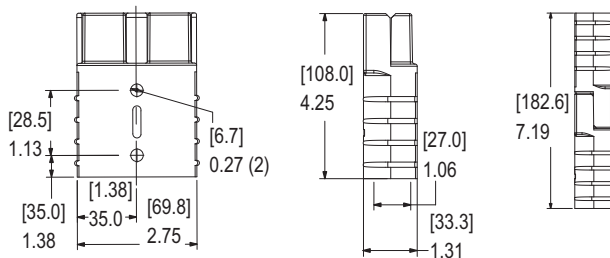

Bus Bar Layout

Part Number	- J -	- K -	- L -	- M -
	mm in.	mm in.	mm in.	mm in.
350BBS	34.9 1.38	33.8(min) 1.33(min)	13.34 0.525	11.76 0.463

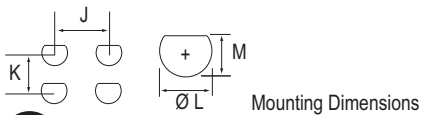

File No. E26226 All Data Subject To Change Without Notice

TEMPERATURE RISE CHART

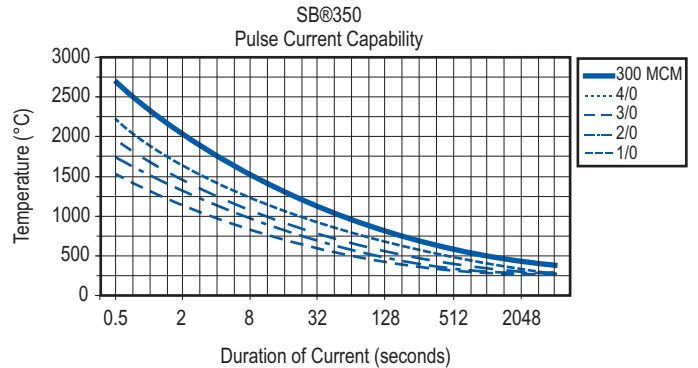
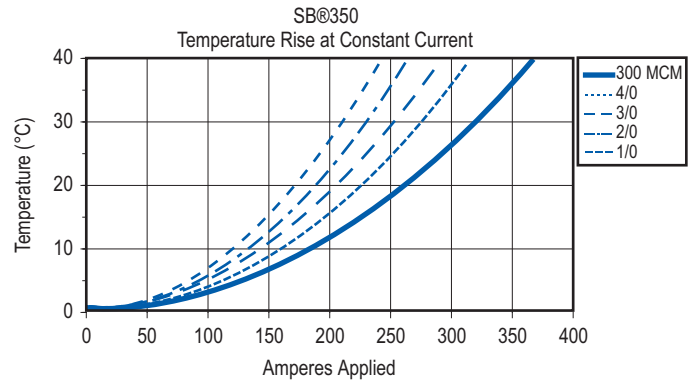

DIMENSIONS

SB® Contacts

Part Number	-A-		-B-		-C-		-D-		-E-	
	mm	in.	mm	in.	mm	in.	mm	in.	mm	in.
907	75.1	2.96	16.3	0.64	12.4	0.49	32.8	1.29	20.6	0.81
908	75.1	2.96	19.1	0.75	16.3	0.64	32.8	1.29	20.6	0.81
910	73.9	2.91	22.2	0.87	19.1	0.75	32.5	1.28	20.6	0.81
916	75.1	2.96	17.9	0.7	14.7	0.58	32.8	1.29	20.6	0.81
917	73.9	2.91	13	0.51	11.1	0.44	31.8	1.25	20.6	0.81
350BBS	131.7	5.19	22.3	0.88	17.0	0.67	N/A	#3/8-19Thd.	2.5	0.10

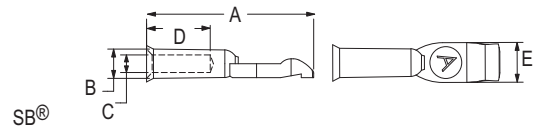

Bus Bar

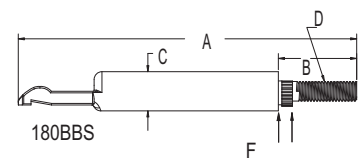

Bus Bar Mounting Table

Part Number	- E -	- F -	- J -
	mm in.	mm in.	mm in.
350BBS	113.0 4.45	5.1 0.20	3.0-19.6 0.12-0.77

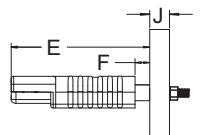

HEADQUARTERS: 13 Pratts Junction Road, P.O. Box 579, Sterling, MA 01564 T:978-422-3600 F:978-422-3700

EUROPE: Rathealy Road, Fermoy Co. Cork, Ireland T:353-(0)25-32277 F:353-(0)25-32296

ASIA/PACIFIC: IDEAL Anderson Asia Pacific Ltd., Unit 922-928 Topsail Plaza, 11 On Sum Street, Shatin N.T., Hong Kong T:852-2636-0836 F:852-2635-9036

CHINA: IDEAL Anderson Technologies (Shenzhen) Ltd., Block A8 Tantou W. Ind. Par, Songgang Baoan District, Shenzhen, P.R. China 51810 T: 86-755-2768-2118 F: 86-755-2768-2218

TAIWAN: IDEAL Anderson Asia Pacific Ltd., Taiwan Branch, 4F-2, No.116, Dadun 20th St., Situn District, Taichung City 407, Taiwan (R.O.C.) T: 886-4-2310-6451 F:886-4-2310-6460