

ACNT-H61L

Low Power 10-MBd Digital CMOS Optocoupler in 15-mm Stretched SO8 Package

Description

The Broadcom® ACNT-H61L is a stretched wide optically coupled optocoupler that combines a light-emitting diode and an integrated high gain photo detector to address the low power need for isolated interface. The optocoupler consumes extremely low power, at maximum 2 mA across temperature. The LED forward current operates from 4.5 mA.

This optocoupler supports both a 3.3V and a 5V supply voltage with guaranteed AC and DC operational parameters from temperature range -40°C to $+105^{\circ}\text{C}$. The output of the detector IC is a CMOS output. The internal Faraday shield provides a guaranteed common-mode transient immunity specification of 20 kV/ μs .

The ACNT-H61L with 15-mm stretched SO-8 package and high voltage insulation capability is suitable for isolated communicate logic interface and control in high-voltage power systems such as 690V_{AC} drives, renewable inverters, and medical equipment.

Figure 1: Functional Diagram

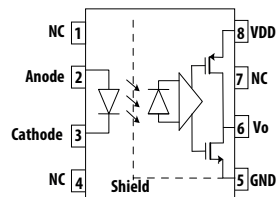

Table 1: Truth Table (Positive Logic)

LED	Output V _O
ON	L
OFF	H

A 0.1- μF bypass capacitor must be connected between pins V_{DD} and GND.

Features

- Low I_{DD} power supply consumption: 2 mA max.
- Input current capability: 4.5 mA min.
- Package: 15-mm stretched SO-8.
- 20 kV/ μs minimum common-mode rejection (CMR) at V_{CM} = 1000 V.
- High speed: 10 MBd min.
- Guaranteed AC and DC performance over wide temperature range: -40°C to $+105^{\circ}\text{C}$.
- Safety approval:
 - UL 1577 recognized: 7500 V_{rms} for 1 minute
 - CSA approval
 - IEC/EN 60747-5-5 V_{IORM} = 2262 V_{peak} for reinforced insulation

Applications

- Communication Interface: RS-485, CAN bus
- Digital isolation for A/D, D/A conversion
- High-voltage power systems, e.g., 690V drives
- Renewable energy inverters
- Medical imaging and patient monitoring

CAUTION! It is advised that normal static precautions be taken in handling and assembly of this component to prevent damage and/or degradation that may be induced by ESD. The components featured in this data sheet are not to be used in military or aerospace applications or environments.

Ordering Information

ACNT-H61L is UL Recognized with 7500 V_{rms} for 1 minute per UL 1577.

Part Number	Option RoHS Compliant	Package	Surface Mount	Tape & Reel	UL 1577	IEC/EN 60747-5-5	Quantity
ACNT-H61L	-000E	15-mm	X		X	X	80 per tube
	-500E	Stretched SO8	X	X	X	X	1000 per reel

To order, choose a part number from the Part Number column and combine with the desired option from the Option column to form an order entry.

Package Outline Drawing

ACNT-H61L Stretched SO-8 Package

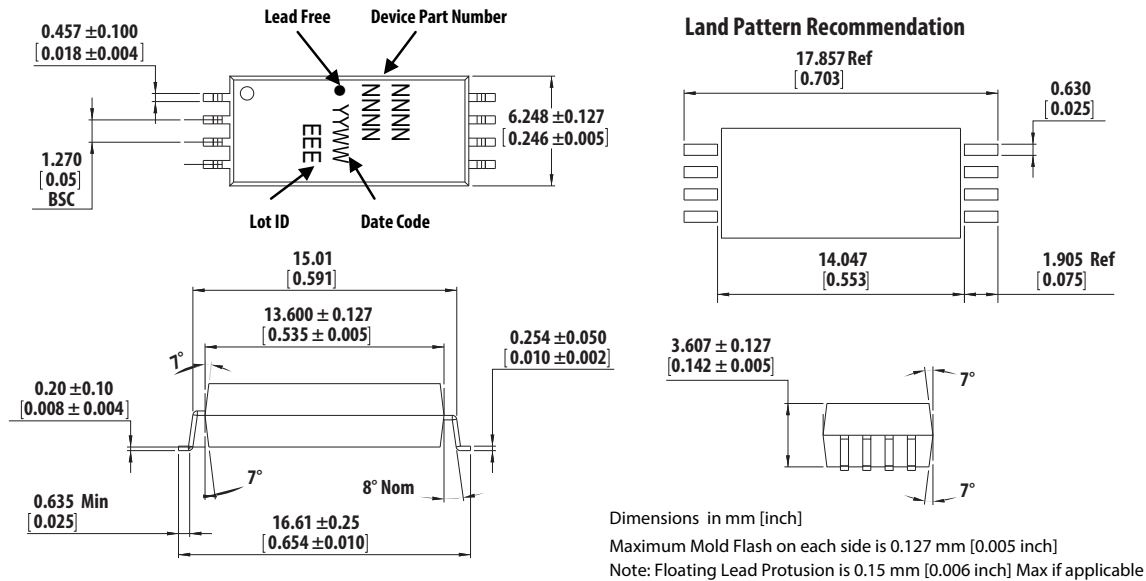

Solder Reflow Profile

Recommended reflow condition as per JEDEC Standard, J-STD-020 (latest revision). Non-halide flux should be used.

Regulatory Information

The ACNT-H61L is pending approval by the following organizations.

IEC/EN 60747-5-5	
UL	Approval under UL 1577, component recognition program up to V _{ISO} = 7500 V _{RMS} File E55361.
CSA	Approval under CSA Component Acceptance Notice #5, File CA 88324.

Insulation and Safety Related Specifications

Parameter	Symbol	ACNT-H61L	Unit	Conditions
Minimum External Air Gap (External Clearance)	L(101)	14.2	mm	Measured from input terminals to output terminals, shortest distance through air.
Minimum External Tracking (External Creepage)	L(102)	15	mm	Measured from input terminals to output terminals, shortest distance path along body.
Minimum Internal Plastic Gap (Internal Clearance)		0.5	mm	Through insulation distance conductor to conductor, usually the straight line distance thickness between the emitter and detector.
Tracking Resistance (Comparative Tracking Index)	CTI	>300	V	DIN IEC 112/VDE 0303 Part 1.
Isolation Group		IIIa		Material Group (DIN VDE 0110, 1/89, Table 1.)

IEC/EN 60747-5-5 Insulation Characteristics^a

Description	Symbol	Characteristic	Unit
Installation Classification per DIN VDE 0110/39, Table 1 for rated mains voltage $\leq 600 V_{rms}$ for rated mains voltage $\leq 1000 V_{rms}$		I – IV I – IV	
Climatic Classification		40/105/21	
Pollution Degree (DIN VDE 0110/39)		2	
Maximum Working Insulation Voltage	V_{IORM}	2262	V_{peak}
Input to Output Test Voltage, Method b ^a $V_{IORM} \times 1.875 = V_{PR}$, 100% Production Test with $t_m = 1$ sec, Partial Discharge < 5 pC	V_{PR}	4241	V_{peak}
Input to Output Test Voltage, Method a ^a $V_{IORM} \times 1.6 = V_{PR}$, Type and Sample Test, $t_m = 10$ sec, Partial Discharge < 5 pC	V_{PR}	3619	V_{peak}
Highest Allowable Overvoltage (Transient Overvoltage $t_{ini} = 60$ sec)	V_{IOTM}	12000	V_{peak}
Safety-limiting Values – Maximum Values Allowed in the Event of a Failure Case Temperature Input Current Output Power	T_S $I_{S, INPUT}$ $P_{S, OUTPUT}$	150 400 1000	$^{\circ}C$ mA mW
Insulation Resistance at T_S , $V_{IO} = 500V$	R_S	$>10^9$	Ω

a. Refer to the optocoupler section of the *Isolation and Control Components Designer's Catalog*, under Product Safety Regulations section, (IEC/EN 60747-5-5) for a detailed description of Method a and Method b partial discharge test profiles.

Absolute Maximum Ratings

Parameter	Symbol	Min.	Max.	Units	Conditions
Storage Temperature	T_S	-55	125	°C	—
Operating Temperature	T_A	-40	105	°C	—
Reverse Input Voltage	V_R	—	5	V	—
Supply Voltage	V_{DD}	—	6.5	V	—
Average Forward Input Current	I_F	—	10	mA	—
Peak Forward Input Current	$I_{F(TRAN)}$	—	1	A	<1 μ s Pulse Width, <300 pulses per second
		—	80	mA	<1 μ s Pulse Width, <10% Duty Cycle
Output Current	I_O	—	10	mA	—
Output Voltage	V_O	-0.5	$V_{DD} + 0.5$	V	—
Input Power Dissipation	P_I	—	20	mW	—
Output Power Dissipation	P_O	—	22	mW	—
Lead Solder Temperature	T_{LS}	260°C for 10 seconds, 1.6 mm below seating plane			
Solder Reflow Temperature Profile	—	See Solder Reflow Profile .			

Recommended Operating Conditions

Parameter	Symbol	Min.	Max.	Units
Operating Temperature	T_A	-40	105	°C
Input Current, Low Level	I_{FL}	0	250	μ A
Input Current, High Level	I_{FH}	4.5	8	mA
Power Supply Voltage	V_{DD}	2.7	5.5	V
Forward Input Voltage	V_F (OFF)	—	0.8	V

Electrical Specifications (DC)

Over recommended temperature ($T_A = -40^\circ\text{C}$ to $+105^\circ\text{C}$), supply voltage ($2.7\text{V} \leq V_{DD} \leq 5.5\text{V}$). All typical specifications are at $V_{DD} = 5\text{V}$, $T_A = 25^\circ\text{C}$.

Parameter	Symbol	Min.	Typ.	Max.	Units	Test Conditions	Figure
Input Forward Voltage	V_F	1.20	1.38	1.85	V	$I_F = 7\text{ mA}$	2, 3
Input Reverse Breakdown Voltage	BV_R	7	—	—	V	$I_R = 10\text{ }\mu\text{A}$	
Logic High Output Voltage	V_{OH}	$V_{DD} - 0.1$	V_{DD}	—	V	$I_F = 0\text{ mA}$, $V_I = 0\text{V}$, $I_O = -20\text{ }\mu\text{A}$	
		$V_{DD} - 1.0$	V_{DD}	—	V	$I_F = 0\text{ mA}$, $V_I = 0\text{V}$, $I_O = -3.2\text{ mA}$	
Logic Low Output Voltage	V_{OL}	—	0.02	0.1	V	$I_F = 7\text{ mA}$, $V_I = 5\text{V}/3.3\text{V}$, $I_O = 20\text{ }\mu\text{A}$	
		—	0.2	0.4	V	$I_F = 7\text{ mA}$, $V_I = 5\text{V}/3.3\text{V}$, $I_O = 3.2\text{ mA}$	
Input Threshold Current	I_{TH}	—	0.7	3.8	mA	—	4
Logic Low Output Supply Current	I_{DDL}	—	1	2	mA	—	5
Logic High Output Supply Current	I_{DDH}	—	1	2	mA	—	6
Input Capacitance	C_{IN}	—	20	—	pF	$f = 1\text{ MHz}$, $V_F = 0\text{V}$	
Input Diode Temperature Coefficient	$\Delta V_F / \Delta T_A$	—	-1.5	—	mV/ $^\circ\text{C}$	$I_F = 7\text{ mA}$	

Switching Specifications (AC)

Over recommended temperature ($T_A = -40^\circ\text{C}$ to $+105^\circ\text{C}$), supply voltage ($2.7\text{V} \leq V_{DD} \leq 5.5\text{V}$). All typical specifications are at $V_{DD} = 5\text{V}$, $T_A = 25^\circ\text{C}$.

Parameter	Symbol	Min.	Typ.	Max.	Units	Test Conditions
Propagation Delay Time to Logic Low Output ^a	t_{PHL}	—	40	100	ns	$I_F = 7\text{ mA}$, $V_I = 3.3\text{V}/5\text{V}$, $C_L = 15\text{ pF}$, CMOS Signal Levels. Figures 7, 8, 9, 10
Propagation Delay Time to Logic High Output ^a	t_{PLH}	—	40	100	ns	
Pulse Width	t_{PW}	100	—	—	ns	
Pulse Width Distortion ^b	PWD	—	5	40	ns	
Propagation Delay Skew ^c	t_{PSK}	—	—	40	ns	
Output Rise Time (10% to 90%)	t_R	—	10	—	ns	
Output Fall Time (90% to 10%)	t_F	—	10	—	ns	
Static Common-Mode Transient Immunity at Logic High Output ^d	$ CM_H $	20	35	—	kV/ μs	$V_{CM} = 1000\text{V}$, $T_A = 25^\circ\text{C}$, $I_F = 0\text{ mA}$, $V_I = 0\text{V}$, $C_L = 15\text{ pF}$, CMOS Signal Levels
Static Common-Mode Transient Immunity at Logic Low Output ^e	$ CM_L $	20	35	—	kV/ μs	$V_{CM} = 1000\text{ V}$, $T_A = 25^\circ\text{C}$, $I_F = 7\text{ mA}$, $V_I = 5\text{V}/3.3\text{V}$, $C_L = 15\text{ pF}$, CMOS Signal Levels
Dynamic Common-Mode Transient Immunity ^f	CMRD	—	35	—	kV/ μs	$V_{CM} = 1000\text{V}$, $T_A = 25^\circ\text{C}$, $I_F = 7\text{ mA}$, $V_I = 5\text{V}/3.3\text{V}$, 10-MBd data rate, the absolute increase of PWD <10 ns

- t_{PHL} propagation delay is measured from the 50% (V_{in} or I_F) on the rising edge of the input pulse to the 50% V_{DD} of the falling edge of the V_O signal. t_{PLH} propagation delay is measured from the 50% (V_{in} or I_F) on the falling edge of the input pulse to the 50% level of the rising edge of the V_O signal.
- PWD is defined as $|t_{PHL} - t_{PLH}|$.
- t_{PSK} is equal to the magnitude of the worst-case difference in t_{PHL} and/or t_{PLH} that is seen between units at any given temperature within the recommended operating conditions.
- CM_H is the maximum tolerable rate of rise of the common-mode voltage to assure that the output remains in a high logic state.
- CM_L is the maximum tolerable rate of fall of the common-mode voltage to assure that the output remains in a low logic state.
- CMRD is the maximum tolerable rate of the common-mode voltage during data transmission to assure that the absolute increase of the PWD is less than 10 ns.

Package Characteristics

All typical at $T_A = 25^\circ\text{C}$.

Parameter	Symbol	Min.	Typ.	Max.	Units	Test Conditions
Input-Output Insulation	V_{ISO}	7500	—	—	Vrms	RH < 50% for 1 min. $T_A = 25^\circ\text{C}$
Input-Output Resistance	R_{I-O}	—	10^{12}	—	Ω	$V_{I-O} = 500\text{V}$
Input-Output Capacitance	C_{I-O}	—	0.6	—	pF	$f = 1\text{ MHz}$, $T_A = 25^\circ\text{C}$

Figure 2: Typical Input Diode Forward Characteristic

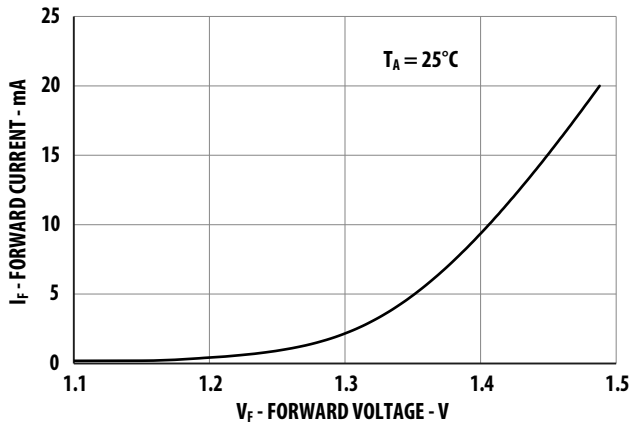

Figure 3: Typical V_F Versus Temperature

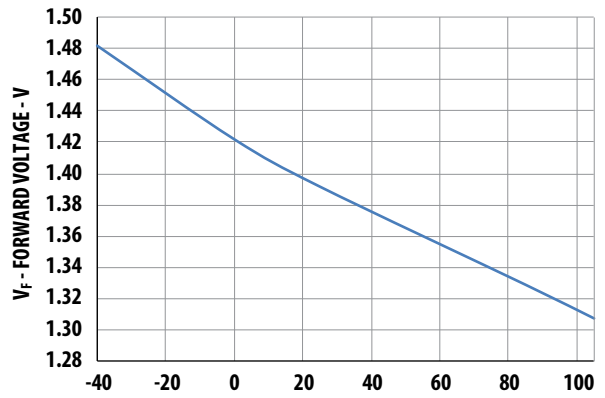

Figure 4: Typical Input Threshold Current I_{TH} Versus Temperature

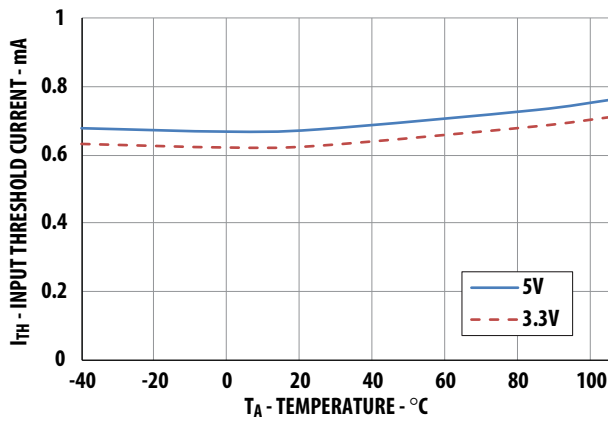

Figure 5: Typical Logic Low Output Supply Current I_{DDL} Versus Temperature

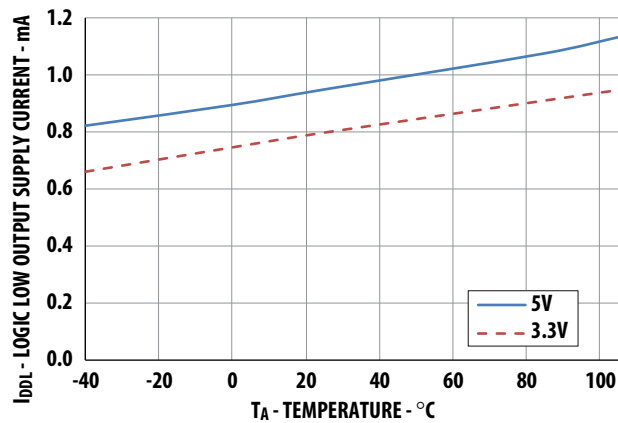

Figure 6: Typical Logic High Output Supply Current I_{DDH} Versus Temperature

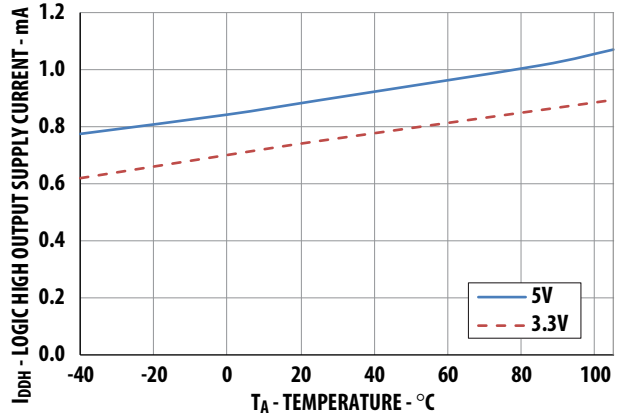

Figure 7: Typical Switching Speed Versus Pulse Input Current at 5V Supply Voltage

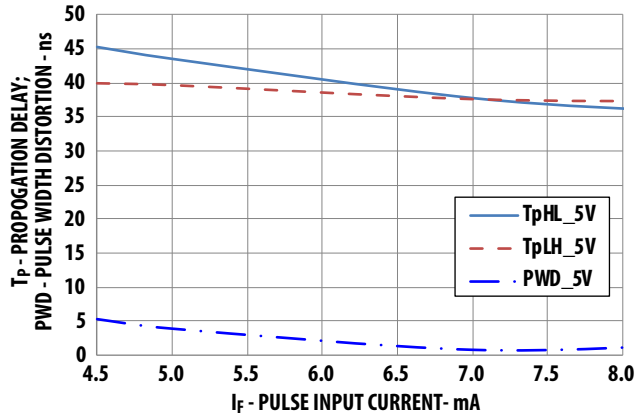

Figure 8: Typical Switching Speed Versus Pulse Input Current at 3.3V Supply Voltage

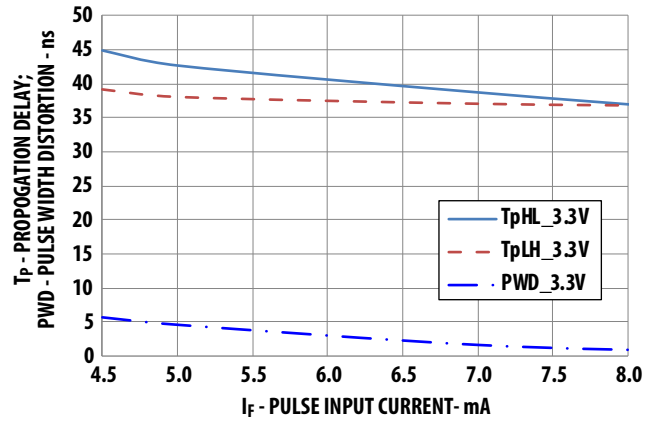

Figure 9: Typical Switching Speed Versus Temperature at 5V Supply Voltage

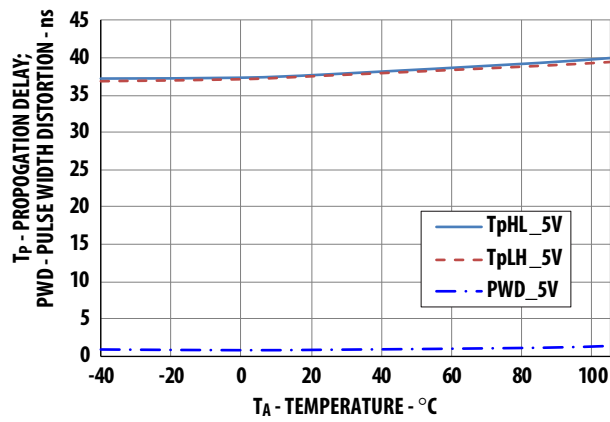
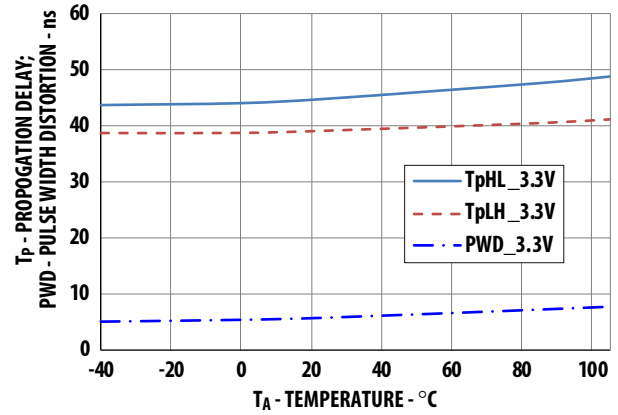

Figure 10: Typical Switching Speed Versus Temperature at 3.3V Supply Voltage



Bypassing and PC Board Layout

The external components required for proper operation are the input limiting resistors and the output bypass capacitor. Capacitor values should be 0.1 μ F and should be placed as close as possible to the power-supply pins of the optocoupler.

Propagation Delay, Pulse-Width Distortion, and Propagation Delay Skew

Propagation delay is a figure of merit that describes how quickly a logic signal propagates through a system. The propagation delay from low to high (t_{PLH}) is the amount of time required for an input signal to propagate to the output, causing the output to change from low to high.

Similarly, the propagation delay from high to low (t_{PHL}) is the amount of time required for the input signal to propagate to the output, causing the output to change from high to low (see Figure 12).

Figure 11: Recommended Printed Circuit Board Layout

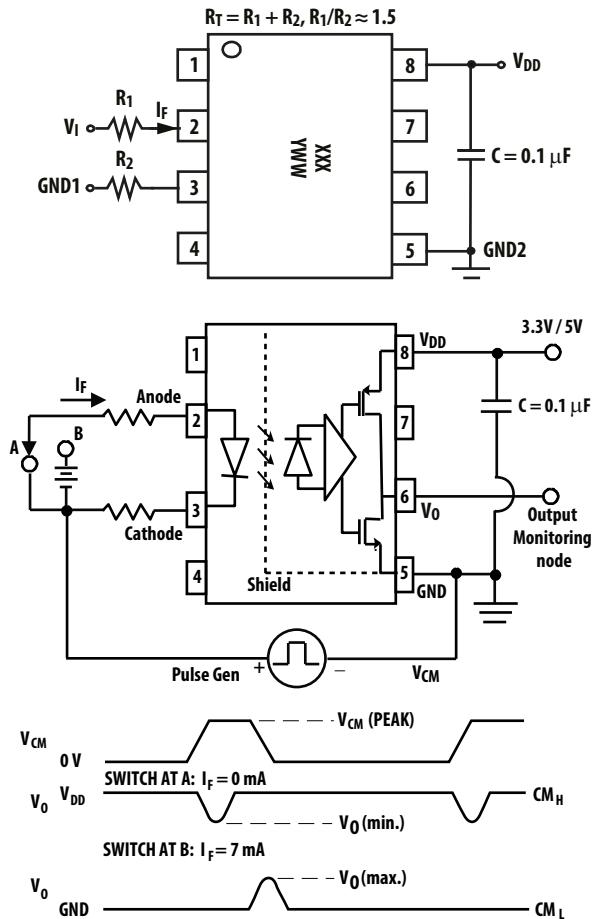

Pulse-width distortion (PWD) results when t_{PLH} and t_{PHL} differ in value. PWD is defined as the difference between t_{PLH} and t_{PHL} . This parameter determines the maximum data rate capability of a transmission system. PWD can be expressed in percent by dividing the PWD (in ns) by the minimum pulse width (in ns) being transmitted. Typically, PWD in the order of 20% to 30% of the minimum pulse width is tolerable; the exact figure depends on the particular application (RS232, RS422, T-1, and so on).

Propagation delay skew, t_{PSK} , is an important parameter to consider in parallel data applications where synchronization of signals on parallel data lines is a concern. If the parallel data is being sent through a group of optocouplers, differences in propagation delays cause the data to arrive at the outputs of the optocouplers at different times. If this difference in propagation delays is large enough, it determines the maximum rate at which parallel data can be sent through the optocouplers.

Propagation delay skew is defined as the difference between the minimum and maximum propagation delays, either t_{PLH} or t_{PHL} , for any given group of optocouplers that are operating under the same conditions (i.e., the same supply voltage, output load, and operating temperature). As illustrated in Figure 12, if the inputs of a group of optocouplers are switched either ON or OFF at the same time, t_{PSK} is the difference between the shortest propagation delay, either t_{PLH} or t_{PHL} , and the longest propagation delay, either t_{PLH} or t_{PHL} . As mentioned earlier, t_{PSK} can determine the maximum parallel data transmission rate.

Figure 13 is the timing diagram of a typical parallel data application with both the clock and the data lines being sent through optocouplers. The figure shows data and clock signals at the inputs and outputs of the optocouplers. To obtain the maximum data transmission rate, both edges of the clock signal are being used to clock the data; if only one edge were used, the clock signal would need to be twice as fast.

Propagation delay skew represents the uncertainty of where an edge might be after being sent through an optocoupler. Figure 13 shows that there is uncertainty in both the data and the clock lines. It is important that these two areas of uncertainty not overlap; otherwise, the clock signal might arrive before all of the data outputs have settled, or some of the data outputs may start to change before the clock signal has arrived.

With these considerations, the absolute minimum pulse width that can be sent through optocouplers in a parallel application is twice t_{PSK} . A cautious design should use a slightly longer pulse width to ensure that any additional uncertainty in the rest of the circuit does not cause a problem.

The t_{PSK} specified optocouplers offer the advantages of guaranteed specifications for propagation delays, pulse-width distortion, and propagation delay skew over the recommended temperature and power supply ranges.

Figure 12: Propagation Delay Skew Waveform

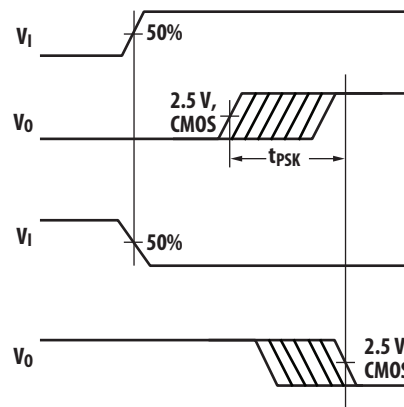
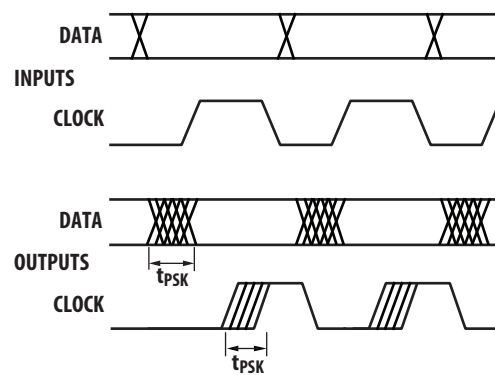

Figure 13: Parallel Data Transmission Example



Optocoupler CMR Performance

The principal protection against common-mode noise comes down to the fundamental isolation properties of the optocoupler; this, in turn, is directly related to the input-output leakage capacitance of the optocoupler.

To provide maximum protection to circuitry connected to the input or output of the optocoupler, the leakage capacitance is minimized by having large separation distances at all points in the optocoupler construction, including the LED/photodiode interface.

In addition to the constructional design, additional circuit design steps are taken to further mitigate the effects of common-mode noise. The most important of these is the use of a Faraday shield on the photodetector stage. This Faraday shield is effective in optocouplers because the internal modulation frequency (light) is many orders of magnitude higher than the common-mode noise frequency.

Application Level CMR Performance

In application, it is desirable that the optocoupler's common-mode isolation perform as close as possible to that indicated in the data sheet specifications.

The first step in meeting this goal is to ensure maintaining maximum separation between PCB interconnects on either side of the optocoupler and avoid routing tracks beneath the optocoupler. Nonetheless, it is inevitable that a certain amount of CMR noise is coupled into the inputs, which can potentially result in false-triggering of the input.

This problem is frequently observed in devices with input high input impedance such as CMOS buffered inputs in either optocoupler or alternate isolator technologies. In some cases, this not only causes momentary missing pulses but in some technologies can even cause input circuitry to latch-up.

The ACNT-H61L does not face an input latch-up issue even at very high CMR levels, such as those experienced in end equipment level tests (for example IEC 61000-4-4) due to the simple diode structure of the LED.

In some cases, achieving the rated data sheet CMR performance levels is not possible in the intended application, often because of the practical need to actually connect the isolator input to the output of a dynamically changing signal rather than tying the input statically to VDD1 or GND1.

This specsmanship issue is often observable with alternative isolators utilizing AC encoding techniques.

To address this requirement for clear transparency on the achievable end application performance, the ACNT-H61L optocoupler includes an additional typical performance indication of the dynamic CMR in the electrical parameter table. This information indicates the achievable CMR performance while the input is being toggled on or off during the occurrence of a CMR transient. The logic output of the optocoupler is mainly controlled by the level of the LED current. Due to the short transition rise/fall time of the LED current (approximately 10 ns), the dynamic noise immunity is essentially the same as the static noise immunity.

To achieve this goal of meeting the maximum inherent CMR capabilities, some simple consideration must be given to the operation of the LED at the application level.

In particular, you must ensure that the LED stays either on or off during a CMR transient.

The following common design techniques are sometimes used to meet this goal:

- Keeping LED On:
 - Overdrive the LED with a higher than required forward current.
- Keeping LED Off:
 - Reverse bias the LED during the off state.
 - Minimize the off state impedance across the anode and cathode of the LED during the off state.

All of these methods can achieve the full CMR capabilities of the ACNT-H61L. But they do come at the cost of practical implementation issues or a compromise in power consumption.

An effective method to meet the goal of maintaining the LED status during a CMR event with no other design compromises requires the addition of a single low-cost component (resistor).

This CMR optimization method fundamentally makes use of the differential input capability of the LED input. By ensuring the common-mode impedance on both the cathode and anode of the LED are balanced, it effectively nullifies the effect of a CMR transient on the LED. This is most easily achieved by splitting the input bias resistor into two (as shown in [Figure 11](#)).

Split Resistor Configuration

[Figure 14](#) shows the recommended drive circuit for the ACNT-H61L for optimal common-mode rejection performance. Two LED-current setting resistors are used to balance the common-mode impedance at LED anode and cathode. Common-mode transients can capacitively couple from the LED anode (or cathode) to the output-side ground causing current to be shunted away from the LED (which can be bad if the LED is on) or conversely cause current to be injected into the LED (bad if the LED is meant to be off). [Figure 15](#) shows the parasitic capacitances that exist between LED anode/cathode and output ground (C_{LA} and C_{LC}).

Table 2: Effects of Common-Mode Pulse Direction on Transient I_{LED}

If dV_{CM}/dt Is:	Then I_{LP} Flows:	And I_{LN} Flows:	If $I_{LP} < I_{LN}$, LED I_F Current Is Momentarily:	If $I_{LP} > I_{LN}$, LED I_F Current Is Momentarily:
Positive (>0)	Away from LED anode through C_{LA}	Away from LED cathode through C_{LC}	Increased	Decreased
Negative (<0)	Toward LED anode through C_{LA}	Toward LED cathode through C_{LC}	Decreased	Increased

Broadcom, the pulse logo, Connecting everything, Avago Technologies, Avago, and the A logo are among the trademarks of Broadcom and/or its affiliates in the United States, certain other countries, and/or the EU.

Copyright © 2016–2020 Broadcom. All Rights Reserved.

The term “Broadcom” refers to Broadcom Inc. and/or its subsidiaries. For more information, please visit www.broadcom.com.

Broadcom reserves the right to make changes without further notice to any products or data herein to improve reliability, function, or design. Information furnished by Broadcom is believed to be accurate and reliable. However, Broadcom does not assume any liability arising out of the application or use of this information, nor the application or use of any product or circuit described herein, neither does it convey any license under its patent rights nor the rights of others.



Mouser Electronics

Authorized Distributor

Click to View Pricing, Inventory, Delivery & Lifecycle Information:

[Broadcom Limited:](#)

[ACNT-H61L-500E](#)